

Series LF 63 DN20 PN25

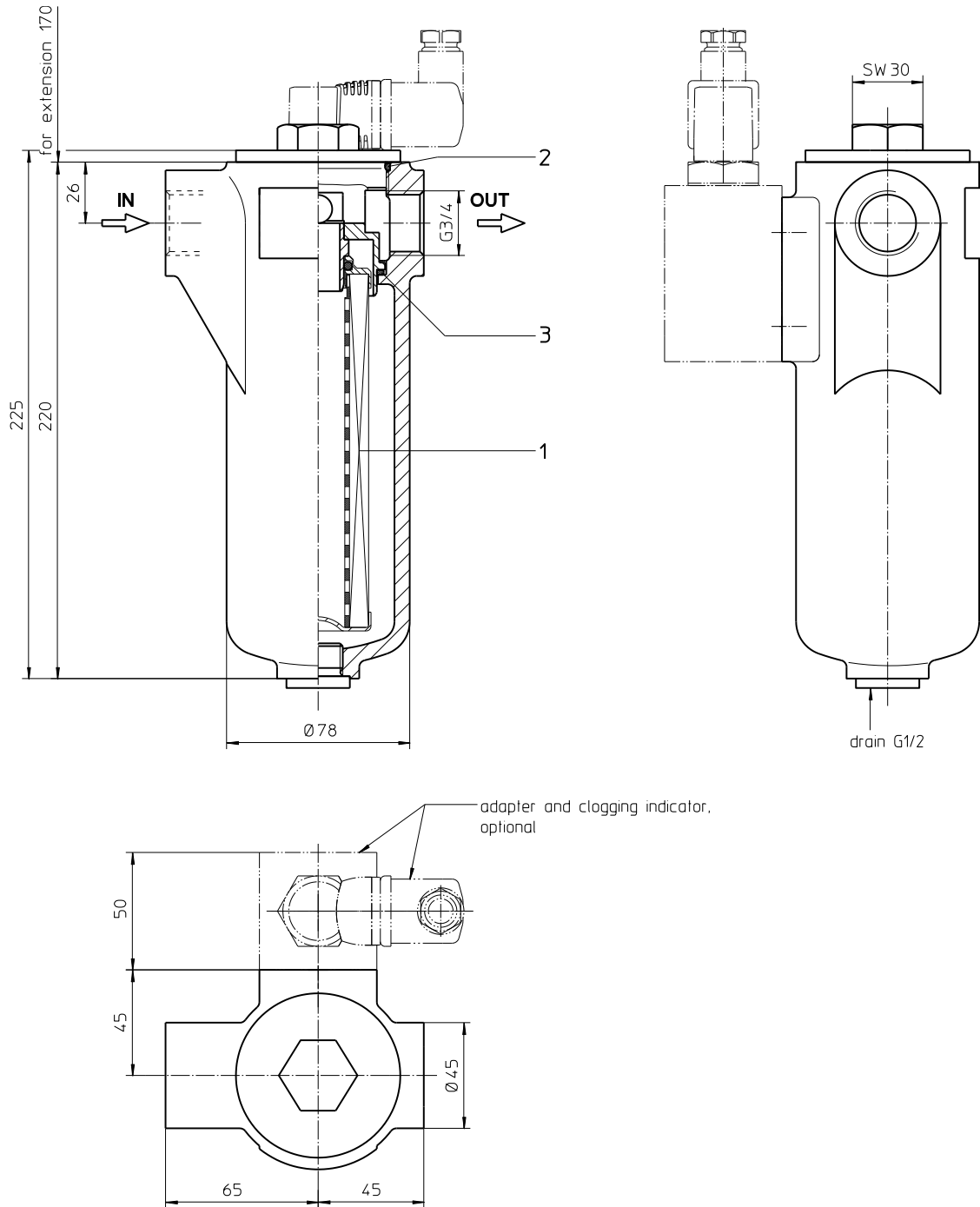

Weight: approx. 2,5 kg

Dimensions: mm

Designs and performance values are subject to change.

Pressure Filter

Series LF 63

DN20 PN25

Description:

In-line filters of the type LF 63 are suitable for a working pressure up to 25 bar. Pressure peaks are absorbed with a sufficient margin of safety. It can be used as suction filter, pressure filter and return-line filter.

The filter element consists of star-shaped, pleated filter material, which is supported on the inside by a perforated core tube and is bonded to the end caps with a high-quality adhesive. The flow direction is from outside to inside.

For cleaning the stainless steel mesh element (see special leaflets 21070-4 and 39448-4) or changing the filter element, remove the cover and take out the element. The mesh elements are not guaranteed to maintain 100% performance after cleaning.

For filtration finer than 40 µm, use the disposable elements made of microglass. Filter elements as fine as 5 µm(c) are available; finer filter elements are available upon request.

Eaton filter elements are known for a high intrinsic stability and an excellent filtration capability, a high dirt-retaining capacity and a long service life.

Eaton filter can be used for petroleum-based fluids, HW emulsions, water glycols, most synthetic fluids and lubrication fluids. Consult factory for specific fluid applications.

The internal valve is integrated in the filter cover. After reaching the bypass pressure setting, the bypass valve will send unfiltered partial flow around the filter.

Ship classifications available upon request.

Type index:

Complete filter: (ordering example)

LF. 63. 10VG. 30. E. P. - . G. 4. - . - . - . AE

1	2	3	4	5	6	7	8	9	10	11	12	13
---	---	---	---	---	---	---	---	---	----	----	----	----

- 1 | series:**
LF = in-line filter
- 2 | nominal size:** 63
- 3 | filter-material:**
130G, 80G, 40G, 25G stainless steel wire mesh
25VG, 16VG, 10VG, 6VG, 3VG microglass
25API, 10API microglass according to API
- 4 | filter element collapse rating:**
30 = Δp 30 bar
- 5 | filter element design:**
E = single end open
- 6 | sealing material:**
P = Nitrile (NBR)
V = Viton (FPM)
- 7 | filter element specification:**
- = standard
VA = stainless steel
IS06 = for HFC application, see sheet-no. 31601
- 8 | process connection:**
G = thread according to DIN 3852 T2
- 9 | process connection size:**
4 = G ¾
- 10 | filter housing specification:**
- = standard
- 11 | pressure vessel specification:**
- = standard (PED 2014/68/EU)
- 12 | internal valve:**
- = without
S1 = with bypass valve Δp 3,5 bar
- 13 | clogging indicator or clogging sensor:**
- = without
AOR = visual, see sheet-no.1606
AOC = visual, see sheet-no.1606
AE = visual-electric, see sheet-no.1615
VS5 = electronic, see sheet-no.1619

To add an indicator/sensor to your filter, use the corresponding indicator data sheet to find the indicator details and add them to the filter assembly model code.

Filter element: (ordering example)

01NL. 63. 10VG. 30. E. P. -

1	2	3	4	5	6	7
---	---	---	---	---	---	---

- 1 | series:**
01NL = standard filter element according to DIN 24550, T3
- 2 | nominal size:** 63
- 3 | - 7 |** see type index complete filter

Technical data:

operating temperature:	-10 °C to +100 °C
operating medium:	mineral oil, other media on request
max. operating pressure:	25 bar
test pressure:	36 bar
process connection:	thread connection according to DIN 3852 T2
housing material:	aluminium-cast, steel (filter cover)
sealing material:	Nitrile (NBR) or Viton (FPM), other materials on request
installation position:	vertical
measuring connections:	G ¼
drain connection:	G ½
volume tank:	0,7 l

Classified under the Pressure Equipment Directive 2014/68/EU for mineral oil (fluid group 2), Article 4, Para. 3.
Classified under ATEX Directive 2014/34/EU according to specific application (see questionnaire sheet-no. 34279-4).

Pressure drop flow curves:

Filter calculation/sizing

The pressure drop of the assembly at a given flow rate Q is the sum of the housing Δp and the element Δp and is calculated as follows:

$$\Delta p_{assembly} = \Delta p_{housing} + \Delta p_{element}$$

$$\Delta p_{housing} = (\text{see } \Delta p = f(Q) \text{ - characteristics})$$

$$\Delta p_{element} (mbar) = Q \left(\frac{l}{min} \right) \times \frac{MSK (mbar)}{10 (l/min)} \times v \left(\frac{mm^2}{s} \right) \times \frac{p}{0,876} \left(\frac{kg}{dm^3} \right)$$

For ease of calculation our Filter Selection tool is available online at www.eaton.com/hydraulic-filter-evaluation

Material gradient coefficients (MSK) for filter elements

The material gradient coefficients in mbar/(l/min) apply to mineral oil (HLP) with a density of 0,876 kg/dm³ and a kinematic viscosity of 30 mm²/s (139 SUS). The pressure drop changes proportionally to the change in kinematic viscosity and density.

LF	VG					G			API	
	3VG	6VG	10VG	16VG	25VG	25G	40G	80G	10API	25API
63	3,441	2,389	1,530	1,332	0,910	0,0924	0,0862	0,0591	1,085	0,568

$\Delta p = f(Q)$ – characteristics according to ISO 3968

The pressure drop characteristics apply to mineral oil (HLP) with a density of 0,876 kg/dm³. The pressure drop changes proportionally to the density.

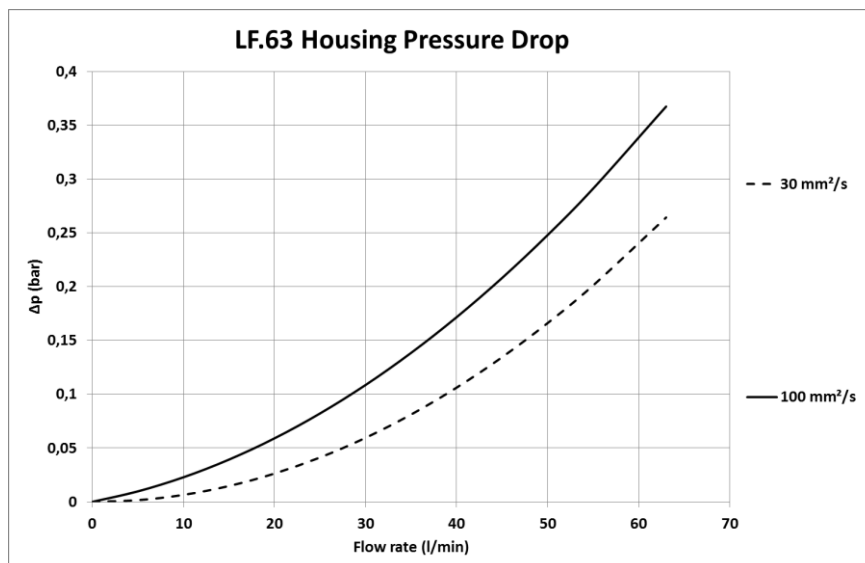

Symbols:

without indicator

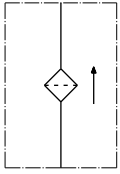

with
bypass valve

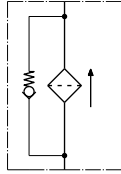

with electric
indicator
AE30 / AE40

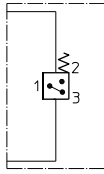

with visual-electric
indicator
AE50 / AE62

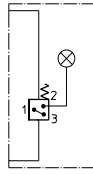

with visual-electric
indicator
AE70 / AE80 / AE90

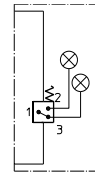

with visual
indicator
AOR/AOC

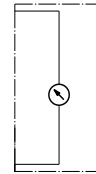

with electronic
sensor
VS5

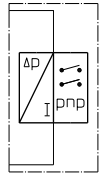

Spare parts:

item	qty.	designation	dimension	article no.	
1	1	filter element	01NL.63...		
3	1	O-ring	56 x 3	305072 (NBR)	305322 (FPM)
4	1	O-ring	48 x 3	304357 (NBR)	304404 (FPM)

Test methods:

Filter elements are tested according to the following ISO standards:

ISO 2941	Verification of collapse/burst resistance
ISO 2942	Verification of fabrication integrity
ISO 2943	Verification of material compatibility with fluids
ISO 3723	Method for end load test
ISO 3724	Verification of flow fatigue characteristics
ISO 3968	Evaluation of pressure drop versus flow characteristics
ISO 16889	Multi-pass method for evaluating filtration performance

North America
44 Apple Street
Tinton Falls, NJ 07724
Toll Free: 800 656-3344
(North America only)
Tel: +1 732 212-4700

Greater China
No. 7, Lane 280,
Linhong Road
Changning District, 200335
Shanghai, P.R. China
Tel: +86 21 5200-0099

Europe/Africa/Middle East
Auf der Heide 2
53947 Nettersheim, Germany
Tel: +49 2486 809-0

Friedensstraße 41
68804 Altlußheim, Germany
Tel: +49 6205 2094-0

An den Nahewiesen 24
55450 Langenlonsheim, Germany
Tel: +49 6704 204-0

Asia-Pacific
100G Pasir Panjang Road
#07-08 Interlocal Centre
Singapore 118523
Tel: +65 6825-1668

**For more information, please
email us at filtration@eaton.com
or visit www.eaton.com/filtration**

© 2021 Eaton. All rights reserved. All trademarks and registered trademarks are the property of their respective owners. All information and recommendations appearing in this brochure concerning the use of products described herein are based on tests believed to be reliable. However, it is the user's responsibility to determine the suitability for his own use of such products. Since the actual use by others is beyond our control, no guarantee, expressed or implied, is made by Eaton as to the effects of such use or the results to be obtained. Eaton assumes no liability arising out of the use by others of such products. Nor is the information herein to be construed as absolutely complete, since additional information may be necessary or desirable when particular or exceptional conditions or circumstances exist or because of applicable laws or government regulations.