

Series EDA 633

NPS 3" CLASS 150-300 PSI

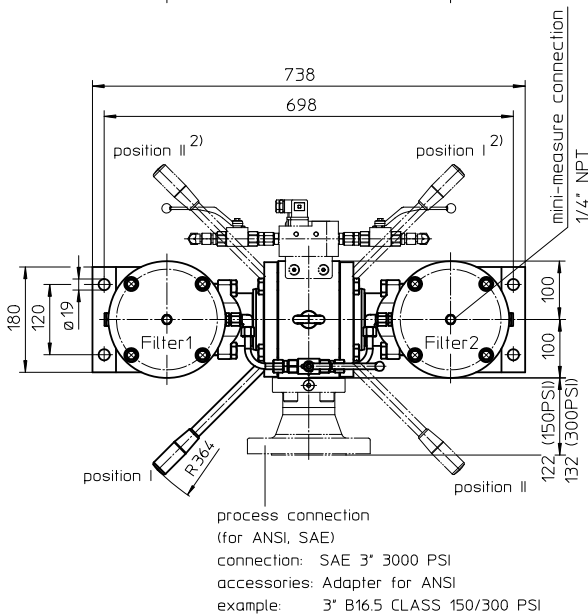
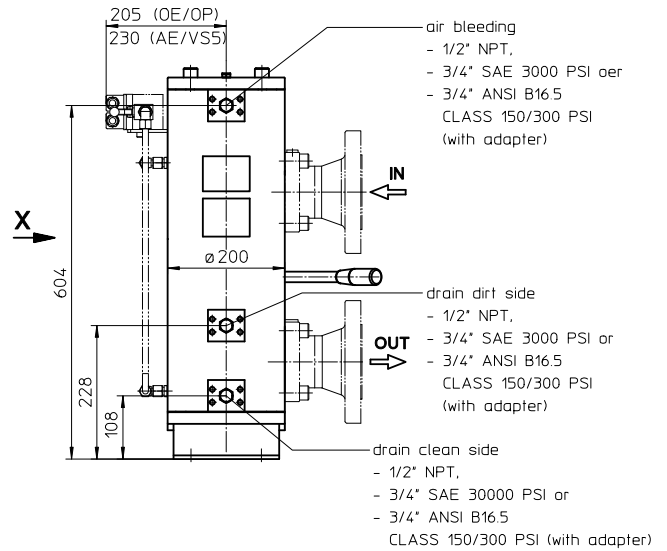
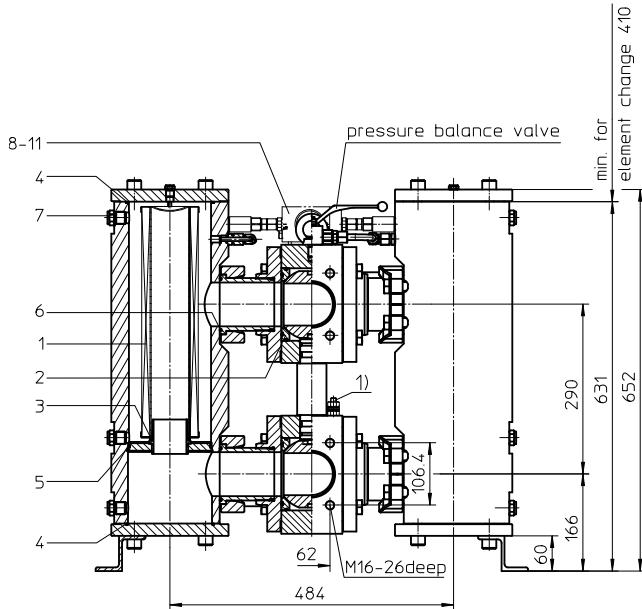

Position I: Filter 1 in operation
Position II: Filter 2 in operation

view "X"
with indicator OE/OP

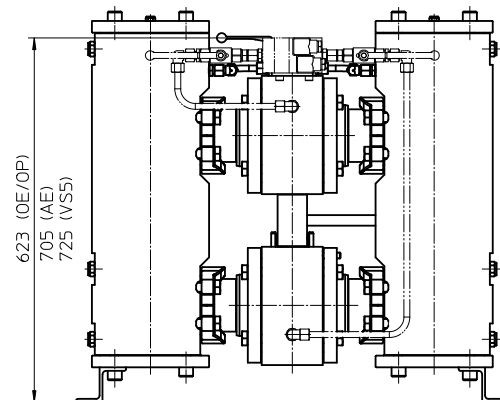

- 1) Connection for the potential equalization, only for application in the explosive area.
- Switch lever standard in the front.
- 2) On request
The switch lever can be moved to backside of the changeover valve, opposite to the inlet and outlet.
Please specify this configuration on the order.

Weight: approx. 250 kg

Dimensions: mm

Designs and performance values are subject to change.

Pressure Filter, changeover

Series EDA 633

NPS 3" CLASS 150-300 PSI

Description:

Stainless steel-pressure filter series EDA 633 have a working pressure up to 40 bar. Pressure peaks can be absorbed with a sufficient safety margin.

A changeover ball valve between the two filter housings makes it possible to switch from the dirty filter side to the clean filter side without interrupting operation.

The filter element consists of star-shaped, pleated filter material which is supported on the inside by a perforated core tube and is bonded to the end caps with a high-quality adhesive. The flow direction is from outside to inside.

For cleaning the stainless steel mesh element (see special leaflets 21070-4 and 39448-4) or changing the filter element, remove the cover and take out the element. The mesh elements are not guaranteed to maintain 100% performance after cleaning.

For filtration finer than 40 µm use disposable elements made of microglass. Filter elements as fine as 5 µm(c) are available; finer filter elements are available upon request.

Eaton filter elements are known for a high intrinsic stability and an excellent filtration capability, a high dirt-retaining capacity and a long service life.

Eaton filter elements are suitable for all petroleum based fluids, HW-emulsions, most synthetic hydraulic fluids and lubrication oils.

Ship classifications available upon request.

Type index:

Complete filter: (ordering example)

EDA. 633. 10VG. 30. E. P. VA. FA1. A. VA. IS21.

1	2	3	4	5	6	7	8	9	10	11
---	---	---	---	---	---	---	---	---	----	----

KH. OE

12	13
----	----

1 series:

EDA = stainless steel-pressure filter changeover, according to ASME-code

2 nominal size: 633

3 filter material:

80G, 40G, 25G, 10G stainless steel wire mesh
25VG, 16VG, 10VG, 6VG, 3VG microglass
25API, 10API microglass according to API

4 filter element collapse rating:

30 = Δp 30 bar

5 filter element design:

E = single-end open
S = with by-pass valve Δp 2,0 bar
S1 = with by-pass valve Δp 3,5 bar

6 sealing material:

P = Nitrile (NBR)
V = Viton (FPM)

7 filter element specification:

- = standard
VA = stainless steel

8 process connection:

FS = flange SAE 3000 PSI
FA1 = flange ANSI CLASS 300 PSI, sealing surface Rz = 160 µm (not finer than 40 µm)
FA2 = flange ANSI CLASS 300 PSI, sealing surface Rz = 16 µm
FA11 = flange ANSI CLASS 150 PSI, sealing surface Rz = 160 µm (not finer than 40 µm)
FA12 = flange ANSI CLASS 150 PSI, sealing surface Rz = 16 µm

9 process connection size:

A = 3"

10 filter housing specification:

VA = stainless steel, see sheet-no. 67617

11 specification pressure vessel:

IS21 = ASME VIII Div.1 with U-stamp, see sheet-no. 43415
IS23 = ASME VIII Div.1 without U-stamp, see sheet-no. 55218

12 shut-off :

- = without
KH = with shut-off ball valve

13 clogging indicator or clogging sensor:

- = without
AE = visual-electric, see sheet-no. 1609
OP = visual, see sheet-no. 1614
OE = visual-electric, see sheet-no. 1614
VS5 = electronic, see sheet-no. 1641

To add an indicator/sensor to your filter, use the corresponding indicator data sheet to find the indicator details and add them to the filter assembly model code.

Filter element: (ordering example)

01NL. 630. 10VG. 30. E. P. VA

1	2	3	4	5	6	7
---	---	---	---	---	---	---

1 series:

01NL = standard filter element according to DIN 24550, T3

2 nominal size: 630

3 - 7 see type index-complete filter

Accessories:

- SAE-counter flanges, see sheet-no. 1652
- drain- and bleeder connection, see sheet-no. 1659
- adapter for ANSI-connection B16.5 CLASS 150/300 PSI, see sheet-no. 1658

Technical data:

operating temperature:	-10°C to +100°C
operating medium:	mineral oil, other media on request
max. operating pressure (pressure vessel):	40 bar
test pressure acc. to ASME VIII Div. 1:	1,3 x operating pressure = 52 bar
test pressure acc. to API 614, Chapter 1:	1,5 x operating pressure = 60 bar
connection system:	SAE-flange 3000 PSI or ANSI-flange B16.5 CLASS 150/300 PSI
housing material:	stainless steel, see sheet-no. 67617
sealing material:	Nitrile (NBR) or Viton (FPM), other materials on request
installation position:	vertical
bleeder connection:	NPT ½" or SAE ¾" 3000 PSI
drain connection dirt side:	NPT ½" or SAE ¾" 3000 PSI
drain connection clean side:	NPT ½" or SAE ¾" 3000 PSI
volume tank:	2x 8,3 l
operating pressure adapter flanges:	according to B16.5 CLASS 150 PSI (max. 16 bar) according to B16.5 CLASS 300 PSI (max. 40 bar)

Classified under the Pressure Equipment Directive 2014/68/EU for mineral oil (fluid group 2), Article 4, Para. 3. Classified under ATEX Directive 2014/34/EU according to specific application (see questionnaire sheet-no. 34279-4)

Pressure drop flow curves:

Filter calculation/sizing

The pressure drop of the assembly at a given flow rate Q is the sum of the housing Δp and the element Δp and is calculated as follows:

$$\Delta p_{assembly} = \Delta p_{housing} + \Delta p_{element}$$

$$\Delta p_{housing} = (\text{see } \Delta p = f(Q) - \text{characteristics})$$

$$\Delta p_{Element} (mbar) = Q \left(\frac{l}{min} \right) \times \frac{MSK (mbar)}{10 \left(\frac{l}{min} \right)} \times v \left(\frac{mm^2}{s} \right) \times \frac{\rho (kg)}{0,876 (dm^3)}$$

For ease of calculation our Filter Selection tool is available online at www.eatonpowersource.com/calculators/filtration/

Material gradient coefficients (MSK) for filter elements

The material gradient coefficients in mbar/(l/min) apply to mineral oil (HLP) with a density of 0,876 kg/dm³ and a kinematic viscosity of 30 mm²/s (139 SUS). The pressure drop changes proportionally to the change in kinematic viscosity and density.

EDA	VG					G				API	
	3VG	6VG	10VG	16VG	25VG	10G	25G	40G	80G	10 API	25 API
633	0,436	0,303	0,194	0,169	0,115	0,1911	0,1417	0,1322	0,0906	0,099	0,045

$\Delta p=f(Q)$ – characteristic according ISO 3968

The pressure drop characteristics apply to mineral oil (HLP) with a density of 0,876 kg/dm³. The pressure drop changes proportionally to the density.

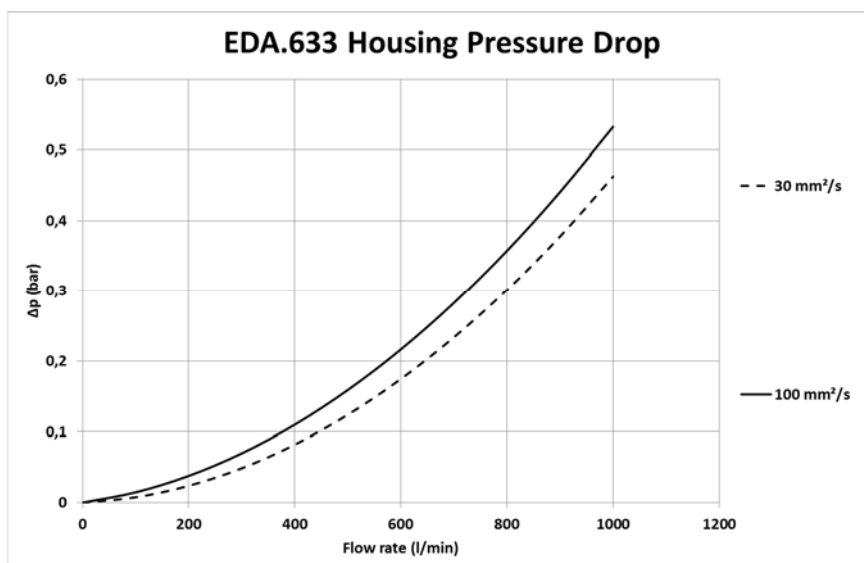

Symbols:

without indicator

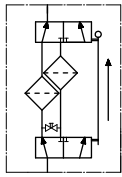

with shut-off ball valve

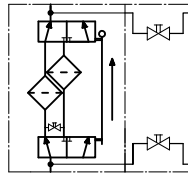

with electric indicator
AE 30 and AE 40

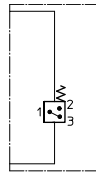

with visual-electric indicator
AE 50 and AE 62

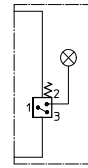

with visual-electric indicator
AE 70 and AE 80

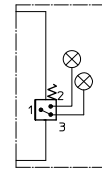

with visual indicator
OP

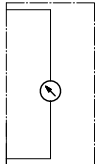

with visual-electric indicator
OE

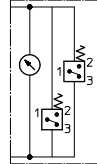

with electronic sensor
VS5

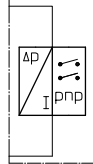

Spare parts:

item	qty.	designation	dimension	article-no.	
1	2	filter element	01NL.630...		
2	4	gasket kit of changeover	DN80 (3")	350658 (NBR)	350659 (FPM)
3	2	O-ring	60 x 3,5	304377 (NBR)	304398 (FPM)
4	4	O-ring	145,72 x 2,62	350981 (NBR)	350150 (FPM)
5	2	O-ring	136,12 x 3,53	320162 (NBR)	320163 (FPM)
6	4	O-ring	85 x 3,5	311309 (NBR)	317033 (FPM)
7	6	screw plug	NPT 1/2"	307766	
8	1	clogging indicator, visual-electric	OE	see sheet-no. 1614	
9	1	clogging indicator, visual	OP	see sheet-no. 1614	
10	1	clogging indicator, visual-electric	AE	see sheet-no. 1609	
11	1	clogging sensor, electronic	VS5	see sheet-no. 1641	

Test methods:

Filter elements are tested according to the following ISO standards:

ISO 2941	Verification of collapse/burst resistance
ISO 2942	Verification of fabrication integrity
ISO 2943	Verification of material compatibility with fluids
ISO 3723	Method for end load test
ISO 3724	Verification of flow fatigue characteristics
ISO 3968	Evaluation of pressure drop versus flow characteristics
ISO 16889	Multi-pass method for evaluating filtration performance

North America

44 Apple Street
Tinton Falls, NJ 07724
Toll Free: 800 656-3344
(North America only)
Tel: +1 732 212-4700

Europe/Africa/Middle East

Auf der Heide 2
53947 Nettersheim, Germany
Tel: +49 2486 809-0

Friedensstraße 41
68804 Altlußheim, Germany
Tel: +49 6205 2094-0

An den Nahewiesen 24
55450 Langenlonsheim, Germany
Tel: +49 6704 204-0

China

No. 3, Lane 280,
Linhong Road
Changning District, 200335
Shanghai, P.R. China
Tel: +86 21 5200-0099

Singapore

100G Pasir Panjang Road #07-08
Singapur 118523
Tel: +65 6825-1668

Brazil

Rua Clark, 2061 - Macuco
13279-400 - Valinhos, Brazil
Tel: +55 11 3616-8400

For more information, please
email us at filtration@eaton.com
or visit www.eaton.com/filtration

© 2019 Eaton. All rights reserved. All trademarks and registered trademarks are the property of their respective owners. All information and recommendations appearing in this brochure concerning the use of products described herein are based on tests believed to be reliable. However, it is the user's responsibility to determine the suitability for his own use of such products. Since the actual use by others is beyond our control, no guarantee, expressed or implied, is made by Eaton as to the effects of such use or the results to be obtained. Eaton assumes no liability arising out of the use by others of such products. Nor is the information herein to be construed as absolutely complete, since additional information may be necessary or desirable when particular or exceptional conditions or circumstances exist or because of applicable laws or government regulations.