

Series DU 631 DN65 PN63

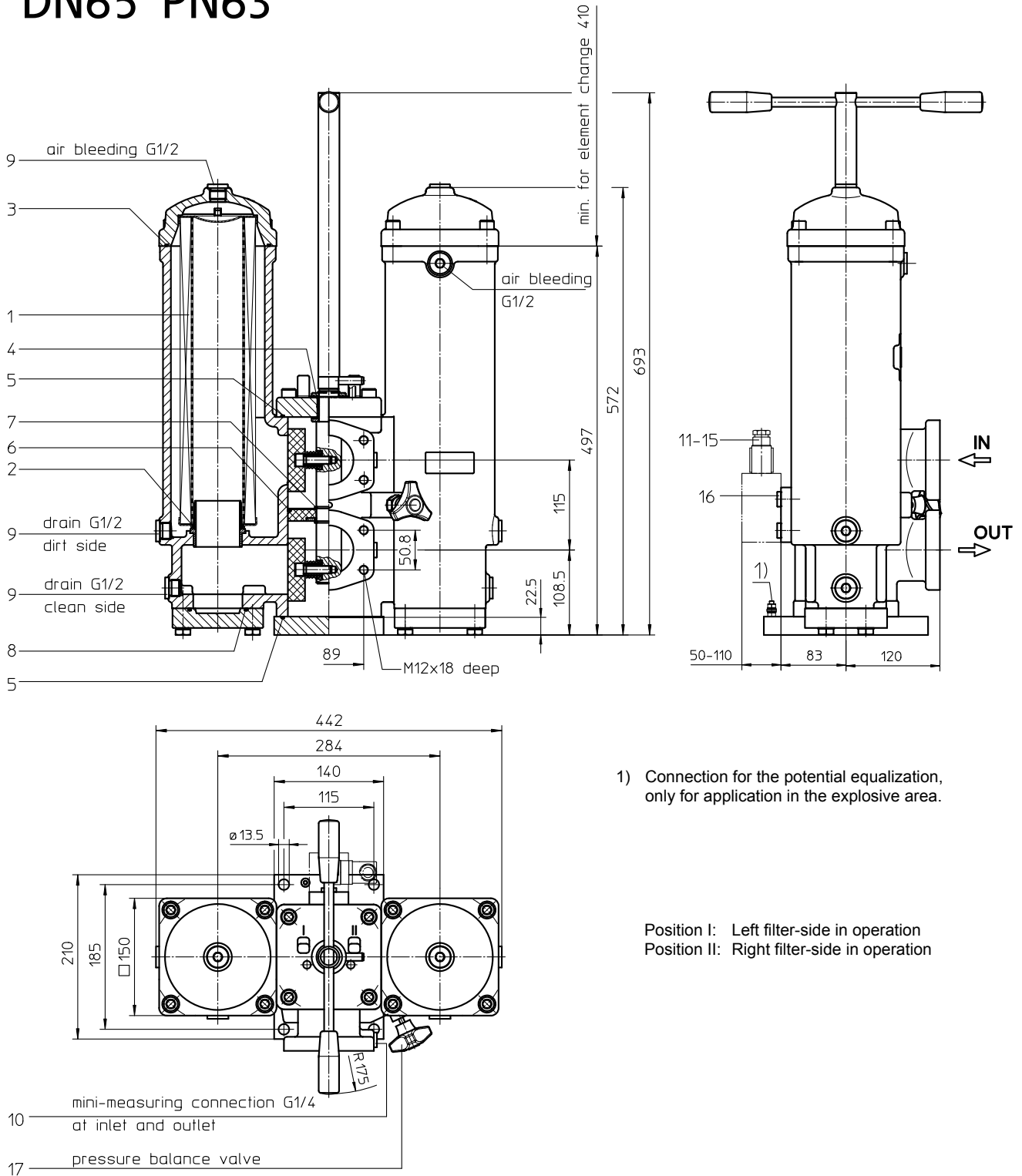

weight: approx. 76 kg

Dimensions: mm

Designs and performance values are subject to change.

Pressure Filter, change over Series DU 631 DN65 PN63

Description:

Pressure filter change over series DU 631 have a working pressure up to 63 bar. Pressure peaks can be absorbed with a sufficient safety margin.

A three-way-change-over valve which is integrated in the middle of the housing makes it possible to switch from the dirty filter-side to the clean filter-side without interrupting operation. These filters can be installed as suction filters.

The filter element consists of star-shaped, pleated filter material, which is supported on the inside by a perforated core tube and is bonded to the end caps with a high-quality adhesive. The flow direction is from outside to inside.

For cleaning the stainless steel mesh element (see special leaflets 21070-4 and 39448-4) or changing the filter element, remove the cover and take out the element. The mesh elements are not guaranteed to maintain 100% performance after cleaning.

For filtration finer than 40 µm, use the disposable elements made of microglass. Filter elements as fine as 5 µm(c) are available; finer filter elements are available upon request.

Eaton filter elements are known for a high intrinsic stability and an excellent filtration capability, a high dirt-retaining capacity and a long service life.

Eaton filter can be used for petroleum-based fluids, HW emulsions, water glycols, most synthetic fluids and lubrication fluids. Consult factory for specific fluid applications.

Ship classifications available upon request.

Type index:

Complete filter: (ordering example)

DU. 631. 10VG. 30. E. P. -. FS. 9. -. IS63. -. AE

1	2	3	4	5	6	7	8	9	10	11	12	13
---	---	---	---	---	---	---	---	---	----	----	----	----

- 1 | **series:**
DU = pressure filter, changeover
- 2 | **nominal size:** 631
- 3 | **filter-material:**
80G, 40G, 25G stainless steel wire mesh
25VG, 16VG, 10VG, 6VG, 3VG microglass
25API, 10API microglass according to API
10P paper
- 4 | **filter element collapse rating:**
30 = Δp 30 bar
- 5 | **filter element design:**
E = single end open
S = with bypass valve Δp 2,0 bar
S1 = with bypass valve Δp 3,5 bar
- 6 | **sealing material:**
P = Nitrile (NBR)
V = Viton (FPM)
- 7 | **filter element specification:**
- = standard
VA = stainless steel
IS06 = for HFC application, see sheet-no. 31601
IS07 = for oil/amonia mixtures (NH₃), see sheet-no. 31602
- 8 | **process connection:**
FS = SAE-flange connection 3000 PSI
- 9 | **process connection size:**
9 = 2 ½"
- 10 | **filter housing specification:**
- = standard
IS12 = internal parts of change over armature stainless steel, see sheet-no. 41028
- 11 | **pressure vessel specification:**
IS63 = for operating pressure to 63 bar, see sheet-no. 68796
- 12 | **internal valve:**
- = without
- 13 | **clogging indicator or clogging sensor:**
- = without
AOR = visual, see sheet-no.1606
AOC = visual, see sheet-no.1606
AE = visual-electric, see sheet-no.1609
OP = visual, see sheet-no.1628
OE = visual-electric, see sheet-no.1628
VS5 = electronic, see sheet-no.1641

To add an indicator/sensor to your filter, use the corresponding indicator data sheet to find the indicator details and add them to the filter assembly model code.

Filter element: (ordering example)

01NL. 630. 10VG. 30. E. P. -

1	2	3	4	5	6	7
---	---	---	---	---	---	---

- 1 | **series:**
01NL. = standard filter element according to DIN 24550, T3
- 2 | **nominal size:** 630
- 3 | - 7 | see type index complete filter

Accessories:

- gauge port and bleeder connection, see sheet-no. 1650
- drain- and bleeder connection, see sheet-no. 1659
- SAE-counter flanges, see sheet-no. 1652
- shut-off valve, see sheet-no. 1655

Technical data:

design temperature:	-10 °C to +100 °C
operating temperature:	-10 °C to +80 °C
operating medium:	mineral oil, other media on request
max. operating pressure:	63 bar
test pressure:	126 bar
process connection:	SAE-flange connection 3000 PSI
housing material:	EN-GJS-400-18-LT
sealing material:	Nitrile (NBR) or Viton (FPM), other materials on request
installation position:	vertical
measuring connections:	G ¼
drain- and bleeder connections:	G ½
volume tank:	2x 5,7 l

Classified under the Pressure Equipment Directive 2014/68/EU for mineral oil (fluid group 2), Article 4, Para. 3.
 Classified under ATEX Directive 2014/34/EU according to specific application (see questionnaire sheet-no. 34279-4).

Pressure drop flow curves:

Filter calculation/sizing

The pressure drop of the assembly at a given flow rate Q is the sum of the housing Δp and the element Δp and is calculated as follows:

$$\Delta p_{assembly} = \Delta p_{housing} + \Delta p_{element}$$

$$\Delta p_{housing} = (\text{see } \Delta p = f(Q) \text{ - characteristics})$$

$$\Delta p_{Element} (mbar) = Q \left(\frac{l}{min} \right) \times \frac{MSK}{10} \left(\frac{mbar}{l/min} \right) \times v \left(\frac{mm^2}{s} \right) \times \frac{p}{0,876} \left(\frac{kg}{dm^3} \right)$$

For ease of calculation our Filter Selection tool is available online at
www.eatonpowersource.com/calculators/filtration/

Material gradient coefficients (MSK) for filter elements

The material gradient coefficients in psi/gpm apply to mineral oil (HLP) with a density of 0,876 kg/dm³ and a kinematic viscosity of 30 mm²/s (139 SUS). The pressure drop changes proportionally to the change in kinematic viscosity and density.

DU	VG					G			P	API	
	3VG	6VG	10VG	16VG	25VG	25G	40G	80G	10P	10API	25API
631	0,436	0,303	0,194	0,169	0,115	0,1417	0,1322	0,0906	0,092	0,099	0,045

$\Delta p = f(Q)$ – characteristics according to ISO 3968

The pressure drop characteristics apply to mineral oil (HLP) with a density of 0,876 kg/dm³. The pressure drop changes proportionally to the density.

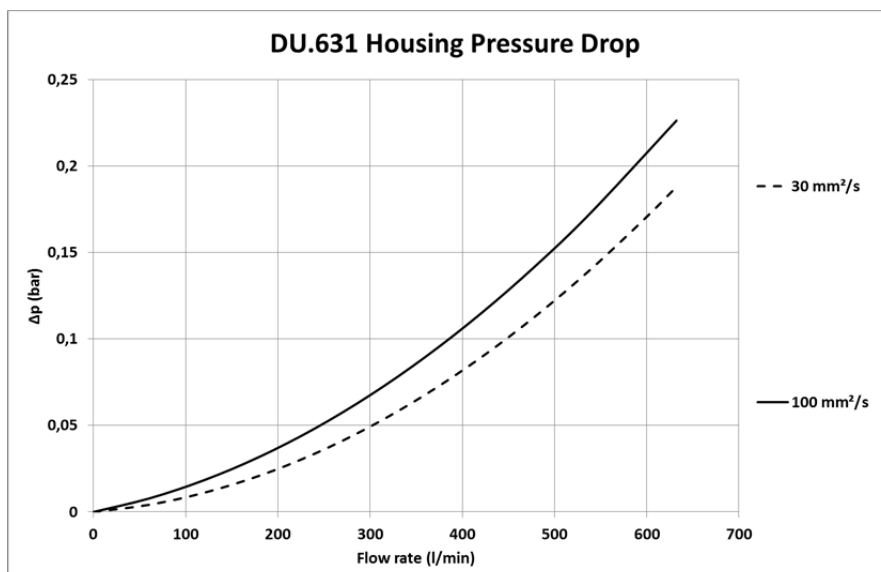

Symbols:

without indicator

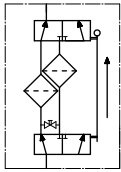

with electric indicator
AE 30 and AE 40

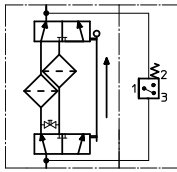

with visual-electric indicator
AE 50 and AE 62

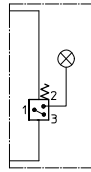

with visual-electric indicator
AE 70 and AE 80

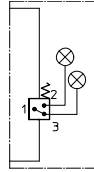

with visual indicator
AOR/AOC/OP

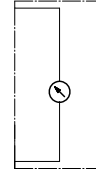

with visual-electric indicator
OE

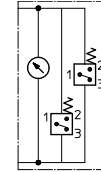

with electronic sensor
VS5

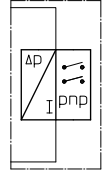

Spare parts:

item	qty.	designation	dimension	article-no.	
1	2	filter element	01NL.630...		
2	2	O-ring	60 x 3,5	304377 (NBR)	304398 (FPM)
3	2	O-ring	125 x 3	306025 (NBR)	307358 (FPM)
4	1	O-ring	24 x 3	303038 (NBR)	304397 (FPM)
5	2	O-ring	115 x 3	303963 (NBR)	307762 (FPM)
6	1	O-ring	96 x 4	305190 (NBR)	308148 (FPM)
7	1	O-ring	32 x 2,5	306843 (NBR)	308268 (FPM)
8	2	O-ring	69,45 x 3,53	305868 (NBR)	307357 (FPM)
9	8	screw plug	G 1/2	304678	
10	2	screw plug	G 1/4	305003	
11	1	clogging indicator, visual	AOR or AOC	see sheet-no. 1606	
12	1	clogging indicator, visual r, optisch	OP	see sheet-no. 1628	
13	1	clogging indicator, visual-electric	OE	see sheet-no. 1628	
14	1	clogging indicator, visual-electric	AE	see sheet-no. 1609	
15	1	clogging sensor, electronic	VS5	see sheet-no. 1641	
16	2	screw plug	G 1/4	305003	
17	1	pressure balance valve	DN10	305000	

item 16 execution only without clogging indicator or clogging sensor

Test methods:

Filter elements are tested according to the following ISO standards:

ISO 2941	Verification of collapse/burst resistance
ISO 2942	Verification of fabrication integrity
ISO 2943	Verification of material compatibility with fluids
ISO 3723	Method for end load test
ISO 3724	Verification of flow fatigue characteristics
ISO 3968	Evaluation of pressure drop versus flow characteristics
ISO 16889	Multi-pass method for evaluating filtration performance

North America

44 Apple Street
Tinton Falls, NJ 07724
Toll Free: 800 656-3344
(North America only)
Tel: +1 732 212-4700

Europe/Africa/Middle East

Auf der Heide 2
53947 Nettersheim, Germany
Tel: +49 2486 809-0

Friedensstraße 41
68804 Altlußheim, Germany
Tel: +49 6205 2094-0

An den Nahewiesen 24
55450 Langenlonsheim, Germany
Tel: +49 6704 204-0

China

No. 3, Lane 280,
Linhong Road
Changning District, 200335
Shanghai, P.R. China
Tel: +86 21 5200-0099

Singapore

4 Loyang Lane #04-01/02
Singapore 508914
Tel: +65 6825-1668

Brazil

Rua Clark, 2061 - Macuco
13279-400 - Valinhos, Brazil
Tel: +55 11 3616-8400

For more information, please

email us at filtration@eaton.com

or visit www.eaton.com/filtration

© 2015 Eaton. All rights reserved. All trademarks and registered trademarks are the property of their respective owners. All information and recommendations appearing in this brochure concerning the use of products described herein are based on tests believed to be reliable. However, it is the user's responsibility to determine the suitability for his own use of such products. Since the actual use by others is beyond our control, no guarantee, expressed or implied, is made by Eaton as to the effects of such use or the results to be obtained. Eaton assumes no liability arising out of the use by others of such products. Nor is the information herein to be construed as absolutely complete, since additional information may be necessary or desirable when particular or exceptional conditions or circumstances exist or because of applicable laws or government regulations.