



Operating Manual

Design changes may be made without notice. All rights reserved.

The content of this manual has been reviewed for correctness however it is the user's responsibility to confirm all instructions and to operate the equipment in a safe and correct manner.



Powering Business Worldwide

Standard and Special Models

Index:

Cover Sheet: Pressure Equipment Specification

The coversheet describes the operating conditions, markings and equipment as well as the equipment classification. The coversheet is part of the equipment.

1.0 General Instruction

- 1.1 Residual hazards
- 1.2 Warning notices
- 1.3 Housing life cycles

2.0 Specification, Functional Principle, Typical Designs

- 2.1 Operating principle
- 2.2 Typical Designs

3.0 Storing and Transport, Installation and Adjustment

- 3.1 Storing
- 3.2 Transport
- 3.3 Installation and adjustment

4.0 Start up

- 4.1 Cover Lid-opening
 - 4.1.1 Bolted joint design
 - 4.1.2 Centre bolt closure (T-bolt closure)
 - 4.1.3 QIC-LOCK spindle closure
- 4.2 Filter Bag Insertion
- 4.3 Cover Lid-closing
- 4.4 Start up

5.0 Use, handling and maintenance

- 5.1 Use and handling
- 5.2 Maintenance of the filter housing
- 5.3 Recurring inspections

6.0 Maintenance of the spring-assisted lid lift

- 6.1 Maintenance
- 6.2. Adjustment
- 6.3 Cautions

7.0 Technical Data

8.0 Design with heating jacket

9.0 Information about bag filters with internal coating

10.0 General operating instructions

11.0 Use with Strainer Baskets

1.0 General Instructions



The operating manual is part of the filter equipment and instructions contained herein must be followed.

Eaton bag filters are carefully constructed and manufactured using the stringent quality controls of our ISO 9001:2015 certification.

However, the filter may become a hazard if not used or installed properly.

The operator must evaluate the impact of filter failure on the environment within the framework of his own safety guidelines and decide whether additional measures are necessary to ensure operator and facility safety.

The filter must be operated in a safe manner.

All normal and customary rules and regulations for safe operation and avoidance of injury must be followed.

For the operation of the filter vessel the existing national regulations need to be followed. Additionally, we would draw your attention to the following CE Directives:

89/391/EEC: on the introduction of measures to encourage improvements in the safety and health of workers at work

89/655/EEC: (changed 95/63/EG): on the Minimum Safety and Health Requirements for the Use of Work Equipment.

No work on a filter should be performed without first shutting it down completely and releasing the pressure.

Eaton filter housings are to be serviced by authorized personnel only.



The operating manual is part of the pressure equipment (filter) and has to be kept for the equipment life cycle. It must be available at all times for the operator and in case of loss or damage immediately replaced. Operating manuals are available from the manufacturer or its authorized dealer.

1.1 Residual hazards



Reading and paying attention to operating instructions is essential.

1.1.1 Residual risks due to pressure and temperature

If the maximum pressure is higher than atmospheric pressure, then the vessel must be equipped with an adequate and accurate pressure-measuring device, such as a pressure gauge. Should the temperature of the medium be a safety hazard (e.g. by exceeding the boiling point), a temperature-measuring device has to be installed.

Depending on the operating conditions, the surface of the filter vessel may become very hot.

Adequate safety measures must be taken by the customer when operating the filter to protect against the danger of getting burned.

Appropriate precautions can be: isolation, protection against contact and access restrictions

1.1.2 Residual hazard due to pressure:

Exceeding the rated operating pressure must be prevented by means of suitable devices or equipment located either at the pressurized equipment or at the assembly (if the pressurized equipment cannot be cut off).

Pressures briefly exceeding the rated pressure are permissible, but only if they are less than 10% greater than the maximum rated pressure.

The protective devices or equipment must properly and only fulfill their safety functions.

Safety devices and equipment must operate in a manner that is foolproof, reliable and suitable for the intended mode of operation.

1.1.3 Residual hazard due to corrosion or chemical effects:

In general, filters are used to filter many different types of liquids. The user must take into consideration how the filtered liquid will affect filter housing and accessories. These effects may include corrosion, dissolving or weakening of the filter housing. This applies to all material in contact with the liquid being filtered, especially parts under pressure, such as gaskets, seals, shaft bushings and bolted connections. The user must select an appropriate housing material for the intended use and confirm its suitability.

Regular inspections must be performed while the equipment is in service. It is recommended to record the inspections and to keep the record.

1.1.4 Residual hazards due to external loads:

Possible external loads from—wind, snow, earthquake or traffic, and the impact on nozzles, legs and supports have to be identified and an assessment made on consequences to the pressure equipment. If not specifically mentioned the equipment is **not** designed for, nor should it be subjected to these types of load.

1.1.5 Residual hazard due to filling or emptying:

The user must take suitable measures to ensure that liquids under pressure cannot escape in an uncontrolled manner from open degassing (exhaust) lines, for example, whilst the pressurized equipment (filter) is being filled. This applies to both draining and emptying the equipment.

The closure elements must be fashioned such that secure operation is possible.

All connections to the filter must be executed professionally and in accordance with the standard piping practices. When choosing O-ring process media leakage and operational conditions must be considered. A permanent connection is preferred in all cases. Should flexible hoses be used it is important to consider all circumstances that may have an effect on sealing, process media leakage and reliability as well as other safety and relevant issues. This is also relevant in reference to connections that have to do with de-gassing or venting, such as pressure warning systems.

If emptying (also faulty emptying) can cause positive operating pressure, then this risk needs to be secured through a bursting disc or connected emptying and venting equipment.

1.1.6 Residual hazard due to wear:

Under certain conditions, failure of material due to known chemical effects (corrosion) or mechanical effects (wear) must be taken into consideration. This is often dealt with by using increased wall thicknesses, casings or coatings.

For operational continuity, the user must employ suitable means to ensure that planned, periodic inspections are performed. Any damage must be immediately corrected.

1.1.7 Residual hazard due to external fire:

External fire can damage the equipment and cause safety issues. The user must evaluate the potential for this type of damage and take suitable precautions to limit or prevent it.

1.1.8 Residual hazards due to decomposition of unstable fluids

An assessment of the risk of damage to the equipment from decomposition of unstable fluids has to be made and protected against.

1.1.9 Residual hazards due to the character of operating and during maintenance

Filtration of flammable fluids could be dangerous during filter element change out.

The filter element itself may cause hazards during change out and use.

Textile filter media tends to have an electrostatic charge. This has to be observed if explosive atmospheres are present in the filter or the area around the filter (filtration of flammable solvents).

Also possible are reactions between filter media and filtrate or the trapped solids (auto ignition).

The filter element normally contains product residue. (fluid residue or wetted cake).

If the fluid is dangerous (caustic, corrosive, carcinogenic, mutagenic, toxic, flammable, etc.)

suitable protection for operators must be provided.

Examples as described above have to be assessed by the user and prevented with appropriate procedures.

Counter measures may include: appropriate earthing, venting, flushing with harmless fluids, drying, inert gas flushing, minimizing of residual fluid, etc.

1.2 Warning notices

The following warnings have been placed on the equipment. Please see where crossed:

None

Warning: Do not open under pressure

Warning: Spring under tension

1.3 Housing life cycle

There is no general lifetime for the equipment. In regards to the design and character of the construction, please check the correct cover page.

Standard housings are designed for 1000 operational start-up and shut offs. Pressure changes between ambient pressure and the design pressure.

Pressure changes within 10% of the design pressure are permanently allowed.

Pressure changes other than these are noted in the equipment's coversheet or in the construction drawing.

Regular checks of the equipment are advised, according to local regulations of pressure vessels.

Check periods may be regulated by national regulations, work conditions or laws. The operator is obliged to make sure that these regulations are known and observed.

See also: Maintenance of the Bag Filter

2.0 Specification, functional principle, typical designs

2.1 Functional principle

The main element of the bag filter systems is the filter bag.

The filter bag is typically made of textiles like needle-felt, melt-blown or woven materials of mono- or multi-filament fibers. Metal strainer baskets may also be used. The filter bag is inserted into a restrainer basket. This basket supports the bag and holds up to the pressures applied with increasing differential pressures. The restrainer basket is seated in position inside the housing between the incoming unfiltered liquid (inlet side) and the clean filtrate (outlet side). The filter bag is held in place by a bag hold-down device.

The dirty liquid flows through the filter material where dirt is trapped. The fact that particles are collected and retained inside the filter bag is one of the significant characteristics of the bag filter system. These systems are simple, secure and operator-friendly.

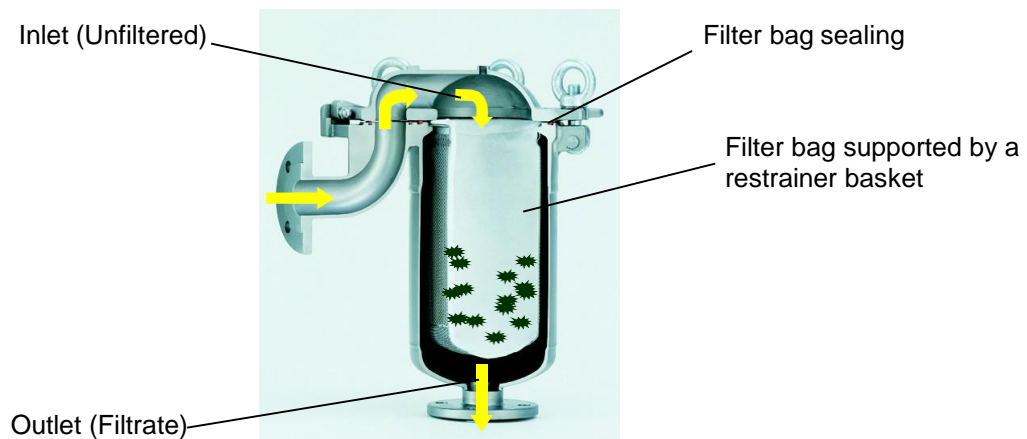

Bag filter housings may contain between 1 and 24 filter bags, depending on type and design. The different designs are adapted to individual applications and may vary greatly. The designs take into consideration operating conditions, materials of construction, connection types and positions, as well as surface finish and operating parameters.

2.2 Typical Design

MAXILINE VMBF

MAXILINE MBF



FLOWLINE

SIDELINE

TOPLINE

3.0 Storing and transport, installation and adjustment

3.1 Storing

Equipment must be stored in a secure location.

Equipment should not be stored in a corrosive environment.

Necessary steps to ensure a clean housing interior should be taken. Openings at the connections should be plugged, if this is not already done by the manufacturer. If extreme cleanliness of the housing is necessary, a safety atmosphere with inert gas (nitrogen) should be used.

3.2 Transport

Appropriate means are to be used for any transport of equipment. If a filter needs to be lifted with a carrying belt (without original packaging) adequate lifting points need to be chosen. If extra carrying elements (ring nuts or carrying devices) are available, these must be used. Security precautions should be taken to protect people and equipment.

e.g. adequate security distances
 no person or equipment below suspended equipment
 adequate secure lifting attachments

3.3 Installation and adjustment



Important Notice:

Before installing the bag filter check that the operating parameters have been met. The specifications on the bag filter label must be checked against operating conditions. Do not exceed the listed operating pressure and temperature. Excess of operating conditions are to be avoided by the operator through adequate equipment (installation of pressure relieve valve).

Also make sure that the materials—which are going to come into contact with the product—are chemically suitable. This applies to the materials used for the filter housing, the gaskets and the filter media.



Because of the unlimited number of operating conditions only general guidance can be given. The responsibility for the choice of materials for specific applications lies exclusively with the operator. Eaton is not responsible for and provides no guarantee for the suitability of materials.

Installation instructions:

Carefully unpack and check for damage.

Remove all enclosed operating instructions, data sheets, illustrations etc., read carefully and set aside for future use. Make sure all accessories are enclosed. Remove the plastic protective caps from the flanges.

Here is a diagram of a typical filter installation:

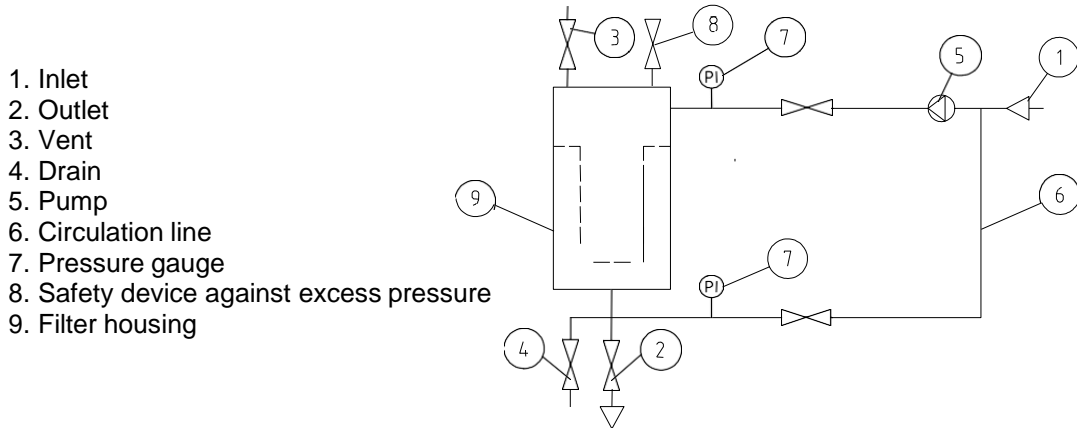

The filter housing shown above is equipped with shut-off devices for discharge and venting. Pressure gauges for measuring the differential pressure are installed in the inlet and outlet connections.

There should be a re-circulation line for cleaning the system if this is feasible and suitable.

Please note:

The parts described above are not included with the equipment.

When installing take care not to reverse the inlet and outlet.

The direction of flow is not always marked, but can be determined by noting that the inlet lies above the outlet. The outlet is usually at the bottom.

The inlet allows the liquid to flow into the filter bag so that the direction of flow is from the inside to the outside.

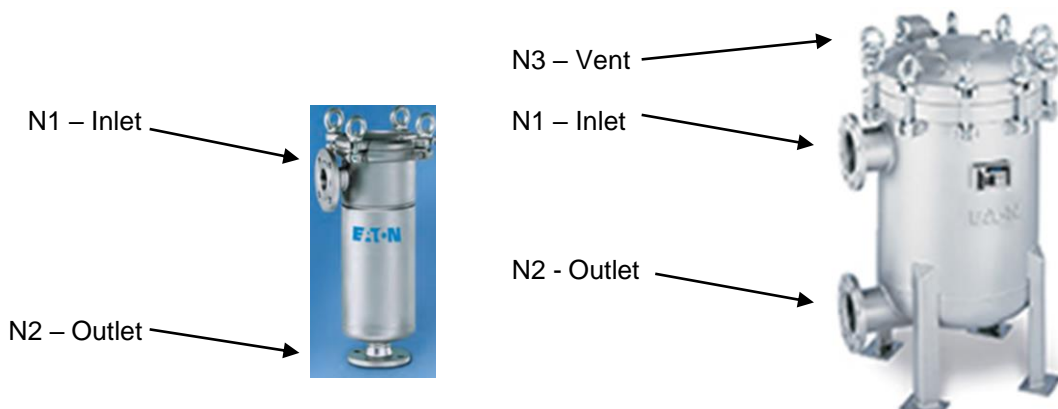

General regulation:

Filter bags are used with flow from inside to outside.

Mesh strainers are used with flow from inside to outside.

Any deviations are explained separately under point 4 operating system.

Observe national and local regulations when setting and running the pressure vessel, and also:

Establish security areas and distances where necessary for the protection of employees and others. Ensure an easy access and secure work area for the housing.

Ensure secure installation (bolting) to prevent shifting or other movement by external forces; such as the housings own weight, pressure or the fluids entering the housing.

Important Notice:

Pipe connections must be made so that they are stress free.

Additional weight on the connections is not allowed unless explicitly stated.

It is expected that the installation of the filter housing into the piping system, including additional accessories, is executed professionally and according to national and local codes and regulations.



4.0 Start up

Notice:

Normally after the installation of the filter housing, a pressure seal test as well as a cleaning of the housing is done.

Cleaning of:

a. Particles inside the housing

Filter housings are usually blasted with glass beads and cleaned afterwards. It is unavoidable that some beads may remain in the housing. It is suggested to clean the filter housing with a process suitable cleaning liquid. (see general operations suggestions).

In certain cases filter housings are treated with pickling acid and cleaned with demineralized water.

b. Anti-corrosives

In some cases parts may be protected with anti-corrosives. For example, carbon steel filter housings with anti-rust protection (oiled, waxed or similar). This protection is to be removed (through steam-cleaning or solvents) should this material be likely to cause harm to the process media or related equipment.

c. Lubricants

Depending on the design of the filter certain movable parts may be factory-lubricated: the QIC-LOCK quick-closure mechanism. The lubrication is based upon mineral oil, lithium-soap and additives. The lubricant is not rated as dangerous. Should a reaction with the production liquid be seen as a possible hazard, then these parts need to be cleaned carefully before start-up. It is then recommended to replace the lubricant with an alternative, more suitable lubricant.

Pressure seal test

It is generally recommended to perform a pressure test after the installation of the filter housing. The choice of test media is to be based upon the following operating conditions. Opening and closing procedures of the filter housing are described below.

The recommended operating conditions may not be exceeded.

4.1 Cover lid - opening

4.1.1 Bolted joint design

This particular design is found in filter types: FLOWLINE-FBF, SIDELINE-SBF, TOPLINE-TBF, MAXILINE-MBF and MDE



To open the housing: first loosen the eye nuts on the top. The eye nuts can be loosened using a small bar. Where hexagon nuts are used the appropriate wrench should be used. If swing bolts are used the nuts should be loosened enough to allow for them to be swung clear of the cover.

Similar procedures are to be followed for segment clamp-screws.

If stud bolts are used the hexagon nuts must be removed completely.

The cover of the housing may now be taken off or hinged back against the end-stop.

Multi-bag filter housings, type MAXILINE have a spring-lift or davit mechanism to aid the opening of the cover. These mechanisms, where appropriate, are described on the following pages.

Notice that depending on the size of the filter housing the cover may have significant weight. Opening quickly can therefore cause great forces and significant damage can be caused by striking other objects. (A similar process is the rapid opening or closing of a door, which can cause personal injuries). Therefore the cover must be opened and closed slowly.

4.1.2 Centre bolt closure (T-bolt closure)

For example filter type

SIDELINE-TSBF
TOPLINE-TTBF

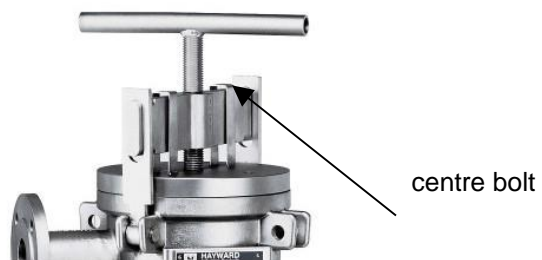

SIDELINE-TSBF and TOPLINE-TTBF filter housings with a centre bolt closure should only be opened and closed by hand.

Depending on style and design these filter housings may be equipped with an additional security device. This device is to be opened first to enable the main opening mechanism. In case of a quick-closure mechanism additional seal break devices are installed on the cover that ensure a slight lifting of the cover before full opening to break the seals in case the sealing surfaces are stuck together for some reason. The opening sequence is automatic and can only be manipulated through the removal (dismantling) of security devices. Their removal is not permitted in any circumstance. The proper function of all security devices is to be checked and maintained on a regular basis. The cover of the housing can now be opened and rested against the hinge-stop.

4.1.3 Design with QIC-LOCK spindle closure

MAXILINE VMBF and VMDE are example filter types with this design.



The QIC-LOCK mechanism is a two piece V-shaped clamp that can be opened and closed using a hand operated spindle mechanism. The V-shape closes over the housing and cover flange that seals with an O-ring. The V-clamp is then locked by closing a handle that closes a pressure relief device. This device needs to be opened first in order to operate the spindle.

In the case of a quick-closure mechanism, additional seal break devices are installed on the cover that enforce a slight lifting of the cover before full opening to break the seals in case the sealing surface are stuck together for some reason. The opening sequence is automatic and can only be changed through the removal (dismantling) of security devices. Their removal is not permitted in any circumstances. The correct operation of all security devices must be checked and maintained on a regular basis. The cover of the housing can now be opened and rested against the hinge-stop.

Multi-bag filter housings (MAXILINE series) are equipped with a spring-assisted mechanism, a davit, or a spring for lifting the cover. This mechanism will be explained below.

Notice that depending on the size of the filter housing the cover may have significant weight. Opening quickly can therefore cause great forces and significant damaged can be caused by striking other objects. A similar process is the rapid opening or closing of door, which can cause personal injuries. Therefore the cover must be opened and closed slowly.

4.2 Filter bag insertion

Previous special instructions for the preparation and installation of filter elements into the filter housing should be followed first. Filter housings are normally not shipped with filter bags installed. Without support, filter bags are not able to withstand the differential pressure that occurs during operation. This support is provided by the restrainer basket.

If not pre-installed, the restrainer baskets must be installed into the filter housing. Depending on the construction the basket may contain a bead that together with an extraction tool makes removal of the basket easier. The extraction tool is inserted into the basket with the flat end (round edges) first and then hooked under the bead to remove the basket. With the restrainer basket installed, the filter bag can now be inserted into the basket. Remove the filter bag label and retain for information for tracking and reordering.

The sealing ring of the filter bag must be positioned exactly on the edge of the restrainer basket to provide a good seal. The filter bag should be opened against the basket so that the bag is fully supported. Depending on the type of filter housing the filter bag is locked in position by using a bag-fixing ring (spring supported) or bayonet ring. The bayonet rings should be tightened down using the ring lock tool.



Bag-fixing rings for FLOWLINE and SIDELINE housings have a spring steel band for hold down. The pressure is provided by the cover of the filter housing. It is important that the pressure is applied onto the sealing ring of the filter bag; if it does not the bag-fixing ring may need to be adjusted.

MAXILINE MBF and VMBF multi-bag filter housings are equipped with bag-fixing rings that are locked by bayonets. A special tool is available to lock the ring. This tool is supplied with the filter housing.



Beware:

FLOWLINE bag filter housings (unlike other housings) are equipped with a profile gasket in the basket seating area. This gasket is made of elastomer (FPM). This gasket offers technical advantages but special care must be taken with its use.

Due to changing pressure, high differential pressure, pulsating pressure, chemical attack or high temperature the profile gasket may become damaged. As a result the basket may fall through to the bottom of the housing causing the filter to malfunction. Check to ensure the operating parameters of the application are compatible with this seal. If in doubt, contact Eaton for technical support.

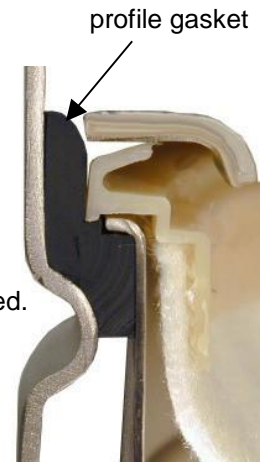

4.3 Cover lid - closing

Before closing the cover ensure that the sealing surfaces along with the gasket are clean and damage free. Make sure the gasket is sitting in its correct position. Replace gasket if faulty.



Remove and discard damaged gaskets!

To close the filters reverse the above steps.

Bag filter housings are usually equipped with one or on special designs with more than one O-ring. Depending on the application special housing designs may also be equipped with flat gaskets.

Less cover bolt torque is required on housings with O-ring gaskets than with flat gaskets.

The applicable maximum torque values for the bolts must not be exceeded. When using standard equipment and normal physical strength these torque values will not be exceeded. When using extensions on spanners, wrenches or an air gun make sure that the bolts are not over tightened. The recommended maximum bolt torque values are listed below.

Please note:

If the pressure equipment is equipped with segment clamp screws it is essential that all the required clamp quantities are engaged (see cover sheet or vessel name plate).

| Max torque in Nm | | | | | | |
|-------------------------|-----|-----|-----|-----|------|-----|
| Metric ISO thread | M12 | M16 | M20 | M24 | M 27 | M30 |
| Hex/ring-nut/ thru bolt | 36 | 86 | 168 | 290 | 425 | 580 |
| Segment clamp screw | - | 80 | 200 | 340 | 550 | 680 |

These are reference values and are valid for typical zinc plated bolts of strength class 5.6 according to DIN 267, or zinc plated segment clamp screws made of 21CrMoV57.

Application of high force to the bolts to close a leaking pressure equipment (to overcome a damaged gasket) must be avoided. Over-tightening may damage bolts or the housing cover lid. To avoid stress in the cover tighten the bolts in accordance with the following sequence:

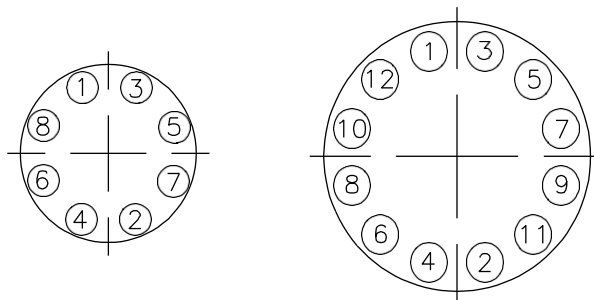

When using maximum allowable torque the bolts are to be tightened in three steps.

1. 50 % of torque
2. 80 % of torque
3. Max torque

To close SIDELINE bag filters with a center bolt closure. Hand-tight pressure on the center bolt will be sufficient to seal the housing. Tools to give extra leverage should not be used otherwise the mechanism is likely to be damaged. Check that the holding bar is properly positioned so that it will not slip out under pressure.

Filter housings with QIC-LOCK quick closure mechanism are closed by hand. Where a hex-nut is used in place of the spindle wheel the applied torque must not exceed 200 Nm. The pressure-release device must be locked down in place to complete the closure. The V-clamp is now locked.

4.4 Start up

The filter is now ready for use. Slowly open the valve on the inlet; avoid opening too fast as shock loads can damage the filter media and the housing. The vent valve should be open to ensure no air is locked in the top of the filter housing. The valve should be closed as soon liquid runs out. In all cases (whether or not hazardous liquids are being filtered) precautions should be taken to prevent injury from spraying liquid.

If the filter is not vented any air in the filter will reduce the efficiency of the filter media. Generally, if air gets into the system it should be vented off immediately. When filtering gaseous fluids, the filter should be vented at regular periods.

The outlet valve is now to be opened slowly.

Due to the fact that filter bags may release some particles when first used, we recommend re-circulation of the filtrate. The length of time for re-circulation will depend on the individual filter bag and level of filtration. This will ensure particles from newly installed filter bags will be collected and safely removed from filtrate.

5.0 Use, handling and maintenance

5.1 Use and Handling

To achieve maximum results from the equipment we recommended that adequate training be provided to all users and maintenance personnel. This manual should be part of this training. The training should also include: the correct and safe operation of the equipment, process requirement, type of filter, types of media, and special treatment of fluids and general safety rules.

The equipment must not be incorrectly used and measures should be taken to prevent this. Incorrect use includes:

- exceeding of the permissible pressure rating or temperature
- filtration of non-compatible fluids
- use of incorrect spare parts (e.g. bolts and gaskets)
- exceeding of permissible component load
- operating errors like opening under pressure or improper emptying or filling

Possible consequences with damage to persons or property may be:

- failure of the pressure equipment (bursting or exploding)
- emission of hazardous fluids (toxic, caustic, flammable).
- leakage and corrosion

Control systems (pressure and temperature) must be checked regularly for proper function. If the use of the pressure equipment has an associated risk due to the nature of the fluid and/or the operating conditions it is recommended to record the inspections. The operator should have access to the file (pressure equipment book) at any time.

5.2 Maintenance of the filter housing

The filter itself does not need any special maintenance with normal use. All parts should be regularly checked for corrosion and other damage.

Install a new filter bag at every product change or if the bag becomes dirty and is no longer efficient. Differential pressure (the difference in pressure before and after the filter) will determine if this point has been reached.

Eaton recommends changing the filter bag at a differential pressure of 1.5 bar, however, a maximum of 3.5 bar is permissible.

To remove the filter bag release the pressure in the housing by opening the pressure relief valve. The procedure for opening and closing the housing is described in Section 4. Attention should always be given to the gaskets and sealing surfaces ensuring that they are clean and undamaged. Damaged gaskets should be replaced

**Note:**

Eaton joins many gasket manufacturers in recommending that gaskets be replaced whenever a pressurized container is opened. Going against this recommendation may result in a faulty seal and a defect in the system. In practice, gaskets are often used many times.

It is important to verify that the correct gasket is being used. This applies to the size and the material of the gasket

If the filter housing contains movable parts, (e.g. QIC-LOCK spindle closure) these need to be lubricated to ensure easy movement. Common grease—which is compatible with the process—may be used. The parts should not be over greased. Greasing is also recommended for all threads. Stainless steel bolts should always be greased with an adequate lubricant to avoid premature wearing of parts.

Special models, such as TTBF with central T-bolt also need to be lubricated in the proper areas. Usually lubricating nipples are provided on these models.

Adequate cleaning and maintenance of all equipment is necessary at all times for trouble free operation. Where a potential hazard exists for operators, such as material escaping or the process itself, we recommend that all service and maintenance be documented, especially the condition of the seals and sealing surfaces and the function of moving parts.

If the filter housing is protected from corrosion through an applied coating a regular check of the surface to identify possible damage is important. Any damage to the coating should be repaired professionally.

Security equipment, such as pressure monitoring equipment, pressure relief systems on quick-closure mechanisms, locking devices, seal breaking devices, pressure measurement equipment, temperature control devices, leakage warning systems, etc., must be regularly tested for proper operation and repaired immediately in the case of malfunction.

The QIC-LOCK closure mechanism is equipped with an enforced locking device at the spindle. This device is linked to the pressure release vent. Its correct operation is to be verified with each opening and closing of the housing. Any malfunction should be corrected before the pressure vessel is put into service.

5.3 Recurring inspections

This section describes the scheduled maintenance and operation of pressure vessels. Maintenance schedules may be defined by national or local codes and regulations or plant norms. The operator must ensure that governing regulations are known and adhered to. We recommend that all servicing and maintenance be documented.

6.0 Maintenance of the spring-assisted lid lift (only MAXILINE Series Types)

The spring lifting and stainless steel device operates mechanically and can be adjusted. Even heavy housing covers can be close to weightless with its support, while the cover remains still in position.

6.1 Maintenance

The quick closing mechanism does not require any special maintenance.

Sounds made by the spring lifting device (jarring or grating) have no influence on the function of the lifting device, but can be reduced by spraying with a lubricant. In adverse conditions there may be risk of corrosion of weight bearing parts and a failure of the spring. The spring is only under tension when the housing is closed and relaxes when the housing is opened.

Should the closure fail, it would usually be under full tension when the cover is closed.

It would be a rare occurrence for the closure to fail. See also security measures for more details. Should the spring-assisted lid lift fail unexpectedly the housing cover may not be opened unless secured with a rope or chain.

6.2 Adjustment

The spring lift device is balanced at the factory before the housing is shipped. The addition of equipment, gauge, valves etc. may increase the weight of the cover making a new adjustment necessary.

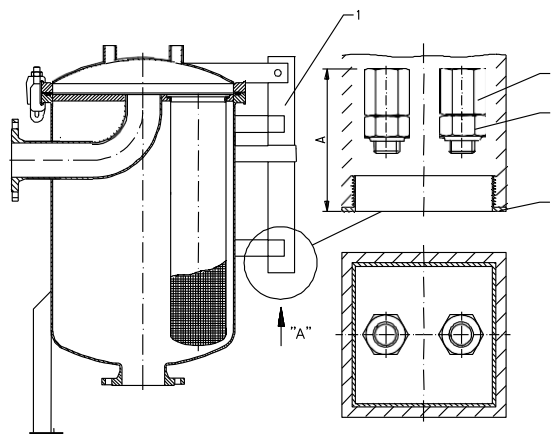

For re-adjustment the dust cap below the spring lift device is to be removed. When viewed from below two threaded bars with hexagon nuts can be seen. Two hexagon nuts are secured with additional self-securing hexagonal nuts to guard against misalignment and removal through counters. The counter hexagon nuts must be loosened.

Turning of both hexagon nuts adjusts the lifting capacity of the spring. Turning the nuts to the right (clockwise) increases the tension and bearing capacity. Turning the nuts to the left (counter clockwise) reduces the tension and bearing capacity.

After the adjustment the counter hexagon nuts are to be tightened. The dust cap can now be put into place again. Measurement A may not be exceeded 200mm respectively go not under the limit of 80mm in the final position (open and closed).

6.3 Caution

The spring lift device must be protected against aggressive and corrosive materials. If the spring lift device is in a high humidity environment, such as cleaning operations with steam cleaners there is a risk of corrosion. If this risk exists please contact the manufacturer to be consulted further.

We recommend the filter be installed so that no personnel can reach under the spring lift device. Never place your head under the spring lift device for maintenance work.

Always use a mirror for visual inspection. The spring lift device is very safe, but during operation should be placed under the lifted weight, which is true for all heavy items.



Important:

The removal and maintenance of the spring lift device may only be done when the cover is opened (usually upright position of the cover). Under tension the spring contains potential energy. This energy may be released suddenly and can lead to serious damage to people and property.

7.0 Technical Data

Measurements, details, spare parts and other materials can be found on the current Datasheets and Sales Drawings and full drawings if these are part of the full documentation package furnished with the housing. Missing Information can be requested from Eaton by providing the serial number of the housing.

8.0 Filter housing with heating jacket

For external heating or cooling the filter housings can be fabricated with an integral jacket, which can be operated using either liquid or gaseous products for heating or cooling as required. Before installation check operating parameters. Compare them with the design data of the filter housing details, which can be found on the nameplate. Do not exceed the specified operating pressure and temperature.

Exceeding the permissible operating conditions should be avoided by use of equipment such as pressure relief valves.

Heating media materials that come into contact with the housing have to be checked in regards to their chemical compatibility with the housing.

Because of the number of possible applications Eaton can make only limited recommendations. The responsibility for defining the correct materials for a specific application is the sole responsibility of the operator or user. Eaton does not assume any liability or provide guarantees for correctness.

In regards to the heating media the flow direction is to be chosen such that adequate venting of the jacket is guaranteed. Otherwise a portion of the surface will not be available for heating.

The heating media should usually enter from the bottom and exit at the top. This makes venting easy. With gas or steam the directions should be reversed. This is so that any condensate that develops can easily be removed from the bottom. Refer to Residual Hazards as described under Point 1.1.

9.0 Information about bag filters with coatings

Depending upon the application a bag filter housing may be coated on the inside and/or outside as a protection against corrosion. A standard coating is E-CTFE (HALAR). Other coatings like PFA, Epoxy or PA may also be used.

The suitability of the coating must be checked carefully against its chemical resistance, temperature resistance, mechanical tension, abrasion, etc. Installation and start-up should be done according to the operating instructions however special care should be taken to avoid any mechanical damage to the applied coating.



Powering Business Worldwide

Special attention must be paid to the maintenance of filter housings with an applied coating. The coating is used as a protection against corrosion. The coating put on is totally non-porous, no diffusion occurs, so it offers high chemical resistance and excellent corrosion protection. Mechanical damage of the coating must be avoided.

No work should be performed on the filter with tools or parts that could damage the coating. Particular care should be taken during regular maintenance of the filter and filter bag exchanges. Do not use the filter if the coating is damaged. Damaged coatings should be repaired and over time in demanding applications it may be necessary to re-coat the entire housing.

Technical data on coatings is available on request from Eaton.

10.0 General operating instructions

Filter bags that are used in the filter housings are usually made from industrial felt, monofilament mesh or melt-blown micro-fibers. In addition, strainer baskets are also used for coarse filtration. For technical details please refer to the appropriate literature.

The velocity of the flow of the process fluid through the filter is a major factor in achieving good as well as economic filtering results. The goal, with a few exceptions, is to keep the velocity as low as possible. Low pressure on the filter enhances filtration and increases the service life of the filter bag, thus reducing the operating cost of the whole system.

At the same time the flow should be as even as possible, for a feed pump a centrifugal pump is a better choice than a piston-driven one which delivers pulsating velocities. As a rule it is better to avoid uneven feed or intermittent operation as much as possible to prevent backup-up in the filter housing.

Such conditions could cause the filter bag to lift up and float with pressure changes in the filter housing so that it no longer fits exactly in the restrainer basket. At worst, this could result in a bursting of the filter bag. Filter bag lift up can be effectively prevented by the use of an optional bag-positioning device.

11.0 Use with Strainer Baskets

Depending on the application the filter system may be used with metal strainer baskets instead of the filter bags. The strainer basket replaces normally the restrainer baskets but where applicable the housings may be equipped with only one strainer basket with special dimensions, i.e. a 4 bag sized housing is equipped with one basket with a larger diameter instead of 4 baskets with the standard dimensions.

From experience strainer baskets are used for safety filtration (low solid removable) or to separate larger amounts of solids (high weight). Therefore it has to be observed that in case of basket changing or cleaning an adequate lifting device is used and precautions are taken to protect persons and equipment. Depending on the type of strainer basket there is the danger of squeezing fingers during insertion into the housing. The insertion should be done carefully.

The cleaning of the baskets has to be done carefully depending on the design of the basket.

The filter media may be a very thin and the stainless steel screen easily damaged. Cleaning with a high pressure cleaner or steam pressure cleaner is recommend only if cleaning is done in the flow direction.

Cleaning against the flow direction (screen is normally not supported) will consequently damage the basket.