

Green Motion Building User manual



Powering Business Worldwide

DISCLAIMER OF WARRANTIES AND LIMITATION OF LIABILITY

The information, recommendations, descriptions and safety notations in this document are based on Eaton's experience and judgment and may not cover all contingencies. If further information is required, an Eaton sales office should be consulted. Sale of the product shown in this literature is subject to the terms and conditions outlined in appropriate Eaton selling policies or other contractual agreement between Eaton and the purchaser.

THERE ARE NO UNDERSTANDINGS, AGREEMENTS, WARRANTIES, EXPRESSED OR IMPLIED, INCLUDING WARRANTIES OF FITNESS FOR A PARTICULAR PURPOSE OR MERCHANTABILITY, OTHER THAN THOSE SPECIFICALLY SET OUT IN ANY EXISTING CONTRACT BETWEEN THE PARTIES. ANY SUCH CONTRACT STATES THE ENTIRE OBLIGATION OF EATON. THE CONTENTS OF THIS DOCUMENT SHALL NOT BECOME PART OF OR MODIFY ANY CONTRACT BETWEEN THE PARTIES.

In no event will Eaton be responsible to the purchaser or user in contract, in tort (including negligence), strict liability or otherwise for any special, indirect, incidental or consequential damage or loss whatsoever, including but not limited to damage or loss of use of equipment, plant or power system, cost of capital, loss of power, additional expenses in the use of existing power facilities, or claims against the purchaser or user by its customers resulting from the use of the information, recommendations and descriptions contained herein. The information contained in this manual is subject to change without notice.

Content overview

1	INTRODUCTION.....	4
	1.1 Scope of the document.....	5
	1.2 Symbols used in this manual.....	5
2	CAUTIONS.....	6
3	OPERATING ENVIRONMENT AND RESTRICTIONS	6
4	DISCOVER YOUR GREEN MOTION BUILDING EV CHARGER.....	7
	4.1 Box contents.....	7
	4.2 Overview	7
	4.3 Types of cables.....	12
5	USER INTERFACES.....	13
	5.1 LED indicator	13
	5.2 Energy meter.....	14
6	RFID CARD AUTHENTICATION	15
7	HOW TO START AND STOP CHARGING.....	15
8	MAINTENANCE	17
	8.1 Software updates.....	17
	8.2 Disposal	17
9	TROUBLESHOOTING	18
10	TECHNICAL DATA.....	19
	10.1 Rating plate.....	19
	10.2 Technical datasheet.....	20
11	PRODUCT GUARANTEE AND TECHNICAL SUPPORT.....	20

1. Introduction

Thank you for choosing the Green Motion Building electric vehicle (EV) charger.

Green Motion Building is an AC EV charger specifically designed for use in private and public parking facilities for multi-residential, light commercial and industrial applications. It can be fixed to the wall or on a floor-mounted column, either indoor or outdoor.

Before you start

This manual contains important instructions that must be followed during the installation, operation and maintenance of the Green Motion Building electric vehicle charger. All instructions must be read before installing and operating the equipment. This manual should be retained for future reference.

Please note that the Green Motion Building EV charger must only be installed and maintained by professional and qualified personnel, i.e., an Eaton technical support representative or professional installer. Professional and qualified personnel must be expert in the field and must therefore be responsible for commissioning the system in accordance with the manufacturer's instructions and ensure that all steps of the installation, operation and maintenance comply with local legislation.

There are no user-serviceable parts inside the equipment. Failure to observe the above will void the provided product guarantee and Eaton cannot be held legally accountable.

The contents of this manual are the copyright of Eaton and may not be copied, reproduced or redistributed in whole or in part without Eaton's prior written permission. While every care has been taken to ensure the accuracy of the information contained in this manual, Eaton assumes no liability for any error or omission. Eaton reserves the right to modify the designs of its products. The unauthorized copying and lending of this manual is prohibited.

Technical disclaimer

All drawings, descriptions or illustrations contained in this document serve to provide a clear overview and/or technical explanation of the present product and its various components and accessories. In line with our goal to continuously improve the products and the customer service we provide, all specifications contained in this document are subject to change without notice, as Eaton reserves the right to modify the designs of its products.

Legal entity

Eaton Industries Manufacturing GmbH

Address: Place de la Gare 2
1345 Le Lieu
SWITZERLAND

Web: www.eaton.com

1.1 Scope of the document

This manual is intended for users of the Green Motion Building EV charger. It describes the operating environment, the EV charger and its features. The document does not cover installation, removal and commissioning guidance. For installation instructions, refer to the installation manual available on www.eaton.com/greenmotionbuilding. Please note that the EV charger must only be installed by professional and qualified personnel, i.e., an Eaton technical support representative or a professional installer.

1.2 Symbols used in this manual



Imminent danger of causing serious injuries or death.



Hazardous behaviors that could cause serious injuries.

Hazardous behaviors that could cause death.



Behaviors that could cause minor injuries to people or minor damages to property.



Risk of electric shock that can be fatal.

Avoid touching internal or external parts normally live while the system is powered on.



Notes preceded by this symbol relate to technical issues and ease of operation.



The EU Directive on Waste Electrical and Electronic Equipment (WEEE).

2. Cautions



Before carrying out any operations, ensure you have read and understood this manual. Do not make changes and do not carry out maintenance operations not described in this manual. The manufacturer does not accept responsibility for injuries and property damages because the information within this manual has not been read and followed.



Installation, commissioning, maintenance and retrofitting must be carried out only by professional and qualified personnel.



It is strictly prohibited to open the EV charger.

3. Operating environment and restrictions

Each system must be used exclusively for the operations it was designed for and within the operative ranges specified on the rating plate and/or in the relevant technical datasheet, in accordance with the national and international safety standards.

Any use different from the intended use specified by the manufacturer is to be considered totally inappropriate and dangerous and in this case the manufacturer declines all responsibility.



Check the regulations applied by the electricity provider.

The unit can be connected to the distribution network in accordance with local rules.

The unit should only be used in accordance with the technical specifications.



Improper or unauthorized use:

Although carefully constructed, like all electrical appliances the unit can catch fire.

The unit is suitable for both indoor and outdoor installation.

Optimal operation of the unit is in the temperature range -25 °C to +45 °C.

The unit must be transported and stored in indoor locations in the temperature range -25 °C to +45 °C.

The unit must be used in locations free from acids, gases or other corrosive substances.

The unit must be used and stored in locations with relative humidity below 95 %.

The unit must be transported in conditions with relative humidity below 95 %.

The unit must be used below a maximum altitude of 2000 m above sea level.

4. Discover your Green Motion Building EV charger

4.1 Box contents

The Green Motion Building EV charger box contains the following items:

- Green Motion Building EV charger
- Quick start guide
- Safety guidelines
- Drilling template
- Four adhesive gaskets
- Floor-mounted column (optional)
- Cable holder (optional).
- EV connector
- Spacers (T2S with shutter model)
- Ethernet connection kit

4.2 Overview

Here is an overview of the Green Motion Building EV charger.

a. Product references

Reference	Description
GMB2202BCAA00A00	GMB 3.7-22kW T2S MID 4GS
GMB2201BBAA00A00	GMB 3.7-22kW T2 Socket MID 4G
GMB2203BAAA00A00	GMB 3.7-22kW 5m T2C MID
GMB2203BBAA00A00	GMB 3.7-22kW 5m T2C MID 4G
GMB2201BAAA00A00	GMB 3.7-22kW T2 Socket MID
GMB2202BAAA00A00	GMB 3.7-22kW T2S MID
GMB2202BBAA00A00	GMB 3.7-22kW T2S MID 4G

b. Accessory references

Referene	Description
XCI3025221	Cable holder
XCI3025021	Foot-mounted column for one charger
XCI3025121	Foot-mounted column for two chargers
XCI000411	RFID Card x 5
GMA02AI000000A00	N.1 ethernet extender kit
GMA02AL000000A00	N.2 ethernet extenders kit

Figure 1. Overview of the Green Motion Building EV charger

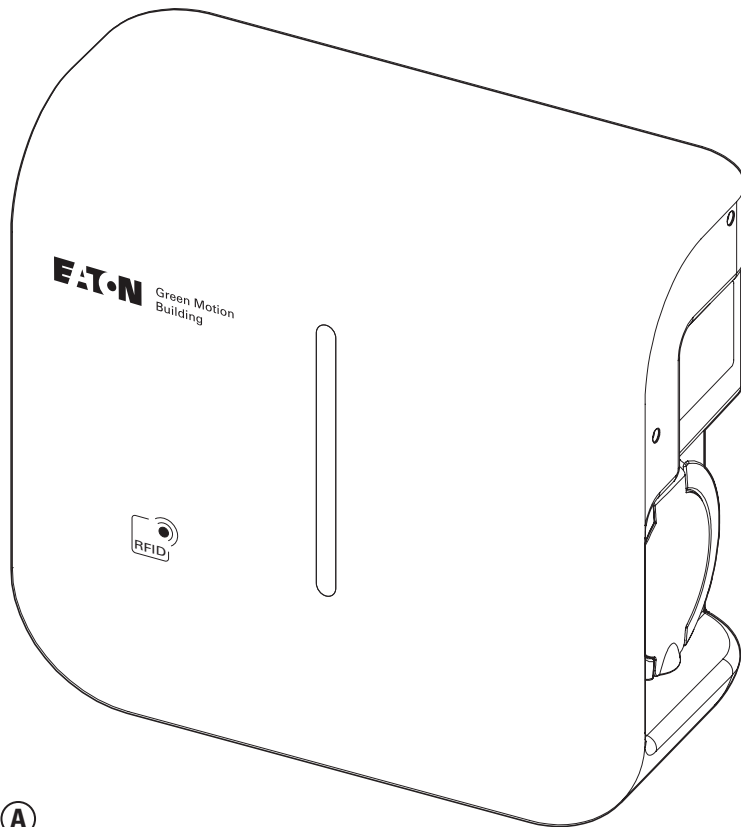

A

Tag	Description
A	Green Motion Building EV charger with Type 2 female socket

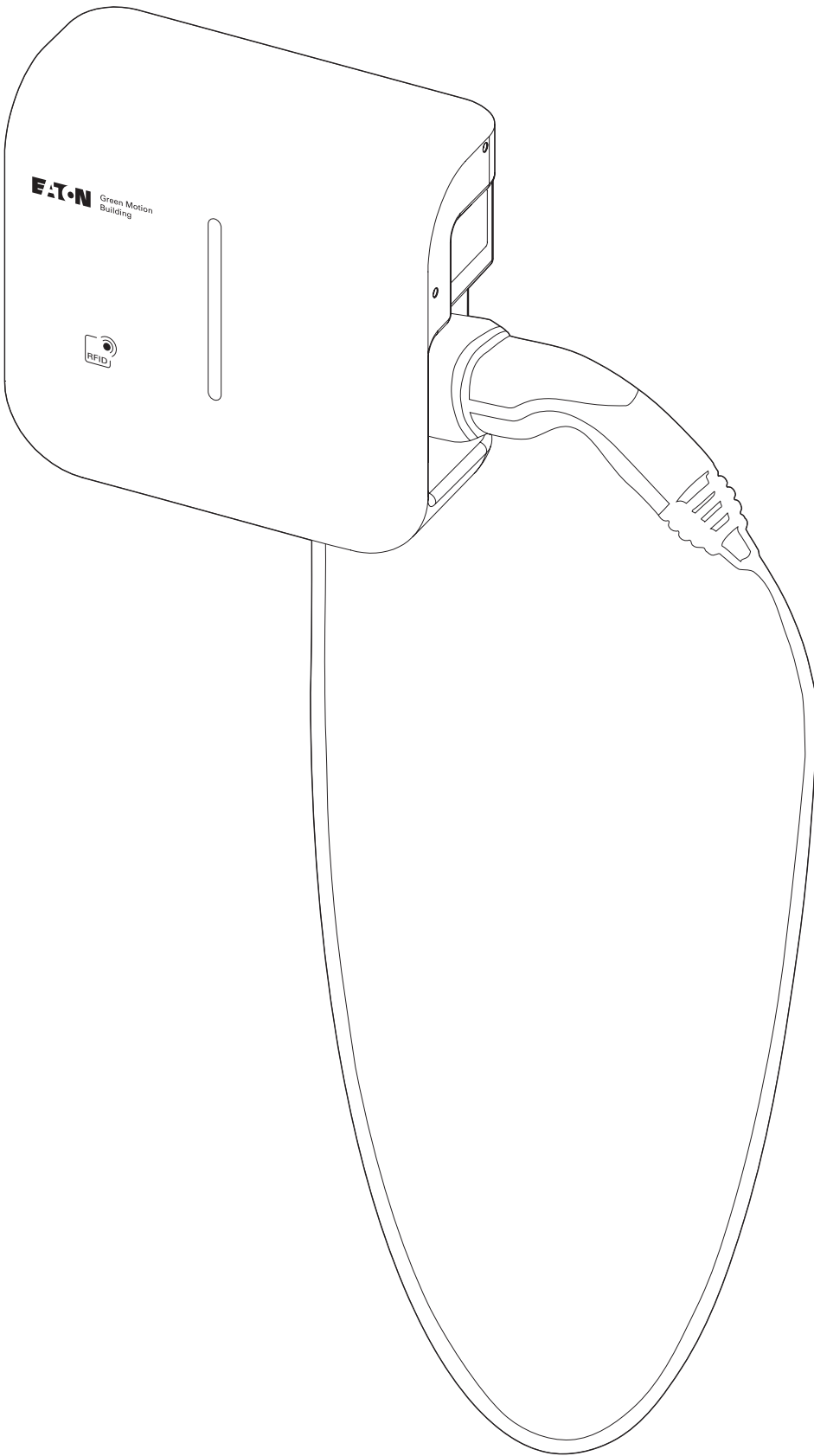

Ⓑ

Tag	Description
-----	-------------

Ⓑ	Green Motion Building EV charger with Type 2 cable
---	--

Figure 2. How to mount the Green Motion Home EV charger (non-T2S version) on a wall

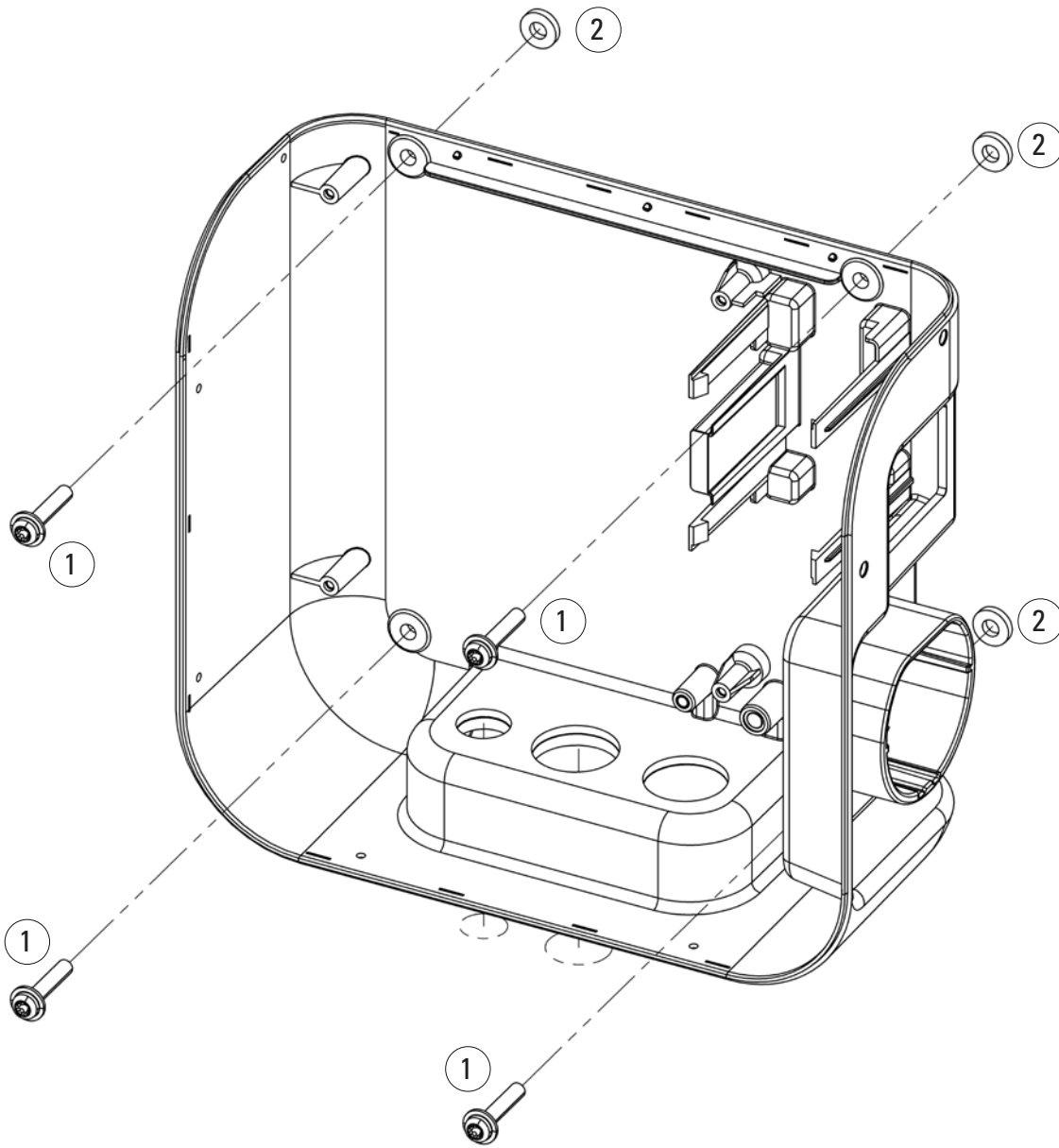

Tag	Description
①	Ø6 mm screws
②	Gaskets

Figure 3. How to mount the Green Motion Home EV charger (T2S version) on a wall

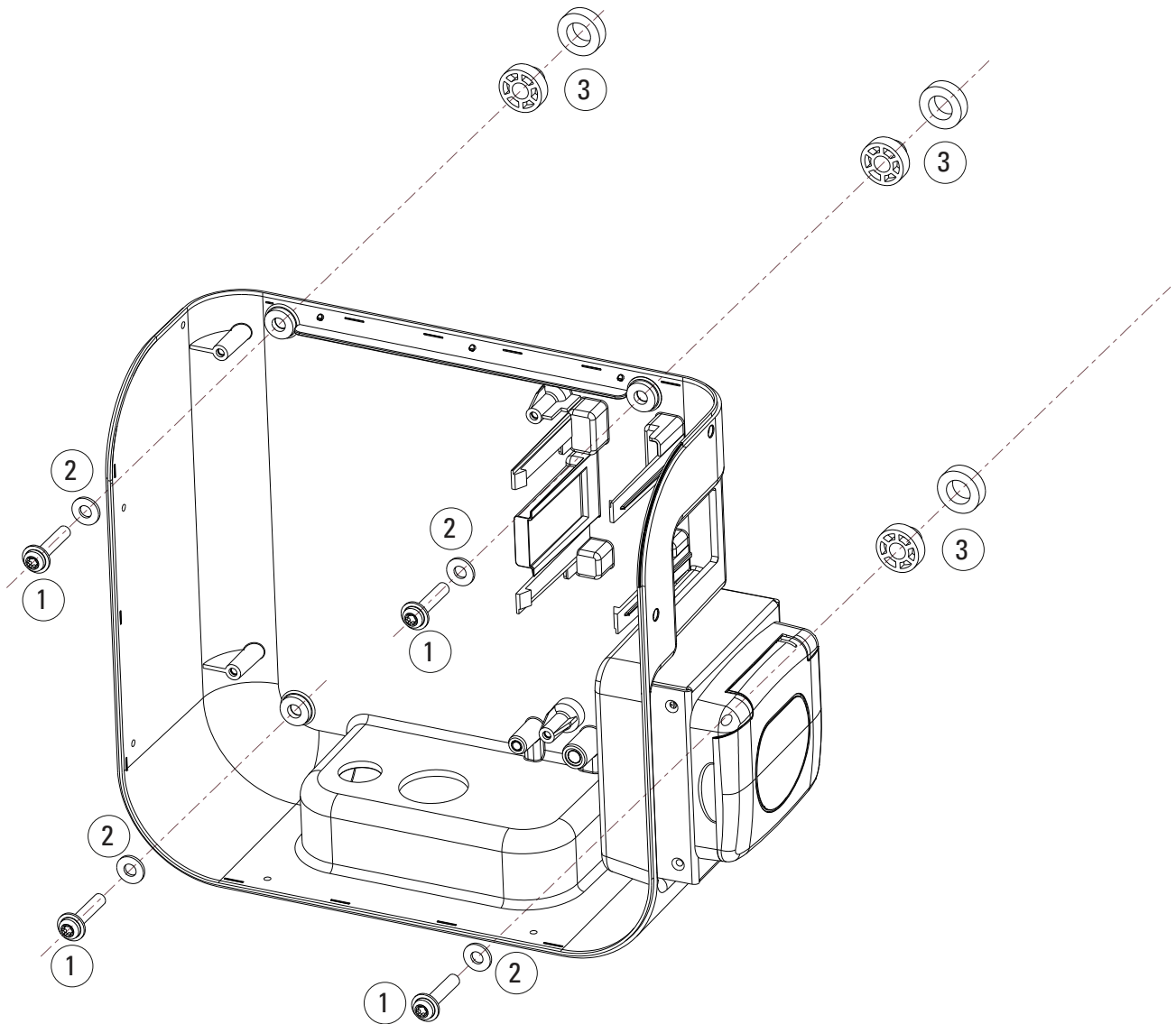

Tag	Description
①	Ø6 mm screws
②	Gaskets
③	Spacers

4.3 Types of cables

The Green Motion Building EV charger is provided with one of two possible types of connections:

- Type 2 connector with cable (Mode 3), 230 V/400 V 32 A for either single or three phases.
- Type 2 connector with female socket (Mode 3).

Figure 4. Illustration of Type 2 connector

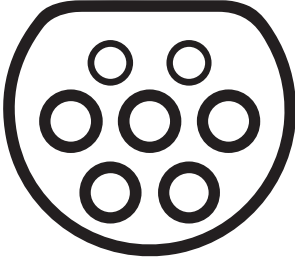

5. User interfaces







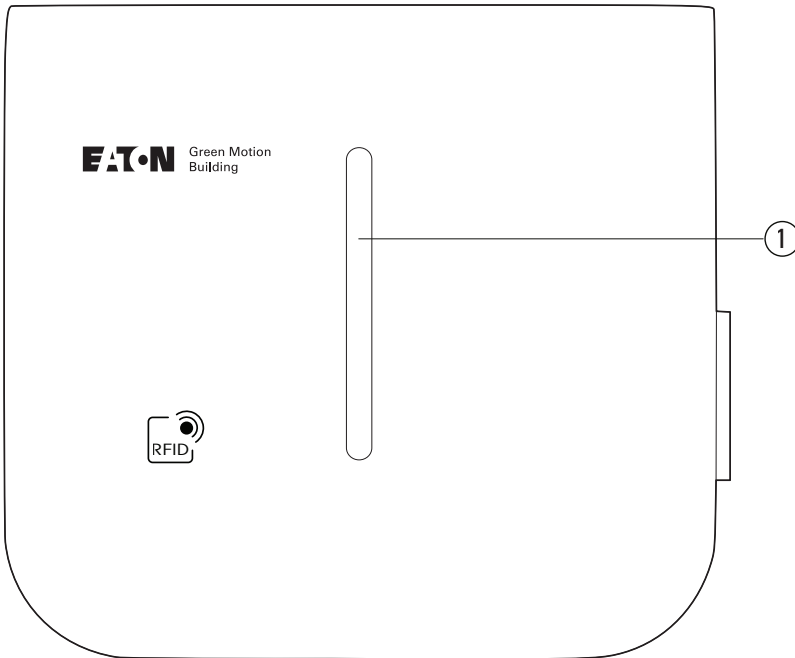



5.1 LED indicator

The LED indicator is a vertical light bar on the front cover of the EV charger indicating the status of the EV charger by lighting up in distinct colors and accompanying patterns as shown below.

Figure 5. LED indicator on front cover of the EV charger



Tag	Description
①	LED indicator

LED Color	LED state	Description
	Solid	EV charger ready for use.
	Pulsing	EV charger is waiting for user command to start via app.
	Solid	The vehicle is fully charged/vehicle charging limit reached.
	Pulsing	Charging session is initializing.
	Progress	Charging in progress.
	Solid	Charging error or mechanical fault. Try restarting from the fuse box. Contact technical support if the issue persists.
	Flashing	Action failed, try again. Contact technical support if the issue persists.
	Flashing	Network error. EV charger cannot connect to the Internet/back-end. Check that the Wi-Fi is connected and the password has not been changed.
	Pulsing	An update is in progress.
	N/A	EV charger has no power.



5.2 Energy meter

The MID compliant Green Motion Building EV charger is equipped with the energy meter Iskra WM3M4.

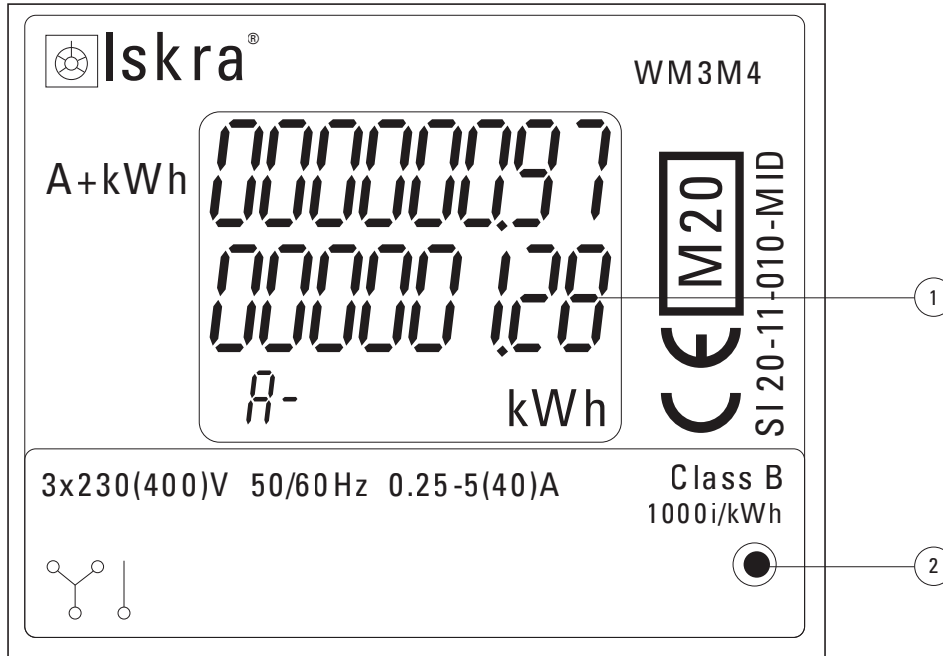
Figure 6. Energy meter display



Tag	Description
①	Total energy consumption
②	LED light

Energy meter indicator	Description
Energy meter display	The display of the energy meter shows the total energy consumption in kWh since the first switch-on of the EV charger. See Figure 4.
	LED light off: no car connected.
	LED light blinking: a car is connected and charging.
	Solid LED light: a car is connected, but not charging.

6. RFID card authentication

6.1 Enabling/disabling authentication

The Green Motion Building EV charger can be used with or without authentication using RFID cards. By default, authentication is with RFID cards. Disabling the authentication requirement can be done in the configuration page of the Green Motion Building EV charger. Read the installation manual of the Green Motion Building on www.eaton.com/greenmotionbuilding for more information.



Changing the settings on the configuration page of the Green Motion Building EV charger must be done by professional and qualified personnel.

6.2 Registering RFID cards

RFID cards allow authentication for the Green Motion Building EV charger and provide a means for payment. The RFID cards can be registered through the Eaton Charging network manager. Read the user manual of the Charging network manager on www.eaton.com/chargingnetworkmanager or connect with technical support representative using the email address BGTechSupport@eaton.com for more information.

The Green Motion Building EV charger is compatible with ISO14443 and ISO15693 RFID cards.

7. How to start and stop charging



Electrical systems or devices must be checked by professional and qualified personnel before commissioning and switching on the unit for the first time.

How to start a charging session:

- Step 1.** Check that the EV charger is ready for use. Please refer to Section 5.
- Step 2.** Connect the cable of the EV charger to the appropriate socket of the car or use the cable of the EV owner to connect to the socket of the EV charger. To remove the connector from its holder, pull it first vertically and then horizontally. See Figure 5.
- Step 3.** By default, the charger is configured to require authentication with a RFID card:
 - Pass the RFID card in front of the charger to authenticate, the charge will start after successful authentication.

If the charger is not configured to require authentication, the charging session will automatically start after the charger is connected to the car (**Step 2**).

- While the vehicle is charging, the Green Motion Building LED indicator flashes blue.
- When the battery is fully charged, the Green Motion Building LED indicator is solid blue.
- Please refer to Section 5 for more information.

Figure 7. Removing the plug from the EV charger

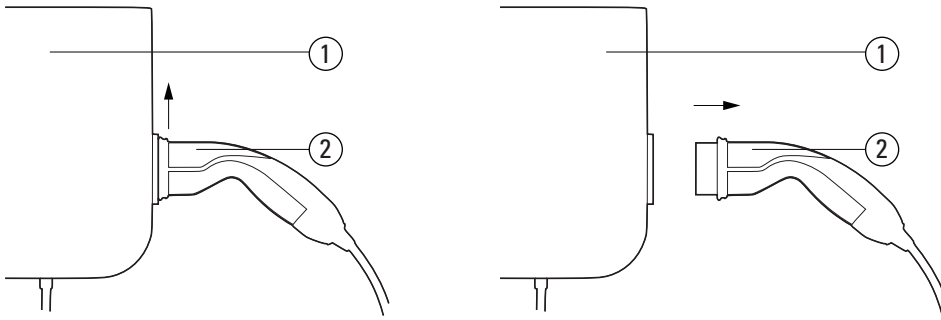

Tag	Description
①	Green Motion Building EV charger
②	Type 2 connector

How to stop a charging session:

Step 1. Unplug the connector from the vehicle and/or the EV charger. Usually, the connector must first be released from inside the vehicle (please refer to the instruction manual of your vehicle for more information). In case the charging session is authenticated with a RFID card, it is also possible to stop a charging session by passing the RFID card in front of the charger.

8. Maintenance



Installation, commissioning, maintenance and retrofitting of the EV charger must be performed by professional and qualified personnel who are responsible for complying with existing standards and local installation regulations.



Before making any changes or alterations to the EV charger, make sure that the external AC line main switch is disconnected, and that circuit breakers are open.



Any operation requiring the opening of the housing of the EV charger can lead to electric shock hazards.

The opening of the EV charger as well as any configuration changes must be carried out by professional and qualified personnel in accordance with the local safety and electrical regulations and laws.

8.1 Software updates



It is mandatory to install and maintain units with the latest system update to enable new features and bug fixes or the product guarantee may be voided. For units that are online, system updates will be automatically downloaded and installed when available. Please refer to the technical documentation available on www.eaton.com/greenmotionbuilding for further details. For units that are offline, please contact your Eaton technical support representative using the email address BGTechSupport@eaton.com.

EV Charger will not perform an upgrade while an active charging session is in progress.

EV charger will not be available for charging when an upgrade is in progress

8.2 Disposal

When disposing of the EV charger, the end user should contact professional and qualified personnel for disposal instructions. Please refer to www.eaton.com for further details.



The EU Directive on Waste Electrical and Electronic Equipment (WEEE) (Directive 2012/19/EU) establishes common rules on the management of electrical and electronic equipment to minimize its impact — from design until disposal — on the environment. As a manufacturer of electrical and electronic equipment, Eaton actively supports the requirements of the WEEE Directive.

In compliance with the EU standard EN 50419 for marking of electrical and electronic equipment, we include the crossed-out wheeled bin symbol on our products. This symbol alerts users that these products should be recycled in accordance with local environmental regulations and not discarded with household waste.

When end-users recycle WEEE they are helping to ensure that it is neither incinerated nor sent to landfills, minimizing potential negative impact on human health and the environment.

Any device that is no longer needed must therefore be returned to the distributor or disposed of at an authorized collection point or recycling center. Eaton encourages all its customers and end users to make responsible decisions when it comes to disposing products.

Eaton is not responsible for the transportation of the device to the collection point or recycling center.

9. Troubleshooting



This section contains information and procedures for solving possible problems that may occur with the Green Motion Building EV charger.

If the problem persists, contact your Eaton technical support representative using the email address BGTechSupport@eaton.com.

<p>The Green Motion Building EV charger does not start charging.</p>	<p>Check that the EV charger is powered on (the LED indicator is green). Check that the connection between the charging cable and the car socket is properly established. When charging with a Type 2 connector, ensure that it is pushed in until an audible click is heard.</p>
<p>The Green Motion LED indicator is red.</p>	<p>There is an error or fault preventing a charging session to either start or resume. Attempt to reinitiate the charging session by unplugging the charging cable from the vehicle and reinserting it. If the problem persists, check any control messages displayed in the vehicle.</p>
<p>The Green Motion LED indicator is green, but the vehicle does not charge.</p>	<p>Check that the charging cable connector is adequately plugged into the vehicle. When charging with a Type 2 connector, ensure that it is pushed in until an audible click is heard. Some vehicles need to be locked before a charging session is allowed to start. Try locking the vehicle. Visually inspect the condition of the cable used for charging, its connector and sockets, the vehicle socket as well as the EV charger socket if using a Green Motion Building EV charger with a Type 2 female socket. Stop usage immediately if you see physical damage to any of these parts. Check that the vehicle does not have scheduled/delayed charging set up. In such cases it will only charge at certain hours of the day.</p>
<p>The connector will not release from your vehicle.</p>	<p>In most cases the charging cable must first be released/unlocked by the vehicle to prevent injuries, accidental disconnection and misuse. Try unlocking the vehicle first. Alternatively, refer to the vehicle instruction manual.</p>
<p>The plug for the 22 kW model does not release.</p>	<p>Due to the weight of the 22 kW connector cable, it is possible that the latch on your vehicle will not release. In this case, firmly hold the plug slightly upwards as you disconnect the plug from the vehicle.</p>

10. Technical data

10.1 Rating plate



To locate the rating plate on the equipment, refer to Figure 6.

The technical specifications shown in this manual do not replace those that appear on the rating plate attached to the equipment.



The labels attached to the equipment must NEVER be removed, damaged, soiled or hidden for any reason.

The labels must NOT be hidden by foreign objects (rags, boxes, equipment, etc.).

They must be cleaned periodically and always kept clearly visible.

Information reported on the rating plate:

1. Manufacturer
2. Model
3. Serial Number
4. Ratings
5. Warnings.

Figure 8. Location of the rating plate on the bottom side of the Green Motion Building EV charger

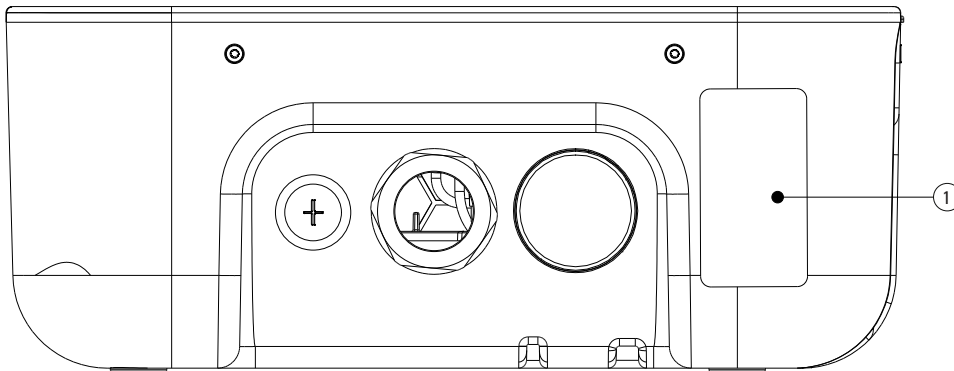

Tag	Description
①	Rating plate

Figure 9. Example of the Green Motion Building rating plate

Electric Vehicle Charging Station

GMB V2 22kW Cable T2 On-line MID

Catalogue Nb:XCI3672221-03001

S/N:TH35M3600F

Rated Voltage: AC 230 - 400V 50 Hz 3L + N + PE

Rated current: AC 32A

Rated temperature: -25°C to +45°C IP 54



CE COMPLIANCE CONTACT:

Eaton I.F.

110 rue Blaise Pascal

38330 Montbonnot St Martin

France

ENGINEERED IN SWITZERLAND
MADE IN SWITZERLAND



10.2 Technical datasheet

The latest version of the technical datasheet for the Green Motion Building EV charger as well as its CE Certification document are available for download on www.eaton.com/greenmotionbuilding.

11. Product guarantee and technical support

Should any technical problems arise during the warranty period of the Green Motion Building EV charger, contact your local installer or your Eaton technical support representative for assistance using the email address BGTechSupport@eaton.com.

The following information should be provided when contacting the Eaton technical support representative:

- Product model and serial number



Powering Business Worldwide

Eaton Industries Manufacturing GmbH

Place de la Gare 2
1345 Le Lieu, Switzerland
Eaton.com/greenmotionbuilding

© 2021 Eaton
All Rights Reserved
Publication No. MN191027EN
February 2023

Eaton is a registered trademark.

All trademarks are property of their respective owners.