

EATON

**xChargeIn M Series
Electric Vehicle Charging Station
Configuration manual V 1.01**

Translation of the original manual

EATON

Powering Business Worldwide

Document: V 1.01 / Document No.: 105726
Filename: EATON_xChargeInMSeries_konfen.pdf
Pages: 40

© EATON

Specifications are subject to change due to further technical developments. Details presented may be subject to correction.

All rights reserved.

Eaton Industries (Austria) GmbH

Eugenia 1, 3943 Schrems, Austria
techsupportemea@eaton.com, www.eaton.com/evc

Table of contents

1	Introduction	4
1.1	Representation of safety instructions	5
1.2	Purpose of the document	6
1.3	Requirements	6
1.4	Guarantee	6
1.5	Notes on this document	7
1.6	Further documentation	8
2	System overview	9
2.1	Network interfaces	9
2.2	Design of a local charging network (master/slave)	13
3	Configuration	16
3.1	Connection panel	16
3.2	DIP switch settings	16
3.3	Configuration via web interface	17
3.4	Enabling the DHCP server	24
3.5	Configuration in series via USB stick	24
4	Functions	28
4.1	Load management in the local charging network	28
4.2	RFID authorization	29
4.3	OCPP backend	33
4.4	UDP interface	34
4.5	Integration of external meters	34
5	Maintenance	38
5.1	Diagnosis and troubleshooting	38
5.2	Software update	38
	Index	40

1 Introduction

This document refers to the following devices:

xChargeIn M Series with software version 1.8 or a later version of the software

The device variant can be determined by the product designation on the type plate. The software version can be read out via the web interface. For more information, see the "operating instructions".

The pictured devices used in this manual are visual examples. The figures and explanations contained in this manual refer to a typical device design. The devices used by you may differ in their appearance.

1.1 Representation of safety instructions

At various points in this manual, you will see notes and precautionary warnings regarding possible hazards. The symbols used have the following meaning:



DANGER!

indicates an imminently hazardous situation, which will result in death or serious bodily injury if the corresponding precautions are not taken.



WARNING!

indicates a potentially hazardous situation, which can result in death or serious bodily injury if the corresponding precautions are not taken.



CAUTION!

means that if the corresponding safety measures are not taken, a potentially hazardous situation can occur that may result in slight bodily injury.

Caution

means that damage to property can occur if the corresponding safety measures are not taken.



ESD

This symbol reminds you of the possible consequences of touching electrostatically sensitive components.

Information

Identifies practical tips and useful information. No information that warns about potentially dangerous or harmful functions is contained.

1.2 Purpose of the document

This document describes the configuration of the advanced features of xChargeIn M Series after it has been installed. This includes, among other things, the description of the settings in the web interface.

This document is an extension to the supplied manuals of xChargeIn M Series.

You must comply with all instructions and safety instructions in the supplied manuals!

1.3 Requirements

This document contains information for persons with the following requirements:

Target group	Required knowledge and abilities
Electrician	<p>Person who, due to his or her special training, expertise and experience as well as knowledge of current standards, is able to assess the work performed and the possible hazards.</p> <p>Knowledge of:</p> <ul style="list-style-type: none"> • current valid safety information, • the mode of operation of the charging station, • the displays and operating elements of the charging station, • basics of network technology, • basics of IT, • diagnostic options, • systematic fault analysis and rectification, • the setting options on the charging station.

1.4 Guarantee

Only the maintenance work expressly permitted by Eaton may be performed. Any other manipulations to the device will also result in loss of warranty.



WARNING!

Danger due to electric shock and fire hazard!

After opening the front part, product safety can no longer be guaranteed.

Only the covers described in the instructions may be opened. If one of the covers is sealed by a lead seal, it is not permitted to be opened by unauthorized persons. If the lead seal is broken, the device loses its specific suitability and may no longer be put into operation due to the resulting incorrect marking.

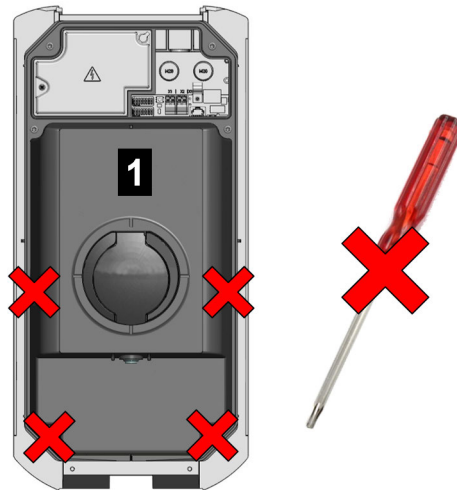

Fig. 1-1: Screws on front part

The front part **1** may not be opened. Opening the front part (4 Torx screws) will break the warranty seal and void the warranty. For a warranty claim, there is a duty of proof of the customer that the defect – which led to the defect of the device – already existed at the time of delivery. If the warranty seal is broken, this proof can no longer be provided, whereby the warranty claim expires.

A device with broken warranty seals or removed lead seals may no longer be put into operation. The necessary steps for replacement of the charging station by the specialist dealer or service partner must be initiated.

1.5 Notes on this document

The manual is part of the product. It is to be retained over the entire life cycle of the product and should be forwarded to any subsequent owners or users of the product.

The instructions contained in this manual must be followed precisely. Failure to do so could result in the creation of potential sources of danger or the disabling of safety devices. Apart from the safety instructions given in this manual, the safety precautions and accident prevention measures appropriate to the situation in question must also be observed.

1.5.1 Contents of the document

- Configuration of the advanced features of xChargeIn M Series

1.5.2 Not contained in this document

- Commissioning and deinstallation of the charging station
- Operating behavior of the charging station
- Operation of the charging station

1.6 Further documentation

Manuals and additional information are available on the Eaton website:

<http://www.eaton.com/evc>

Designation	Target group
Operating instructions	<ul style="list-style-type: none">• End customer• Electrician
Installation manual	<ul style="list-style-type: none">• Electrician
UDP Programmers Guide	<ul style="list-style-type: none">• Programmer
FAQ	<ul style="list-style-type: none">• End customer• Electrician• Service technician

2 System overview

With xChargeIn M Series, several charging stations can be interconnected in the form of a master/slave network. This makes charging with an intelligent load management possible. In addition, a connection to a higher-level OCPP backend can take place. The charging station is equipped with different network interfaces for these functions.

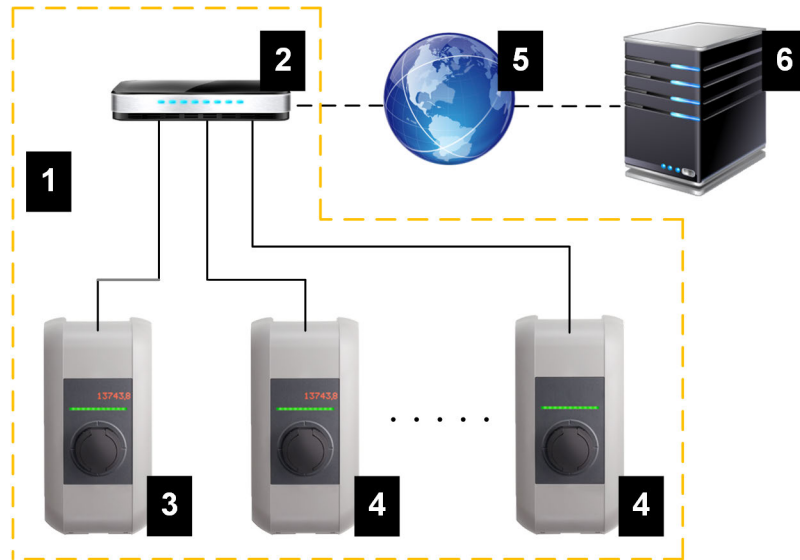

Fig. 2-2: Example network setup

1 ... Local charging network	2 ... Router/Switch
3 ... Master charging station (M Series)	4 ... Slave charging station (S Series)
5 ... Higher-level network/Internet	6 ... OCPP backend

Only xChargeIn M Series can be operated as master charging stations; only xChargeIn S Series can be operated as slave charging stations.

The following chapters describe which network interfaces xChargeIn M Series (master charging station) provides and how to set up a master/slave network.

2.1 Network interfaces

xChargeIn M Series provides the following network interfaces (e.g. for connection to an OCPP backend, ...):

- LAN
- WLAN (optional)
- WLAN access point (optional)
- GSM (optional)

Slave charging stations can only be connected via LAN to xChargeIn M Series (master charging station).

2.1.1 LAN

xChargeIn M Series can be connected to a router via the integrated LAN interface. The router provides a connection to an OCPP backend over the Internet.

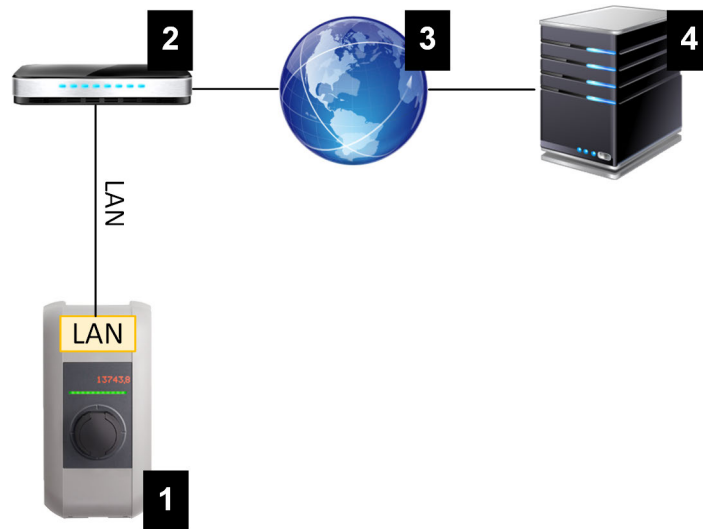

1 ... xChargeIn M Series	2 ... Router
3 ... Internet	4 ... OCPP backend

Connection: Ethernet1-Anschluss (LSA+®)

Via the LAN interface, xChargeIn M Series can also be connected to other charging stations, whereby a charging network can be realized.

Information

The Ethernet2 connection X3 (RJ45) is for diagnose purposes (debugging) only and may not be used to connect to a network.

The Ethernet1 connection X4 (LSA+®) and the Ethernet2 connection X3 (RJ45) are connected in parallel on the PCB and cannot be used at the same time! The connection that is not used must be unplugged from the charging station.

2.1.2 WLAN (optional)

xChargeIn M Series can be connected to a router via the integrated WLAN interface. If the router is connected to the Internet, a connection to an OCPP backend can be made.

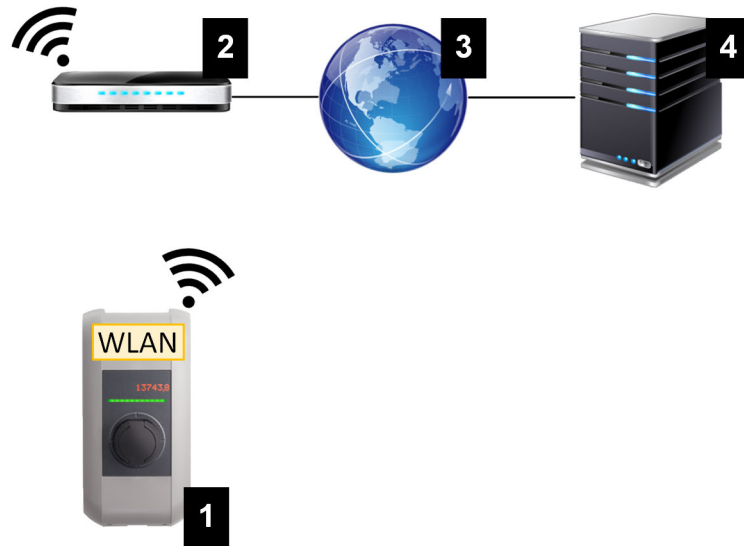

1 ... xChargeIn M Series	2 ... Router
3 ... Internet	4 ... OCPP backend

The technical data of the WLAN module can be found in the "Installation Manual".

Information

Only a charging station that is operated as a single charging station can be connected to the router via WLAN. A charging station that is part of a charging network (master/slave network) must always be connected to the router via LAN.

2.1.3 WLAN Access Point (Hotspot) (optional)

xChargeIn M Series can be connected to a mobile device via the integrated WLAN access point. With the mobile device, the web interface can be easily accessed and the configuration of the charging station can be performed.



1 ... xChargeIn M Series	
--------------------------	--

The access data and the IP address of the WLAN access point are listed on the configuration label. The configuration label is in a pouch which is enclosed with the mounting material.

The following steps are necessary to perform the configuration via a mobile device:

- 1) Connect a mobile device to the WLAN access point.
- 2) Access the IP address of the WLAN access point in a web browser on the mobile device.
- 3) Perform configuration via the web interface, see [3.3 Configuration via web interface](#).

2.1.4 GSM (optional)

Certain device variants have a GSM module. xChargeIn M Series with GSM can connect to an OCPP backend over the cellular network. The mobile communications provider may charge additional fees (depending on the tariff) for running data transmissions.

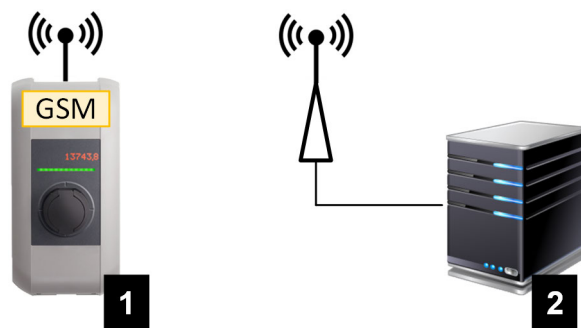

1 ... xChargeIn M Series	2 ... OCPP backend
--------------------------	--------------------

For the connection to an external OCPP backend via GSM, a SIM card must be installed during commissioning. In addition, GSM must be activated as connection to the OCPP backend and the access data of the mobile service provider must be set in the configuration (web interface).

The commissioning of the GSM module is described in the "Installation Manual". The technical data of the GSM interface and the SIM card can also be found in the "Installation Manual".

2.2 Design of a local charging network (master/slave)

A local charging network includes one xChargeIn M Series as master and up to 15 xChargeIn S Series as slaves.



Depending on the number of slave charging stations, the design of a local charging network is implemented differently:

- **1 slave charging station:** Direct connection
The slave charging station is connected directly to the master charging station.
- **Multiple slave charging stations:** Connection via router or switch
The slave charging stations are connected to the master charging station via a router or switch.

To enable communication between master and slave charging stations, the charging stations must be configured in the web interface, see [3 Configuration](#).

2.2.1 Displays and signals

The display on the front of the charging station provides information about which communication connection is established.

Display	Description
 blue blue blue blue	Communication is possible throughout the network. The master charging station and the OCPP backend are reachable.
 blue blue blue -	Communication between master and slave charging stations is possible. The OCPP backend is not reachable or missing.
 - blue blue -	Communication between master and slave charging stations is not possible. The OCPP backend is not reachable.

2.2.2 Direct connection of master and slave

A single slave charging station can be connected directly to the master charging station via LAN.

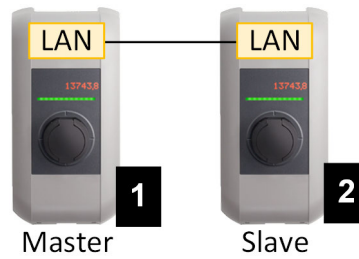

Fig. 2-3: Direct connection of master and slave

1 ... xChargeIn M Series (master)	2 ... xChargeIn S Series (slave)
------------------------------------------	-----------------------------------------

In this case, the master charging station must be configured as a DHCP server. The IP address is then assigned to the slave charging station by the master charging station.

2.2.3 Connection via router or switch

If there are multiple slave charging stations, these must be connected to the master charging station via a router or switch. The connection of the charging station to the router/switch is made via LAN

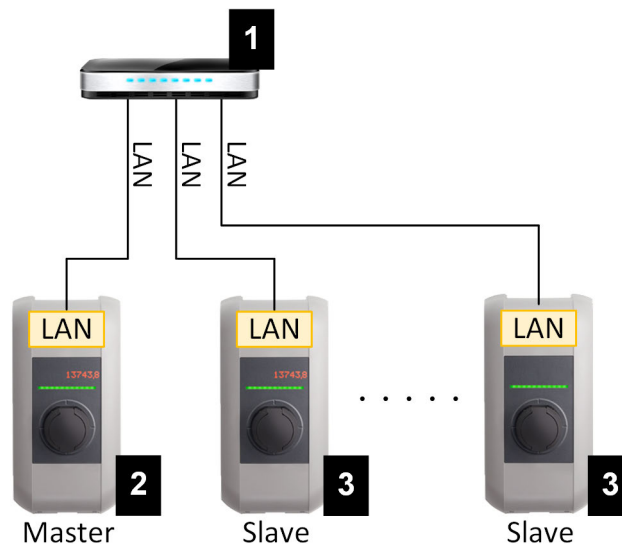

Fig. 2-4: Connection via router or switch

1 ... Router/Switch	2 ... xChargeIn M Series (master)
3 ... xChargeIn S Series (slave)	

Using a router

In a network connection using a router, the router automatically provides the functionality of a DHCP server in most cases.

Information

If the IP addresses are assigned externally (for example, by routers with activated DHCP server), the IP addresses must not be in the following range: 192.168.25.xxx

Using a switch

For a network connection using a switch, the master charging station must be configured as a DHCP server. The IP addresses are then assigned by the master charging station.

2.2.4 Ports for communication in the charging network

For the correct communication in the charging network, the ports below must be enabled network-internally.

Information

If necessary, contact your network administrator to enable the ports.

Port	Protocol	Definition	Description
49153	TCP	Within the network	Socket of the charging station
15118	TCP	Within the network	Link connection between the charging stations (SDP)
15118	UDP	Within the network	Link connection between the charging stations (SDP)
68	TCP	Within the network	Transfer of the software update (Bootps)
68	UDP	Within the network	Transfer of the software update (Bootps)
67	TCP	Within the network	Transfer of the software update (Bootps)
67	UDP	Within the network	Transfer of the software update (Bootps)

3 Configuration

This chapter describes the necessary configuration for the correct operation of the charging stations. The following steps are necessary for this:

- Set the DIP switch on the charging station
- Configuration (via the web interface or via USB stick)

Depending on the network configuration, activation of the DHCP server on the master charging station may be necessary.

3.1 Connection panel

In the connection panel of the charging station are important interfaces and controls for the configuration of the charging station. To access, the housing cover and the connection panel cover must be removed. The description of removing the covers and the connection panel can be found in the "Installation Manual".

3.2 DIP switch settings

This DIP switch setting must be made for each master and slave charging station to enable charging station communication.

Caution

Possible damage to the DIP switches!

The DIP switches are rocker switches and not slider switches. The DIP switches must be pressed and must never be slid.

ON/OFF position of the rocker switches

The illustration shows the position of the rocker switches for the setting ON and OFF

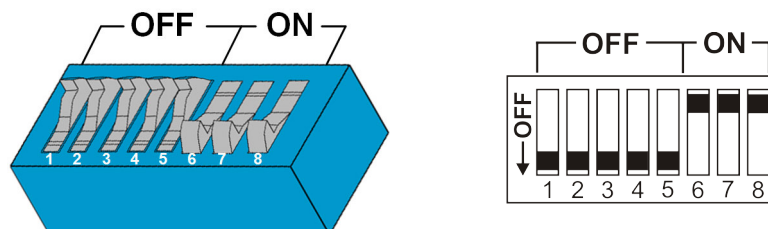

The DIP switches are located under the connection panel cover. The following figure shows only the affected DIP switches, others are not shown. The following setting must be made on the DIP switch DSW2:

Activation of communication - DSW2.5

Function	Figure
Activation of communication	

Information

Changes to the DIP switch settings only become effective after a restart of the charging station!

To restart, press the "Service button" until the first beep (approx. 1 second) or switch off the charging station for a short time via the line circuit breaker.

3.3 Configuration via web interface

The necessary settings (main menu "Configuration") for the communication of the charging station are configured in the web interface. The configuration for the entire charging network is done via the master charging station.

A network connection is required to access the web interface of the master charging station. The network connection can be made via LAN, WLAN, WLAN access point or GSM (e.g. with PC or mobile device).

The web interface of the master charging station can be accessed by entering the IP address of the master charging station in a web browser.

The IP address of the master charging station is determined differently depending on the connection type.

WLAN access point	The IP address of the WLAN access point is printed on the configuration label.
Router with integrated DHCP server	The charging station automatically receives an IP address via the DHCP server of the router. The IP address is displayed on the charging station display when the charging station is (re)started. The IP address can also be determined via the router.
Master charging station with local DHCP server	<p>The local DHCP server has been activated for the master charging station, which automatically gives the master charging station the following IP address: 192.168.42.1</p> <p>The DHCP server of the charging station is deactivated in the delivery state and can be activated via the configuration in the web interface.</p>

A login is required to use the web interface.

The login data for the first login in the web interface is printed on the configuration label. The configuration label is in a pouch which is enclosed with the mounting material. For security reasons, change the password after the initial login.

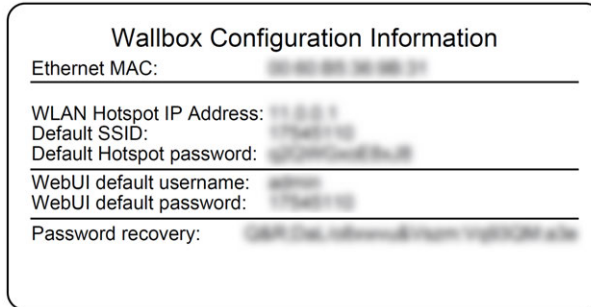

Fig. 3-5: Configuration label

After successful login, the start page of the web interface opens.

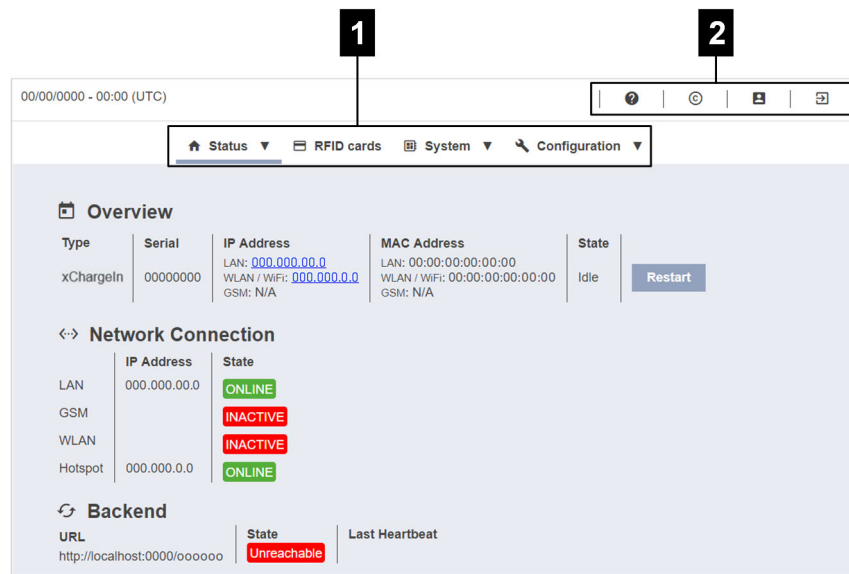

Fig. 3-6: Web interface start page



The following chapters provide an overview of the possibilities of the web interface. A detailed description of the individual configuration options can be found directly next to the respective configuration entry.

3.3.1 Main menu

The main menu is divided into the following areas:

- Status
- RFID cards
- System
- Configuration

Status

This page is divided into the following sections:

Overview

Basic information about all charging stations in the charging network (such as: serial number, IP address, operating state ...) is displayed here. Next to each listed charging station there is a "Restart" button to restart the charging station.

By clicking on the respective IP address, a new browser window displays charge information, such as total power, charge session power, power, voltage, current, state, and event log. The scope of the displayed information is variant-dependent.

Network Connection

Information about the network interfaces (LAN, GSM, WLAN and WLAN access point) of the master charging station is displayed here.

Backend

Information about the OCPP backend (such as connection state and address) is displayed here.

RFID cards

This page provides an overview of all stored RFID cards including their authorizations. RFID cards can be taught-in, edited and deleted. RFID cards can also be exported and imported as *.CSV file.

System

The area offers the following options:

- Software-Update
- GSM Info
- WLAN Access Point Info
- Logging
- DSW settings
- Restart System

Software-Update

The currently installed software versions are displayed. A software update can also be performed here.

GSM Info

Information about the GSM connection is displayed and the connection to the set GSM network can be tested.

WLAN Access Point Info

The state of the WLAN access point (hotspot) is displayed.

Logging

Different event logs of the master charging station are displayed.

DSW settings

The DIP switch settings of each charging station in the charging network can be displayed here.

Restart System

The master charging station can be restarted using this button.

Configuration

The configuration of the charging station is carried out in this area.

Information

The DIP switch settings are independent of the web interface configuration and cannot be overwritten by software.

The area offers the following options:

- Operating Mode
- Device
- Phase Assignment
- Charging Parameters
- Network Connection
- Certificates
- WLAN / WiFi Access Point
- Proxy
- OCPP
- External TCP Meter
- Display Text

Information

The settings made are only applied after the "Apply" button has been pressed.

Operating Mode

Here you can determine whether the charging station is operated as a single charging station or as a master charging station in a charging network.

The number of slaves must be entered for a charging network. In addition, all attached slave charging stations must be entered with their respective serial numbers. Otherwise, the slave charging station will not be recognized by the master charging station in the network. The serial number is printed on the rating plate of the slave charging station.

Both the master charging station and all attached slave charging stations can be enabled ("available") or disabled ("out of service") individually. If the charging station is disabled during a charging process, the charging process will be stopped. When the charging station is disabled, the LED bar slowly flashes orange and the display shows that the charging station is out of operation.

Device

The basic settings for the charging station are configured here: Managing the authorization function; synchronizing the time of the charging station with the time of the browser (after time synchronization the charging station is restarted); enabling and disabling the USB stick features.

Phase Assignment

The connection type (1-phase or 3-phase) of the charging station is selected here. With 1-phase connection, the core of the supply line used can also be selected. For a charging network, the connection type of the slave charging stations is also selected here.

Charging Parameters

The nominal supply voltage of the charging station is selected here. The current limits for the charging network can also be set here.

Network Connection

The network communication can be selected and configured here.

Certificates

Certificates in *.pfx format can be imported for an encrypted connection. The connection to the web interface, to the OCPP backend and to the charging station can be encrypted. The following certificates are available:

Certificate	Encrypted connection to ...	Required key
Https WebUI	Web interface	Private key
OCPP Server	OCPP backend	Private key
OCPP Client	Charging station	Public key

WLAN / WiFi Access Point

The WLAN access point can be configured here and enabled or disabled as required.

Proxy

All the necessary configurations for using a proxy server can be found in this part.

OCPP

All the necessary configurations for connecting to an OCPP backend can be found in this part.

External TCP Meter

Here you can set whether the charging station can read out the measured values from external meters for dynamically adjusting the charging current. All the necessary configurations for the external meter can be found in this part. This menu is only available if the charging station is operated as a single charging station (not available on charging network).

Display Text

Settings for the text can be made here, which is shown on the display and describes various operations of the charging station. The language of the text can be changed, the display duration can be set and the displayed text itself can be changed.

The display text is limited to 20 characters, no special characters or umlauts can be used.

3.3.2 User menu

The user menu contains important information and settings for the user. It is divided into the following areas:

- Help
- Licenses
- User Settings
- Logout

User Settings

This section allows you to make changes to the following user settings:

Username and Password

The web interface user name and associated password can be changed here.

Remote Service Interface

The remote access to the charging station can be activated here. This allows a service technician to access the charging station via an encrypted connection. This setting can also be made at the OCPP backend.

Log Level

For error diagnosis, it may be necessary to record the operations of the charging station in detail. The DEBUG mode can be activated in this area for this purpose. To prevent the recorded data volume from becoming too large, the duration for the detailed recording must also be specified.

Recovery Key

If you have forgotten the web interface password, you can reset it with the displayed recovery key. The recovery key can also be found on the configuration label.

Information

The recovery key must be kept safe for the entire life of the product!

3.4 Enabling the DHCP server

To simplify the setup of a charging network, the master charging station can be configured as a DHCP server. This function is required for the network configuration when the master and one slave are connected directly or when a network connection is implemented via switch.

The DHCP server of the master charging station is deactivated in the delivery state and can be activated via the configuration in the web interface.

3.5 Configuration in series via USB stick

Several xChargeIn M Series can be configured with the same settings. For this purpose, the configuration of one xChargeIn M Series is saved on a USB stick and then transferred to other xChargeIn M Series.

Preparation

The following tools are required for the configuration via USB stick:

- An empty USB stick that is formatted to FAT32
- A computer

Furthermore, the settings that allow the configuration to be read out and imported must be enabled in the web interface of the charging station (under Configuration > Device):

- "Allow USB init": Allows the configuration to be read out. This setting must be activated on the charging station that provides the configuration.
- "Allow USB config": Allows the configuration to be imported. This setting must be activated on the charging station to which the configuration is transferred.

Required steps

The following steps are required in order to transfer the configuration of one xChargeIn M Series to additional xChargeIn M Series:

- Create configuration
- Read out configuration
- Adapt configuration file
- Import configuration

3.5.1 Create configuration

If this has not yet been done, a first xChargeIn M Series must be configured with the desired settings. These settings serve as the basis for the configuration of additional xChargeIn M Series.

The easiest way to configure the charging station is via the web interface. On the graphical user interface the available settings and selection fields are provided with short explanations.

Information

Not all settings available in the web interface can be transferred via USB stick to additional charging stations.

3.5.2 Read out configuration

In order to be able to transfer the configuration of one xChargeIn M Series to additional xChargeIn M Series, the USB stick must be connected to the USB interface (in the connection panel) of the operationally ready and already configured charging station. The charging station automatically transfers the configuration to the USB stick and displays the process on the display. When finished, the charging station indicates that the USB stick can be removed by displaying "remove usb".

Information

Do not remove the USB stick during the writing process! Otherwise it cannot be used for another configuration.

3.5.3 Adapt configuration file

To adapt the configuration file, the USB stick must be connected to a computer. The configuration file was saved on the USB stick in the directory `CFG` as `*.conf` file. In order to use the file to configure other charging stations, the file name and parts of the content must be adapted.

Adapt file name

The file name contains the serial number of the charging station from which the configuration was read out. This serial number must be deleted from the file name.

A configuration file without a serial number in the file name can be used to configure multiple charging stations. If the configuration is to be valid for only exactly one charging station, the file name must contain the serial number of the desired charging station.

Adapt content

The specific configurations that only apply to one charging station must be adapted or deleted in the configuration file.

All settings are listed in the configuration file. The figure below shows a section of a configuration file. To the left of the equal sign "=" is the name of the setting. To the right of the equal sign is the set value.

```
[CONFIGURATION]
ChargeBoxIdentity=ChargingStation
AuthorizationEnabled=true
SetSecureIncomingConnection=false
SetSecureOutgoingConnection=false
HostConnectorType=OCPP_15
CentralSystemAddress=localhost
CentralSystemPort=7000
CentralSystemPath=mockCentralSystemServiceSoap
ChargepointAddress=localhost
ChargepointPort=12801
AmountConnectors=2
LogLevelDebug=false
Connect2ConnectorSerial1=11111111
Connect2ConnectorSerial2=22222222

[LOADMANAGEMENT]
MaxAvailableCurrent=100000
NominalVoltage=230
PwmMinCurrentDefault=6000
...
```

Fig. 3-7: Section of a configuration file

To adapt and delete the specific configurations, proceed as follows:

- 1) Open the configuration file with a text editor.
- 2) Adapt the following entries:
 - ▶ AmountConnectors=[x]
The number of charging stations in the charging network must be adapted here.
- 3) Delete the following entries completely:
 - ▶ ChargeBoxIdentity=[xxx]
 - ▶ Connect2ConnectorSerial [x]=[xxx]
 - ▶ HOTSPOT_SSID=[xxx]
 - ▶ HOTSPOT_KEY=[xxx]
- 4) Save the file.

Information

By deleting all `Connect2ConnectorSerial` entries, the charging station automatically searches for other charging stations in the charging network. As many charging stations are searched as specified under `AmountConnectors`.

Adapt configuration (optional)

If necessary, the configuration can be adapted manually. Each of the listed settings can be adapted by editing the value to the right of the equal sign "=".

Example of a possible adaptation of the configuration

Initial configuration	Adapted configuration
AuthorizationEnabled= true	AuthorizationEnabled= false

Information

Invalid settings will not be applied.

3.5.4 Import configuration

To load the configuration into another xChargeIn M Series, the USB stick must be plugged in to the desired charging station. The configuration will be imported automatically and adopted after a restart.

4 Functions

The following chapters describe special functions of the charging station.

4.1 Load management in the local charging network

Load management in a local charging network allows multiple xChargeIn charging stations to operate on a common supply. The maximum power allowed by the supply line is divided by the master charging station.

Information

Charging at a slave charging station is only possible if there is a connection to the master charging station. This prevents overloading of the connection.

4.1.1 Equal allocation mode

If the parallel active charging stations in a local charging network request more power than the power supply provides (set maximum current), the available charging current is divided evenly across all charging sessions.

Charging current per charging station = set maximum current per phase / number of active charging sessions on this phase

If insufficient power is available for an additional charging process in the charging network (set minimum current is underrun), the new charging process will be lined up. Every 15 minutes, an active charging session is paused in sequence, lined up at the back of the line, and the next charging session in the line continues.

4.1.2 Current limiting

The current limiting for the charging station can be regulated in various ways.

- Setting by means of DIP switches locally on each charging station
- Specification by master charging station
- Specification via UDP connection
- Reading out an external meter using Modbus TCP

If a current limit is specified via several different types, then the lowest preset value is used for the currently valid current limit.

4.2 RFID authorization

Certain device variants are equipped with an RFID reader, which enables the authorization of a charging process with RFID cards in accordance with ISO 14443 and ISO 15693. The RFID authorization only allows a charging session to be started if an identification takes place by means of an RFID card. The authorization function is activated and deactivated in the web interface of the master charging station.

In the case of a local charging network without a higher-level OCPP backend, all RFID cards must be taught in at the master charging station. Up to 1000 RFID cards can be stored. After teaching in, the permitted RFID cards are stored on the master charging station and are managed by the latter throughout the charging network. It is not possible to teach in RFID cards at a slave charging station.

When connecting to an external OCPP backend, all RFID cards must be taught in at the OCPP backend. Any number of RFID cards can be stored. It is not possible to teach in the RFID card directly at a charging station.

4.2.1 Authorization modes

Once the authorization function is activated in the web interface, 3 authorization modes are available. These determine which source is used first to retrieve the stored RFID cards. Depending on the authorization mode, the charging station will behave differently if the connection to the OCPP backend fails.

Mode	Behavior in the standard case	Behavior in case of connection failure
FirstLocal	The authorization request is first checked against the RFID cards stored locally on the charging station. If the RFID card is not stored locally and an OCPP backend is used, it is checked against the RFID cards stored on the OCPP backend.	The authorization request is checked against the RFID cards stored locally on the charging station. ^{*)}
FirstOnline	The authorization request is always checked against the RFID cards stored on the OCPP backend. No check is made with the RFID cards stored locally on the charging station.	The authorization request is checked against the RFID cards stored locally on the charging station. ^{*)}
OfflineNo Authorization	The authorization request is always checked against the RFID cards stored on the OCPP backend. No check is made with the RFID cards stored locally on the charging station.	The RFID card is read and the charging process is always enabled. As soon as the connection to the OCPP backend is established again, the RFID card is checked and the charging process is aborted if an invalid RFID card is used.

Information
If no OCPP backend is used, the "FirstLocal" authorization mode must be set for authorization to be active.

*) The first 1000 RFID cards are relayed from the OCPP backend to the master charging station where they are stored locally. If the connection to the higher-level OCPP backend fails, the master charging station authorizes these stored RFID cards throughout the network until the connection is reestablished.

4.2.2 Displays and signals

During RFID authorization, the charging station can display different light patterns on the LED bar and emit acoustic signals.

LED bar

Display	Description
Flashing green (every 3 seconds)	Authorization is done correctly.
Flashing blue (every 3 seconds)	The charging station is waiting for authorization to enable a charging process. Authorization necessary, either with RFID card or by an external input.
Illuminated orange (once)	The RFID card is invalid.

Acoustic signals

Signal	Description
Single tone	RFID card has been read.
Rising tone sequence	RFID card has been accepted.
Falling tone sequence	RFID card has been rejected (no authorization).

The charging station can also display a text concerning the RFID authorization, e.g. "accepted card". This text can be customized via the web interface.

4.2.3 RFID authorization without OCPP backend connection

The following options are available for managing RFID cards:

- At the RFID reader of the charging station
- In the web interface

Managing RFID cards at the RFID reader

Both the master RFID card and all slave RFID cards can be taught in directly at the RFID reader of the charging station. To teach in an RFID card, no charging session may be active and no vehicle may be plugged into the charging station.

Teaching in a master RFID card

To access the "Service button", the housing cover and the connection panel cover must be removed.

- 1) Press and hold the "Service button" in the connection panel until the second signal tone is sounded (approx. 10s).
The charging station will then automatically perform a restart, deleting all previously taught-in RFID cards, if necessary.
- 2) The charging station will be available again after 30 seconds.
- 3) After the waiting time, the first three segments of the led bar are illuminated. A master RFID card can be taught in for 30 seconds by holding it in front of the RFID reader.
A successful teach-in process is confirmed by a rising tone sequence.

Teaching in a slave RFID card

- 1) Hold the master RFID card in front of the RFID reader and wait for the rising tone sequence.
- 2) Then hold the slave RFID card to be programmed in front of the RFID reader within 10 seconds and wait for the signal tone.
- 3) Confirm the teach-in process by holding up the master RFID card again within 5 seconds.
A successful teach-in process is confirmed by a rising tone sequence.

Managing RFID cards in the web interface

RFID cards can be managed via the configuration in the web interface. The following functions are available:

- Teaching-in, editing or deleting an RFID card
- Exporting or importing a list of stored RFID cards as *.csv file

Information

*It is recommended to use a text editor for editing the *.csv file. Otherwise the date can be interpreted incorrectly upon import.*

The following entries can be made during teaching-in and editing of an RFID card:

Entry	Description
RFID Card – Serial No. (UID)	Serial number (UID) of the RFID card. This can be read out with a suitable mobile phone app, for example.
Expiry Date	Date up to which the RFID card is to be valid.
Master RFID Card	Set the RFID card as master RFID card. Only one card can be defined as master RFID card.
Status	Authorization of the RFID card. Here it is also possible to block an RFID card and thus prevent charging with the relevant RFID card.
Charging Station – Serial No.	Serial number of the charging station where the RFID card may be authorized. All or only certain charging stations in the charging network can be enabled for the RFID card.

4.2.4 RFID authorization with OCPP backend connection

If the charging station or a charging network is controlled by an OCPP backend, please note the following:

- Teach in RFID cards:
All RFID cards must be "centrally taught in" at the OCPP backend.
- "Authorization" in the web interface to "ON":
Each authorization request is relayed to the OCPP backend.
- "Authorization" in the web interface to "OFF":
A charging process can only be started without holding up an RFID card if the predefined token set in the configuration is recognized and accepted by the OCPP backend.

Information

For information on the functionality and the required settings of the OCPP backend, refer to the specific manual of the system used.

4.2.5 Start charging process with RFID authorization

To start a charging process with RFID authorization, proceed as follows:

- 1) Plug the vehicle into the charging station.
- 2) Hold the RFID card, which was previously taught in, in front of the RFID reader.
- 3) The rising tone sequence and the green flashing LED bar indicate that the RFID card has been accepted.
The charging process can now be started by the vehicle.
- 4) If necessary, the charging process can be stopped prematurely by holding the same RFID card in front of the RFID reader again.

Information*Enable input X1*

For special device variants, the enabling of a charging session can also be controlled via the enable input X1 (for connecting external components such as a timer, photovoltaic system or home control). If this function has been activated in the DIP switch settings, enabling a charging session will additionally require a correct signal on the enable input X1. Further information can be found in the "Installation Manual".

4.3 OCPP backend

The charging station offers the option of being connected to a central management system via the Open Charge Point Protocol (OCPP). OCPP, as an open application protocol, makes it possible to connect any central management system to the charging station regardless of the manufacturer or supplier.

When connecting to an OCPP backend, note the following:

- It is recommended that the master charging station on the network be assigned a static IP address based on the MAC address of the device.
- Since the OCPP backend is usually not in the same network, the charging station must be assigned a "public IP address" which is routed to the internal IP address (NAT).
- The firewall must be configured so that a communication between the charging station and the OCPP backend is possible.
- For a connection via VPN, the IP address of the VPN must be specified in the configuration (web interface) for the downlink.
- In the case of a GSM connection, it may be necessary for the required ports to be activated by the cellular service provider.

Ports for communication via OCPP

For communication with an OCPP backend, the following ports must be enabled in the network:

Port	Protocol	Definition	Description
Custom (1025 - 65535)	TCP	Can be reached externally (incoming)	<p>OCPP Charge Point Service: This service is related to the OCPP backend.</p> <ul style="list-style-type: none"> The port can be freely selected or it is specified by the OCPP backend. However, the port may only be located in the range from 1025 to 65535. The selected port must be configured on the charging station.
Custom	TCP	Access to external (outgoing)	Port at which the OCPP backend can be reached.
123	UDP	Incoming and outgoing	Port for the timer server of the charging station.

4.4 UDP interface

The charging station offers the possibility of passing information and receiving commands via the User Datagram Protocol (UDP). This can be used, for example, for integration into a Smart Home. For more information, see the "UDP Programming Guide", which is available in the download area on the Eaton website.

4.5 Integration of external meters

The charging station can read the measured values from external meters using Modbus TCP. This allows an intelligent calculation of the charging current provided to the vehicle, and the charging process is optimized. The measured values read are included in the charging current specification. The following graphic shows the schematic structure of the system.

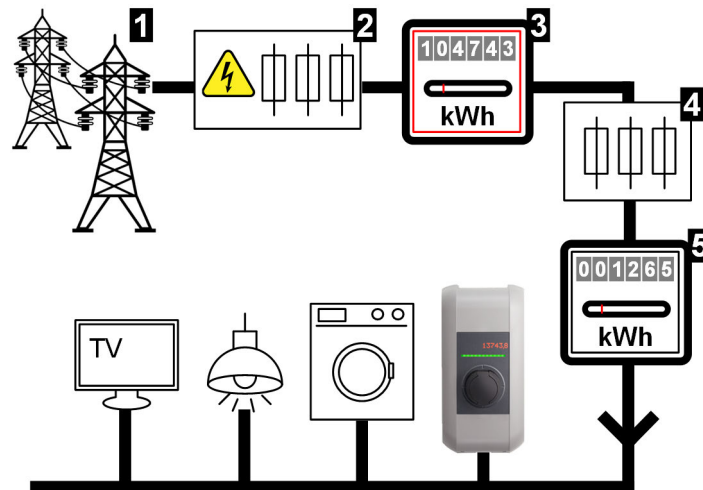

Fig. 4-8: Modbus TCP system overview

1 ... Public power grid	2 ... Pre-meter fuse (high-capacity fuse, line circuit breaker, ...)
3 ... Electricity meter of the network operator	4 ... Post-meter fuse
5 ... External meter (house connection meter)	

Information

The illustration provides an exemplary system overview and does not include all the necessary ancillary equipment required for safe operation of the equipment (e.g. line circuit breaker, residual-current device ...).

Domestic Connection Monitoring

By means of the domestic connection monitoring, the charging vehicle can be dynamically provided with the respective available charging current, depending on the remaining consumers on the house connection. This ensures that the domestic connection safety device is not overloaded, and that it is not always necessary to select a lower charging capacity than would be possible with the vehicle and the installation.

Via the meter **5**, the charging station can read out the entire current energy supply from the power grid. Based on this information and the value of the post-meter fuse **4** (maximum charging current, which is specified by the post-meter fuse) defined by DIP switches, the charging station can regulate the charging current in such a way that the maximum energy reference never exceeds the value of the post-meter fuse value.

4.5.1 Connection

When connecting external meters please note the following:

- The connection is made via the Ethernet1 connection X4 (LSA+®). For this, the meter must be in the same network as the charging station.
- The meter must be connected with the same phase sequence as the charging station, so that the house load calculation and the charging optimization are carried out correctly. If it is necessary to connect the charging station beginning with phase 2 in order to better distribute the phase loads, the meter must also be connected beginning with phase 2.

4.5.2 Supported meters

The following meters can be read out by the charging station using a **Janitza ProData 2 data logger**.

Manufacturer	Model
ABB	B23 312-100
B-control	EM300
Herholdt	ECSEM113
Janitza	B23 312-10J
Janitza	ECSEM114MID
Siemens	7KT1260

The following meters can be read out directly by the charging station using Modbus TCP.

Manufacturer	Model
B-control	EM300 LR
B-control	EM300 LRW

Information

Detailed information about the meter installation can be found in the installation instructions of the meter manufacturer.

4.5.3 Settings





The Modbus TCP feature is disabled by default. If an external meter with a Modbus TCP network interface was installed in the system, it must be configured in the web interface in advance.

Setting the current of the post-meter fuse

The post-meter fuse is designed for a certain current level. In order to calculate the charging current, the current of the post-meter fuse must be set via the DIP switches in the connection panel of the charging station. If no external meter is found when the Modbus TCP function is activated, the charging current is reduced to 10 A.

The setting must be made on the DIP switch DSW1. The following DIP switches can only set a maximum value that is less than or equal to the current of the post-meter fuse.

DSW1.4 to DSW1.5

Current	Figure
25 A	
35 A	
50 A	
63 A	

Information

Changes to the DIP switch settings only become effective after a restart of the charging station!

To restart, press the "Service button" until the first signal tone sounds (approx. 1 second) or switch off the charging station for a short time via the line circuit breaker.

5 Maintenance

5.1 Diagnosis and troubleshooting

The FAQs on the Eaton website help to rectify possible errors that might occur:

<http://www.eaton.com/evc>

5.2 Software update

It is recommended to always keep the charging station up-to-date, as it contains functional enhancements and bug fixes. A software update is available on the Eaton website:

<http://www.eaton.com/evc>

The information and instructions for the current software update from the associated release notes must also be observed.

A software update may only be performed if no vehicle is plugged in at the charging station.

Information

The software update can take up to an hour. The update process is indicated by a slow orange flashing of the LED bar.

After the software update, the charging station restarts automatically. The LED bar will flash blue or green, depending on the authorization setting.

Information

The power supply must not be interrupted during the software update. Otherwise, the software update is not terminated correctly and further normal operation of the charging station is no longer guaranteed.

Software update at charging network

A software update for a charging network must be performed at the master charging station (xChargeIn M Series). The master charging station relays the new firmware to the connected slave charging stations (S Series) via the software update.

5.2.1 Software update via web interface

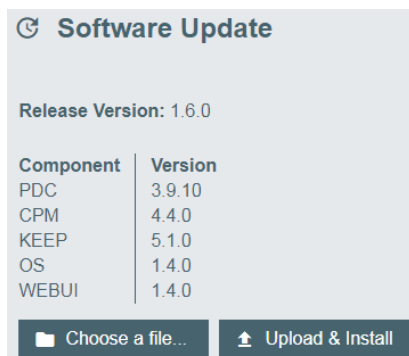

Fig. 5-9: Web interface software update

To perform a software update via the web interface, proceed as follows:

- 1) Download the current software for the charging station (*.keb file).
- 2) Log into the web interface of the charging station.
- 3) In the main menu under "System" select the item "Software Update".
- 4) Upload the current software using the "Choose a file ..." button.
- 5) Start the update process with the "Upload & Install" button.

5.2.2 Software update via USB stick

For a software update via USB stick, this feature must be activated in the configuration (web interface).

To perform a software update via a USB stick, proceed as follows:

- 1) Download the current software for the charging station (*.keb file).
- 2) Plug the USB stick into a PC.
- 3) Format the USB stick with FAT32.
- 4) Create a new directory on the USB stick with the name "UPD".
- 5) Copy the downloaded *.keb file into the "UPD" directory.
- 6) Connect the USB stick to the USB interface of the charging station. The update starts automatically.

5.2.3 Software update via OCPP backend

The software update for the entire charging network can be performed via the OCPP backend.

To perform the software update an FTP link is required. The information downloaded from the Eaton website along with the software update contains the FTP link.

For details on using the FTP link, see the OCPP backend manual.

Index

C

Charging network	13
Direct connection	14
Load management.....	28
Ports for communication	15
Router	14
Software update.....	38
Switch	14

Configuration

DHCP server.....	24
DIP switch.....	16
USB stick	24
Web interface.....	17

Configuration in series..... 24

Current limiting

D

DHCP server	24
DIP switch	16

E

Equal allocation mode	28
External meters	34
Connection.....	36
Domestic Connection Monitoring.....	35
Settings.....	37
Supported meters	36

G

GSM	12
-----------	----

L

LAN	10
Load management	28

M

Master charging station	13
Modbus TCP	34

N

Network interfaces.....	9
-------------------------	---

O

OCPP backend.....	33
Ports for communication	34

R

RFID authorization	29
Acoustic signals	30
Connection failure	29
LED bar.....	30
OCPP backend	32
RFID card	30
Start charging process	32
Router.....	14

S

Slave charging station	13
Software update	38
Switch.....	14

U

UDP interface	34
USB stick	24

W

Web interface	17
WLAN	11
WLAN Access Point (Hotspot)	12