



XLR-16R2507B-R
XLR-18R0507B-R

Contents

INTRODUCTION **3**

SAFETY **3**

THEORY OF OPERATION **3**

INSTALLATION **4**

OPERATION **6**

OVERVOLTAGE SIGNAL **6**

TEMPERATURE MONITORING **7**

MAINTENANCE **8**

STORAGE **8**

DISPOSAL **8**

Introduction

The XLR-LV modules are self-contained energy storage device comprised of six individual supercapacitor cells. The module includes bus bar connections, integrated cell voltage management circuitry, an overvoltage alarm and a thermistor for measuring internal temperature of the cells. Units may be connected in series to obtain higher operating voltage (maximum 150 V from ground), in parallel to provide higher current, high power or longer run time, or a combination of series/parallel arrangements, as needed. The module is designed to withstand rugged operating environments with high vibrations and liquid present.

The module is designed to provide pulse power with frequent discharges in vehicles, transportation, heavy equipment or grid applications. The module can be cooled with forced air when frequent, high current charges or discharges occur.

The cell voltage management system provides the highest reliability for optimizing product lifetime by providing cell voltage balancing and a cell overvoltage alarm.

Please refer to the datasheet for detailed specifications. This manual covers the following part numbers and high level specifications.

Part number	Rated voltage	Rated capacitance
XLR-16R2507B-R	16.2 V	500 F
XLR-18R0507B-R	18.0 V	500 F

Safety

The XLR-LV module contains stored energy up to 22.5 watt-hours and can discharge up to 10600 amps if short circuited. Only personnel trained in high power electrical systems should work on such systems. Modules are typically connected in series to increase the operating voltage and potential discharge current. Before working on a system with modules installed, the module(s) should be discharged and the voltage on each module verified prior to conducting any work.



WARNING

Danger High Voltage Hazard

Never touch the power terminals as the module may be charged and cause fatal electrical shocks. Always check that the module is fully discharged before manipulating the module.

For more information about the discharge procedure, please refer to page 8.

- Do not operate the XLR-LV above the rated voltage.
- Do not operate unit above specified temperature rating.
- Do not touch terminals with conductors while charged.

Serious burns, shock, or material fusing may occur.

- Protect surrounding electrical components from incidental contact.
- Provide sufficient electrical isolation when working above 50 Vdc.
- Prior to installation or removal from the equipment, it is **mandatory** to fully discharge the module.

Theory of operation

Supercapacitors function on electrostatic principles with no chemical reactions and no moving parts. They avoid the lifetime issues associated with chemical storage of batteries or mechanical issues associated with fly wheels. The XLR modules are non-toxic and designed for years of maintenance-free operation.

Supercapacitors are intended as energy storage with a DC discharge. The module should not be used for AC charging or discharging. Discharges may be constant current or constant power. Example discharges are shown in Figure 1a and 1b. The voltage of the module drops linearly under a constant current discharge.

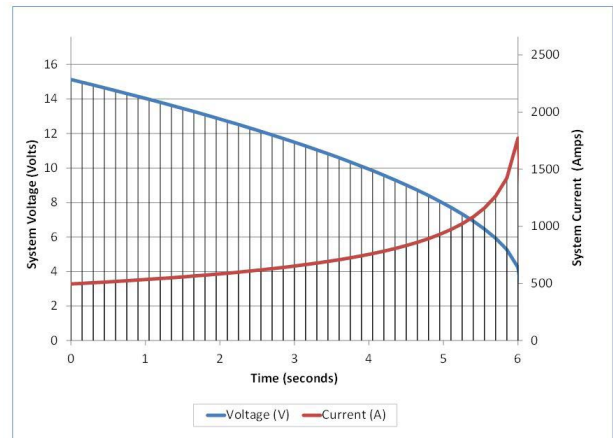

Figure 1a. Example voltage and current discharge curve for 7.5 kW discharge from one module with 16 V float voltage

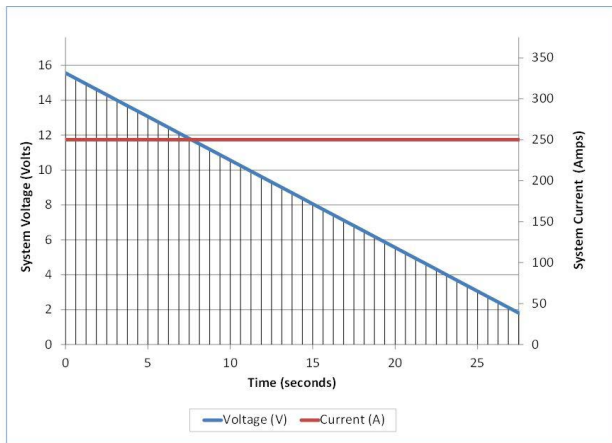

Figure 1b. Example voltage and current discharge curve for 250 A discharge from one module with 16 V float voltage

Due to the very low equivalent series resistance (ESR) of the supercapacitors, minimal heat is generated during operation. However, as supercapacitors can handle very high currents, a significant heat rise can occur if the discharges and re-charging is frequent and above 125 A_{RMS} continuous current.

Most systems require multiple modules connected in series to reach higher operating voltages. The XLR-LV module can be series connected for operation up to 150 V (with respect to ground) to meet system level requirements and connected in parallel without limit to meet longer discharge times.

Due to manufacturing variations in capacitance and leakage current, cells in a module can differ in voltage. This voltage difference affects the capacitance and equivalent series resistance over time and results in a shortening of the life of the system. The shunt balance circuit monitors the voltage of each cell. When the voltage on a cell exceeds 2.65 V preset in the XLR-LV, the balancing circuit will activate to discharge the cell back to appropriate levels.

Installation

Unpacking

Inspect the shipping carton for signs of damage prior to unpacking the module. Damage to the shipping carton or module should be reported to the carrier immediately.

Remove the module from the shipping carton and retain the shipping materials until the unit has been inspected and is determined to be operational.

NOTE: The original shipping materials are approved for both air and ground shipment. The module should be removed from the shipping carton by lifting it by the body of the module.

Contents:

- 1 Module
- 1 M10 bolt, washer, lock washer (inserted into negative terminal)
- 1 M8 bolt, washer, lock washer (Inserted into positive terminal)

- 1 Communications mating connector wired (installed on communications connector)

If the unit is found to be defective or any parts are missing, contact your local sales representative. A Return Material Authorization (RMA) number must be issued prior to returning the unit for repair or replacement.

Mechanical

The XLR-LV module is ideally intended for an upright installation as shown in Figure 2, however it can be mounted in any orientation. Regardless of the orientation, the module should be secured to a surface using the four mounting holes shown Figure 3. See the respective data sheets for more information on mounting locations. ([click here](#)).

The module has 4 M8 mounting holes, as shown in Figure 2 and 3. A spacer may be needed between the top and bottom plate in high vibration environments. In moderate or low vibration environments, only the holes on the top or bottom plate are required for securing the module. For more severe applications, when using the top and bottom mounting holes, a spacer may be inserted between the top and bottom plate to add additional support.

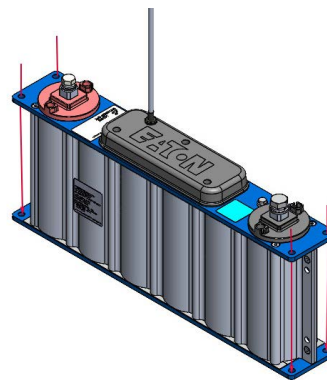

Figure 2: Mounting points for the module

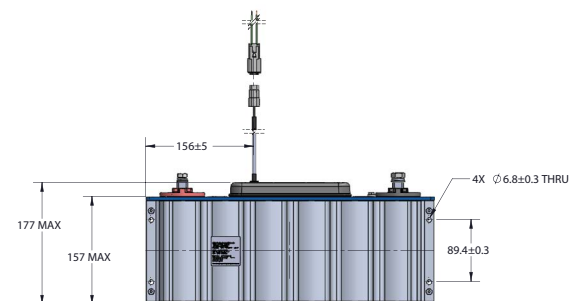
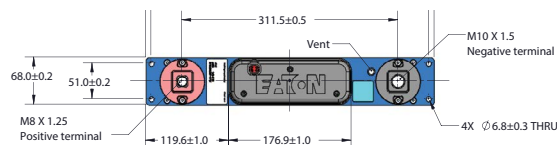

Figure 3: Dimensional drawing of the module; all dimensions are in mm.

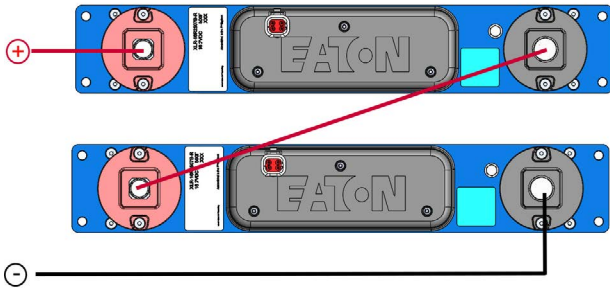

Figure 4: Series connected modules (top view). In this example, the system could provide 10 kW for 10 seconds at 32 V maximum voltage when using the XLR-LV modules.

Electrical

CAUTION

To avoid arcing and sparking the energy storage module should be in a discharged state and the system power disconnected during installation. The module is shipped discharged and with a shorting wire. The shorting wire should be removed prior to electrical connection.

CAUTION

To provide the lowest possible ESR the energy storage modules are not fused. Care should be taken within the application to prevent excessive current flow as required. Excessive current and/or duty cycle will result in overheating the module which will cause accelerated degradation. Please consult the specific data sheet for each module for current and duty cycle capabilities.

Output terminal posts

The output terminals of the module consist of threaded aluminum, female posts. They are designed to connect directly to a ring lug or a bus bar. Apply a layer of high conductivity aluminum-aluminum anti-oxidant joint compound between the mating surfaces. The positive terminal is a threaded M8 female thread and the negative terminal is M10 female threaded. The maximum stack height of the lugs, bus bars and lock washers should be 0.6" (15 mm). The maximum depth of the threaded terminal is 20 mm. When applying torque to the terminals, it is recommended to use a maximum torque of 20 N-m / 14.8 ft-lbs.

Attachment to the output terminals should be made with ring lugs or bus bars of an appropriate size for the application current and the M8/M10 terminal size. The energy storage modules have low ESR. As a result, the resistance of the cable connecting the energy storage module to the load can easily exceed the ESR of the module.

Connection of modules in series or parallel or combination thereof should utilize the same gauge wire (or equivalent bus bar) as determined for final output connections. When connecting in series, connect the positive output terminal of one module to the negative output terminal of the next module (as shown in Figure 4 and Figure 6). For parallel connections, connect positive terminals together and negative terminals together (as shown in Figure 5).

making parallel connections, it is recommended to make the connections at the load to ensure that the resistance across all strings is the same. It is not recommended to use the module terminals as a parallel connection point. The maximum operating voltage of a series connected system should not exceed 150 V to meet UL requirements..

All cables connected to the module should have a strain relief to avoid damage to the module terminals in high vibration environments. The cables should be secured to avoid free movement and vibrations on the terminals. This includes the monitoring cable.

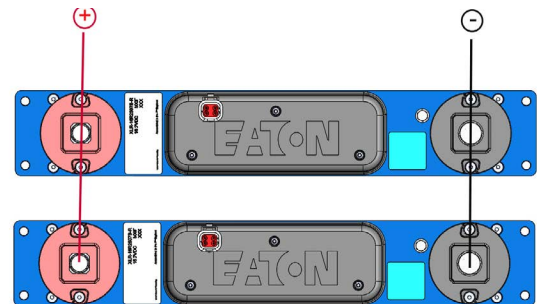

Figure 5: Parallel connected modules (top view). In this example, the system could provide 8 kW for 13 seconds at 16 V maximum voltage when using the XLR-LV modules.

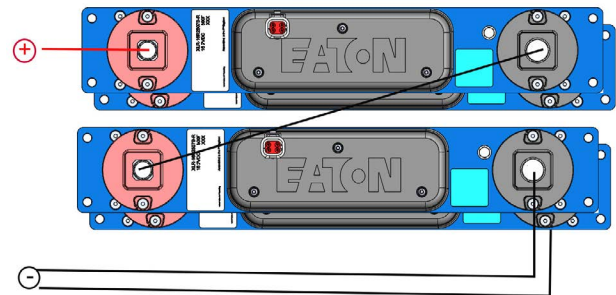

Figure 6: 2 series x 2 parallel connected modules. In this example, the system would provide 10 kW for 22 seconds at 32 V maximum voltage when using the XLR-LV modules. Recommended connection point for the parallel strings is at the load or a common terminal block, not on a module terminal.

Module-to-module balancing

The modules are equipped with voltage management circuitry that reduces the voltage on cells which exceed the rated voltage. The voltage management functions over hours to minimize the standby current requirements. Module-to-module balancing is not required as the balancing system works on each individual cell.

Thermal performance

Low internal resistance of the energy storage modules enables low heat generation within the modules during use. As with any electronic component, the cooler the part operates the longer the service life. In most applications natural air convection should provide adequate cooling. In severe applications requiring maximum service life, forced airflow may be required.

The thermal resistance, R_{th} , of the units has been experimentally determined assuming free convection at ambient (~ +25 °C). The R_{th} value provided on the data sheet is useful for determining the operating limits for the units. Using the R_{th} value a module temperature rise can be determined based upon any current and duty cycle. The temperature rise can be expressed by the following equation.

$$\Delta T = I^2 R_{esr} R_{th} d_f$$

where:

- I = current RMS AC or DC (amps)
- R_{esr} = equivalent series resistance of the supercapacitor (ohms)
- R_{th} = thermal resistance (°C/W)
- d_f = duty cycle fraction

This ΔT plus ambient should remain below the specified maximum operating temperature for the module (please refer to the module datasheet).

Operation

General

The module should only be operated within specified voltage and temperature ratings. Determine whether current limiting is necessary on input/output based on current ratings of ancillary devices. Observe polarity indicated on module. Reverse polarity operation of the module(s) is not allowed for modules. Reverse polarity operation of the module will result in damage to the balancing circuitry.

Electric isolation of the module is tested to 2500 V for maximum series operating voltage of 750 Vdc.

When several modules are connected in series for operating at higher voltage, care must be taken to ensure proper creepage and clearance distances in compliance with national safety standards for electrical equipment. However, UL rating is to a maximum operating voltage of 150 V.

Monitoring connector

A 4-pin connector (Deutsch DTM06-4S, mating connector DTM04-4P) is provided to monitor overvoltage conditions of cells and cell temperature. These provide warning indicators

that a problem may exist in the module or can be monitored for extreme conditions. The connector should not be left to freely move. This will cause vibrations to damage the connector or wires to the connector. Secure the connector to the module, rack or cabinet. The pin definition is as follows:

Table 1: Monitoring connector pinout

Pin #	Signal name	Output	Maximum current	Color
1	GND			Black
2	Overvoltage	High: not active Low: active	5 mA	White
3	Not used			
4	Temperature	See table		Green

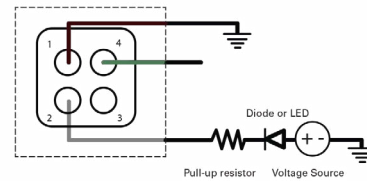

Figure 8. Monitor connector (Deutsch DTM06-4S). Outside the dotted line is a recommended implementation from the system.

Overvoltage signal

An electrically isolated open collector logic output is made available for alarm interface. When the voltage exceeds a fixed voltage on any cell in the XLR-LV module, a signal will be triggered at alarm connector J1 present on module. When several modules are connected in series, parallel or series-parallel combination, the alarm logic output signal can be monitored individually or can be setup in a wire OR configuration to form a single fault signal from the string. It is recommended that each module be monitored individually to provide the greatest diagnostic capability in the field.

Below table shows pin out indication of the connector, and maximum current allowed. 5.0 Vdc can be the maximum open circuit voltage across connector provided.

Overvoltage signal operation

1. Overvoltage Pin 2 goes active (closes the circuit to ground) if any cell inside module exceeds overvoltage limit.
2. Since Pin 2 (overvoltage signal) is an open collector transistor output, pull-up resistor (~1K) connected to a 5 V supply should be connected to Pin 2, as shown in Figure 9.
3. When a simple pull up circuit is built around Pin 2, Pin 2 will remain ~5 V when there is no overvoltage which indicates normal operating condition. When the cell goes into over-voltage condition, Pin 2 goes low. This alarming signal can be used to signal system electronics to abort charging of module and to permit overcharged cells to appropriately discharge down to set limits, through a built-in active balancer
4. The internal overvoltage circuit can sink up to 5 mA with an output signal low voltage of no more than 0.7 V. When there is no over voltage signal, maximum leakage current through pull up resistor is 100 nA. Based on the overall electronic system, proper value of the pull-up resistor should be selected.

Temperature monitoring

A thermistor is attached to a cell inside the module. This allows monitoring of the internal module temperature. The temperature can be monitored with a high impedance, constant current circuit and measuring the voltage.

The resistance vs. temperature is shown in Table 2. The temperature can be monitored with a high impedance, constant current circuit and measuring the voltage.

Table 2: Temperature monitoring

T (°C)	T (°F)	Resistance (kΩ)	T (°C)	T (°F)	Resistance (kΩ)	T (°C)	T (°F)	Resistance (kΩ)	T (°C)	T (°F)	Resistance (kΩ)
-40	-40.0	348.4	0	32.0	32.78	40	104.0	5.324	80	176.0	1.260
-39	-38.2	325.5	1	33.8	31.14	41	105.8	5.114	81	177.8	1.220
-38	-36.4	304.3	2	35.6	29.6	42	107.6	4.915	82	179.6	1.181
-37	-34.6	284.7	3	37.4	28.14	43	109.4	4.724	83	181.4	1.144
-36	-32.8	266.4	4	39.2	26.76	44	111.2	4.541	84	183.2	1.109
-35	-31.0	249.4	5	41.0	25.46	45	113.0	4.367	85	185.0	1.074
-34	-29.2	233.7	6	42.8	24.23	46	114.8	4.200	86	186.8	1.041
-33	-27.4	219.0	7	44.6	23.07	47	116.6	4.040	87	188.6	1.009
-32	-25.6	205.4	8	46.4	21.96	48	118.4	3.887	88	190.4	0.9785
-31	-23.8	192.7	9	48.2	20.92	49	120.2	3.741	89	192.2	0.9488
-30	-22.0	180.8	10	50.0	19.94	50	122.0	3.601	90	194.0	0.9201
-29	-20.2	169.8	11	51.8	19.00	51	123.8	3.468	91	195.8	0.8924
-28	-18.4	159.5	12	53.6	18.12	52	125.6	3.339	92	197.6	0.8657
-27	-16.6	149.9	13	55.4	17.28	53	127.4	3.339	93	199.4	0.8400
-26	-14.8	141.0	14	57.2	16.48	54	129.2	3.099	94	201.2	0.8151
-25	-13.0	132.6	15	59.0	15.73	55	131.0	2.986	95	203.0	0.7911
-24	-11.2	124.8	16	60.8	15.01	56	132.8	2.878	96	204.8	0.7679
-23	-9.4	117.5	17	62.6	14.33	57	134.6	2.775	97	206.6	0.7455
-22	-7.6	110.7	18	64.4	13.69	58	136.4	2.675	98	208.4	0.7239
-21	-5.8	104.3	19	66.2	13.08	59	138.2	2.580	99	210.2	0.7030
-20	-4.0	98.33	20	68.0	12.50	60	140.0	2.489	100	212.0	0.6828
-19	-2.2	92.74	21	69.8	11.95	61	141.8	2.401	101	213.8	0.6633
-18	-0.4	87.50	22	71.6	11.42	62	143.6	2.317	102	215.6	0.6444
-17	1.4	82.59	23	73.4	10.92	63	145.4	2.237	103	217.4	0.6262
-16	3.2	77.98	24	75.2	10.45	64	147.2	2.159	104	219.2	0.6086
-15	5.0	73.66	25	77.0	10.00	65	149.0	2.085	105	221.0	0.5916
-14	6.8	69.61	26	78.8	9.572	66	150.8	2.013	106	222.8	0.5751
-13	8.6	65.81	27	80.6	9.164	67	152.6	1.945	107	224.6	0.5591
-12	10.4	62.24	28	82.4	8.776	68	154.4	1.879	108	226.4	0.5437
-11	12.2	58.88	29	84.2	8.406	69	156.2	1.815	109	228.2	0.5288
-10	14.0	55.73	30	86.0	8.054	70	158.0	1.755	110	230.0	0.5144
-9	15.8	52.76	31	87.8	7.719	71	159.8	1.696	111	231.8	0.5004
-8	17.6	49.97	32	89.6	7.400	72	161.6	1.640	112	233.6	0.4868
-7	19.4	47.35	33	91.4	7.095	73	163.4	1.586	113	235.4	0.4738
-6	21.2	44.88	34	93.2	6.805	74	165.2	1.534	114	237.2	0.4611
-5	23.0	42.55	35	95.0	6.528	75	167.0	1.483	115	239.0	0.4488
-4	24.8	40.36	36	96.8	6.265	76	168.8	1.435	116	240.8	0.4369
-3	26.6	38.29	37	98.6	6.013	77	170.6	1.389	117	242.6	0.4254
-2	28.4	36.35	38	100.4	5.772	78	172.4	1.344	118	244.4	0.4142
-1	30.2	34.51	39	102.2	5.543	79	174.2	1.301	119	246.2	0.4034
									120	248.0	0.3929

Maintenance

Prior to removal from the system, cable removal, or any other handling ensure that the energy storage module is completely discharged in a safe manner. The stored energy and the voltage levels may be lethal if mishandling occurs. Maintenance should only be conducted by trained personnel on discharged modules.

Discharge procedure

Proceed as follow to discharge the module:

1. Using a voltmeter, measure the voltage between the 2 terminals.
2. If the voltage is above 1 V, a resistor pack (not supplied with the module) will need to be connected between the terminals. Proper care needs to be taken in the design and construction of such a dissipative pack. e.g. At 16 V, for a 1 Ohm pack, the module will be discharged with a peak current of 23 A and will take about 16 minutes to discharge. The heat/power dissipated in the resistor pack will be ~ 370 W. The resistor pack will need to be sized and provided with suitable cooling to handle this power dissipation. Additionally, proper enclosure or other packaging is necessary to ensure safety. In all cases, proper design of the dissipative resistor pack is necessary.
3. If the voltage is under 1 V, connect a shorting wire to the + and – connectors.
4. The module is now safe for handling. The shorting wire should be connected at all times until the module is installed in the system and the power cables are connected

Routine maintenance

- If any dirt or grime, use a cleaning cloth dampened with a water/soap solution. Do not use high-pressure sprays or immersion
 - Frequency - Annually
- Check mounting fasteners for proper torque
 - Frequency – Annually
- Inspect housing for signs of damage
 - Frequency - Annually
- Check signal/ground connections
 - Frequency – Annually

Storage

The discharged module can be stored in the original package in a dry place. Discharge a used module prior to stock or shipment. A wire across the terminals should be used to maintain short circuit after having discharged the module.

Disposal

Do not dispose of module in the trash. Dispose of according to local regulations for general electronics waste.

Specifications

Please refer to respective datasheets.

Eaton
Electronics Division
1000 Eaton Boulevard
Cleveland, OH 44122
United States
Eaton.com/electronics

© 2023 Eaton
All Rights Reserved
Printed in USA
Publication no. ELX1333
June 2023

Eaton is a registered trademark.

All trademarks are property of their respective owners.