

Product Change Notice

PCN#: EE-PCN15011M

1/05/2018

(Supersedes PCN15011)

CLASSIFICATION OF CHANGE:

Shipping box and external and internal label update for Eaton Electronics Division products.

DESCRIPTION OF CHANGE:

Shipping boxes and labels are being converted from Cooper Bussmann logo to Eaton logo.

Amend: The format of the original Eaton labels has changed---Please see page 3 and 4 for a comparison of the new Eaton labels to the original Eaton labels.

Additional change: The "Lot Number" listed on the outer label is now the "Date Code" reference. Component marking change detail added (See page 5).

REASON FOR CHANGE:

Updating packaging and label requirements in accordance with corporate Eaton branding standards. Update to new marking standard.

EXPECTED INFLUENCE ON QUALITY, RELIABILITY, AND PERFORMANCE:

There will be no impact on the quality, reliability, or performance of any products inside of the packaging.

PART NUMBERS/ FAMILIES AFFECTED:

All Eaton Electronics Division products produced by ELXD own plants and manufacturing partners (Subcons). The specification excludes the label specifications agreed to with specific customers, and excludes package labels used on product purchased from other Eaton divisions.

TIME SCHEDULE:

Rolling change. Cut in date beginning week of July 5, 2018

Existing inventory of Cooper Bussmann branded boxes and labels will be used first. These boxes and labels are still valid and should not be returned.

Existing inventory of the original Eaton labels is valid and should not be returned.

ISSUED BY:

Global MarCom Manager: Sabrina Eastman

CONTACT INFORMATION:

For questions or comments, please contact your local [Eaton sales representative](#) or Sabrinaeastman@eaton.com

SHIPPING BOXES:

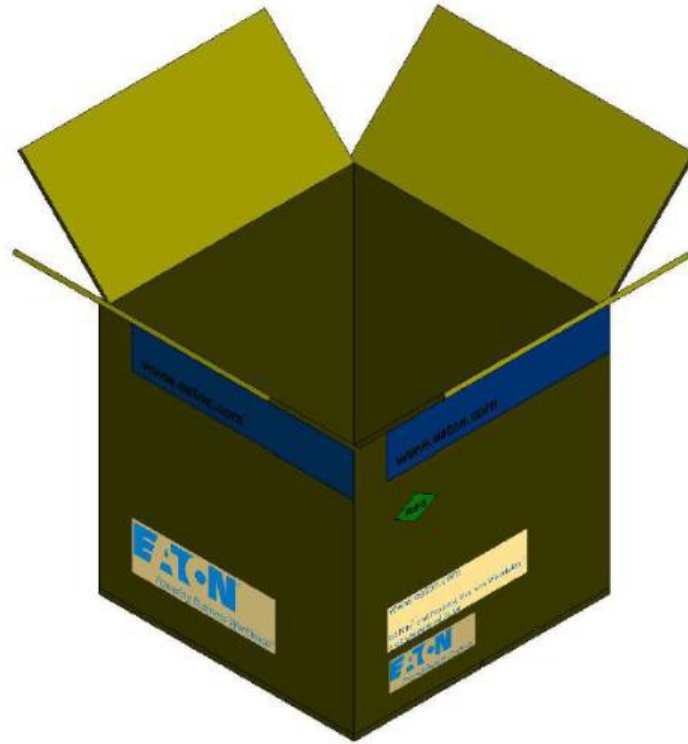

NEW-OUTER CARTON LABEL

(Please note labels shown are examples only and will apply to all Eaton Electronics Division magnetics, supercapacitor, circuit protection and terminal block product)

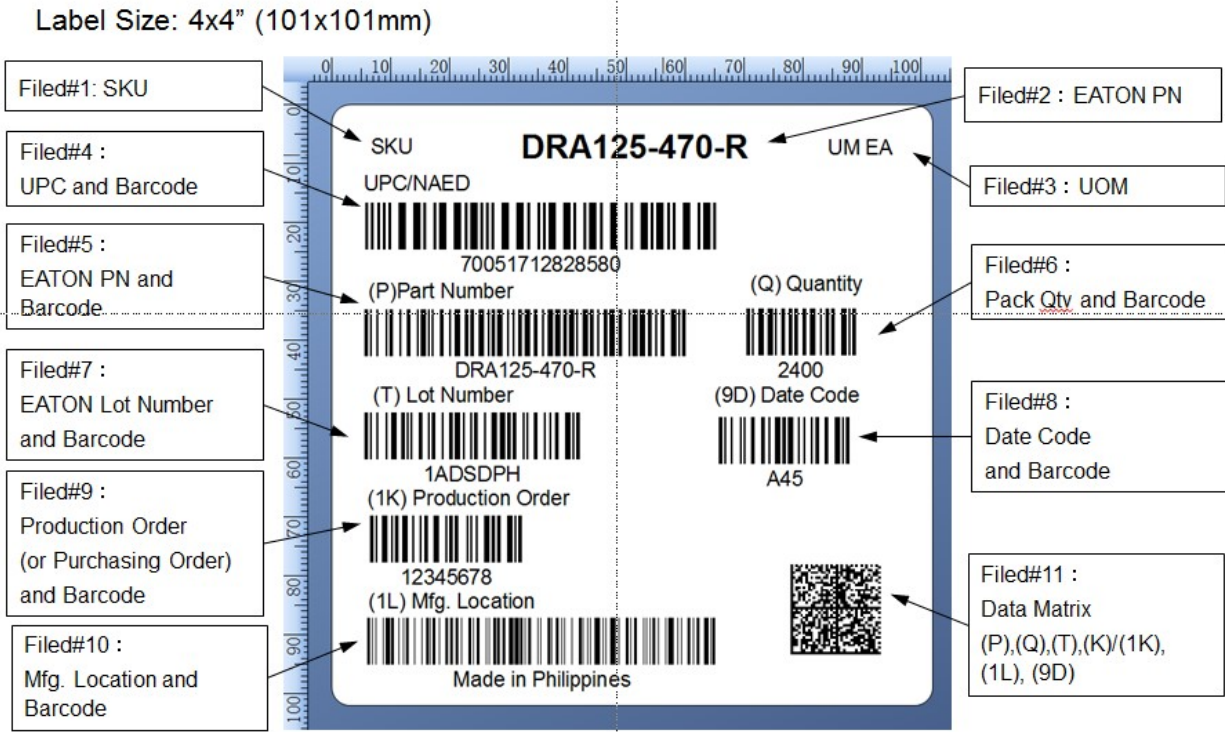

ORIGINAL---OUTER CARTON LABEL

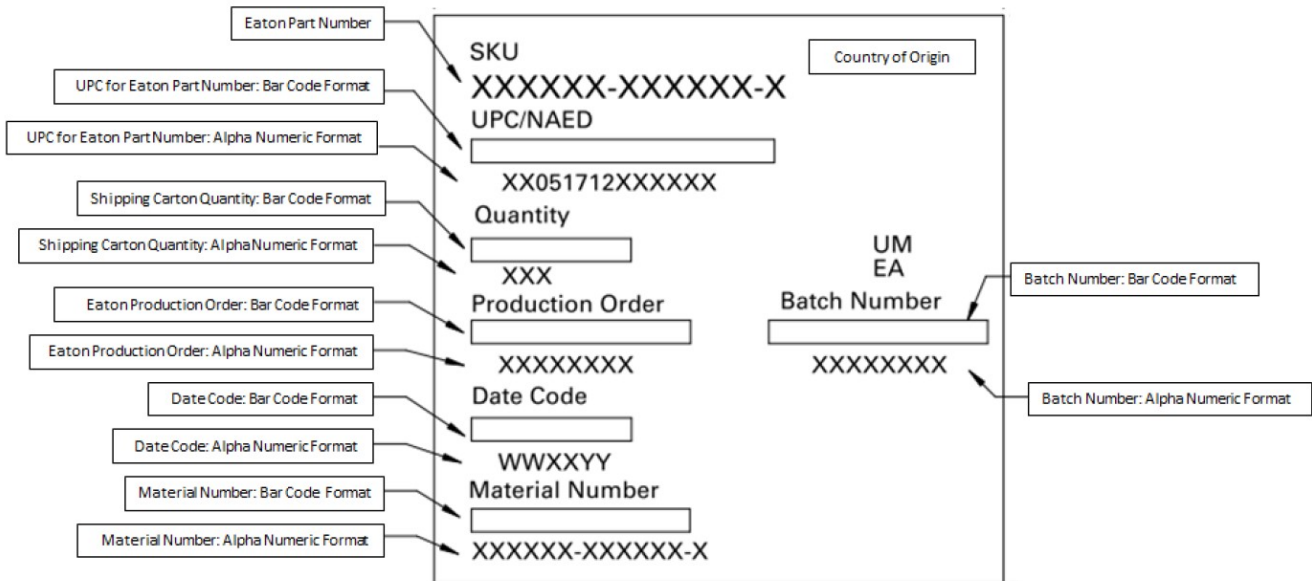

NEW---INNER CARTON LABEL

Label Size: 3x2" (76x51mm) preferred.
 Optional: 70x36mm, 66x37mm, or other sizes approved by ELXD.

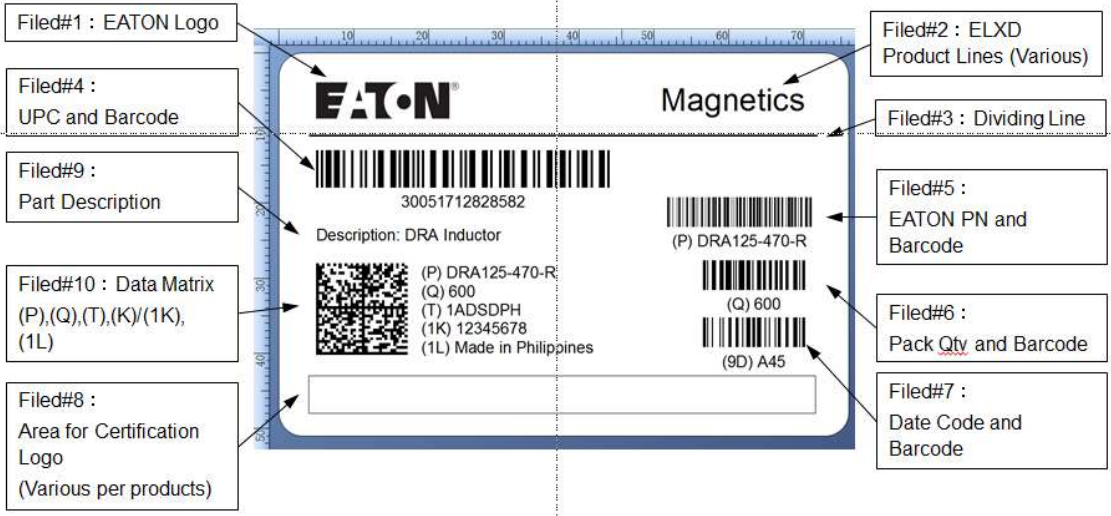

ORIGINAL---INNER CARTON LABEL 1

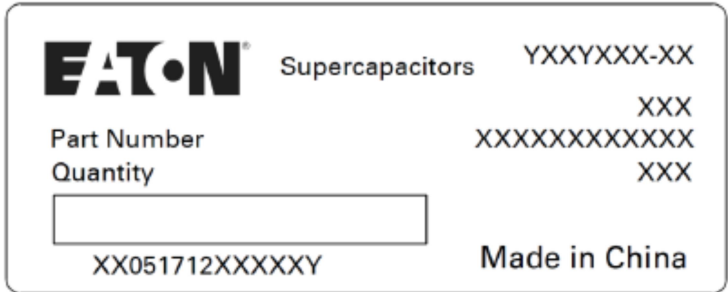

ORIGINAL---INNER CARTON LABEL 2



NEW-PART MARKING DETAIL

Eaton will be removing the existing date code formats from our product and be replacing the date code with a coded lot code. This is being done to improve traceability, unify format across product lines, and reduce the ability of counterfeit product be sold under the Eaton name. Below is a summary of the changes.

Circuit protection

No impact. Date code is not marked on circuit protection product.

Supercapacitor

Existing date code formats will be replaced with a 10 digit coded lot code: DDDDDLLXXX.

Magnetics

Existing date code formats will be replaced with an 7 digit coded lot code: DDDDDLL where space allows. See below for examples.

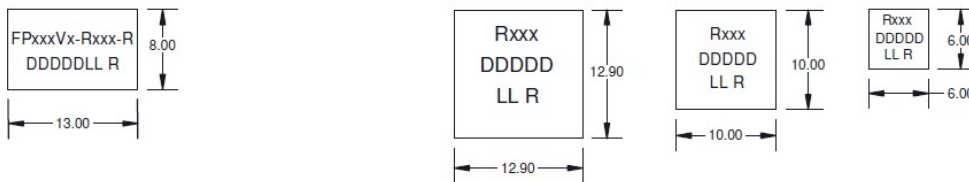

- Max(L or W) >= 13.0
 - FPxxxVx-Rxxx-R: specified Part Number defined for Finished Goods marking in the EPS.
 - DDDDDLL: Date Code
 - R=revision
- 6.0 <= Max(L or W) < 13.0
 - Rxxx: specified Part Number defined for Finished Goods marking in the EPS.
 - DDDDDLL: Date Code
 - R=revision

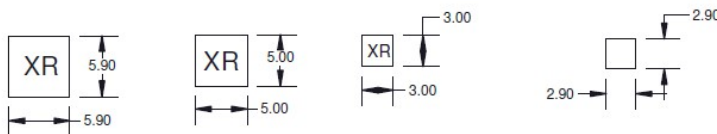

- 3.0 <= Max(L or W) < 6.0
 - X=Single Digits Part Number (A, B, C,...Z)
 - R=revision
 - No Date Code required
- Max(L or W) < 3.0
 - No Marking required