

EUC10

10 x 25 mm EV fuse



Product features

- 10 x 25 mm fuse
- Current rating: 30 A to 40 A
- 500 Vdc rating
- High breaking capacity for high energy applications
- Designed to JASO D622, ISO8820-8, GB/T31465
- Produced in a factory with ISO9001 & IATF16949 certification
- Minimum breaking capacity 300% In at rated DC voltage
- Bolt-down terminal

Applications

- Automotive and commercial vehicle on-board chargers
- Uninterruptible power supplies (UPS)
- 3-phase EVSE and charging infrastructure
- Motor protection
- Rectifiers and inverters
- Energy storage systems
- On-board electric vehicle powertrain and distribution

Environmental compliance



Ordering part number

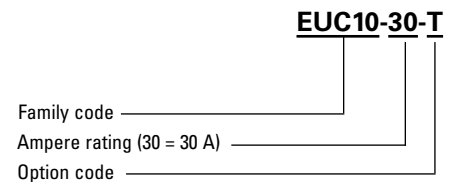

Option code

T= Bolt down terminal

Electrical characteristics

Amps (A)	Minimum (seconds)	Maximum (seconds)
2.0 I _n	1	100
3.0 I _n	0.1	15
5.0 I _n	0.05	1

Product specifications

Part number	Rated voltage	Rated current (A)	Breaking capacity	Typical cold resistance ¹ (mΩ)	Typical voltage drop (mV)	Power loss @ 0.5 I _n (W)
EUC10-30	500 Vdc	30	500 Vdc/20 kA	2.22	110	0.7
EUC10-40	500 Vdc	40	500 Vdc/20 kA	1.62	100	0.9

1. Cold resistance is measured at <10% I_n and +25 °C ambient temperature

Dimensions- mm

Tolerances unless otherwise specified

One place x.x = ± 0.3 mm

Two places x.xx = ± 0.13 mm

T: Bolt-down terminal

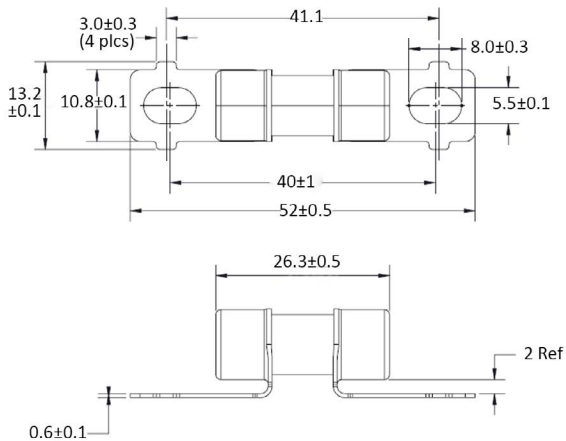

Part marking

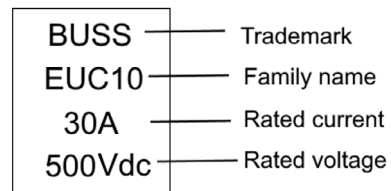

Note: recommended tightening torque is 4.5+/-1.0 Nm for M5 Screw

General specifications

Operating temperature: -40 °C to +125 °C with proper derating factor applied

Strength of terminals: JASO D622 6.3.9, mounting torque 4.5 +/-1 Nm, 3 times

Temperature humidity cycling: JASO D622 6.3.4.1,

- a) maintain the samples at standard conditions for 4 hours
 - b) increase T to 55 +/-2 °C at 95% to 99% RH within 0.5 hours
 - c) maintain T at 55 +/-2 °C at 95% to 99% RH for 10 hours
 - d) decrease T to -40 +/-2 °C within 2.5 hours; the humidity is uncontrolled
 - e) maintain T at -40 +/-2 °C for 2 hours; the humidity is uncontrolled
 - f) increase T to 120 +/-2 °C within 1.5 hours from -40 +/-2 °C; the humidity is uncontrolled
 - g) maintain T at 120 +/-2 °C for 2 hours; the humidity is uncontrolled
 - h) allow to return to RT within 1.5 hours; the humidity is uncontrolled 10 cycles.
-

Thermal shock: ISO8820-8 GB/T31465.6, 48 cycles; -40 °C to 100 °C, each cycle 60 minutes

Vibration: JASO D622 6.3.3, 10-55 Hz, 3 directions, 2 hours each direction

Transient current cycling: JASO D622 6.3.2 (reference), The transient current start from 2.0 In for 0.25 seconds, then drop to 0.5 In and keep this current to 15 seconds to finish one cycle, total 50000 cycles

Lubricant & fuel oil resistance: GB/T31465.1-5.4, Wipe the marking with lubricant or oil 30 seconds

Packaging information

Terminals	Inner package	Ship package
T	50 pieces/tray	500 pieces/box

Temperature derating curve

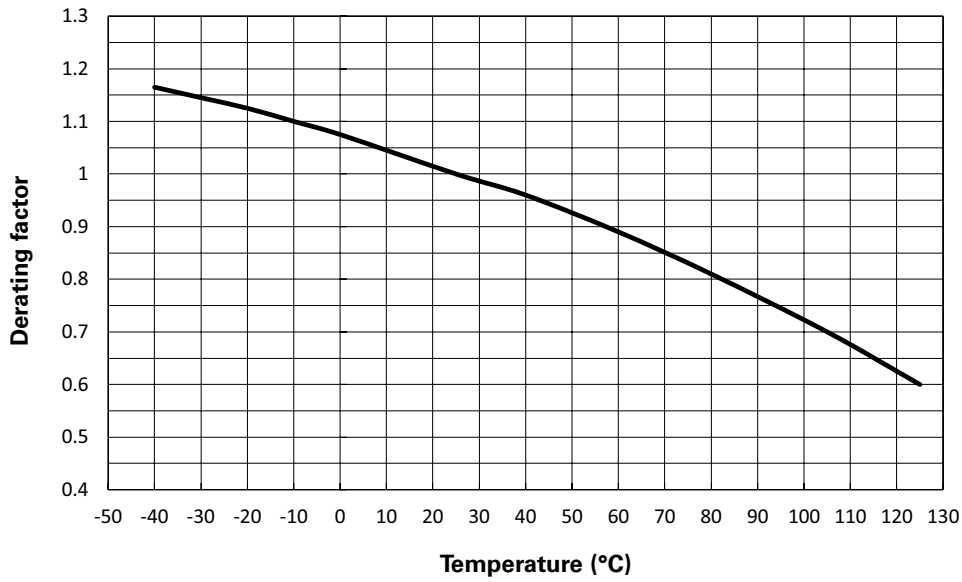

Current vs. time curve

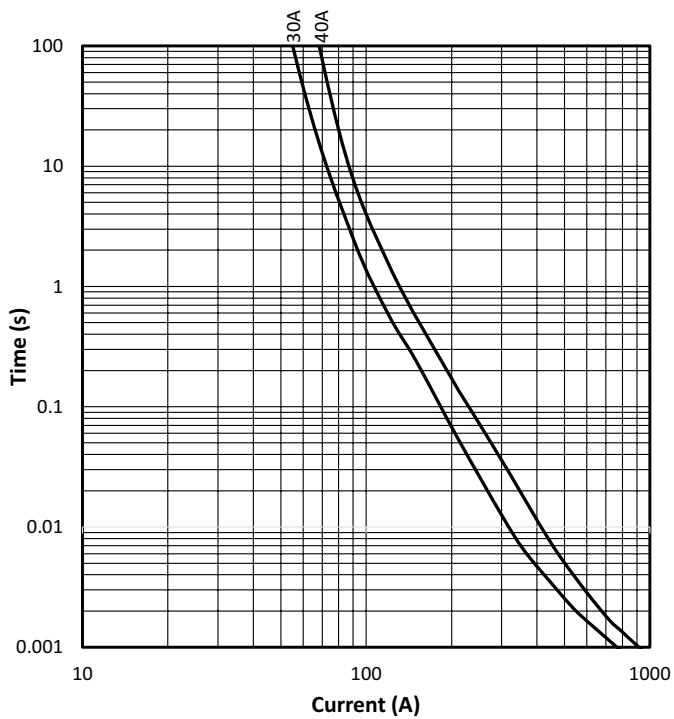

I²T vs. time curve

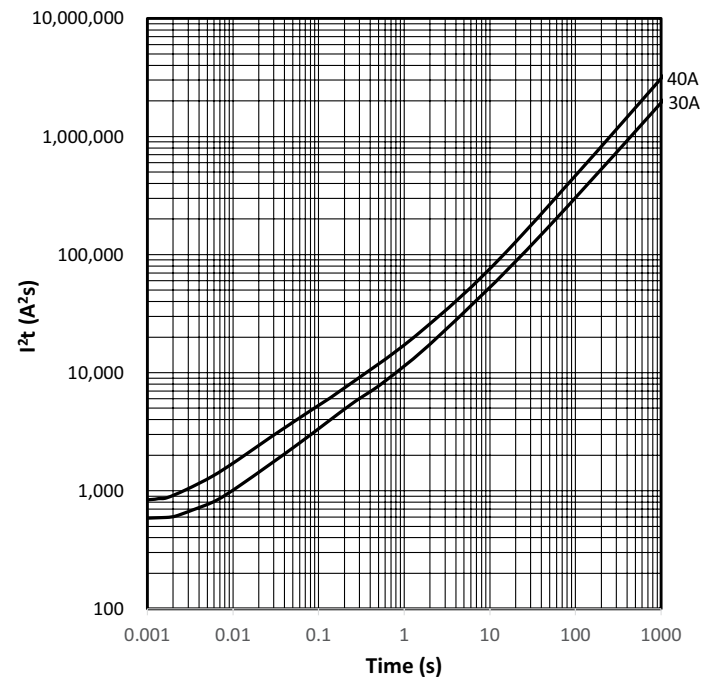

I²t vs. current curve

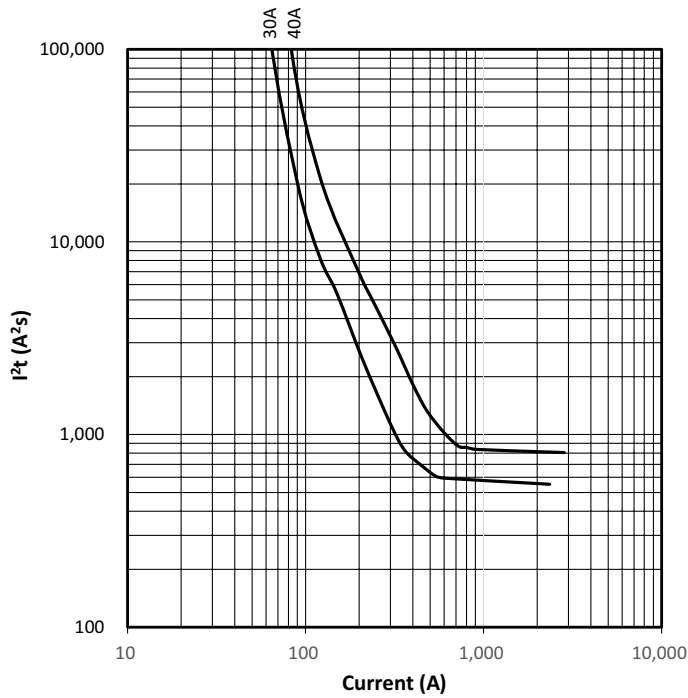

Life Support Policy: Eaton does not authorize the use of any of its products for use in life support devices or systems without the express written approval of an officer of the Company. Life support systems are devices which support or sustain life, and whose failure to perform, when properly used in accordance with instructions for use provided in the labeling, can be reasonably expected to result in significant injury to the user.

Eaton reserves the right, without notice, to change design or construction of any products and to discontinue or limit distribution of any products. Eaton also reserves the right to change or update, without notice, any technical information contained in this bulletin.

Eaton
Electronics Division
1000 Eaton Boulevard
Cleveland, OH 44122
United States
Eaton.com/electronics

© 2023 Eaton
All Rights Reserved
Printed in USA
Publication No. ELX1303 BU-ELX22166
May 2023

Eaton is a registered trademark.

All other trademarks are property of their respective owners.

Follow us on social media to get the latest product and support information.

