

Series C K-Frame

70-400A, 240-600V

Contents

Description	Page
Catalog Number Selection	4
Digitrip 310+ Electronic Trip Unit	
Types KD, CKD, HKD, CHKD	
Long Delay (LD) and Short Delay (SD) with Flat Response and Override (125A) (LSI, LSIG, ALSI, ALSIG)	TD012014EN 7
Long Delay (LD) and Short Delay (SD) with Flat Response and Override (250A, 400A) (LSI, LSIG, ALSI, ALSIG)	TD012007EN 8
Long Delay Response and Short Delay with I ² T Response Curve and Override (125A) (LS, LSG)	TD012015EN 9
Long Delay Response and Short Delay with I ² T Response Curve and Override (250A, 400A) (LSI, LSIG, ALSI, ALSIG)	TD012008EN 10
Types KDC (Current Limiting)	
Long Delay (LD) and Short Delay (SD) with Flat Response and Override (125A) (LSI, LSIG, ALSI, ALSIG)	TD012016EN 11
Long Delay (LD) and Short Delay (SD) with Flat Response and Override (240A, 400A) (LSI, LSIG, ALSI, ALSIG)	TD012012EN 12
Long Delay Response and Short Delay with I ² T Response Curve and Override (125A) (LS, LSG)	TD12017EN 13
Long Delay Response and Short Delay with I ² T Response Curve and Override (250A, 400A) (LS, LSG)	TD012013EN 14
Types KD, CKD, HKD, CHKD, and KDC (125A, 250A and 400A)	
Ground Fault Delay Response Curve (LSG, LSIG, ALSIG)	TD012009EN 15
Remote Maintenance Mode Setting (ALSI, ALSIG)	TD012010EN 16
KT Thermal/Magnetic Trip Unit	
Types KDB, KD, HKD	SC-4118-87B 17
Types KDC 2-, 3-, and 4-pole	SC-4119-87B 18
Let-through Curves	
FDC, JDC, KDC, and LDC—240V	AD-29-166A 19
FDC, JDC, KDC, and LDC—480V	AD-29-166B 20
FDC, JDC, KDC, and LDC—600V	AD-29-166C 21

Contents (continued)

Digitrip OPTIM 550/1050 Electronic Trip Unit for all K-Frame

	Page
Long Delay I ² T and Short Delay I ² T Response	SC-6924-98 22
Long Delay I ² T and Short Delay Flat Response	SC-6925-98 23
Long Delay I ⁴ T and Short Delay Flat Response	SC-6926-98 24
Instantaneous and Override, 125A Trip Unit	SC-6927-98 25
Instantaneous and Override, 250A Trip Unit	SC-6928-98 26
Instantaneous and Override, 400A Trip Unit	SC-6929-98 27
Ground Fault Trip or Ground Fault Alarm Only	SC-6930-98 28

Legacy Trip Unit Types

Earth Leakage Module Curves

UL Earth Leakage Curve ELFD, JD, and KD, three- and four-pole, 110-480V	TC01212005E 29
IEC Earth Leakage Curve ELFD, JD, and KD, three- and four-pole, 110-480V	TC01212006E 30

KES Digitrip RMS 310 Electronic Trip Unit

Types KDB, CKDB, HKDB, CHKDB, KD, CKD, HKD, CHKD	
Types KES3400LS, KES3400LSG	SC-5638-93 31
Types KES3400LSI, KES3400LSIG	SC-5639-93 32
Types KES3250LS, KES3250LSG	SC-5640-93 33
Types KES3250LSI, KES3250LSIG	SC-5641-93 34
Types KES3125LS, KES3125LSG	SC-5642-93 35
Types KES3125LSI, KES3125LSIG	SC-5643-93 36
Type KDC	
Types KES3400LS, KES3400LSG	SC-5644-93 37
Types KES3400LSI, KES3400LSIG	SC-5645-93 38
Types KES3250LS, KES3250LSG	SC-5646-93 39
Types KES3250LSI, KES3250LSIG	SC-5647-93 40
Types KES3125LS, KES3125LSG	SC-5648-93 41
Types KES3125LSI, KES3125LSIG	SC-5649-93 42
Types Ground Fault Protection	
Types KES3400LSG, KES3400LSIG	SC-5650-93 43
Types KES3250LSG, KES3250LSIG	SC-5651-93 44
Types KES3125LSG, KES3125LSIG	SC-5652-93 45

Type KS Electronic Trip Unit

Type KS (KS3400T, KS3400TG)	SC-4156-87A 46
---------------------------------------	--------------------------

Note:

Time/Current characteristic curves for Series C K-frame circuit breakers—voltages shown in curve headings are maximum at which the breaker may be applied. Interrupting capacity of individual breaker is tabulated on each curve.

Note:

The following curves are UL489 Listed for use in North America.
 The following circuit breakers are derived from Eaton, Westinghouse, or Cutler-Hammer history.

Time Current Curves are engineering reference documents for application and coordination purposes only. For field testing molded case circuit breakers, refer to NEMA AB 4 guidelines.

Catalog Number Selection

This information is presented only as an aid to understanding catalog numbers. It is not to be used to build catalog numbers for circuit breakers or trip units.

K-Frame with 310+ Electronic Trip Unit Technology

Table 1. 400A Frame Only

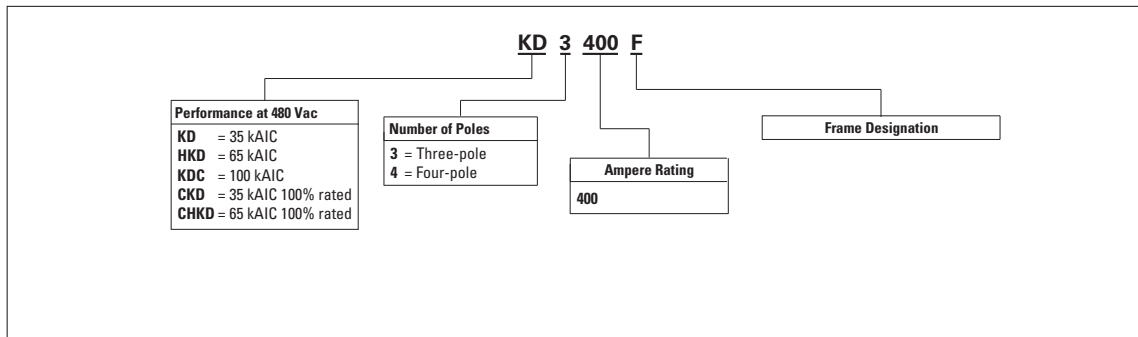

Table 2. 125/250/400A 310+ Electronic Trip Unit

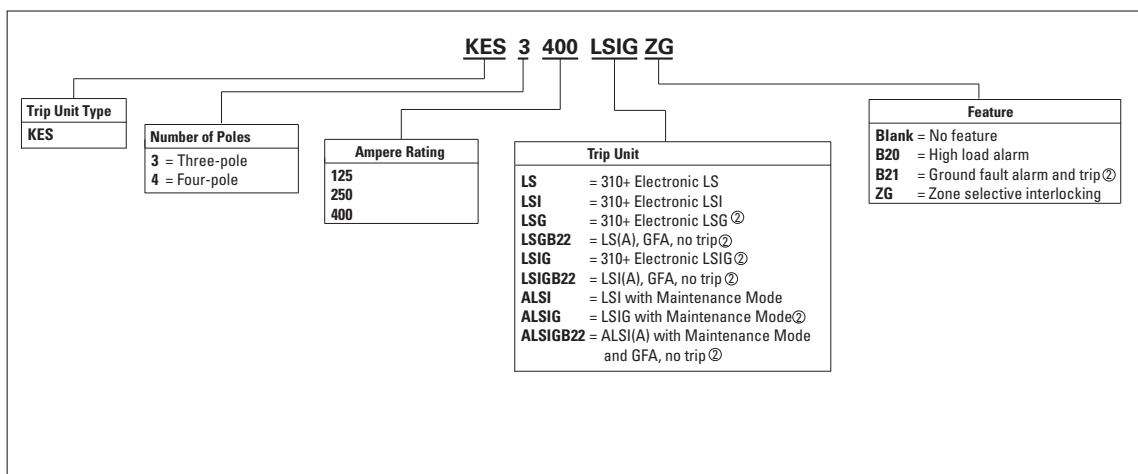
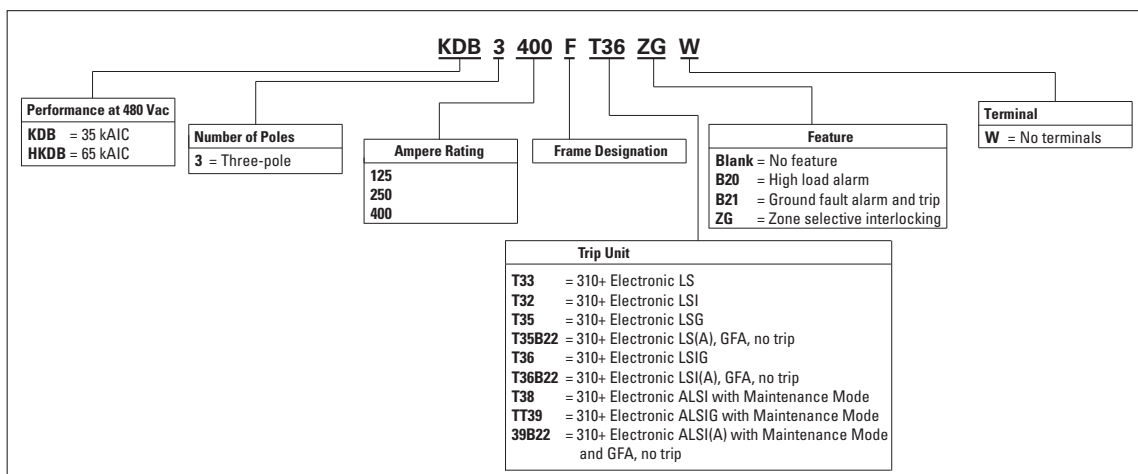

Table 3. 125/ 250/400A K-Frame 310+ Factory Assembled Breaker ②



Notes

- ① Only one B2x feature can be used
- ② Not available in four-pole configurations.

K-Frame with Thermal-Magnetic Trip Unit Technology

Table 4. Thermal-Magnetic Breaker/Frame

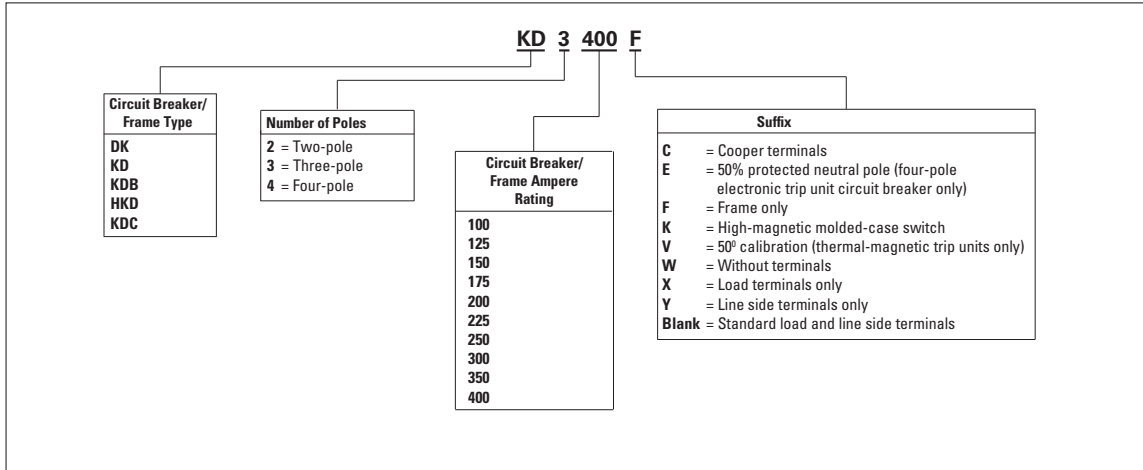
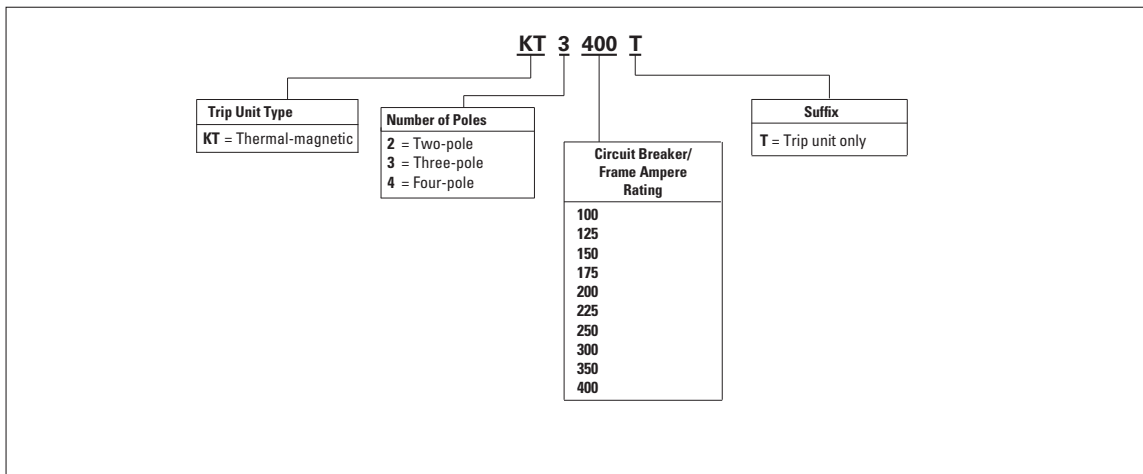
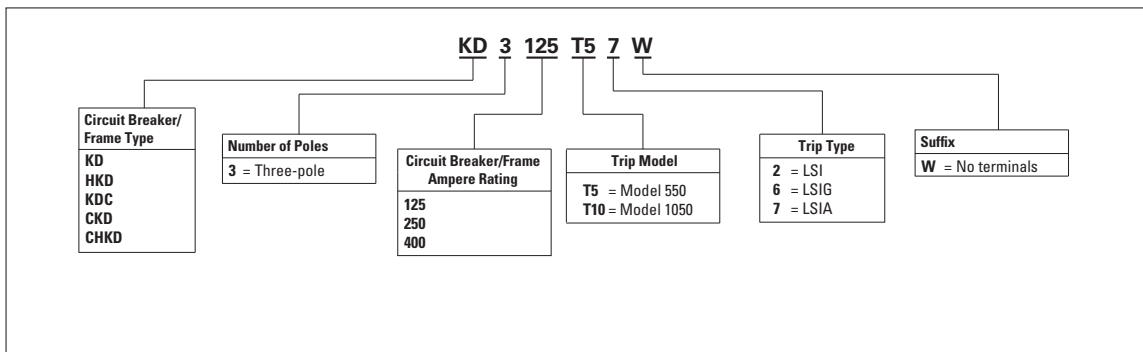

Table 5. Thermal-Magnetic Trip Unit



K-Frame with OPTIM 550/1050 Trip Unit Technology

Table 6. OPTIM 550/1050 Circuit Breaker/Frame



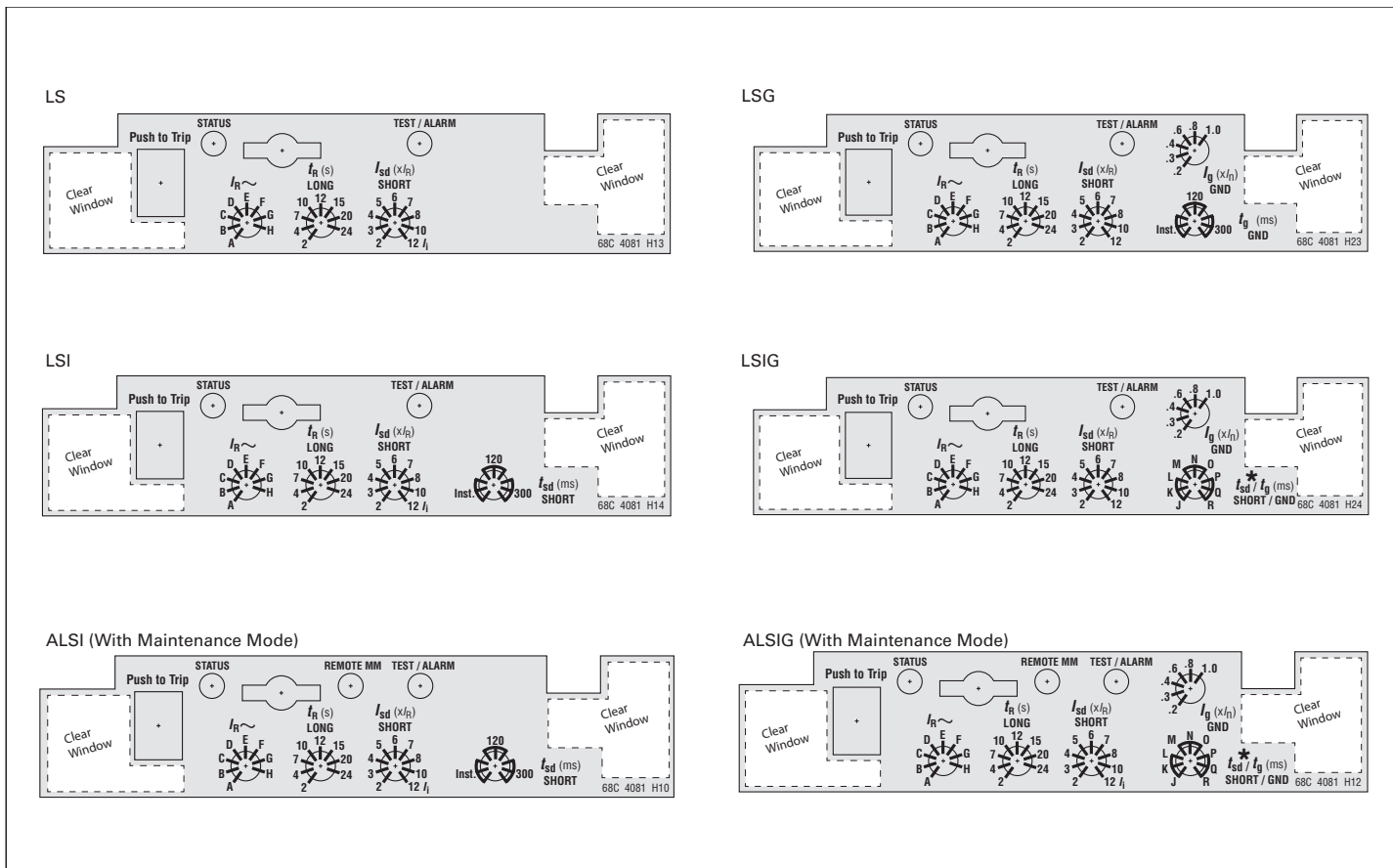

Figure 1. Digitrip 310+ Namplates

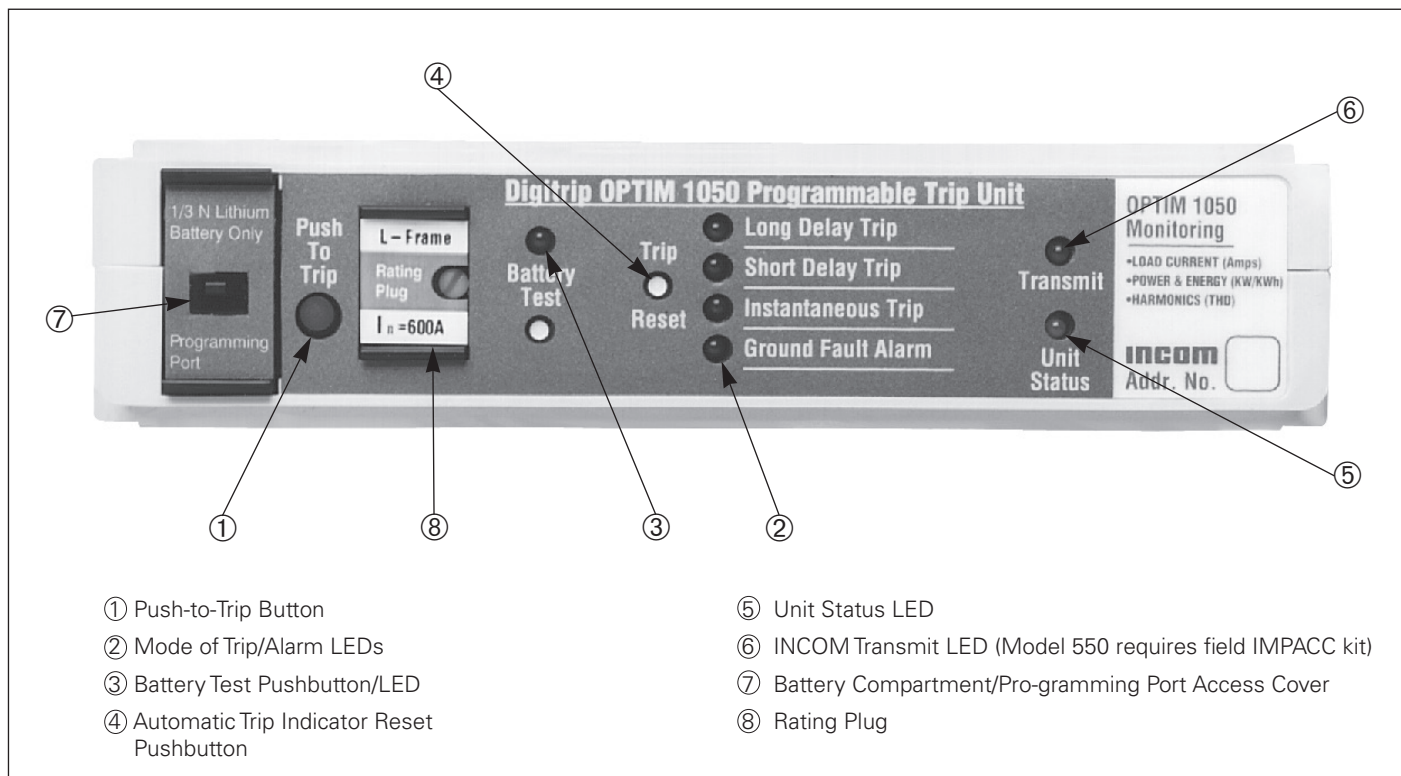
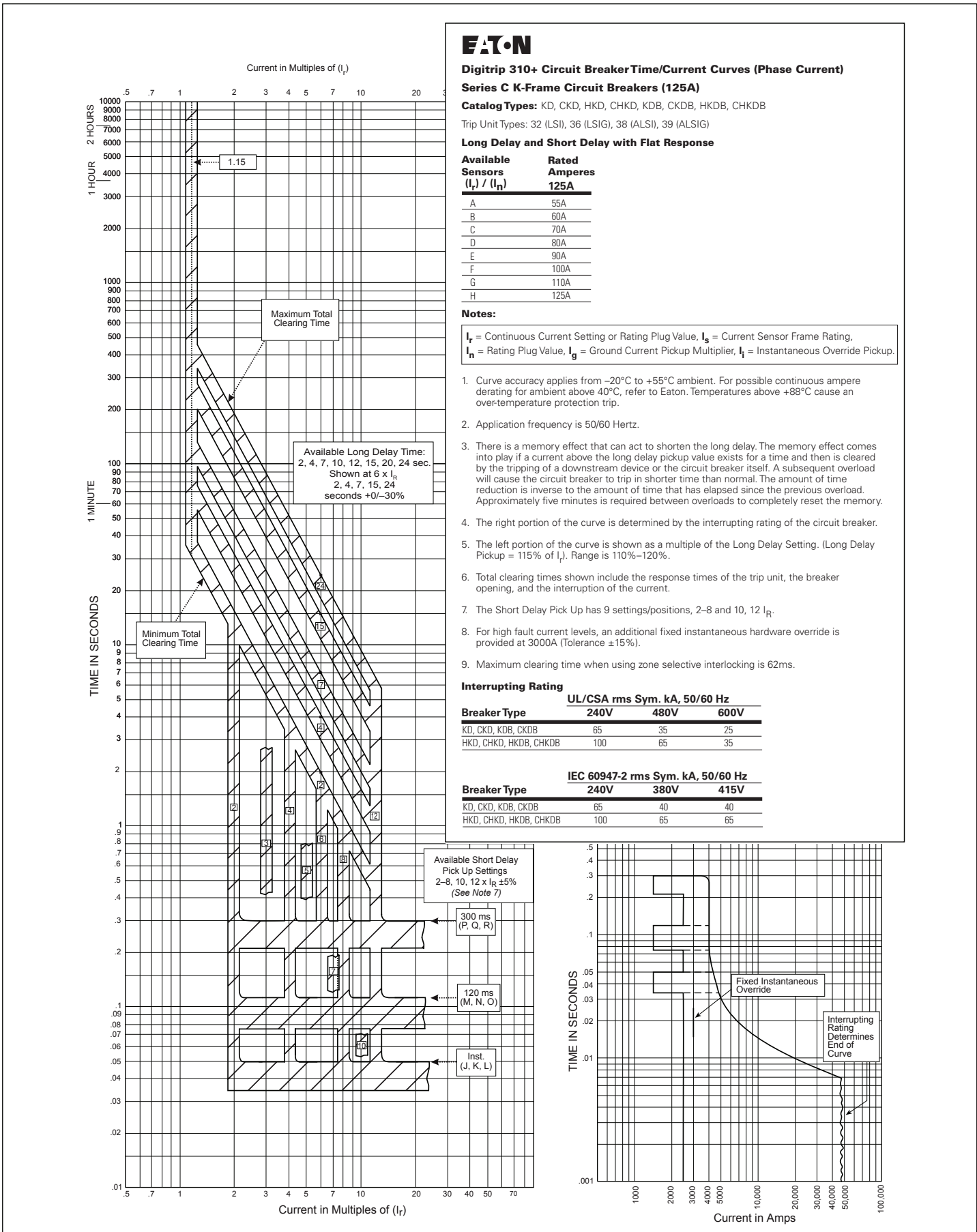

Figure 2. Front View of L-Frame Type OPTIM Trip Unit (K and N-Frame Designs are Similar)



Digitrip 310+ Circuit Breaker Time/Current Curves (Phase Current)
Series C K-Frame Circuit Breakers (125A)

Catalog Types: KD, CKD, HKD, CHKD, KDB, CKDB, HKDB, CHKDB

Trip Unit Types: 32 (LSI), 36 (LSIG), 38 (ALSI), 39 (ALSIG)

Long Delay and Short Delay with Flat Response

Available Sensors (I_r / I_n)	Rated Amperes 125A
A	55A
B	60A
C	70A
D	80A
E	90A
F	100A
G	110A
H	125A

Notes:

I_r = Continuous Current Setting or Rating Plug Value, I_s = Current Sensor Frame Rating,
 I_n = Rating Plug Value, I_g = Ground Current Pickup Multiplier, I_i = Instantaneous Override Pickup.

- Curve accuracy applies from -20°C to +55°C ambient. For possible continuous ampere derating for ambient above 40°C, refer to Eaton. Temperatures above +88°C cause an over-temperature protection trip.
- Application frequency is 50/60 Hertz.
- There is a memory effect that can act to shorten the long delay. The memory effect comes into play if a current above the long delay pickup value exists for a time and then is cleared by the tripping of a downstream device or the circuit breaker itself. A subsequent overload will cause the circuit breaker to trip in shorter time than normal. The amount of time reduction is inverse to the amount of time that has elapsed since the previous overload. Approximately five minutes is required between overloads to completely reset the memory.
- The right portion of the curve is determined by the interrupting rating of the circuit breaker.
- The left portion of the curve is shown as a multiple of the Long Delay Setting. (Long Delay Pickup = 115% of I_r). Range is 110%–120%.
- Total clearing time shown include the response times of the trip unit, the breaker opening, and the interruption of the current.
- The Short Delay Pick Up has 9 settings/positions, 2–8 and 10, 12 I_r .
- For high fault current levels, an additional fixed instantaneous hardware override is provided at 3000A (Tolerance ±15%).
- Maximum clearing time when using zone selective interlocking is 62ms.

Interrupting Rating

Breaker Type	UL/CSA rms Sym. kA, 50/60 Hz		
	240V	480V	600V
KD, CKD, KDB, CKDB	65	35	25
HKD, CHKD, HKDB, CHKDB	100	65	35

Breaker Type	IEC 60947-2 rms Sym. kA, 50/60 Hz		
	240V	380V	415V
KD, CKD, KDB, CKDB	65	40	40
HKD, CHKD, HKDB, CHKDB	100	65	65

Figure 3. Digitrip 310+ Trip Units (125A), Long Delay and Short Delay with Flat Response and Override (LSI, LSIG, ALSI, ALSIG) – Curve Number TD012014EN, September 2015

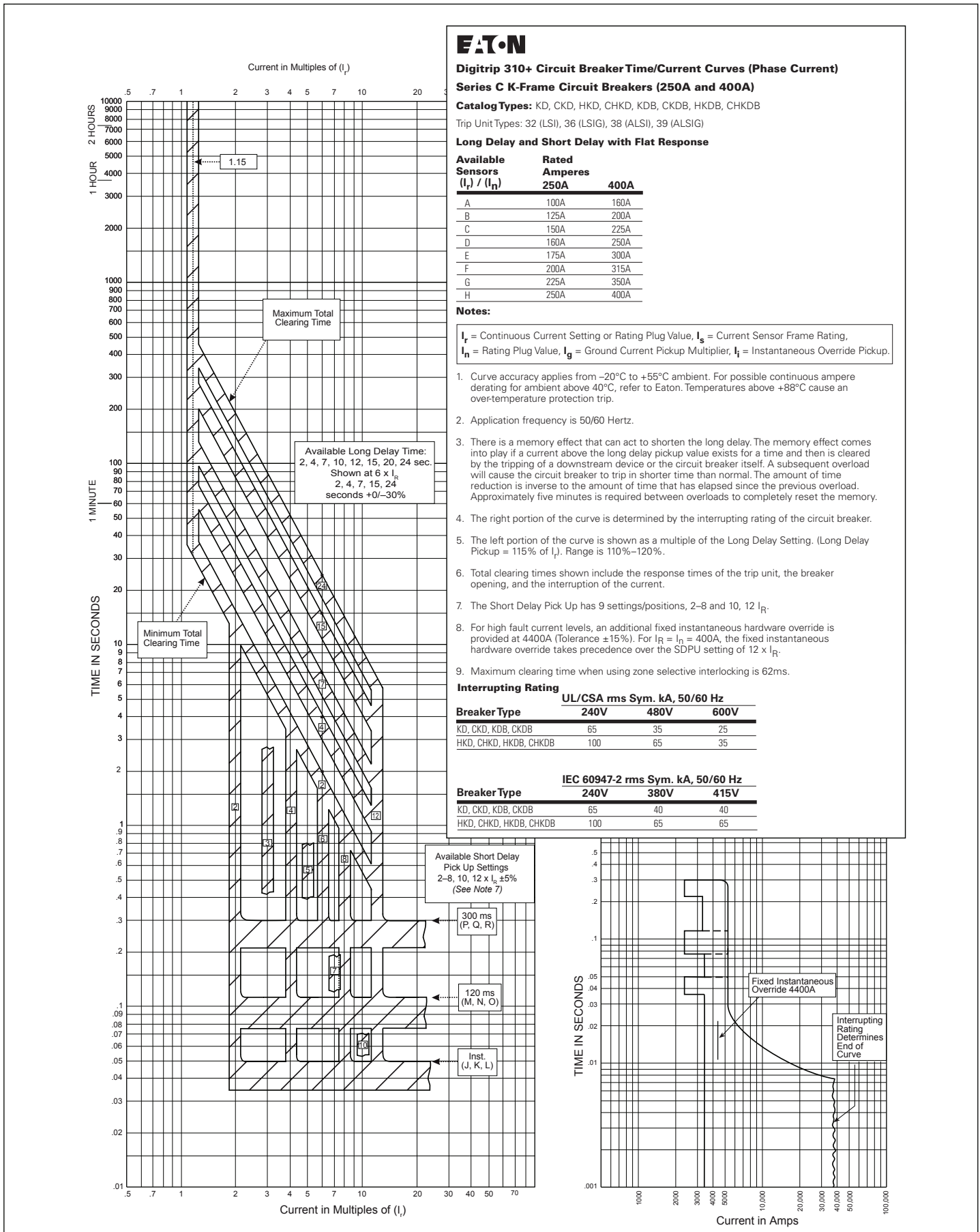

Figure 4. Digitrip 310+ Trip Units (250A and 400A), Long Delay and Short Delay with Flat Response and Override (LSI, LSIG, ALSI, ALSIG) - Curve Number TD012007EN, September 2015

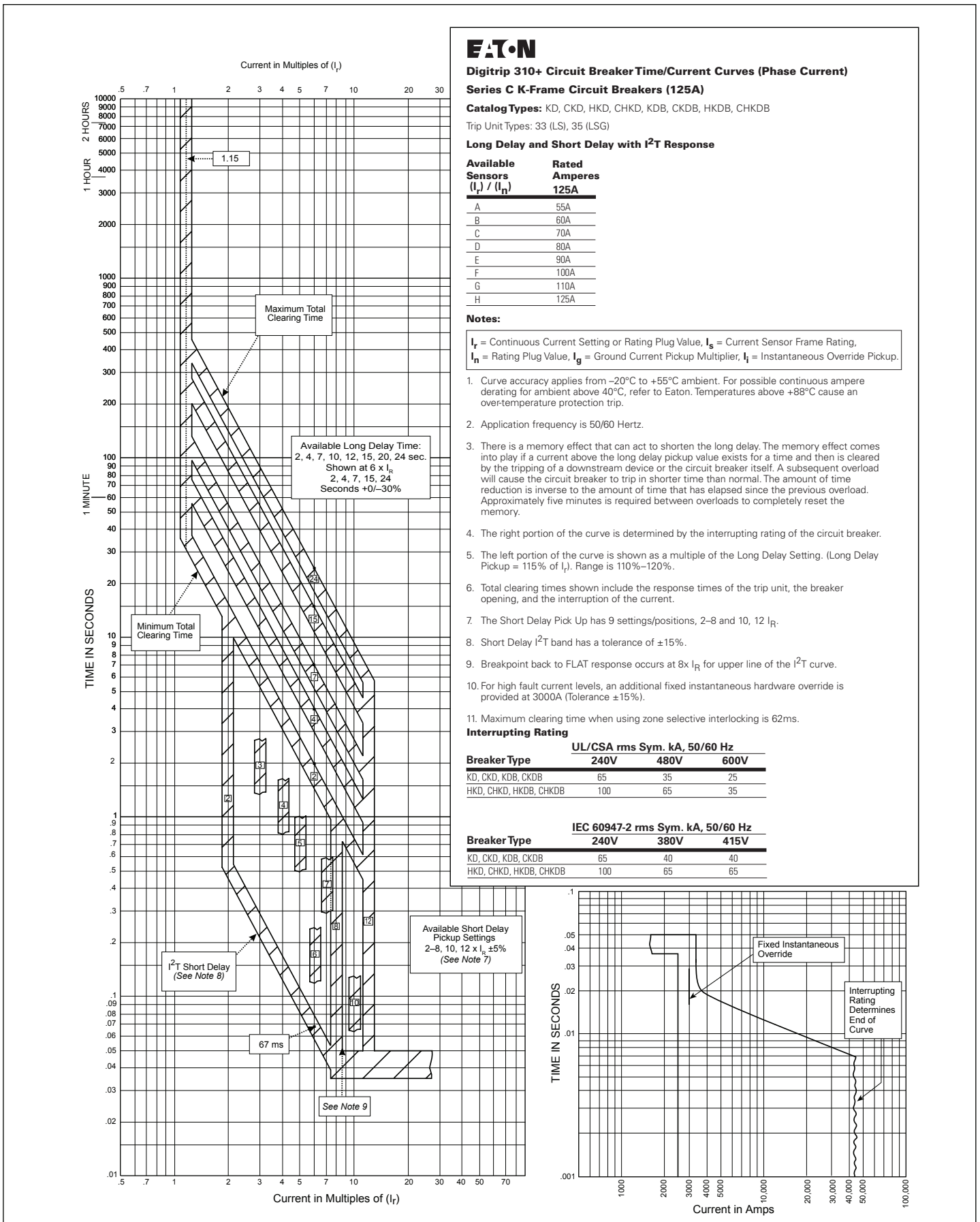

Figure 5. Digitrip 310+ Trip Units (125A), Long Delay Response and Short Delay with I²T Response Curve and Override (LS, LSG) - TD012015EN, September 2015

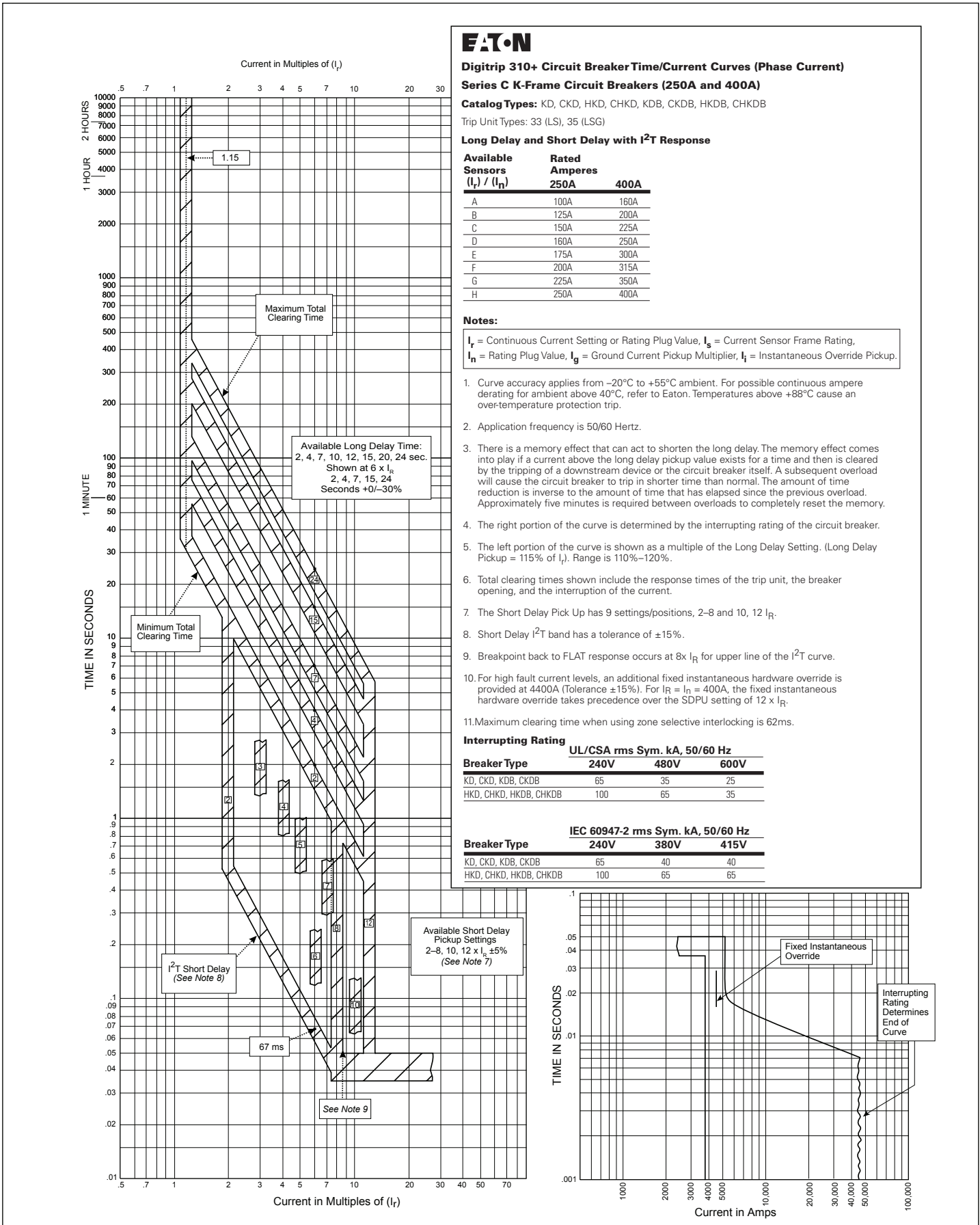
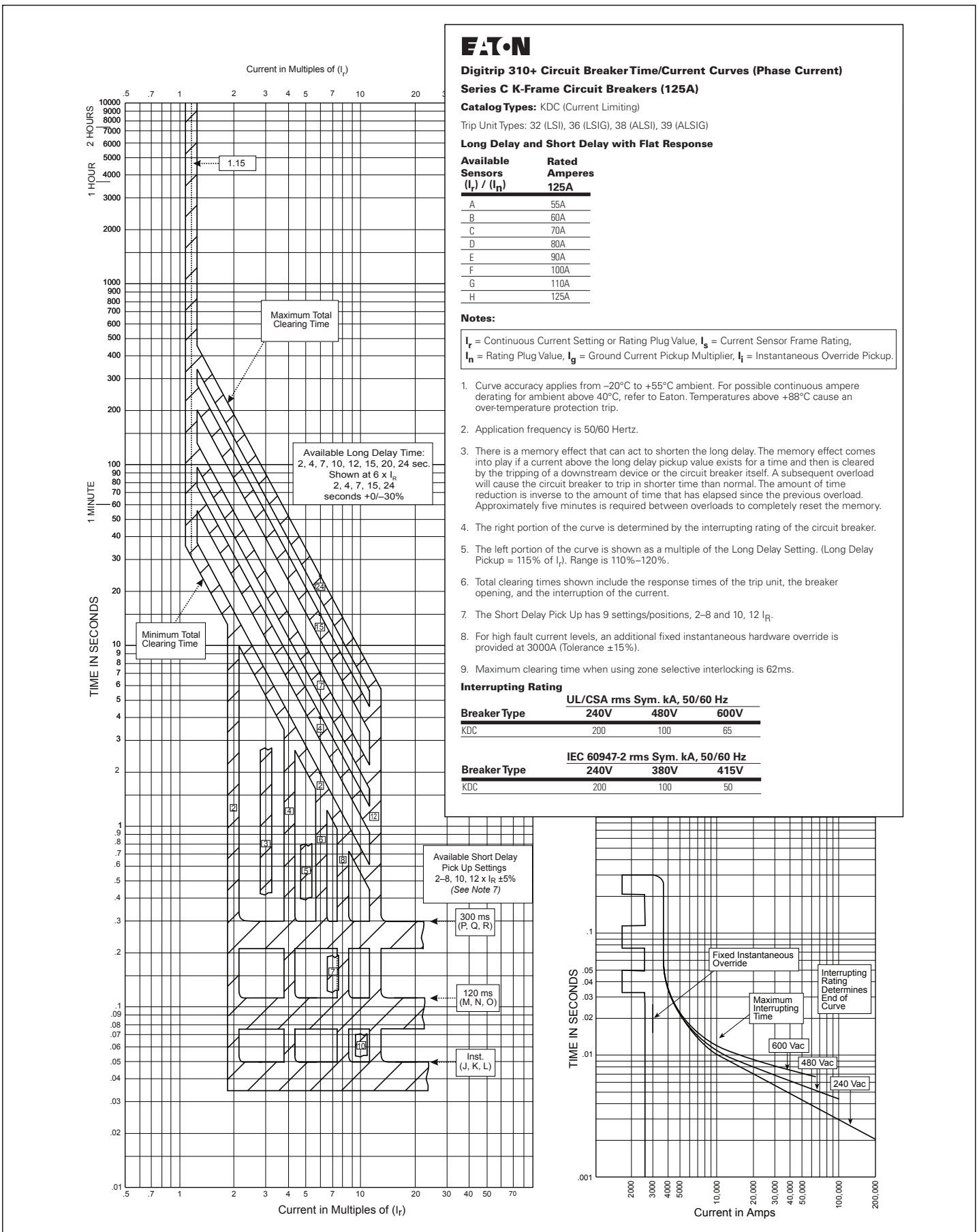

Figure 6. Digitrip 310+ Trip Units (250A and 400A), Long Delay Response and Short Delay with I²T Response Curve and Override (LS, LSG) – Curve Number TD012008EN, September 2015



Digitrip 310+ Circuit Breaker Time/Current Curves (Phase Current)
Series C K-Frame Circuit Breakers (125A)

Catalog Types: KDC (Current Limiting)

Trip Unit Types: 32 (LSI), 36 (LSIG), 38 (ALSI), 39 (ALSIG)

Long Delay and Short Delay with Flat Response

Available Sensors (I_r / I_n)	Rated Amperes 125A
A	55A
B	60A
C	70A
D	80A
E	90A
F	100A
G	110A
H	125A

Notes:

I_r = Continuous Current Setting or Rating Plug Value, I_s = Current Sensor Frame Rating,
 I_n = Rating Plug Value, I_g = Ground Current Pickup Multiplier, I_i = Instantaneous Override Pickup.

1. Curve accuracy applies from -20°C to +55°C ambient. For possible continuous ampere derating for ambient above 40°C, refer to Eaton. Temperatures above +88°C cause an over-temperature protection trip.
2. Application frequency is 50/60 Hertz.
3. There is a memory effect that can act to shorten the long delay. The memory effect comes into play if a current above the long delay pickup value exists for a time and then is cleared by the tripping of a downstream device or the circuit breaker itself. A subsequent overload will cause the circuit breaker to trip in shorter time than normal. The amount of time reduction is inverse to the amount of time that has elapsed since the previous overload. Approximately five minutes is required between overloads to completely reset the memory.
4. The right portion of the curve is determined by the interrupting rating of the circuit breaker.
5. The left portion of the curve is shown as a multiple of the Long Delay Setting. (Long Delay Pickup = 115% of I_r). Range is 110%–120%.
6. Total clearing times shown include the response times of the trip unit, the breaker opening, and the interruption of the current.
7. The Short Delay Pick Up has 9 settings/positions, 2–8 and 10, 12 I_r .
8. For high fault current levels, an additional fixed instantaneous hardware override is provided at 3000A (Tolerance ±15%).
9. Maximum clearing time when using zone selective interlocking is 62ms.

Interrupting Rating

Breaker Type	UL/CSA rms Sym. kA, 50/60 Hz		
	240V	480V	600V
KDC	200	100	65

Breaker Type	IEC 60947-2 rms Sym. kA, 50/60 Hz		
	240V	380V	415V
KDC	200	100	50

Available Short Delay Pick Up Settings
2–8, 10, 12 x I_r ±5%
(See Note 7)

300 ms (P, Q, R)

120 ms (M, N, O)

Inst. (J, K, L)

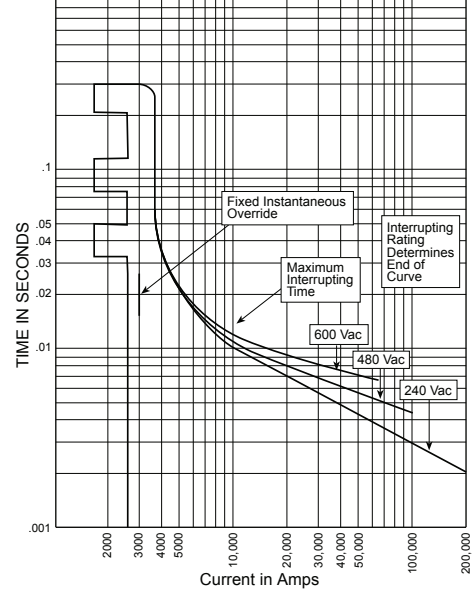

Figure 3. Digitrip 310+ Trip Units (125A), Long Delay and Short Delay with Flat Response and Override (LSI, LSIG, ALSI, ALSIG) – Curve Number TD012016EN, September 2015

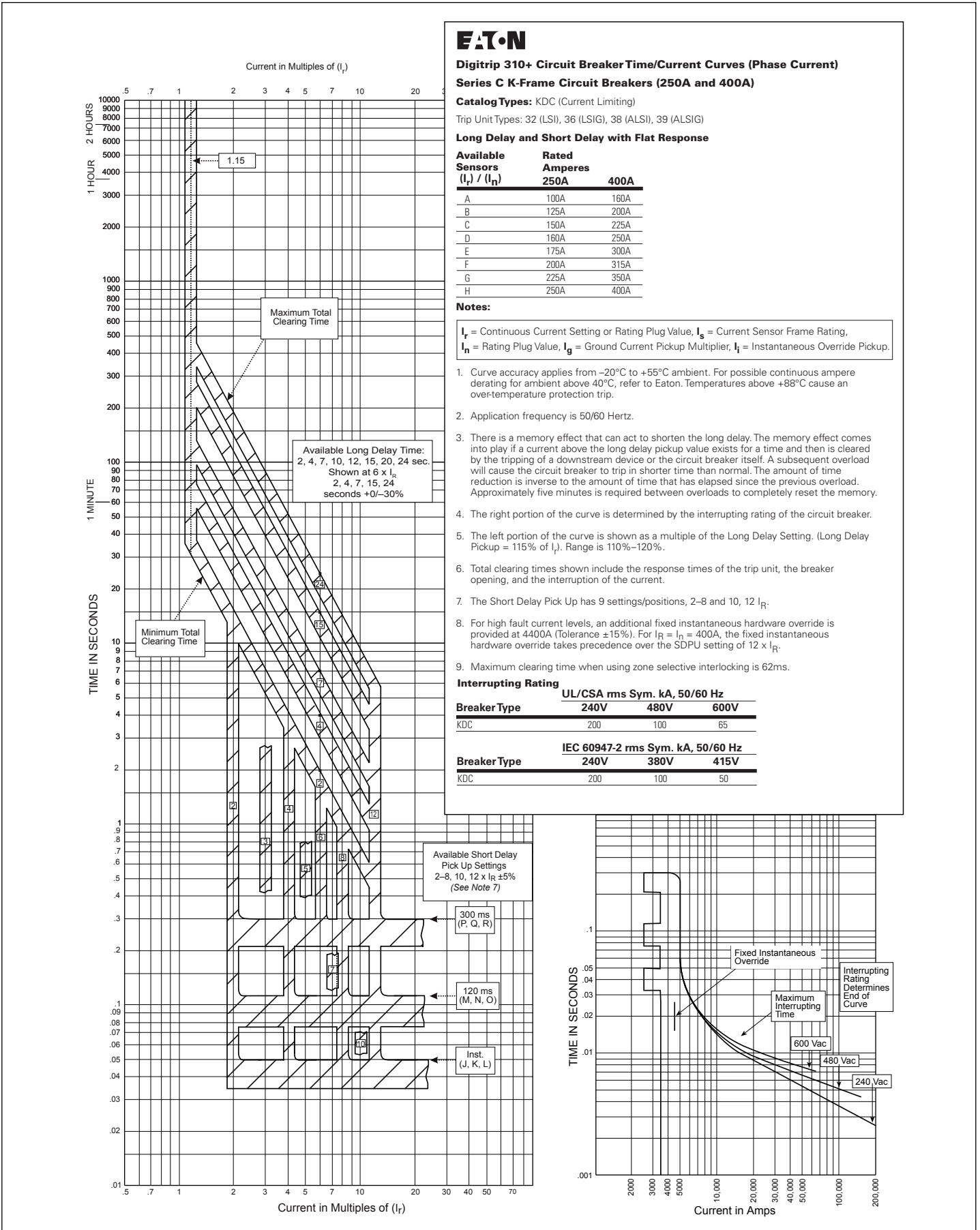

Figure 4. Digitrip 310+ Trip Units (250A and 400A), Long Delay and Short Delay with Flat Response and Override (LSI, LSIG, ALSI, ALSIG) - Curve Number TD012012EN, September 2015

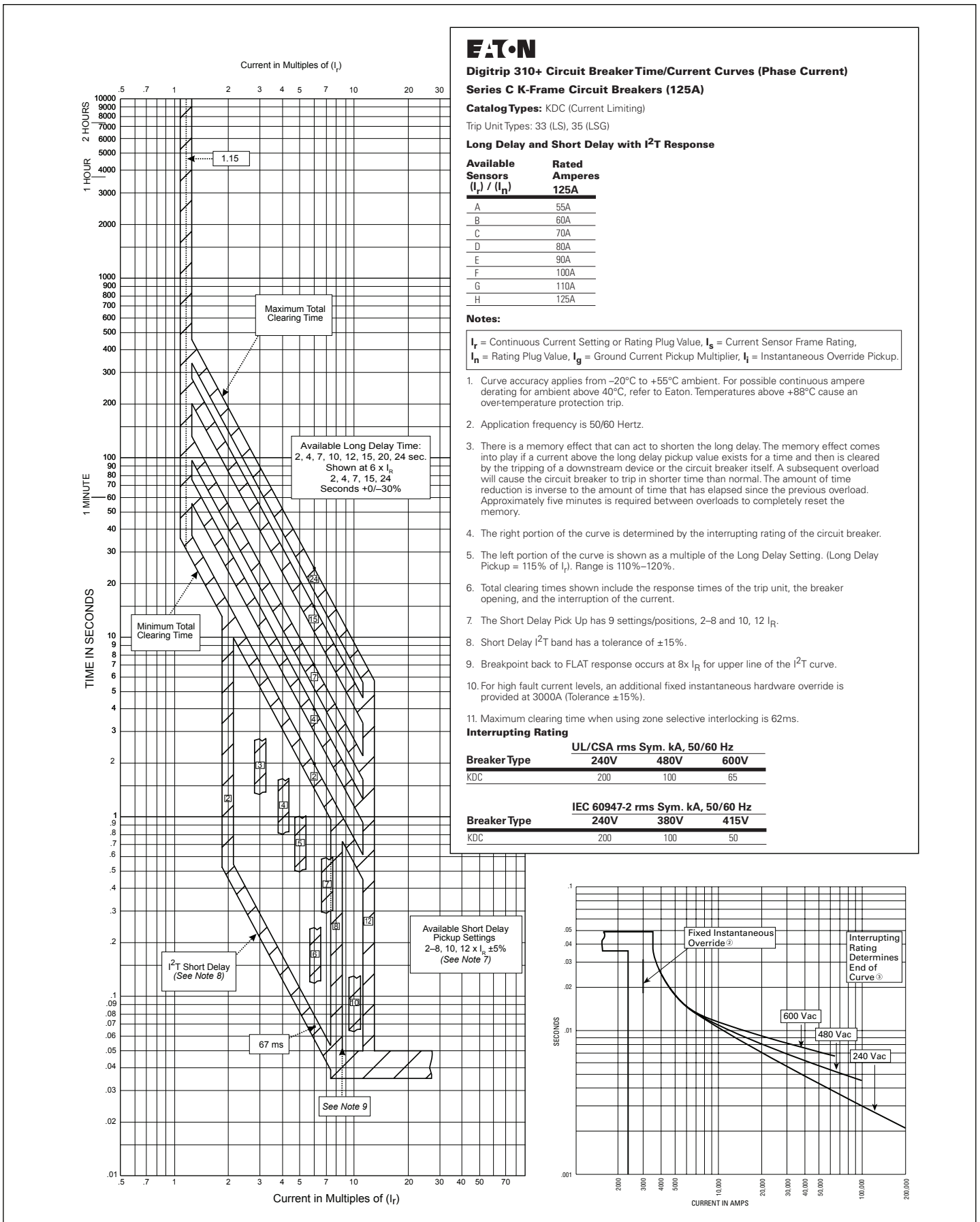

Figure 5. Digitrip 310+ Trip Units (125A), Long Delay Response and Short Delay with I²T Response Curve and Override (LS, LSG) - TD012017EN, September 2015



Digitrip 310+ Circuit Breaker Time/Current Curves (Phase Current)
Series C K-Frame Circuit Breakers (250A and 400A)

Catalog Types: KDC (Current Limiting)

Trip Unit Types: 33 (LS), 35 (LSG)

Long Delay and Short Delay with I²T Response

Available Sensors (I _r / (I _n))	Rated Amperes	
	250A	400A
A	100A	160A
B	125A	200A
C	150A	225A
D	160A	250A
E	175A	300A
F	200A	315A
G	225A	350A
H	250A	400A

Notes:

I_r = Continuous Current Setting or Rating Plug Value, I_s = Current Sensor Frame Rating, I_n = Rating Plug Value, I_g = Ground Current Pickup Multiplier, I_i = Instantaneous Override Pickup.

- Curve accuracy applies from -20°C to +55°C ambient. For possible continuous ampere derating for ambient above 40°C, refer to Eaton. Temperatures above +88°C cause an over-temperature protection trip.
- Application frequency is 50/60 Hertz.
- There is a memory effect that can act to shorten the long delay. The memory effect comes into play if a current above the long delay pickup value exists for a time and then is cleared by the tripping of a downstream device or the circuit breaker itself. A subsequent overload will cause the circuit breaker to trip in shorter time than normal. The amount of time reduction is inverse to the amount of time that has elapsed since the previous overload. Approximately five minutes is required between overloads to completely reset the memory.
- The right portion of the curve is determined by the interrupting rating of the circuit breaker.
- The left portion of the curve is shown as a multiple of the Long Delay Setting. (Long Delay Pickup = 115% of I_r). Range is 110%–120%.
- Total clearing times shown include the response times of the trip unit, the breaker opening, and the interruption of the current.
- The Short Delay Pick Up has 9 settings/positions, 2–8 and 10, 12 I_R.
- Short Delay I²T band has a tolerance of ±15%.
- Breakpoint back to FLAT response occurs at 8x I_R for upper line of the I²T curve.
- For high fault current levels, an additional fixed instantaneous hardware override is provided at 4400A (Tolerance ±15%). For I_R = I_n = 400A, the fixed instantaneous hardware override takes precedence over the SDPU setting of 12 x I_R.
- Maximum clearing time when using zone selective interlocking is 62ms.

Interrupting Rating

Breaker Type	UL/CSA rms Sym. kA, 50/60 Hz		
	240V	480V	600V
KDC	200	100	65

Breaker Type	IEC 60947-2 rms Sym. kA, 50/60 Hz		
	240V	380V	415V
KDC	200	100	50

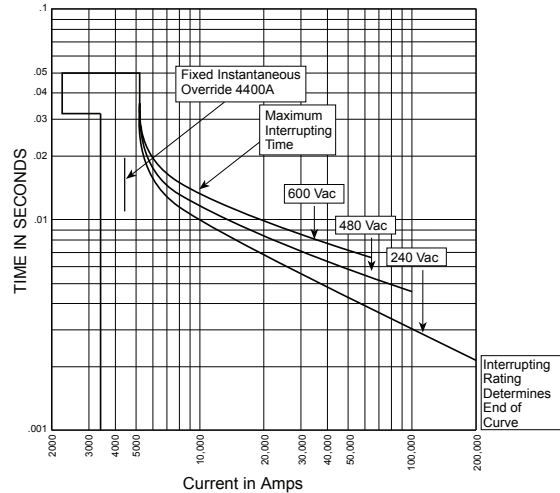
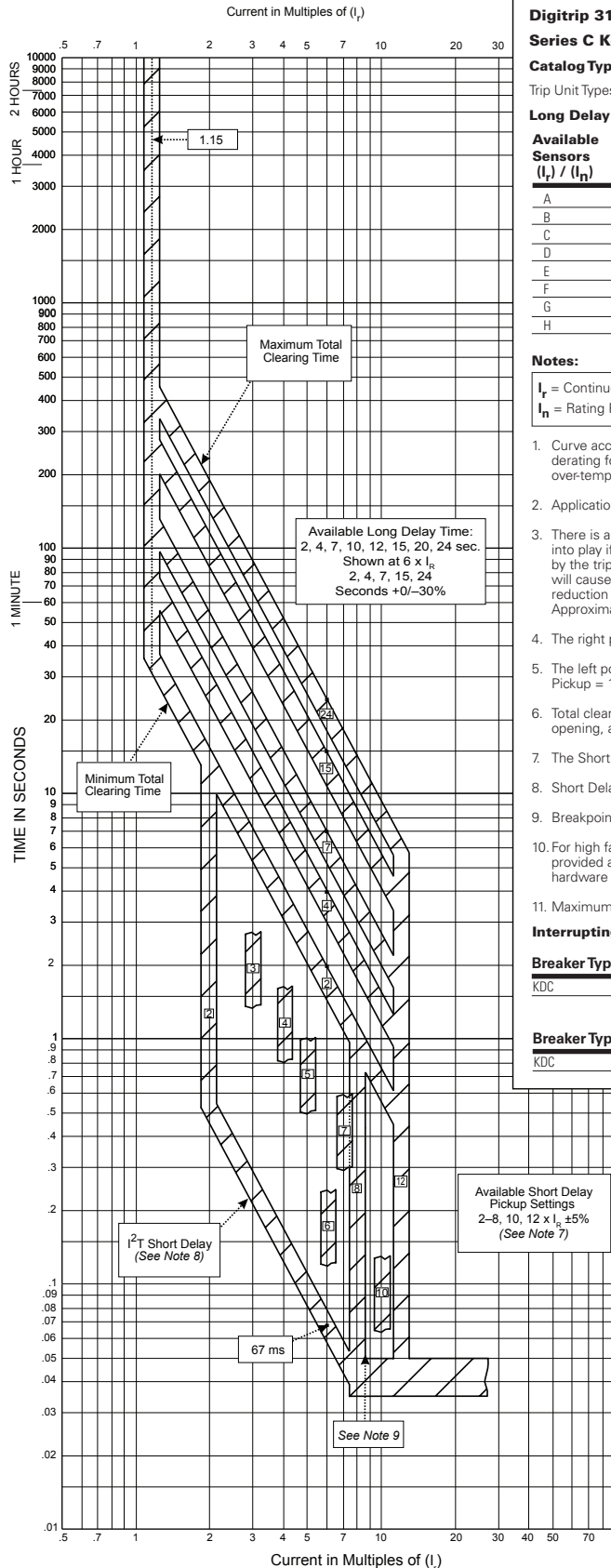

Figure 6. Digitrip 310+ Trip Units (250A and 400A), Long Delay Response and Short Delay with I²T Response Curve and Override (LS, LSG) – Curve Number TD012013EN, September 2015

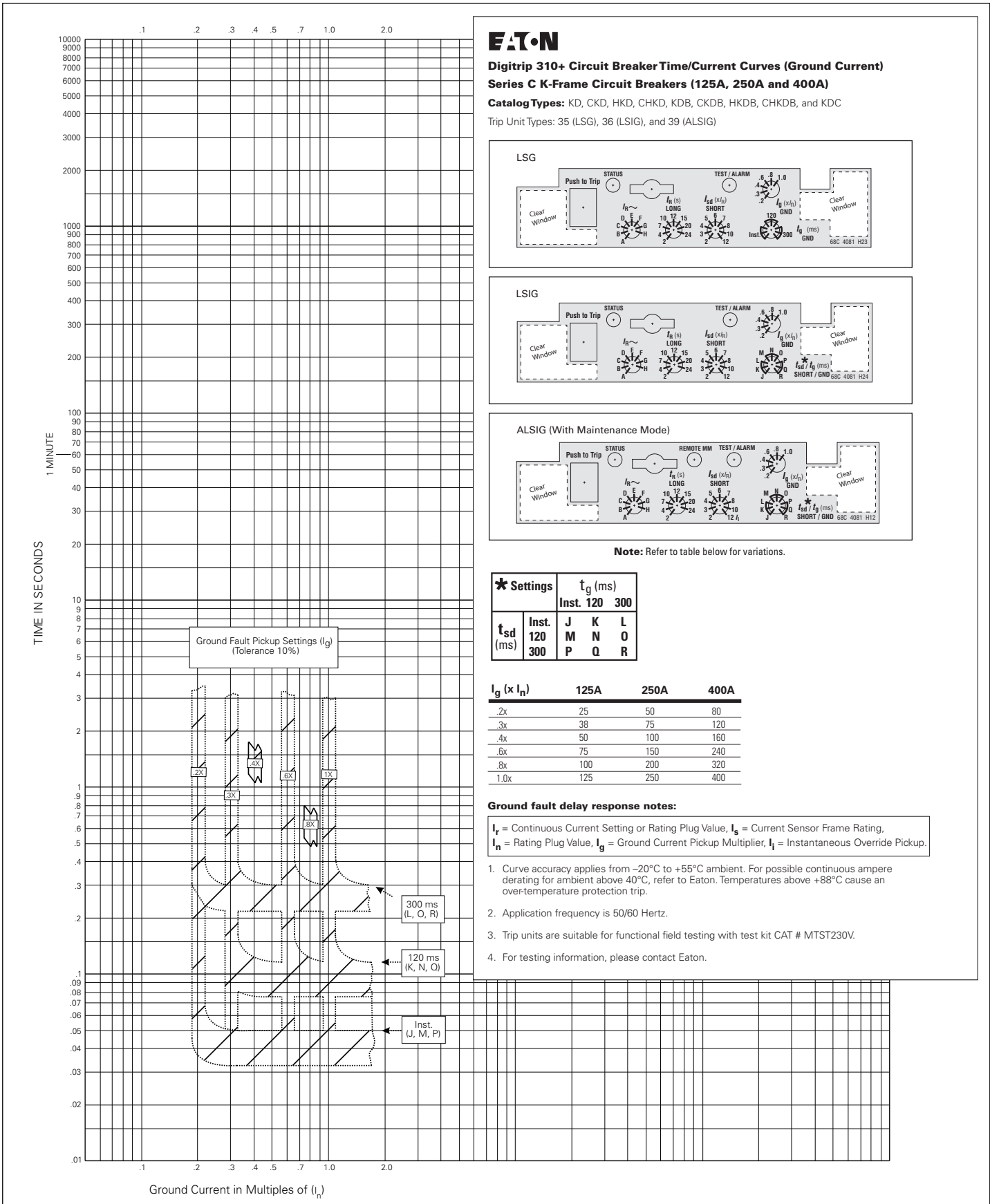
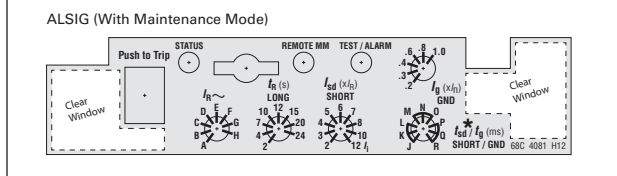
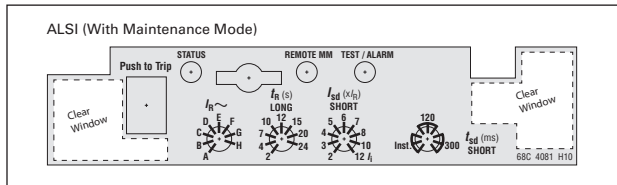

Figure 7. Ground Fault Delay Response Curve (LSD, LSIG, ALSIG) - Curve Number TD012009EN



Digitrip 310+ Circuit Breaker Time/Current Curves
Maintenance Mode Setting
Series C K-Frame Trip Unit Nameplates



I_r = Continuous Current Setting or Rating Plug Value, I_s = Current Sensor Frame Rating,
 I_n = Rating Plug Value, I_g = Ground Current Pickup Multiplier, I_i = Instantaneous Override Pickup.

Notes:

1. The Maintenance Mode feature must be ENABLED via application of 24 Vdc for these curves to apply. The blue LED is lit when in Maintenance Mode.
2. The end of the curve is determined by the interrupting rating of the circuit breaker.
3. Total clearing times shown include the response times of the trip unit, the breaker opening, and the interruption of the current.
4. Nominal Values (Pickup) (Tolerance is $\pm 15\%$) $2.5 \times I_n$.
5. The total clearing times shown are conservative and consider the maximum response time of the trip unit, the circuit breaker opening, and the interruption of the current in the worst case conditions such as: maximum rated voltages, single-phase interruption, and minimum power factor. Faster clearing times are possible depending on the specific system conditions.

Contact Eaton for additional information.

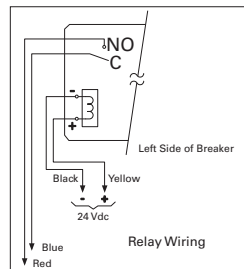

Maintenance Mode Trip

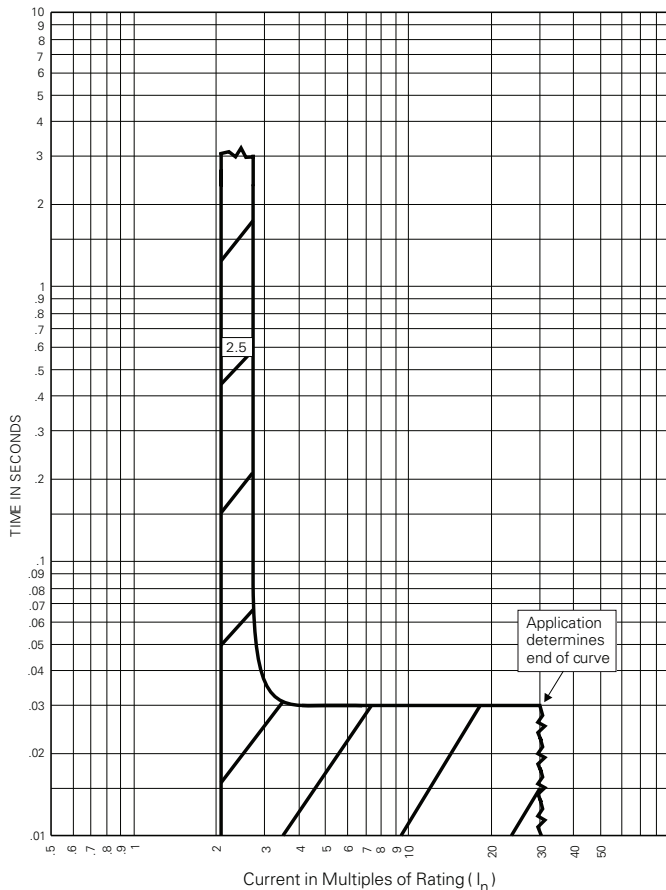

Figure 8. Maintenance Mode Setting (ALSI, ALSIG) - Curve Number TD012010EN, February 2014

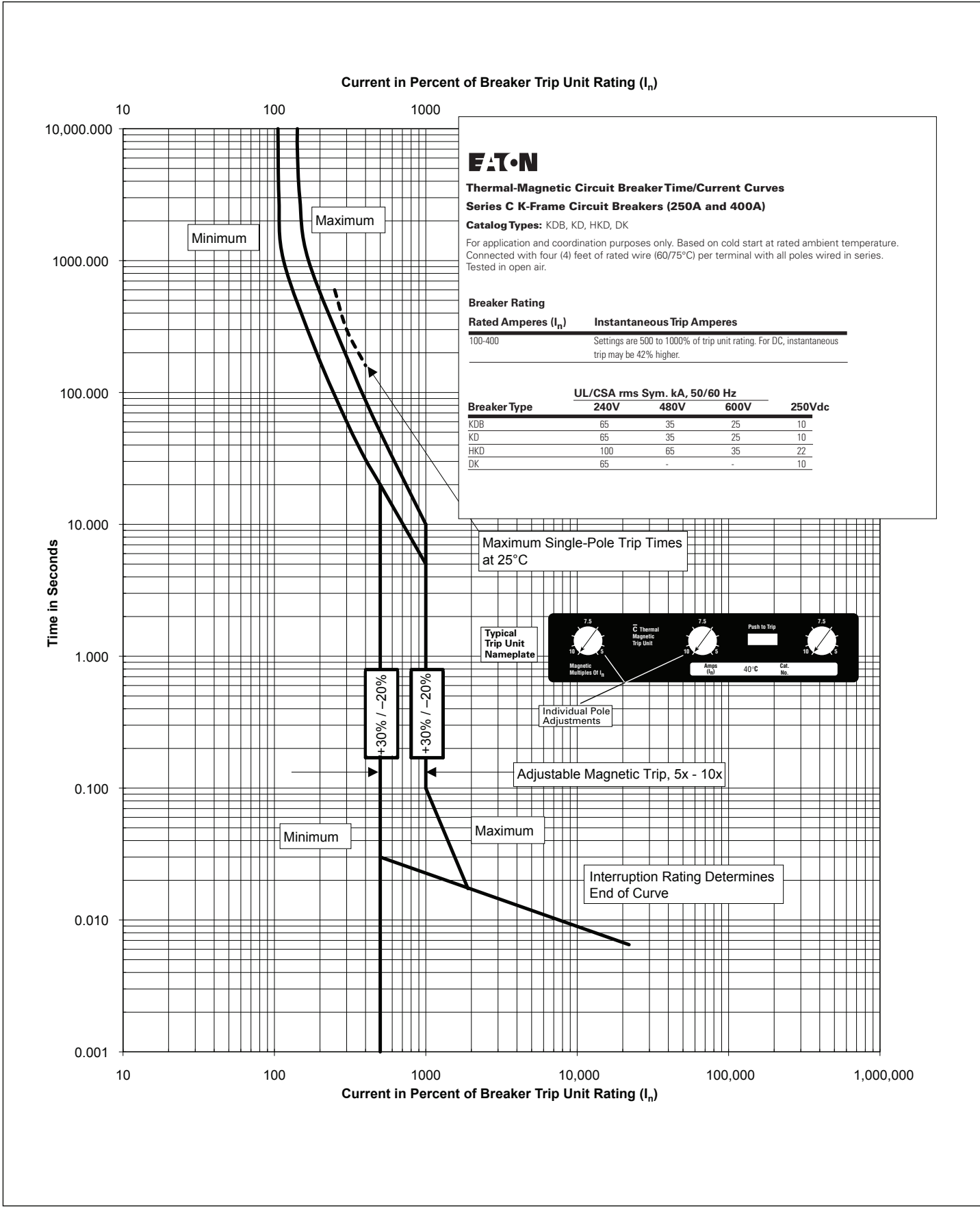

Figure 9. Thermal-Magnetic Series C Types KDB, KD, HKD Circuit Breakers - Curve Number SC-4118-87B, February 2014

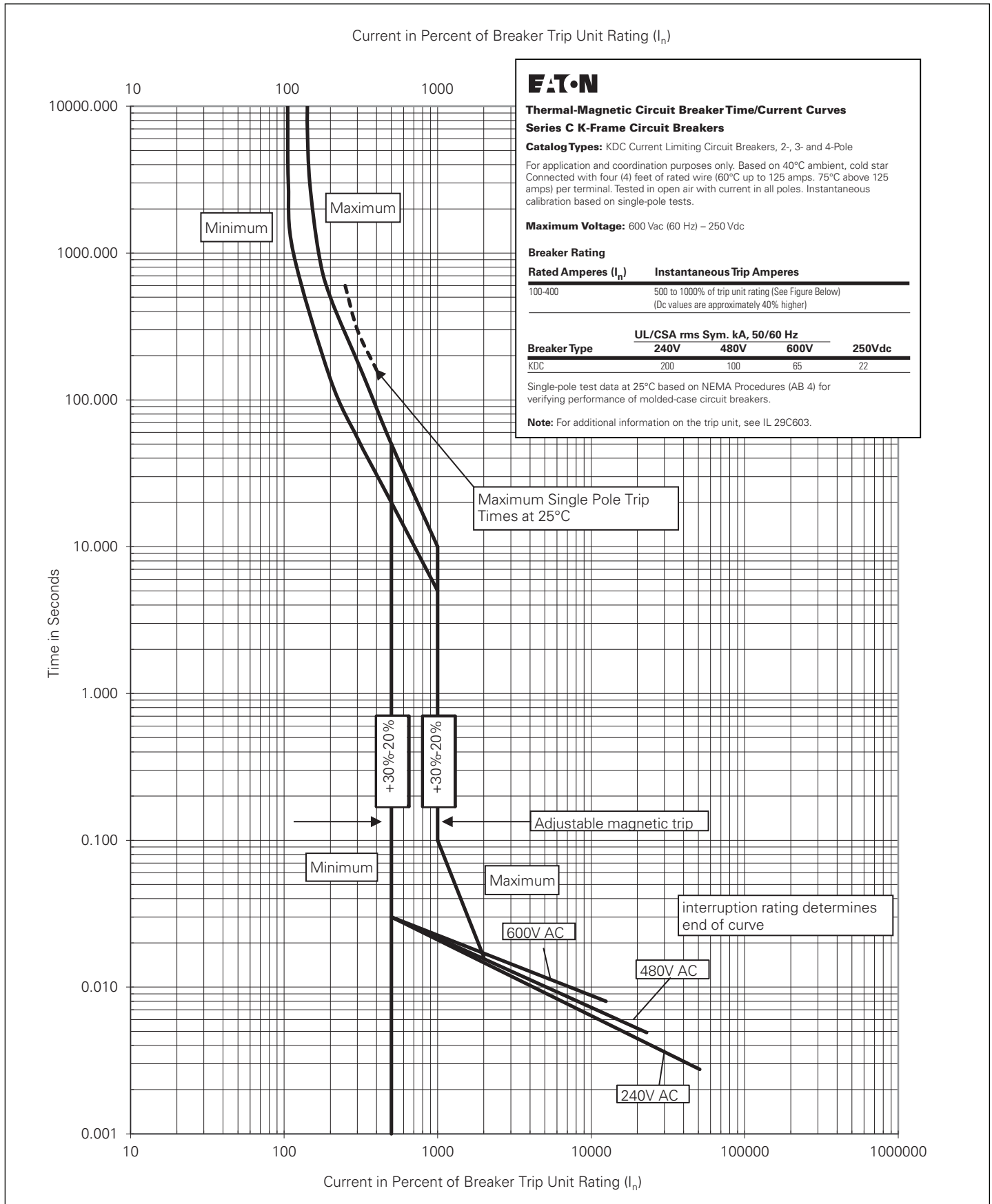

Figure 10. Thermal-Magnetic Series C Type KDC Circuit Breakers - Curve Number SC-4119-87B, February 2014

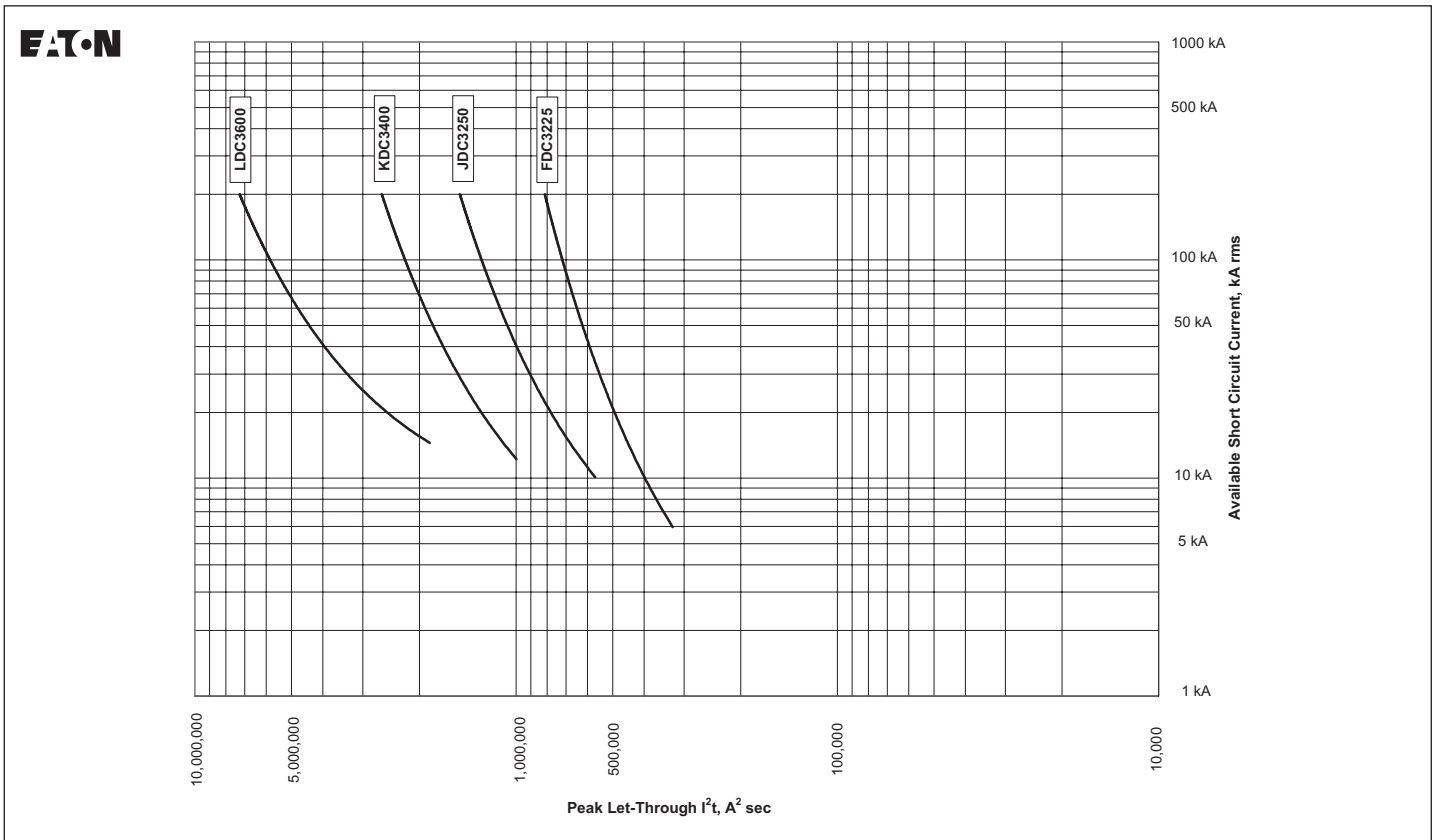

Figure 11. Peak Let-Through I^2t Curve — 240 V - Curve Number AD-29-166A

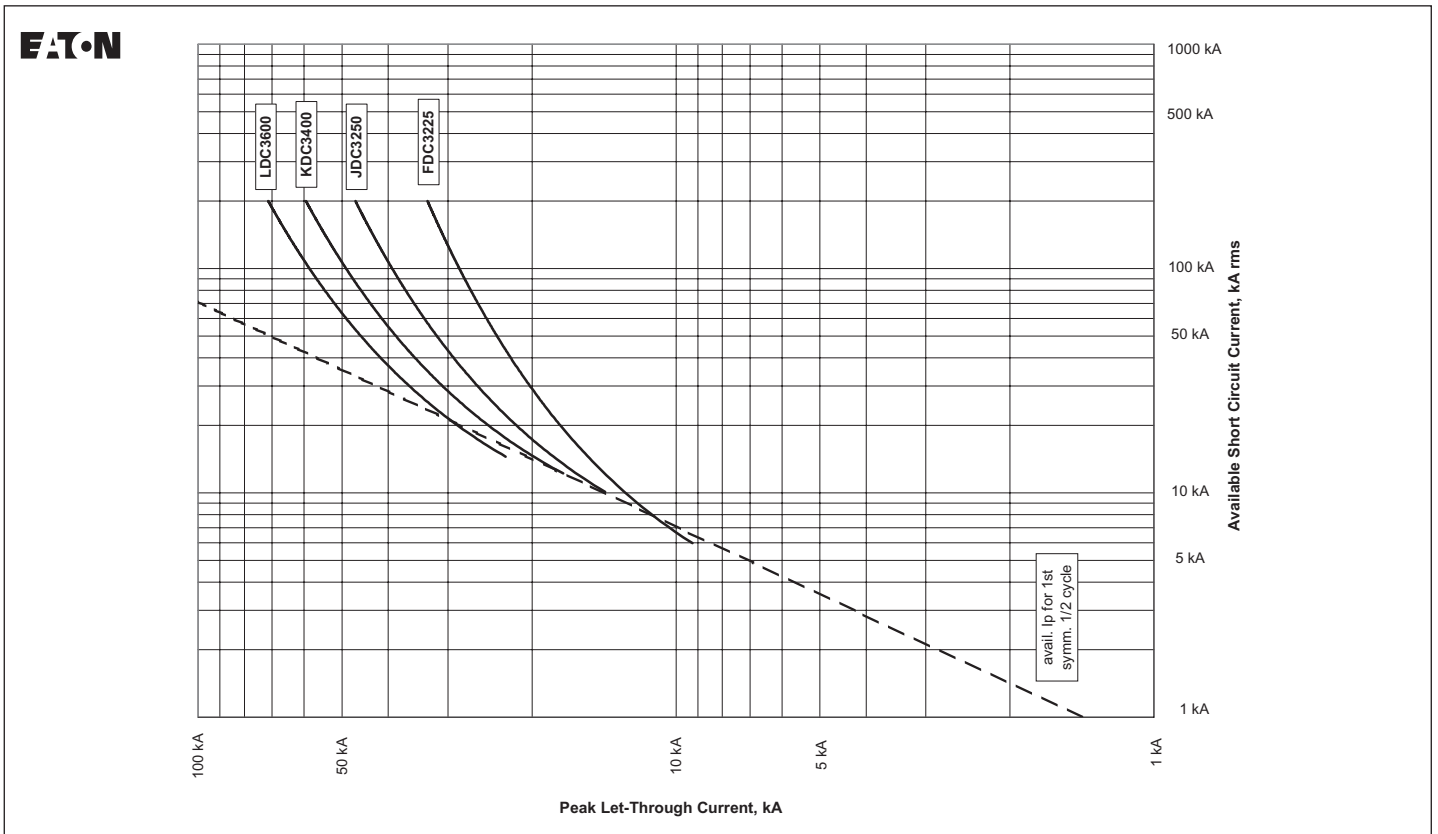

Figure 12. Peak Let-Through Current Curve — 240 V - Curve Number AD-29-166A

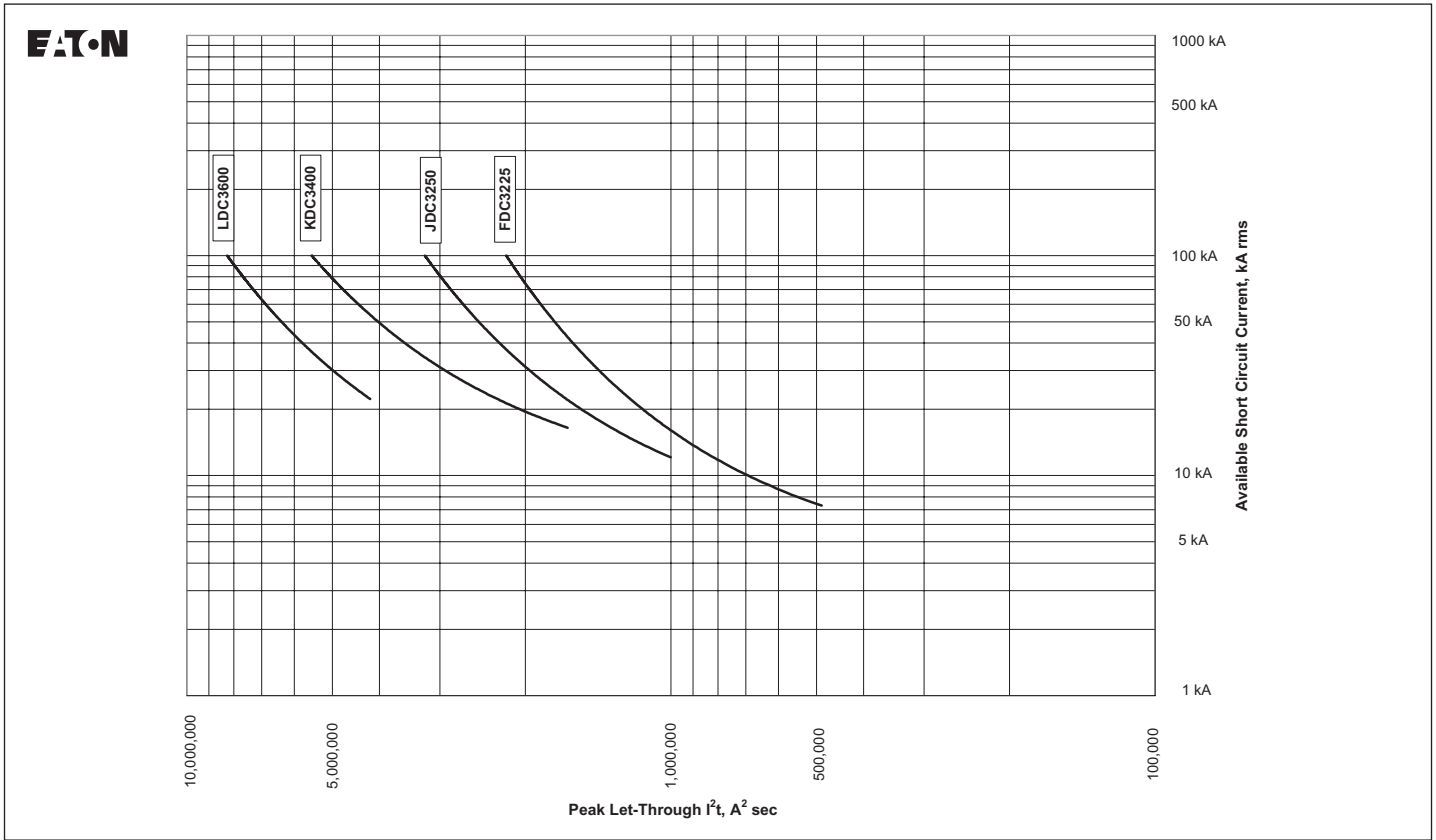

Figure 13. Peak Let-Through I²t Curve — 480 V - Curve Number AD-29-166B

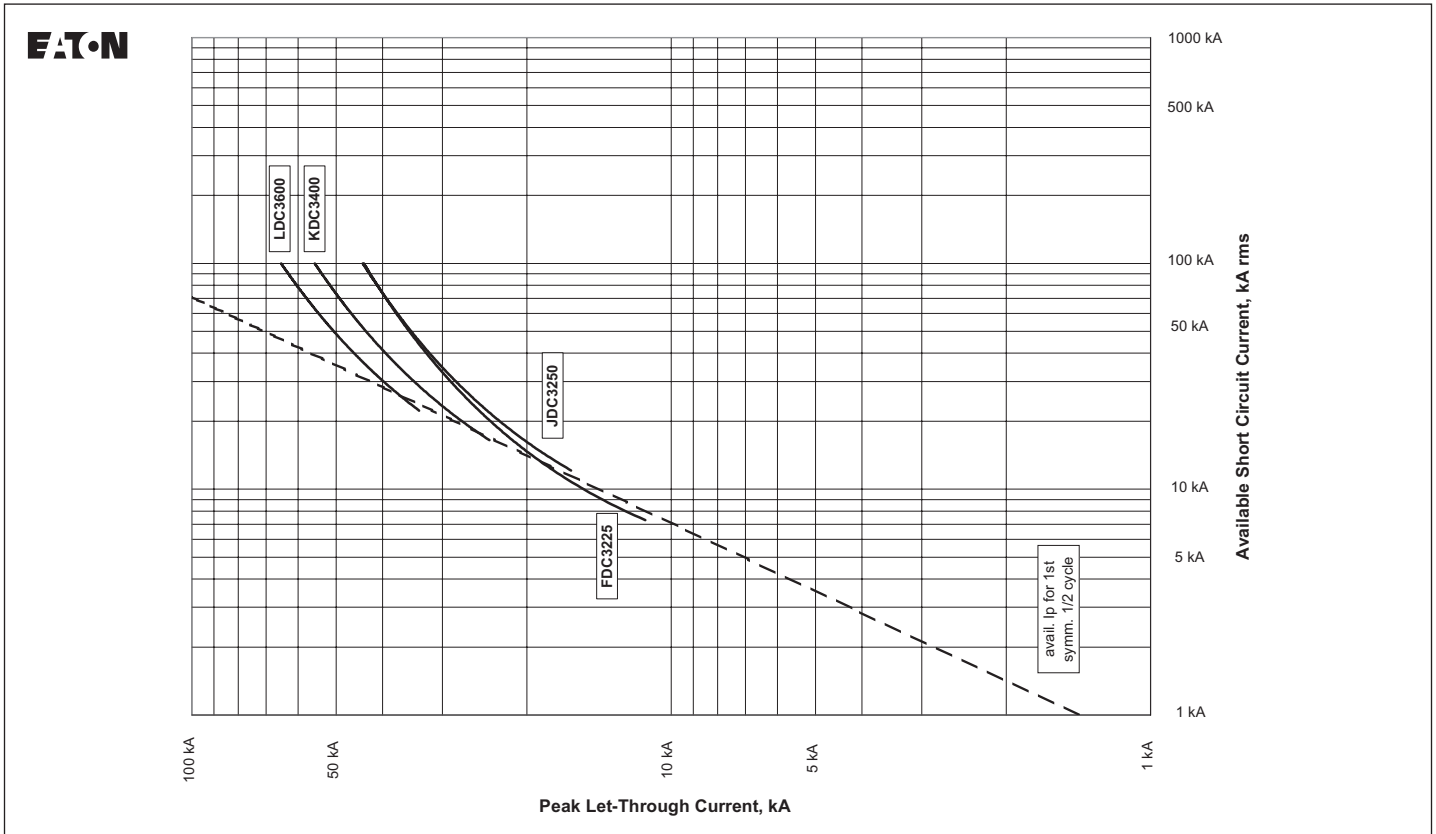

Figure 14. Peak Let-Through Current — 480 V - Curve Number AD-29-166B

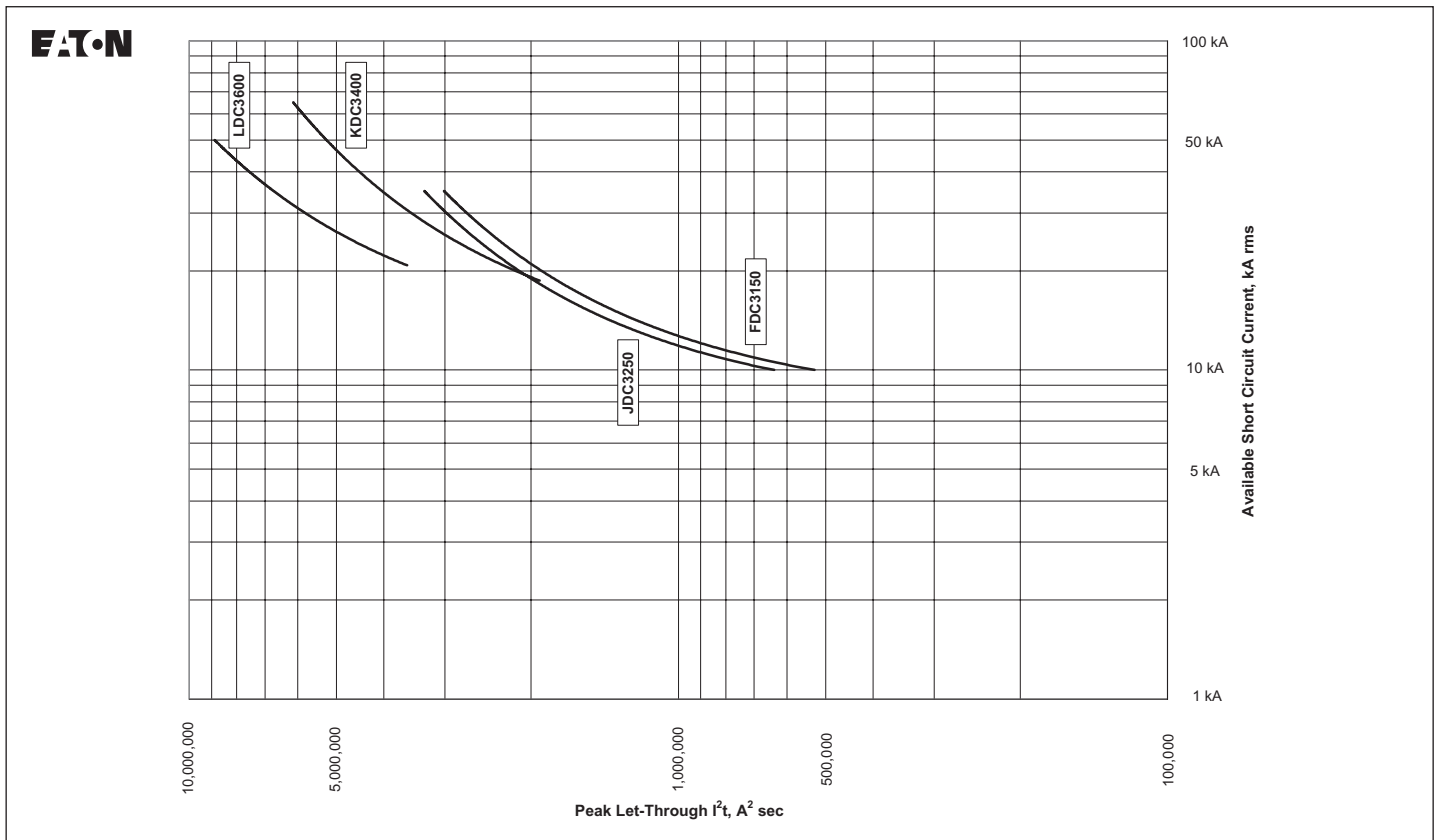

Figure 15. Peak Let-Through I^2t — 600 V - Curve Number AD-29-166C

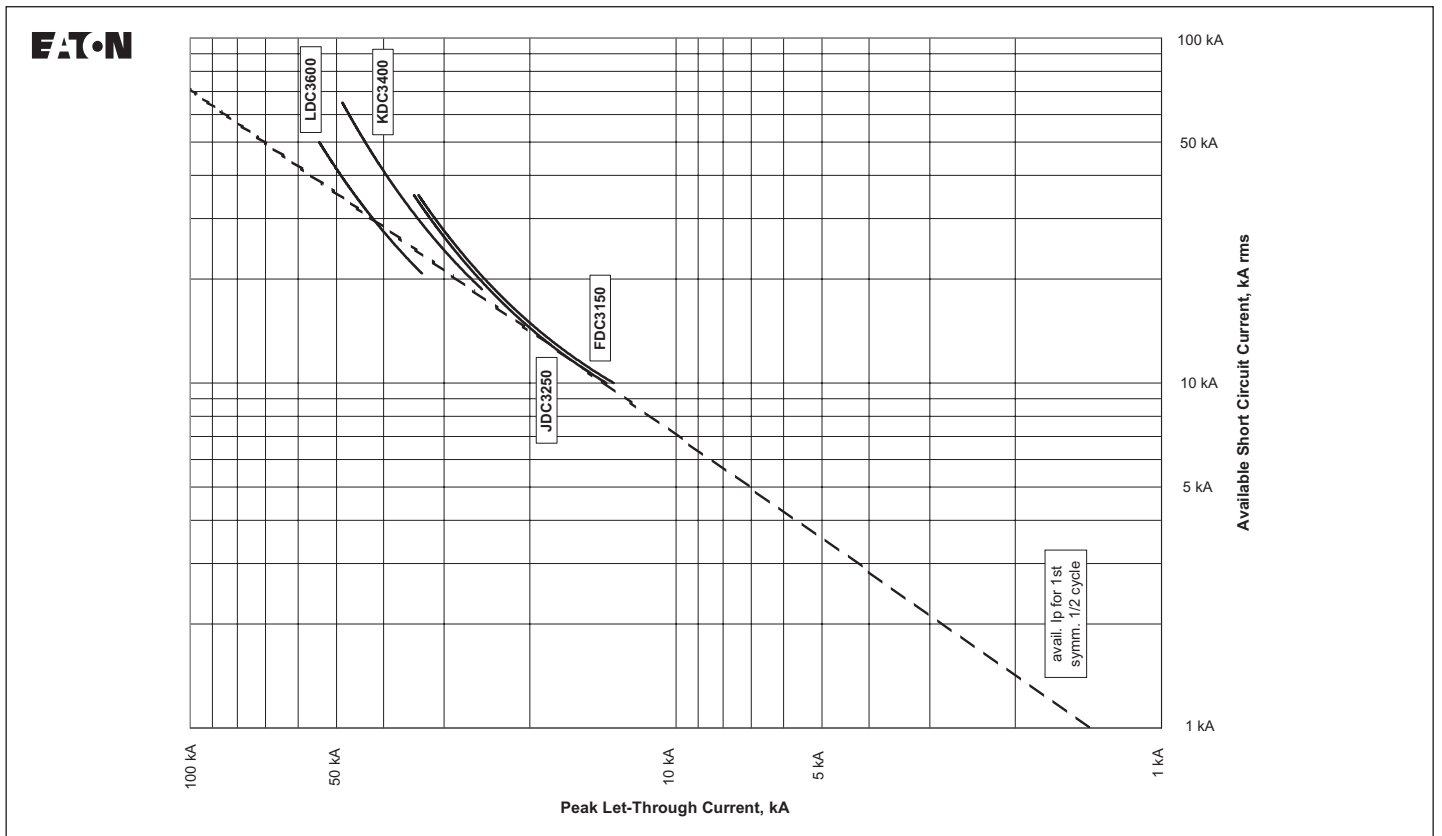

Figure 16. Peak Let-Through Current — 600 V - Curve Number AD-29-166C

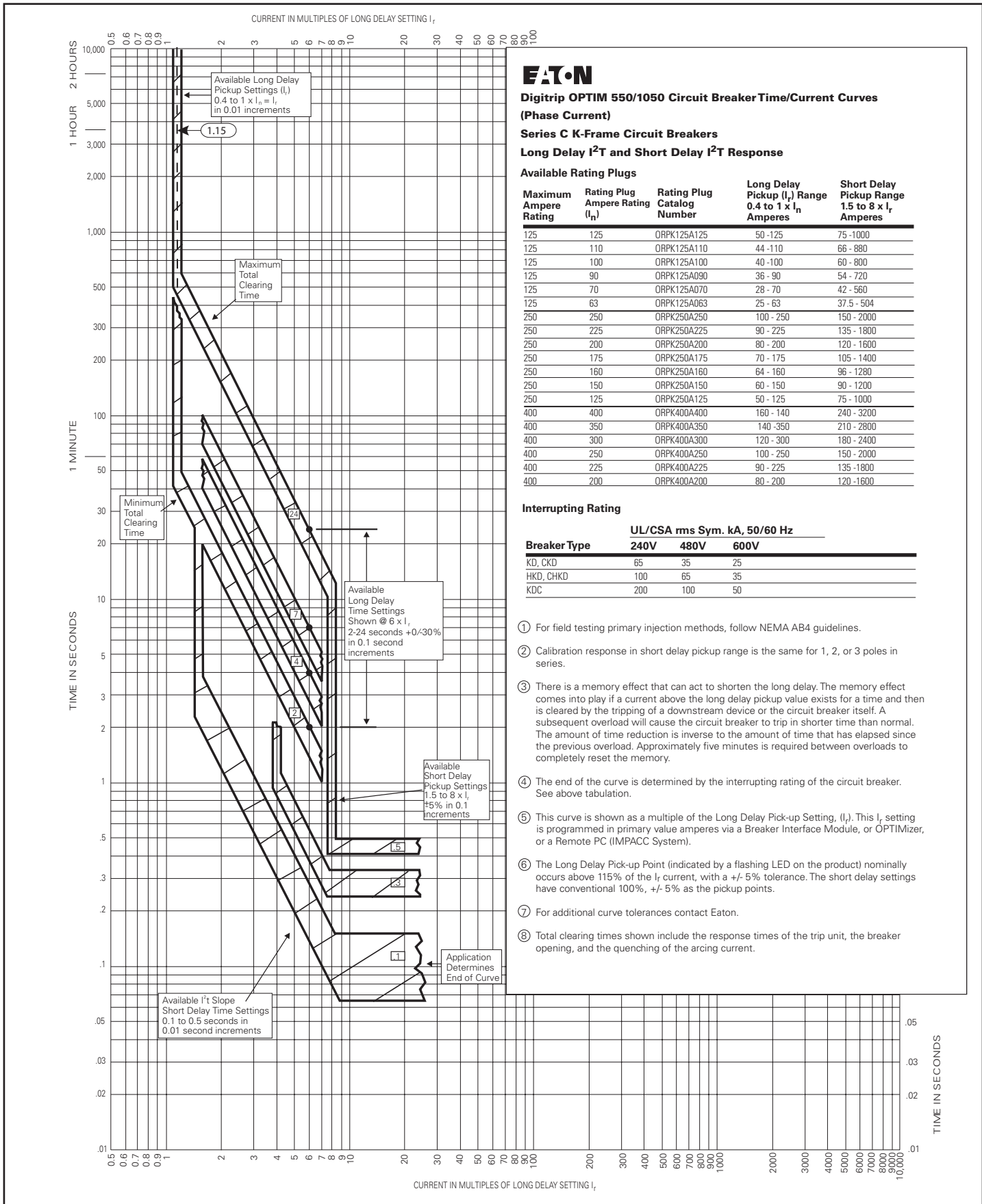

Figure 17. Digitrip Optim Long Delay I²T and Short Delay I²T Response - Curve Number SC-6924-98, May 1998

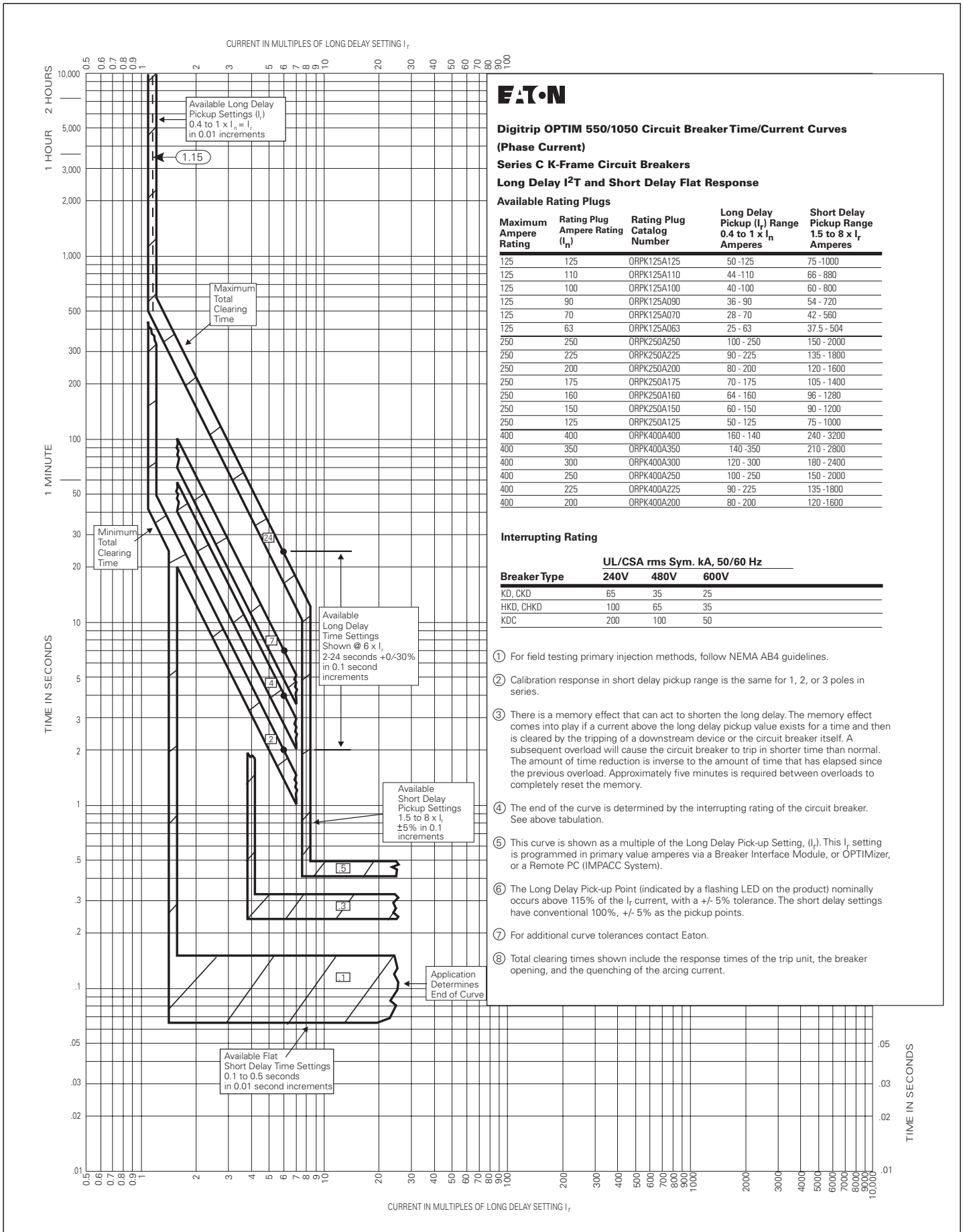

Figure 18. Digitrip Optim Long Delay I²T and Short Delay Flat Response - Curve Number SC-6925-98, May 1998

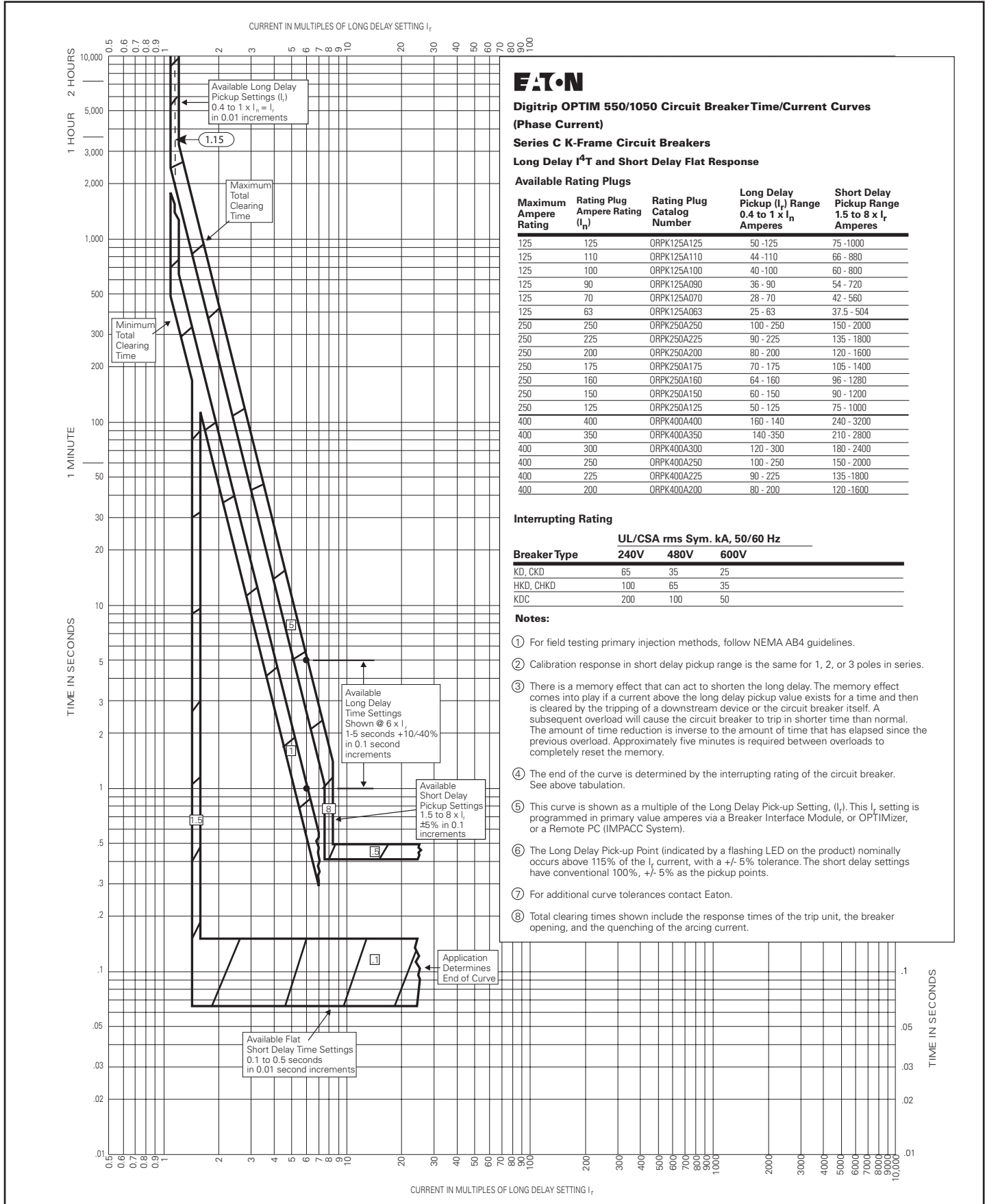

Figure 19. Digitrip Optim Long Delay I⁴T and Short Delay Flat Response - Curve Number SC-6926-98, May 1998

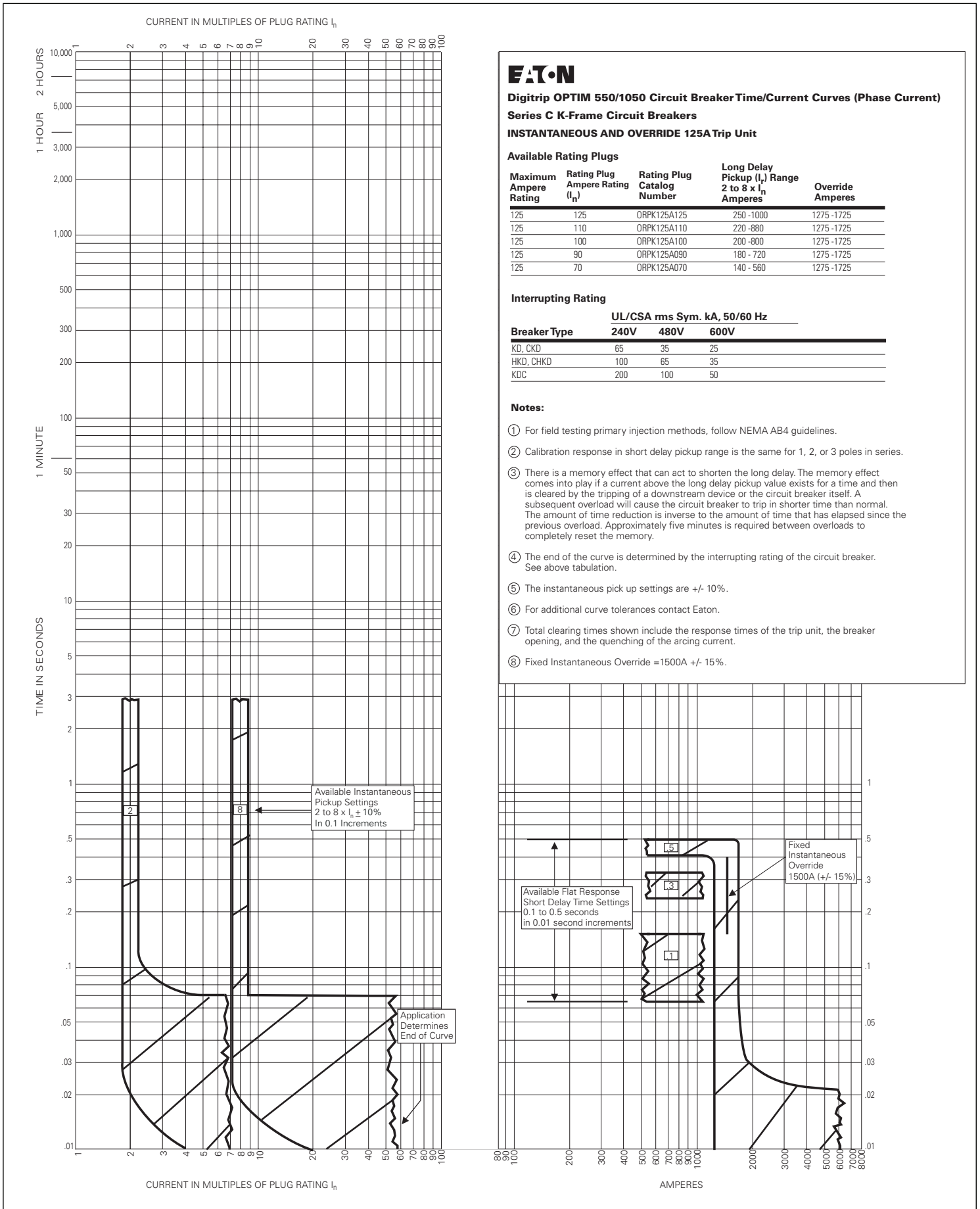

Figure 20. Digitrip Optim Instantaneous and Override, 125A Trip Unit - Curve Number SC-6927-98, May 1998

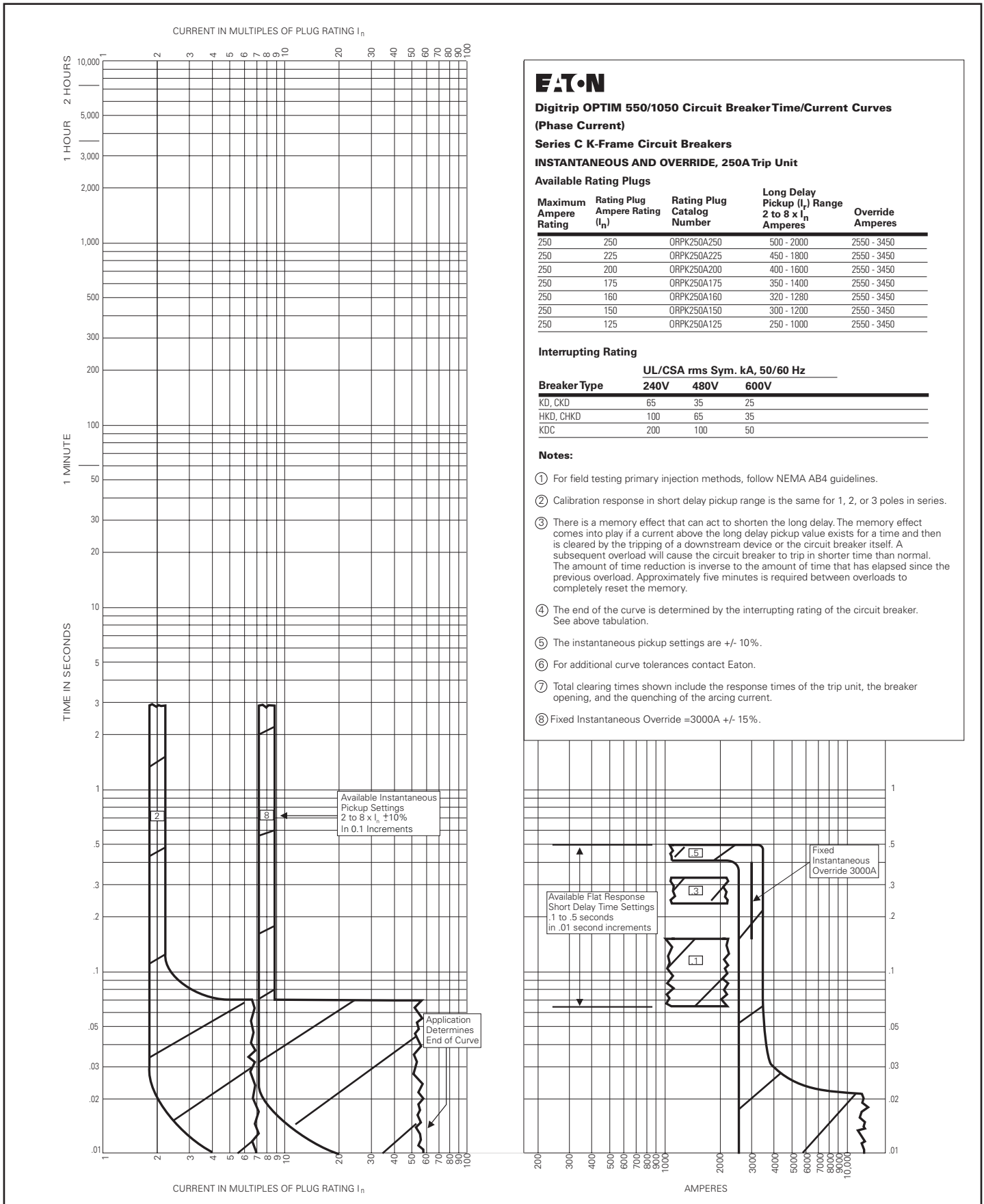

Figure 21. Digitrip Optim Instantaneous and Override, 250A Trip Unit - Curve Number SC-6928-98, May 1998

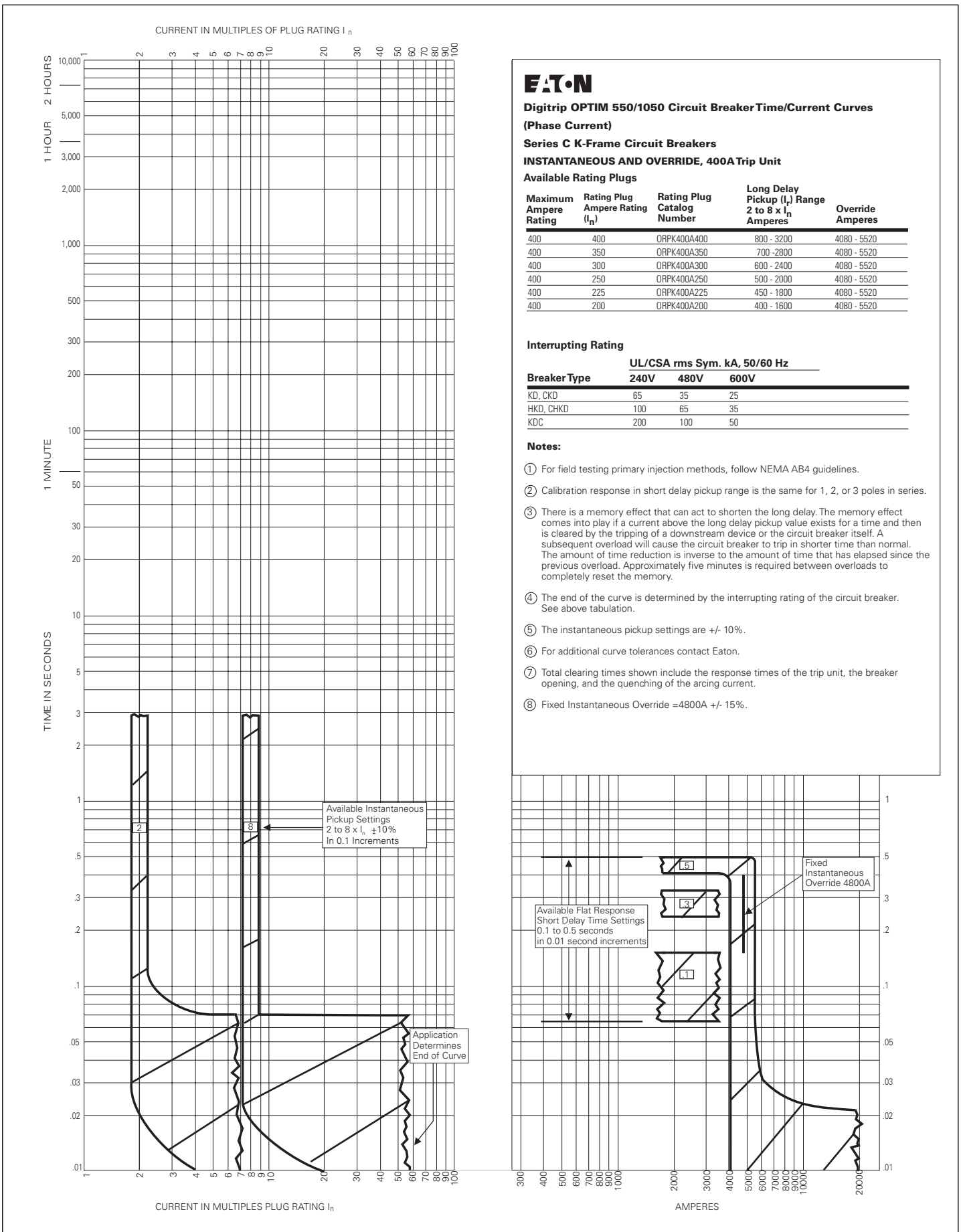

Figure 22. Digitrip Optim Instantaneous and Override, 400A Trip Unit - Curve Number SC-6929-98, May 1998

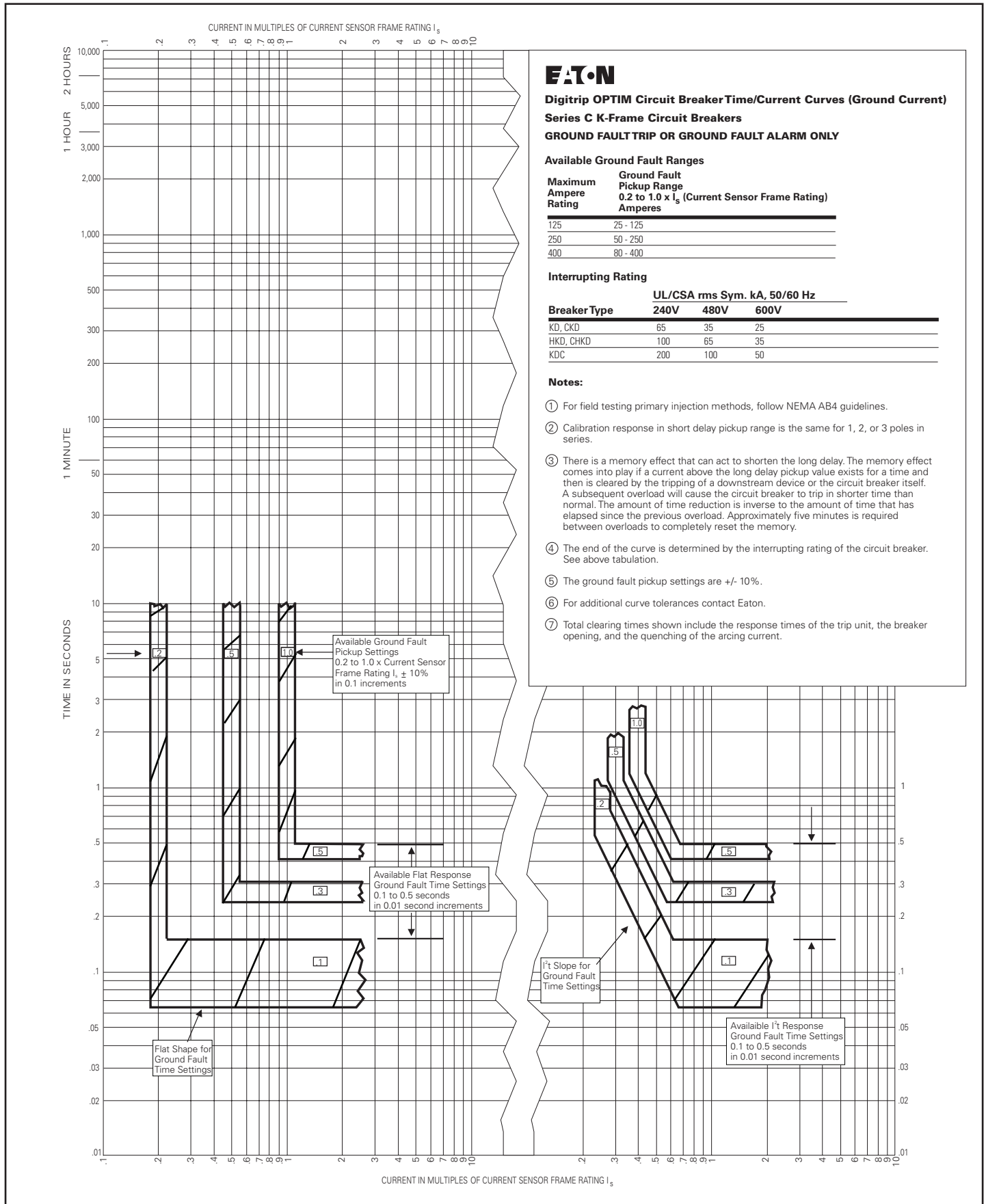

Figure 23. Digitrip Optim Ground Fault Trip or Ground Fault Alarm Only - Curve Number SC-6930-98, May 1998

- Legacy Product -

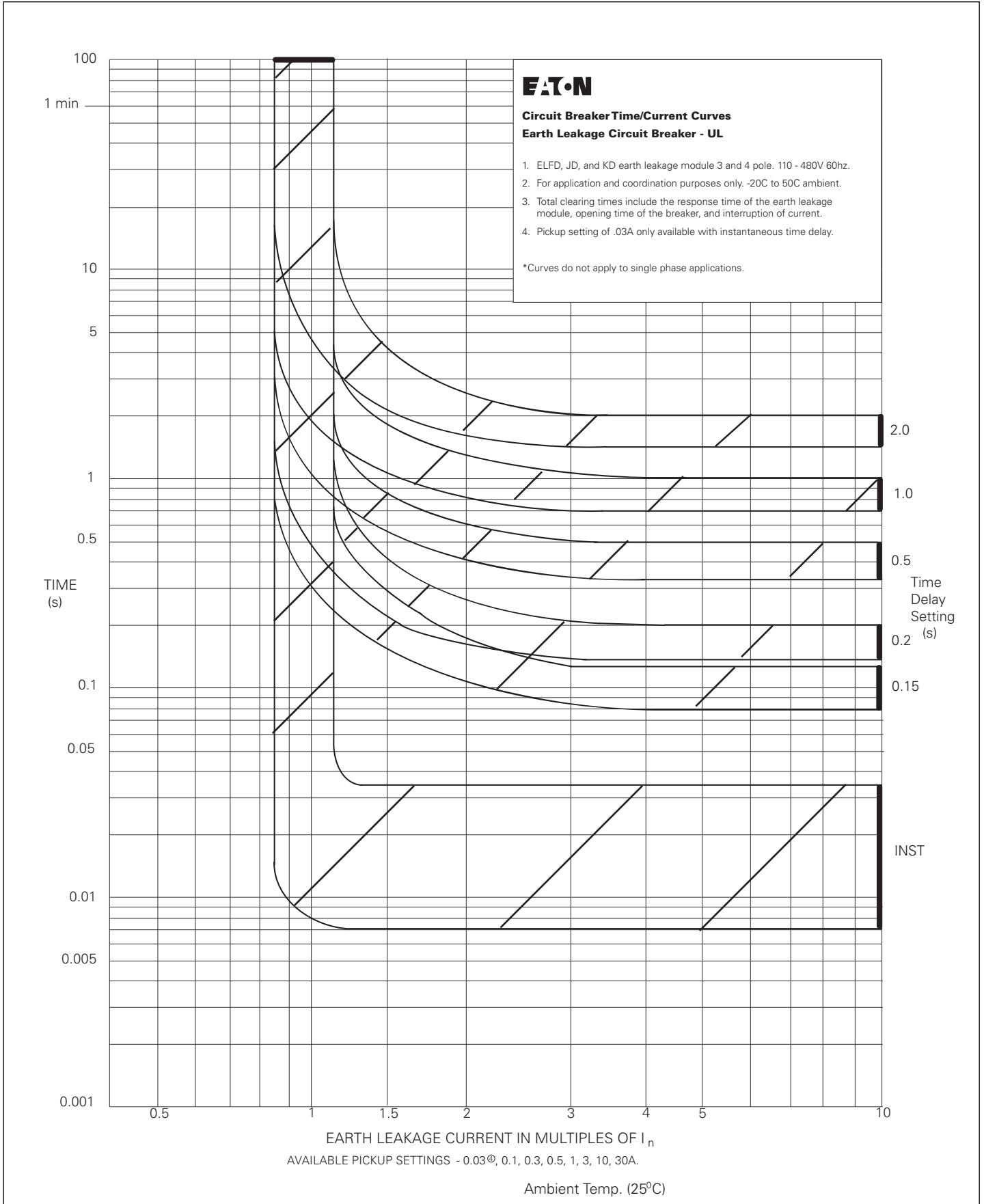

Figure 24. UL Series C K-Frame Circuit breaker Earth Leakage Module, 110-480V - Curve Number TC01212005E, March 2003

- Legacy Product -

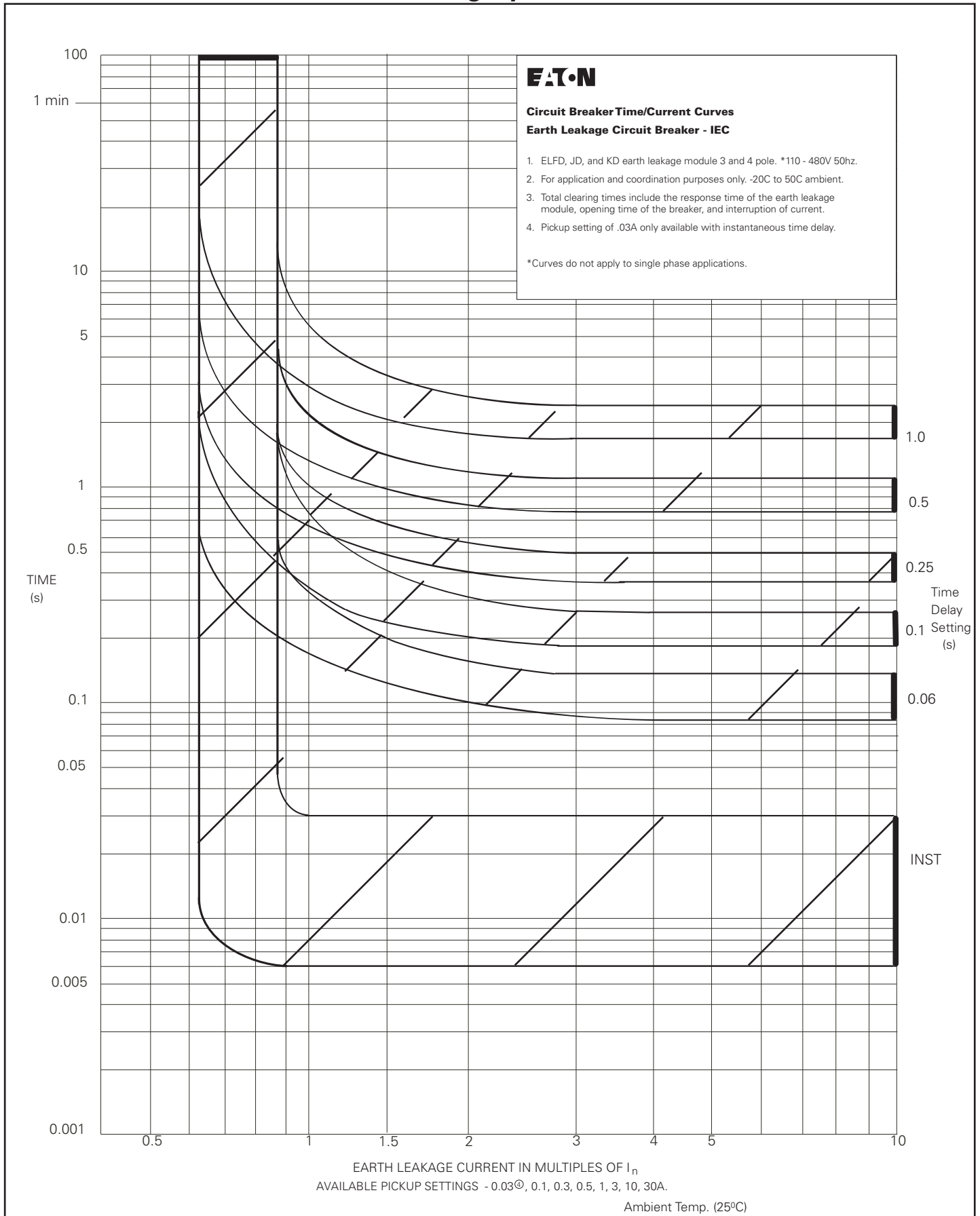
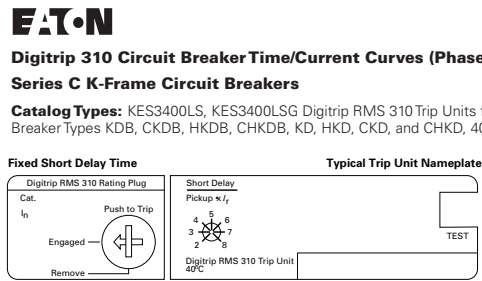
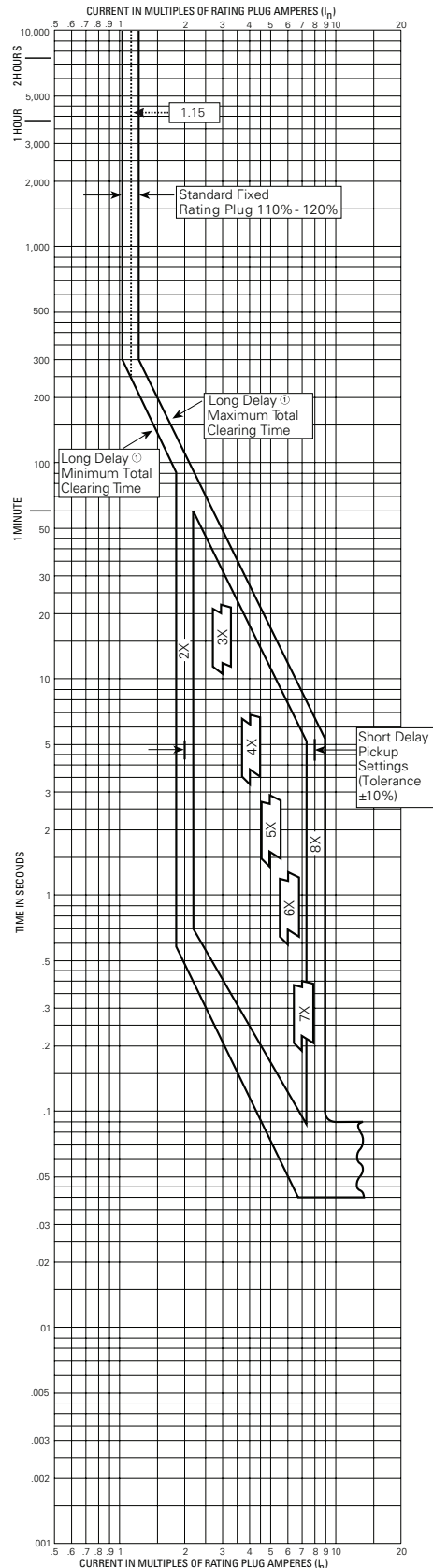

Figure 25. IEC Series C K-Frame Circuit breaker Earth Leakage Module, 110-480V - Curve Number TC01212006E, March 2003

- Legacy Product -



Available Rating Plugs

Ampere Rating (I _n)	Type	Catalog Number	Short Delay Pickup Range Amperes
400	Fixed	4KES 400T	800 - 3200
350	Fixed	4KES 350T	700 - 2800
300	Fixed	4KES 300T	600 - 2400
250	Fixed	4KES 250T	500 - 2000
225	Fixed	4KES 225T	450 - 1800
200	Fixed	4KES 200T	400 - 1600
200, 250, 300, 400	Adjustable	A4KES 400T1	400 - 3200
250, 300, 350, 400	Adjustable	A4KES 400T3	500 - 3200

Interrupting Rating UL/CSA rms Sym. kA, 50/60 Hz

Breaker Type	240V	480V	600V
KD, CKD, KDB, CKDB	65	35	25
HKD, CHKD, HKDB, CHKDB	100	65	35

IEC 60947-2 rms Sym. kA, 50/60 Hz

Breaker Type	240V	380V	415V
KD, CKD, KDB, CKDB	65	40	40
HKD, CHKD, HKDB, CHKDB	100	65	65

Notes:
 I_r = Continuous Current Setting or Rating Plug Value, I_g = Current Sensor Frame Rating,
 I_n = Rating Plug Value, I_g = Unit of Ground Current, I_i = Instantaneous Override Pickup.

Digitrip RMS 310 trip units are suitable for functional field testing with test kit Cat. No. STK2. For field testing using primary injection methods, follow NEMA publication AB-4.

There is a memory effect that can act to shorten the long delay. The memory effect comes into play if a current above the long delay pickup value exists for a time and then is cleared by the tripping of a downstream device or the circuit breaker itself. A subsequent overload will cause the circuit breaker to trip in shorter time than normal. The amount of time delay reduction is inverse to the amount of time that has elapsed since the previous overload. Approximately five minutes is required between overloads to completely reset the memory.

- ① Curve accuracy applies from -20°C to +55°C ambient. For possible continuous ampere derating for ambient above 40°C, refer to Eaton.
- ② For high fault current levels, a fixed instantaneous override is provided at 4000A (Tolerance ±15%).
- ③ The end of the curve is determined by the interrupting rating of the circuit breaker. See above tabulation.
- ④ Long Delay Pickup is 115% of I_n, +/- 5%.

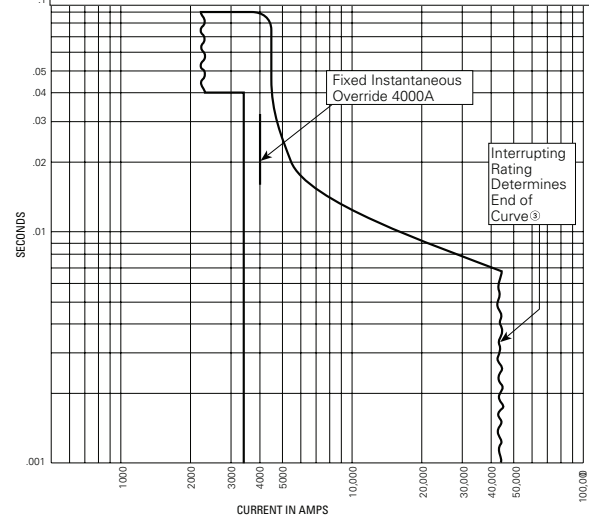

Figure 26. Series C Types KD, CKD, HKD, CHKD Circuit Breakers Equipped with Type KES Digitrip RMS 310 Trip Units, Types KES3400LS, KES3400LSG



Digitrip 310 Circuit Breaker Time/Current Curves (Phase Current)

Series C K-Frame Circuit Breakers

Catalog Types: KES3400LSI, KES3400LSIG Digitrip RMS 310 Units for use with Circuit Breaker Types KD, HKD, CKD, and CHKD, 400A. max.

Fixed Short Delay Time

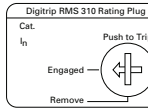

Short Delay

Pickup $\times I_r$

4 5 6

3 7

2 8

Digitrip RMS 310 Trip Unit

40°C

Typical Trip Unit Nameplate

TEST

Available Rating Plugs

Ampere Rating (I_n)	Type	Catalog Number	Short Delay Pickup Range Amperes
400	Fixed	4KES 400T	800 - 3200
350	Fixed	4KES 350T	700 - 2800
300	Fixed	4KES 300T	600 - 2400
250	Fixed	4KES 250T	500 - 2000
225	Fixed	4KES 225T	450 - 1800
200	Fixed	4KES 200T	400 - 1600
200, 250, 300, 400	Adjustable	A4KES 400T1	400 - 3200
250, 300, 350, 400	Adjustable	A4KES 400T3	500 - 3200

Interrupting Rating

Breaker Type	UL/CSA rms Sym. kA, 50/60 Hz		
	240V	480V	600V
KD, CKD	65	35	25
HKD, CHKD	100	65	35

Breaker Type	IEC 60947-2 rms Sym. kA, 50/60 Hz		
	240V	380V	415V
KD, CKD	65	40	40
HKD, CHKD	100	65	65

Notes:

I_r = Continuous Current Setting or Rating Plug Value, I_s = Current Sensor Frame Rating, I_n = Rating Plug Value, I_g = Unit of Ground Current, I_1 = Instantaneous Override Pickup.

Digitrip RMS 310 trip units are suitable for functional field testing with test kit Cat. No. STK2. For field testing using primary injection methods, follow NEMA publication AB-4.

There is a memory effect that can act to shorten the long delay. The memory effect comes into play if a current above the long delay pickup value exists for a time and then is cleared by the tripping of a downstream device or the circuit breaker itself. A subsequent overload will cause the circuit breaker to trip in shorter time than normal. The amount of time delay reduction is inverse to the amount of time that has elapsed since the previous overload. Approximately five minutes is required between overloads to completely reset the memory.

- Curve accuracy applies from -20°C to +55°C ambient. For possible continuous ampere derating for ambient above 40°C, refer to Eaton.
- For high fault current levels, a fixed instantaneous override is provided at 4000A (Tolerance $\pm 15\%$).
- The end of the curve is determined by the interrupting rating of the circuit breaker. See above tabulation.
- Long Delay Pickup is 115% of I_n , $\pm 5\%$.

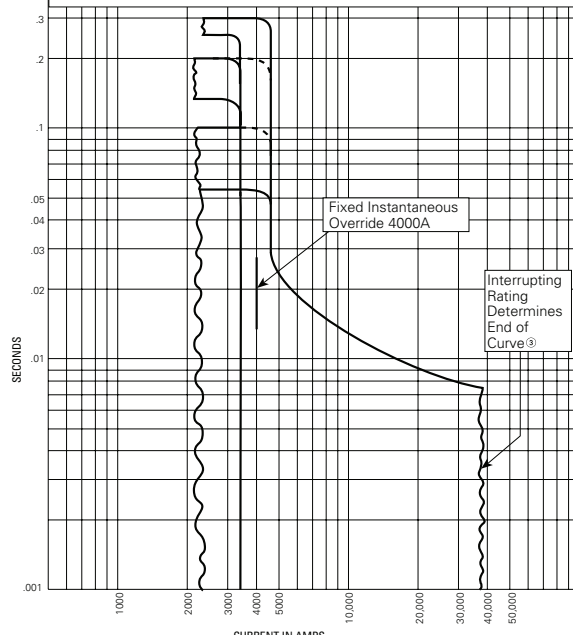
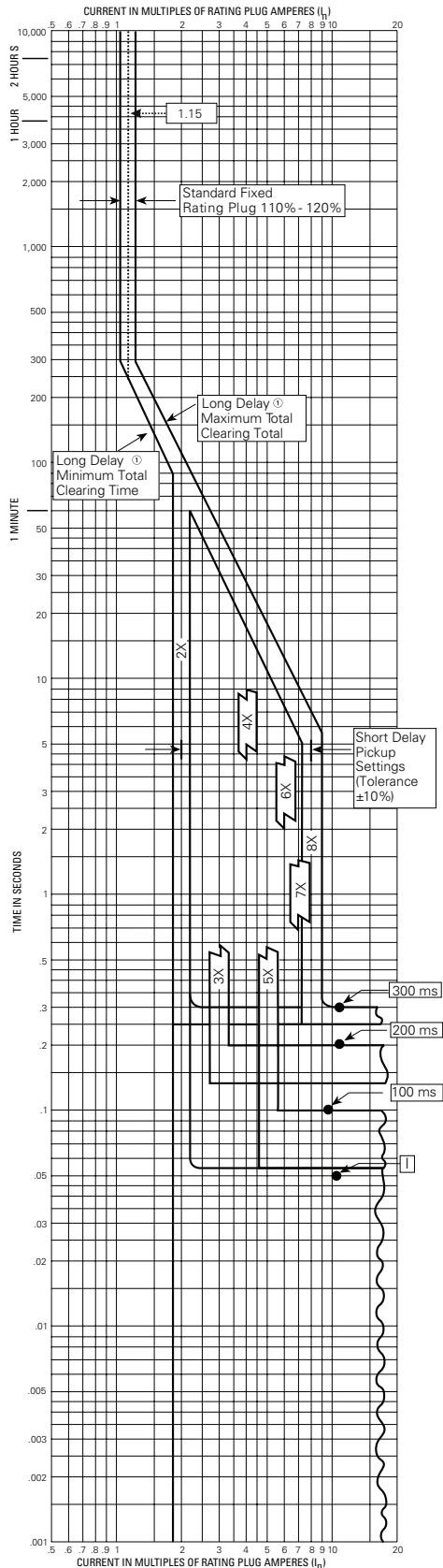
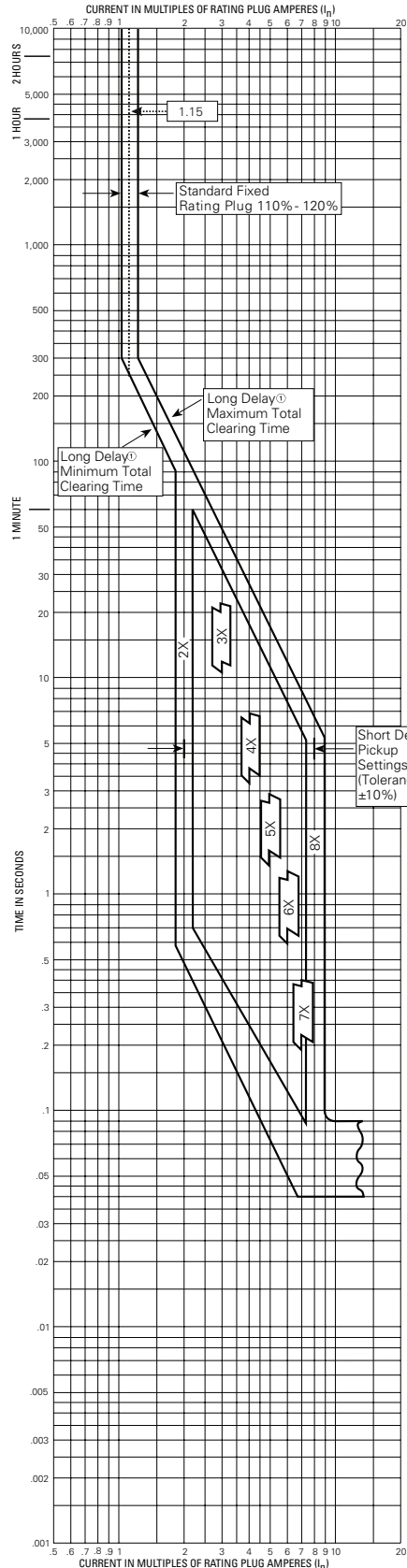

Figure 27. Series C Types KD, CKD, HKD, CHKD Circuit Breakers Equipped with Type KES Digitrip RMS 310 Trip Units, Types KES3400LSI, KES3400LSIG

- Legacy Product -



Digitrip 310 Circuit Breaker Time/Current Curves (Phase Current)
Series C K-Frame Circuit Breakers

Catalog Types: KES3250LS, KES3250LSG Digitrip RMS 310 Units for use with Circuit Breaker Types KDB, CKDB, HKDB, CHKDB, KD, HKD, CKD, and CHKD, 250A. max.

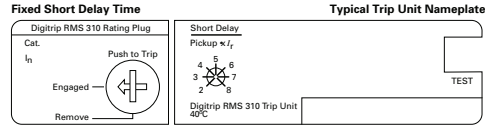

Available Rating Plugs

Ampere Rating (I_n)	Type	Catalog Number	Short Delay Pickup Range Amperes
250	Fixed	2KES 250T	250 - 1000
225	Fixed	2KES 225T	220 - 880
200	Fixed	2KES 200T	200 - 800
175	Fixed	2KES 175T	180 - 720
150	Fixed	2KES 150T	140 - 560
125	Fixed	2KES 125T	250 - 1000
125, 150, 200, 250	Adjustable	A2KES 250T1	250 - 2000

Interrupting Rating

Breaker Type	UL/CSA rms Sym. kA, 50/60 Hz		
	240V	480V	600V
KD, CKD, KDB, CKDB	65	35	25
HKD, CHKD, HKDB, CHKDB	100	65	35

Breaker Type	IEC 60947-2 rms Sym. kA, 50/60 Hz		
	240V	380V	415V
KD, CKD, KDB, CKDB	65	40	40
HKD, CHKD, HKDB, CHKDB	100	65	65

Notes:

I_r = Continuous Current Setting or Rating Plug Value, I_s = Current Sensor Frame Rating, I_g = Rating Plug Value, I_g = Unit of Ground Current, I_o = Instantaneous Override Pickup.

Digitrip RMS 310 trip units are suitable for functional field testing with test kit Cat. No. STK2. For field testing using primary injection methods, follow NEMA publication AB-4.

There is a memory effect that can act to shorten the long delay. The memory effect comes into play if a current above the long delay pickup value exists for a time and then is cleared by the tripping of a downstream device or the circuit breaker itself. A subsequent overload will cause the circuit breaker to trip in shorter time than normal. The amount of time delay reduction is inverse to the amount of time that has elapsed since the previous overload. Approximately five minutes is required between overloads to completely reset the memory.

- Curve accuracy applies from -20°C to +55°C ambient. For possible continuous ampere derating for ambient above 40°C, refer to Eaton.
- For high fault current levels, a fixed instantaneous override is provided at 4000A (Tolerance ±15%).
- The end of the curve is determined by the interrupting rating of the circuit breaker. See above tabulation.
- Long Delay Pickup is 115% of I_n , +/- 5%.

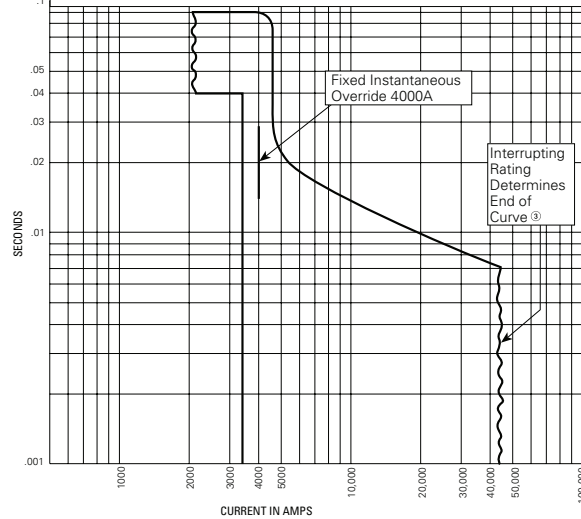

Figure 28. Series C Types KD, CKD, HKD, CHKD Circuit Breakers Equipped with Type KES Digitrip RMS 310 Trip Units, Types KES3250LS, KES3250LSG



Digitrip 310 Circuit Breaker Time/Current Curves (Phase Current)
Series C K-Frame Circuit Breakers

Catalog Types: KES3250LSI, KES3250LSIG Digitrip RMS 310 Units for use with Circuit Breaker Types KDB, CKDB, HKDB, CHKDB, KD, HKD, CKD, and CHKD, 250A. max.

Adjustable Short Delay Time

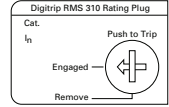

Typical Trip Unit Nameplate

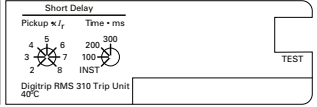

Available Rating Plugs

Ampere Rating (I_n)	Type	Catalog Number	Short Delay Pickup Range Amperes
250	Fixed	2KES 250T	500 - 2000
225	Fixed	2KES 225T	450 - 1800
200	Fixed	2KES 200T	400 - 1600
175	Fixed	2KES 175T	350 - 1400
150	Fixed	2KES 150T	300 - 1200
125	Fixed	2KES 125T	250 - 1000
125, 150, 200, 250	Adjustable	A2KES 250T1	250 - 2000

Interrupting Rating

Breaker Type	UL/CSA rms Sym. kA, 50/60 Hz		
	240V	480V	600V
KD, CKD, KDB, CKDB	65	35	25
HKD, CHKD, HKDB, CHKDB	100	65	35

Breaker Type	IEC 60947-2 rms Sym. kA, 50/60 Hz		
	240V	380V	415V
KD, CKD, KDB, CKDB	65	40	40
HKD, CHKD, HKDB, CHKDB	100	65	65

Notes:

- I_r = Continuous Current Setting or Rating Plug Value, I_s = Current Sensor Frame Rating, I_n = Rating Plug Value, I_g = Unit of Ground Current, I_t = Instantaneous Override Pickup.
- Digitrip RMS 310 trip units are suitable for functional field testing with test kit Cat. No. STK2. For field testing using primary injection methods, follow NEMA publication AB-4.

There is a memory effect that can act to shorten the long delay. The memory effect comes into play if a current above the long delay pickup value exists for a time and then is cleared by the tripping of a downstream device or the circuit breaker itself. A subsequent overload will cause the circuit breaker to trip in shorter time than normal. The amount of time delay reduction is inverse to the amount of time that has elapsed since the previous overload. Approximately five minutes is required between overloads to completely reset the memory.

- Curve accuracy applies from -20°C to $+55^{\circ}\text{C}$ ambient. For possible continuous ampere derating for ambient above 40°C , refer to Eaton.
- For high fault current levels, a fixed instantaneous override is provided at 4000A (Tolerance $\pm 15\%$).
- The end of the curve is determined by the interrupting rating of the circuit breaker. See above tabulation.
- Long Delay Pickup is 115% of I_n , $\pm 5\%$.

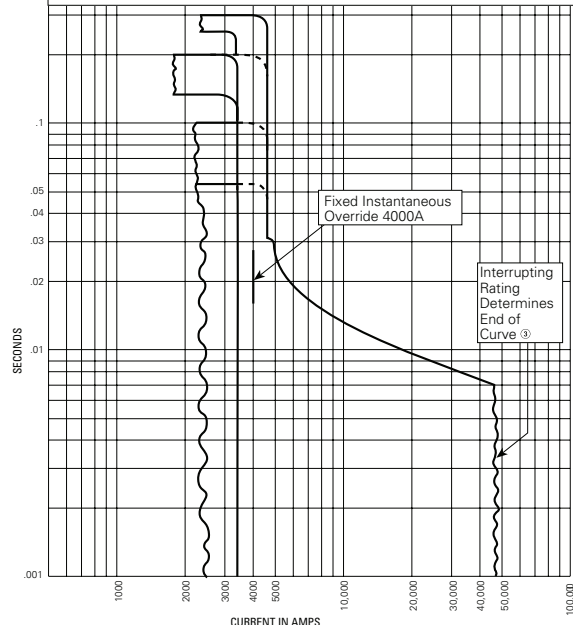
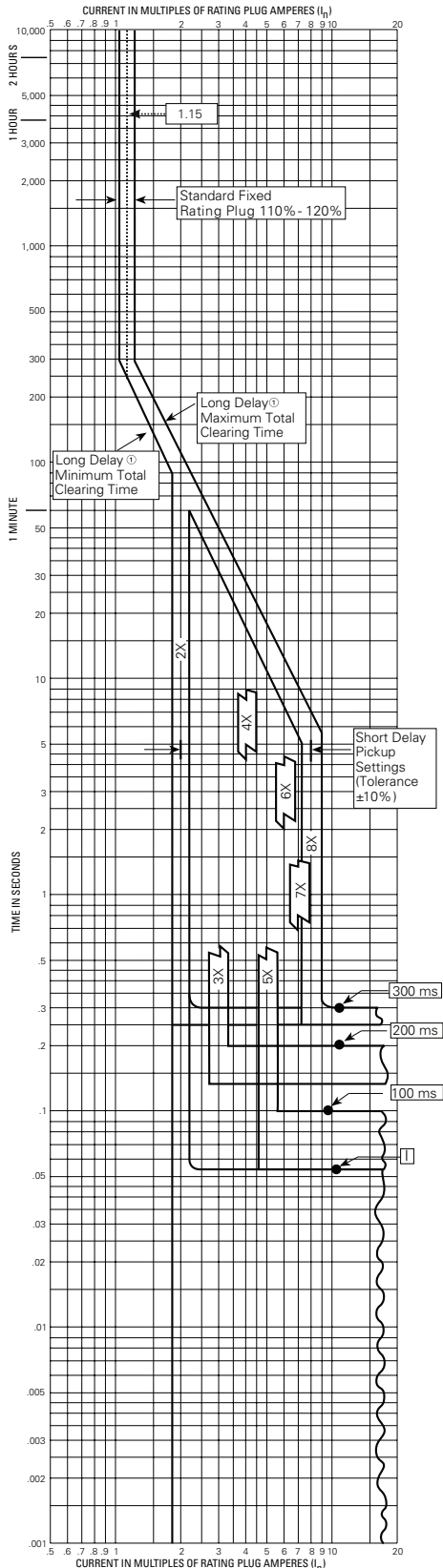
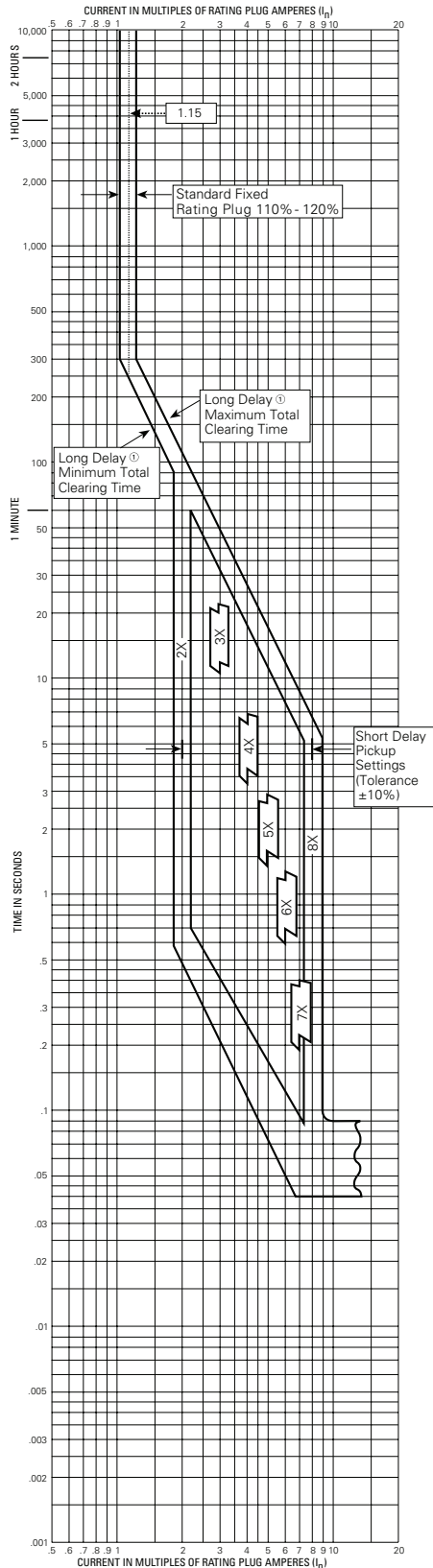

Figure 29. Series C Types KD, CKD, HKD, CHKD Circuit Breakers Equipped with Type KES Digitrip RMS 310 Trip Units, Types KES3250LSI, KES3250LSIG

- Legacy Product -



Digitrip 310 Circuit Breaker Time/Current Curves (Phase Current)
Series C K-Frame Circuit Breakers

Catalog Types: KES3125LS, KES3125LSG Digitrip RMS 310 Trip Units for use with Circuit Breaker Types: KDB, HKDB, CKDB, CHKDB, KD, HKD, CKD, and CHKD, 125A. max.

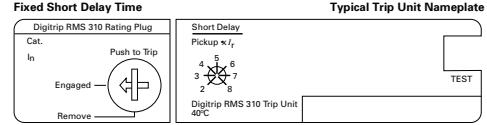

Available Rating Plugs

Ampere Rating (I_n)	Type	Catalog Number	Short Delay Pickup Range Amperes
125	Fixed	1KES 125T	250 - 1000
110	Fixed	1KES 110T	220 - 880
100	Fixed	1KES 100T	200 - 800
90	Fixed	1KES 90T	180 - 720
70	Fixed	1KES 70T	140 - 560
70, 90, 100, 125	Adjustable	A1KES 125T1	140- 1000

Interrupting Rating

Breaker Type	UL/CSA rms Sym. kA, 50/60 Hz		
	240V	480V	600V
KD, CKD, KDB, CKDB	65	35	25
HKD, CHKD, HKDB, CHKDB	100	65	35

Breaker Type	IEC 60947-2 rms Sym. kA, 50/60 Hz		
	240V	380V	415V
KD, CKD, KDB, CKDB	65	40	40
HKD, CHKD, HKDB, CHKDB	100	65	65
KDC	200	100	50

Notes:

I_r = Continuous Current Setting or Rating Plug Value, I_g = Current Sensor Frame Rating, I_n = Rating Plug Value, I_g = Unit of Ground Current, I_i = Instantaneous Override Pickup.

Digitrip RMS 310 trip units are suitable for functional field testing with test kit Cat. No. STK2. For field testing using primary injection methods, follow NEMA publication AB-4.

There is a memory effect that can act to shorten the long delay. The memory effect comes into play if a current above the long delay pickup value exists for a time and then is cleared by the tripping of a downstream device or the circuit breaker itself. A subsequent overload will cause the circuit breaker to trip in shorter time than normal. The amount of time delay reduction is inverse to the amount of time that has elapsed since the previous overload. Approximately five minutes is required between overloads to completely reset the memory.

- Curve accuracy applies from -20°C to $+55^{\circ}\text{C}$ ambient. For possible continuous ampere derating for ambient above 40°C , refer to Eaton.
- For high fault current levels, a fixed instantaneous override is provided at 3000A (Tolerance $\pm 15\%$).
- The end of the curve is determined by the interrupting rating of the circuit breaker. See above tabulation.
- Long Delay Pickup is 115% of I_n , $\pm 5\%$.

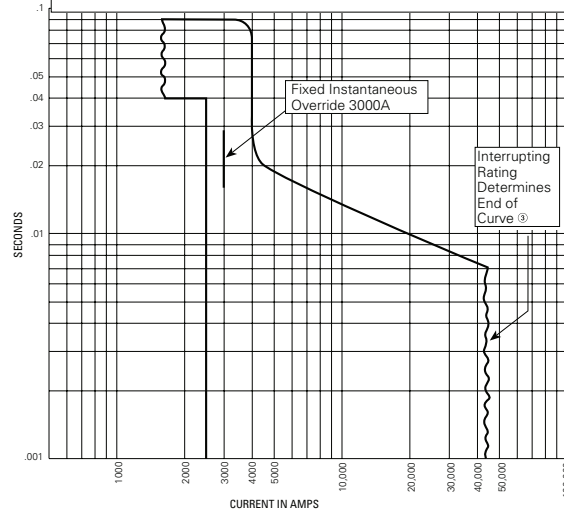

Figure 30. Series C Types KD, CKD, HKD, CHKD Circuit Breakers Equipped with Type KES Digitrip RMS 310 Trip Units, Types KES3125LS, KES3125LSG

- Legacy Product -



Digitrip 310 Circuit Breaker Time/Current Curves (Phase Current)
Series C K-Frame Circuit Breakers

Catalog Types: KES3125LSI, KES3125LSIG Digitrip RMS 310 Trip Units for use with Circuit Breaker Types KDB, CKDB, HKDB, CHKDB, KD, HKD, CKD, and CHKD, 125A. max.

Adjustable Short Delay Time

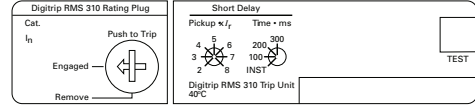

Available Rating Plugs

Ampere Rating (I_n)	Type	Catalog Number	Short Delay Pickup Range Amperes
125	Fixed	1KES 125T	250 - 1000
110	Fixed	1KES 110T	220 - 880
100	Fixed	1KES 100T	200 - 800
90	Fixed	1KES 90T	180 - 720
70	Fixed	1KES 70T	140 - 560
70, 90, 100, 125	Adjustable	A1KES 125T1	140 - 1000

Interrupting Rating

Breaker Type	UL/CSA rms Sym. kA, 50/60 Hz		
	240V	480V	600V
KD, CKD, KDB, CKDB	65	35	25
HKD, CHKD, HKDB, CHKDB	100	65	35

Breaker Type	IEC 60947-2 rms Sym. kA, 50/60 Hz		
	240V	380V	415V
KD, CKD, KDB, CKDB	65	40	40
HKD, CHKD, HKDB, CHKDB	100	65	65

Notes:

I_r = Continuous Current Setting or Rating Plug Value, I_s = Current Sensor Frame Rating, I_n = Rating Plug Value, I_g = Unit of Ground Current, I_i = Instantaneous Override Pickup.

Digitrip RMS 310 trip units are suitable for functional field testing with test kit Cat. No. STK2. For field testing using primary injection methods, follow NEMA publication AB-4.

There is a memory effect that can act to shorten the long delay. The memory effect comes into play if a current above the long delay pickup value exists for a time and then is cleared by the tripping of a downstream device or the circuit breaker itself. A subsequent overload will cause the circuit breaker to trip in shorter time than normal. The amount of time delay reduction is inverse to the amount of time that has elapsed since the previous overload. Approximately five minutes is required between overloads to completely reset the memory.

- Curve accuracy applies from -20°C to $+55^{\circ}\text{C}$ ambient. For possible continuous ampere derating for ambient above 40°C , refer to Eaton.
- For high fault current levels, a fixed instantaneous override is provided at 3000A (Tolerance $\pm 15\%$).
- The end of the curve is determined by the interrupting rating of the circuit breaker. See above tabulation.
- Long Delay Pickup is 115% of I_n , $\pm 5\%$.

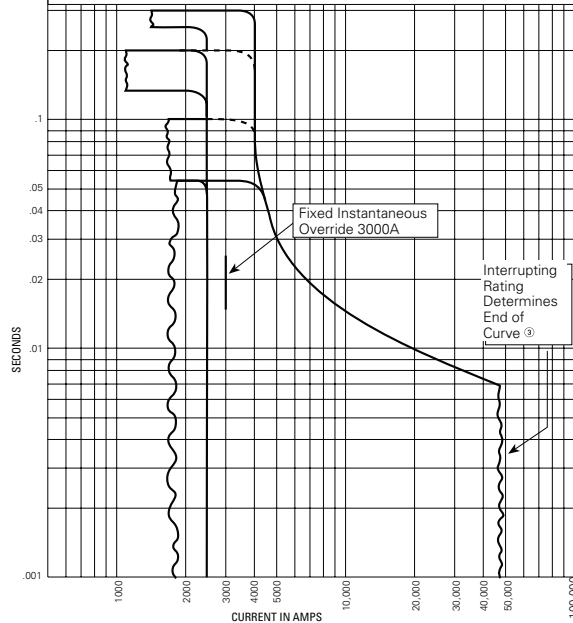
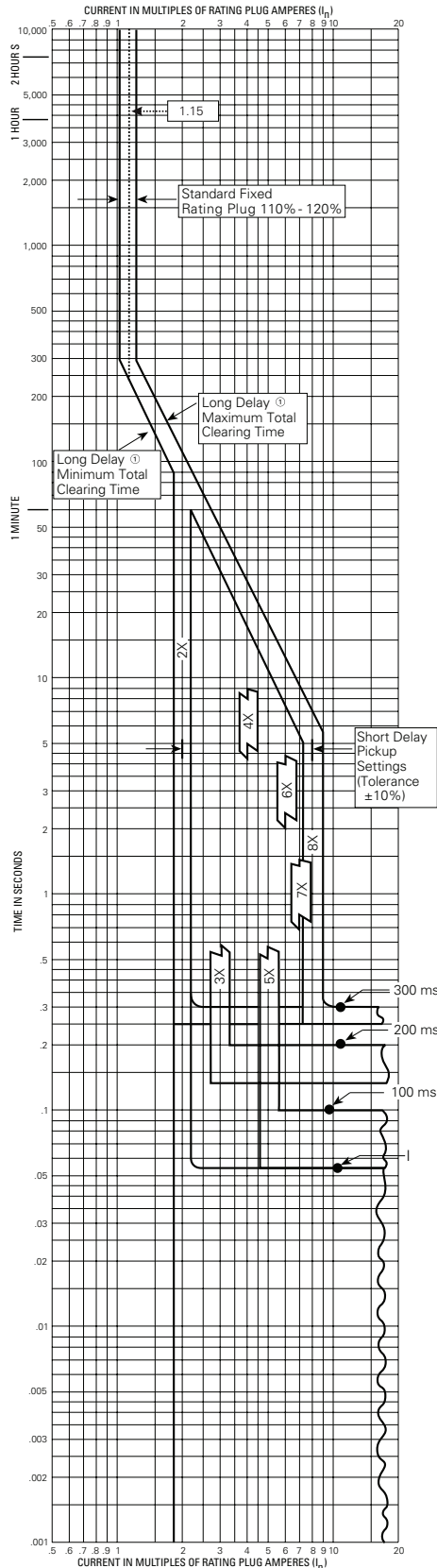
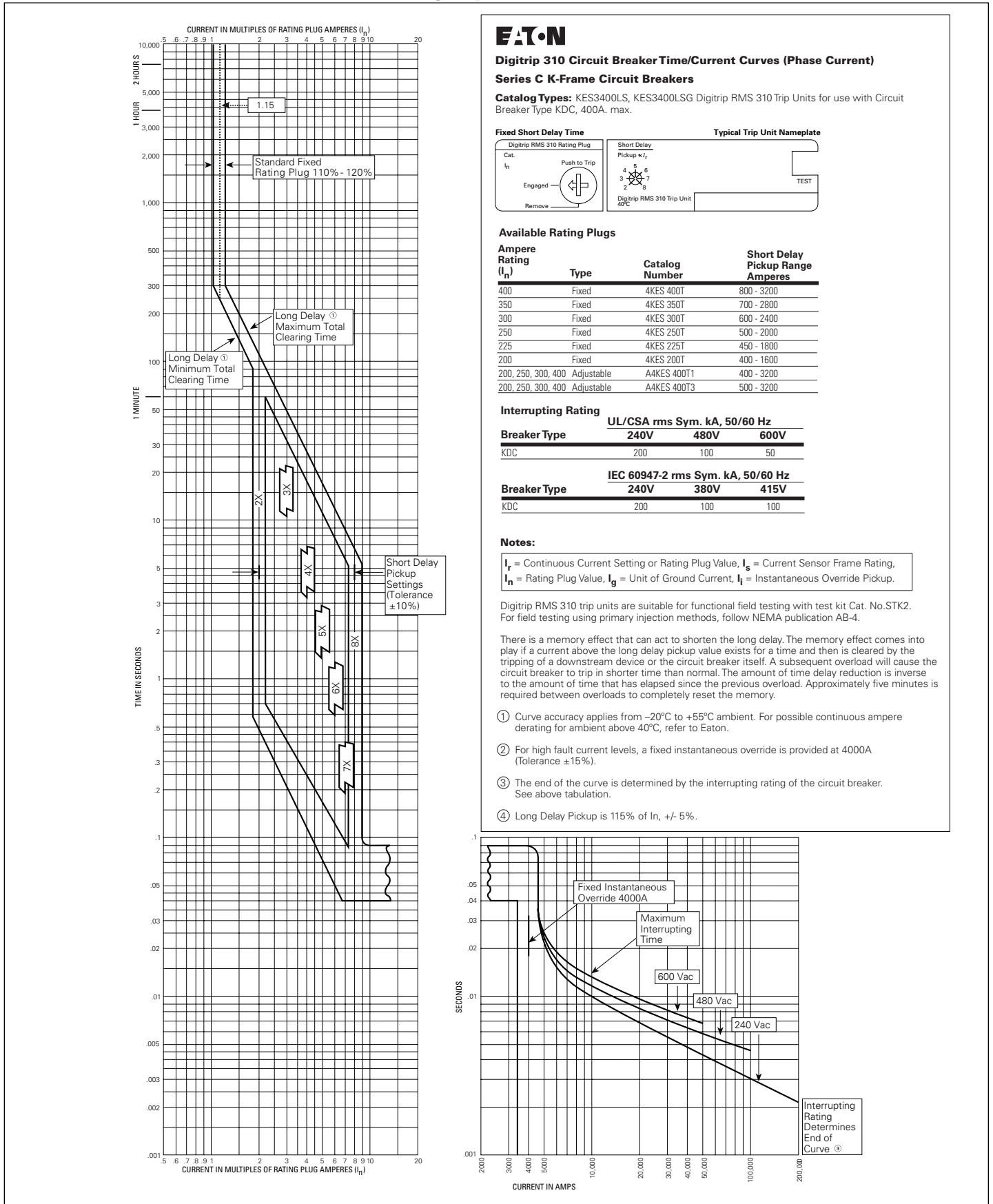

Figure 31. Series C Types KD, CKD, HKD, CHKD Circuit Breakers Equipped with Type KES Digitrip RMS 310 Trip Units, Types KES3125LSI, KES3125LSIG

- Legacy Product -



Digitrip 310 Circuit Breaker Time/Current Curves (Phase Current)

Series C K-Frame Circuit Breakers

Catalog Types: KES3400LS, KES3400LSG Digitrip RMS 310 Trip Units for use with Circuit Breaker Type KDC, 400A. max.

Fixed Short Delay Time

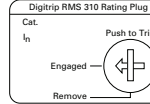

Typical Trip Unit Nameplate



Available Rating Plugs

Ampere Rating (I_n)	Type	Catalog Number	Short Delay Pickup Range Amperes
400	Fixed	4KES 400T	800 - 3200
350	Fixed	4KES 350T	700 - 2800
300	Fixed	4KES 300T	600 - 2400
250	Fixed	4KES 250T	500 - 2000
225	Fixed	4KES 225T	450 - 1800
200	Fixed	4KES 200T	400 - 1600
200, 250, 300, 400	Adjustable	A4KES 400T1	400 - 3200
200, 250, 300, 400	Adjustable	A4KES 400T3	500 - 3200

Interrupting Rating

UL/CSA rms Sym. kA, 50/60 Hz

Breaker Type	240V	480V	600V
KDC	200	100	50

IEC 60947-2 rms Sym. kA, 50/60 Hz

Breaker Type	240V	380V	415V
KDC	200	100	100

Notes:

I_r = Continuous Current Setting or Rating Plug Value, I_s = Current Sensor Frame Rating, I_n = Rating Plug Value, I_g = Unit of Ground Current, I_i = Instantaneous Override Pickup.

Digitrip RMS 310 trip units are suitable for functional field testing with test kit Cat. No. STK2. For field testing using primary injection methods, follow NEMA publication AB-4.

There is a memory effect that can act to shorten the long delay. The memory effect comes into play if a current above the long delay pickup value exists for a time and then is cleared by the tripping of a downstream device or the circuit breaker itself. A subsequent overload will cause the circuit breaker to trip in shorter time than normal. The amount of time delay reduction is inverse to the amount of time that has elapsed since the previous overload. Approximately five minutes is required between overloads to completely reset the memory.

- Curve accuracy applies from -20°C to $+55^{\circ}\text{C}$ ambient. For possible continuous ampere derating for ambient above 40°C , refer to Eaton.
- For high fault current levels, a fixed instantaneous override is provided at 4000A (Tolerance $\pm 15\%$).
- The end of the curve is determined by the interrupting rating of the circuit breaker. See above tabulation.
- Long Delay Pickup is 115% of I_n , $\pm 5\%$.

Figure 32. Series C Type KDC Circuit Breakers Equipped with Type KES Digitrip RMS 310 Trip Units, Types KES3400LS, KES3400LSG



Digitrip 310 Circuit Breaker Time/Current Curves (Phase Current)

Series C K-Frame Circuit Breakers

Catalog Types: KES3400LSI, KES3400LSIG, Digitrip RMS 310 Trip Units for use with Circuit Breaker Type KDC, 400A. max.

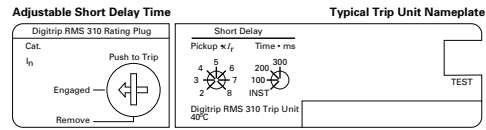

Available Rating Plugs

Ampere Rating (I_n)	Type	Catalog Number	Short Delay Pickup Range Amperes
400	Fixed	4KES 400T	800 - 3200
350	Fixed	4KES 350T	700 - 2800
300	Fixed	4KES 300T	600 - 2400
250	Fixed	4KES 250T	500 - 2000
225	Fixed	4KES 225T	450 - 1800
200	Fixed	4KES 200T	400 - 1600
200, 250, 300, 400	Adjustable	A4KES 400T1	400 - 3200
200, 250, 300, 400	Adjustable	A4KES 400T3	500 - 3200

Interrupting Rating

Breaker Type	UL/CSA rms Sym. kA, 50/60 Hz		
	240V	480V	600V
KDC	200	100	50

Breaker Type	IEC 60947-2 rms Sym. kA, 50/60 Hz		
	240V	380V	415V
KDC	200	100	100

Notes:

I_p = Continuous Current Setting or Rating Plug Value, I_s = Current Sensor Frame Rating,
 I_n = Rating Plug Value, I_g = Unit of Ground Current, I_i = Instantaneous Override Pickup.

Digitrip RMS 310 trip units are suitable for functional field testing with test kit Cat. No. STK2. For field testing using primary injection methods, follow NEMA publication AB-4.

There is a memory effect that can act to shorten the long delay. The memory effect comes into play if a current above the long delay pickup value exists for a time and then is cleared by the tripping of a downstream device or the circuit breaker itself. A subsequent overload will cause the circuit breaker to trip in shorter time than normal. The amount of time delay reduction is inverse to the amount of time that has elapsed since the previous overload. Approximately five minutes is required between overloads to completely reset the memory.

- Curve accuracy applies from -20°C to $+55^{\circ}\text{C}$ ambient. For possible continuous ampere derating for ambient above 40°C , refer to Eaton.
- For high fault current levels, a fixed instantaneous override is provided at 4000A (Tolerance $\pm 15\%$).
- The end of the curve is determined by the interrupting rating of the circuit breaker. See above tabulation.
- Long Delay Pickup is 115% of I_n , $\pm 5\%$.

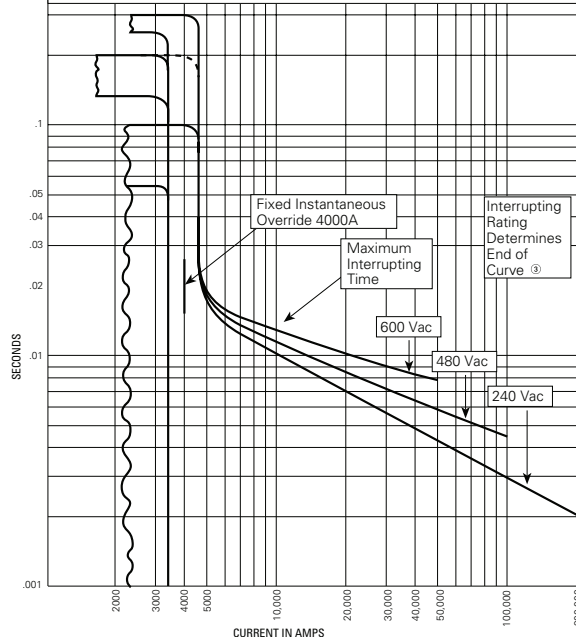
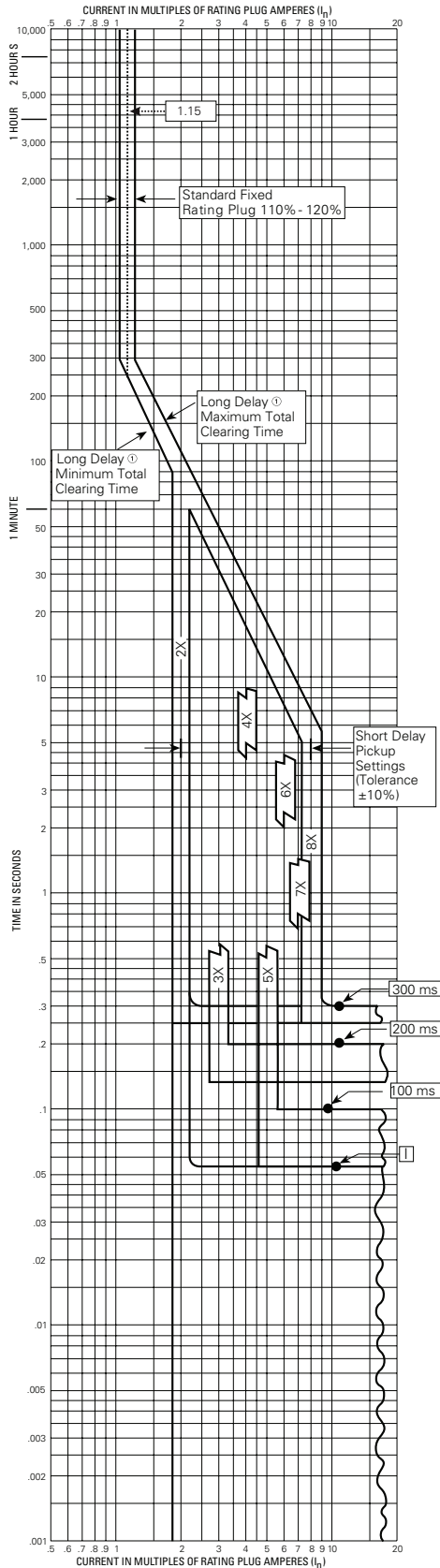

Figure 33. Series C Type KDC Circuit Breakers Equipped with Type KES Digitrip RMS 310 Trip Units, Types KES3400LSI, KES3400LSIG

- Legacy Product -

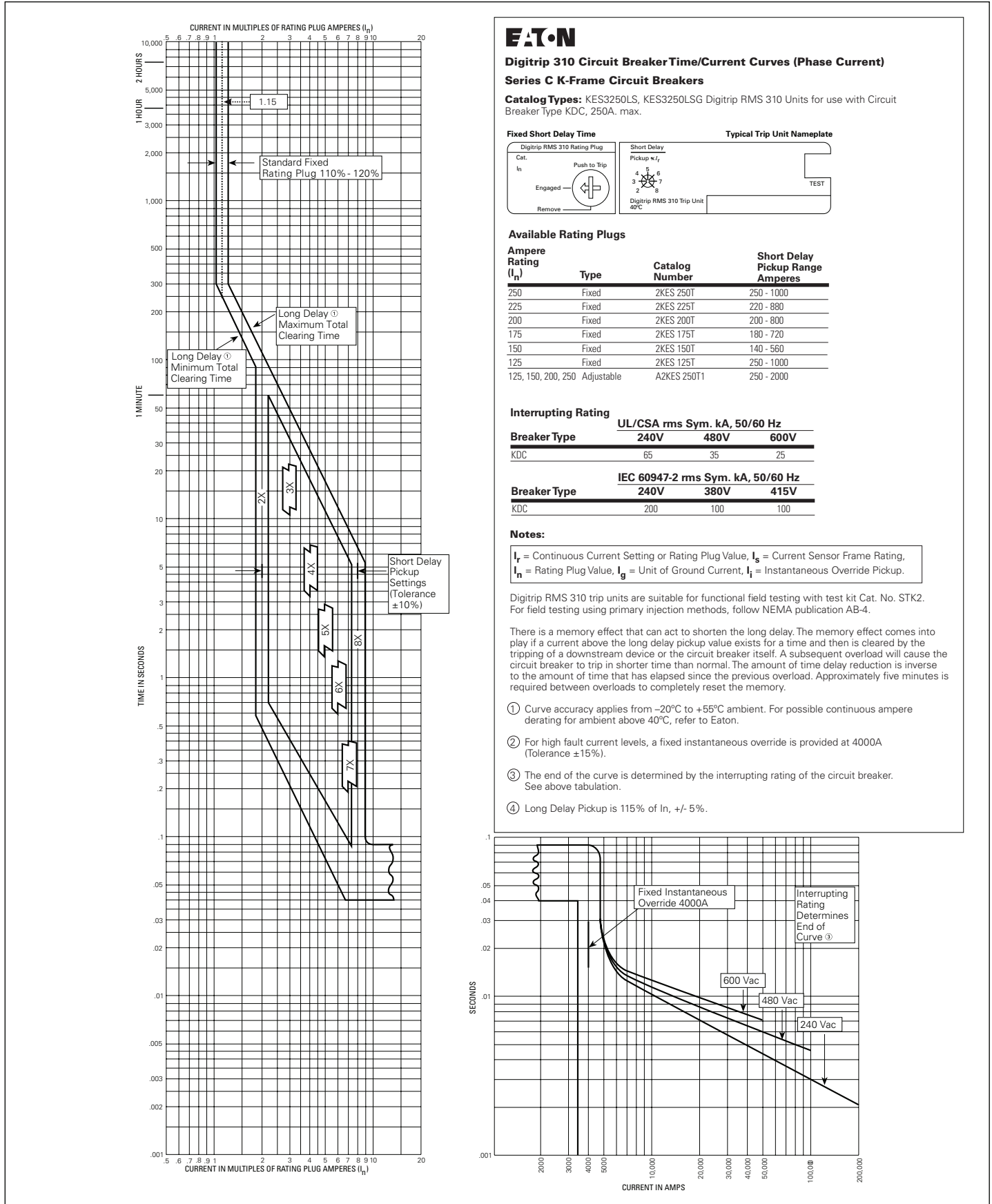
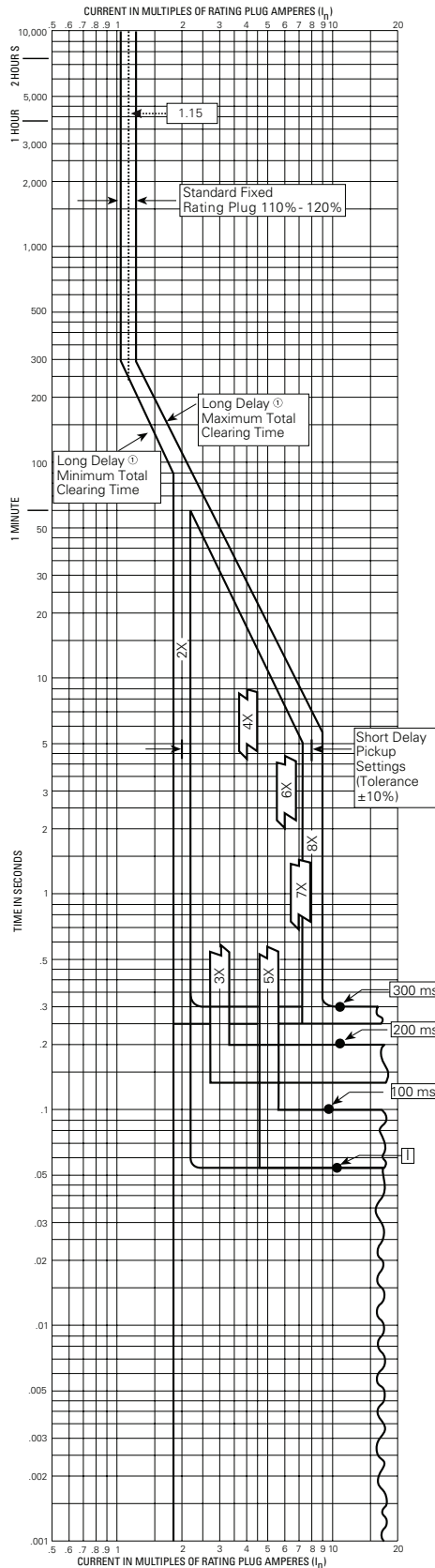

Figure 34. Series C Type KDC Circuit Breakers Equipped with Type KES Digitrip RMS 310 Trip Units, Types KES3250LS, KES3250LSG

- Legacy Product -



Digitrip 310 Circuit Breaker Time/Current Curves (Phase Current)
Series C K-Frame Circuit Breakers

Catalog Types: KES3250LSI, KES3250LSIG Digitrip RMS 310 Trip Units for use with Circuit Breaker Type KDC, 250A. max.

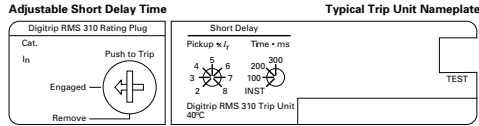

Available Rating Plugs

Ampere Rating (I_n)	Type	Catalog Number	Short Delay Pickup Range Amperes
250	Fixed	2KES 250T	500 - 2000
225	Fixed	2KES 225T	450 - 1800
200	Fixed	2KES 200T	400 - 1600
175	Fixed	2KES 175T	350 - 1400
150	Fixed	2KES 150T	300 - 1200
125	Fixed	2KES 125T	250 - 1000
125, 150, 200, 250	Adjustable	AZKES 250T1	250 - 1000

Interrupting Rating

Breaker Type	UL/CSA rms Sym. kA, 50/60 Hz		
	240V	480V	600V
KDC	200	100	50

Breaker Type	IEC 60947-2 rms Sym. kA, 50/60 Hz		
	240V	380V	415V
KDC	200	100	100

Notes:

I_r = Continuous Current Setting or Rating Plug Value, I_s = Current Sensor Frame Rating, I_n = Rating Plug Value, I_g = Unit of Ground Current, I_i = Instantaneous Override Pickup.

Digitrip RMS 310 trip units are suitable for functional field testing with test kit Cat. No. STK2. For field testing using primary injection methods, follow NEMA publication AB-4.

There is a memory effect that can act to shorten the long delay. The memory effect comes into play if a current above the long delay pickup value exists for a time and then is cleared by the tripping of a downstream device or the circuit breaker itself. A subsequent overload will cause the circuit breaker to trip in shorter time than normal. The amount of time delay reduction is inverse to the amount of time that has elapsed since the previous overload. Approximately five minutes is required between overloads to completely reset the memory.

- Curve accuracy applies from -20°C to $+55^{\circ}\text{C}$ ambient. For possible continuous ampere derating for ambient above 40°C , refer to Eaton.
- For high fault current levels, a fixed instantaneous override is provided at 4000A (Tolerance $\pm 15\%$).
- The end of the curve is determined by the interrupting rating of the circuit breaker. See above tabulation.
- Long Delay Pickup is 115% of I_n , $\pm 5\%$.

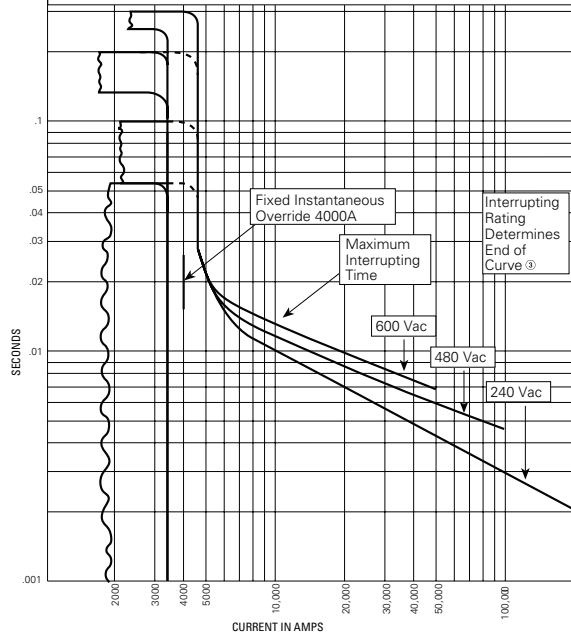

Figure 35. Series C Type KDC Circuit Breakers Equipped with Type KES Digitrip RMS 310 Trip Units, Types KES3250LSI, KES3250LSIG

- Legacy Product -

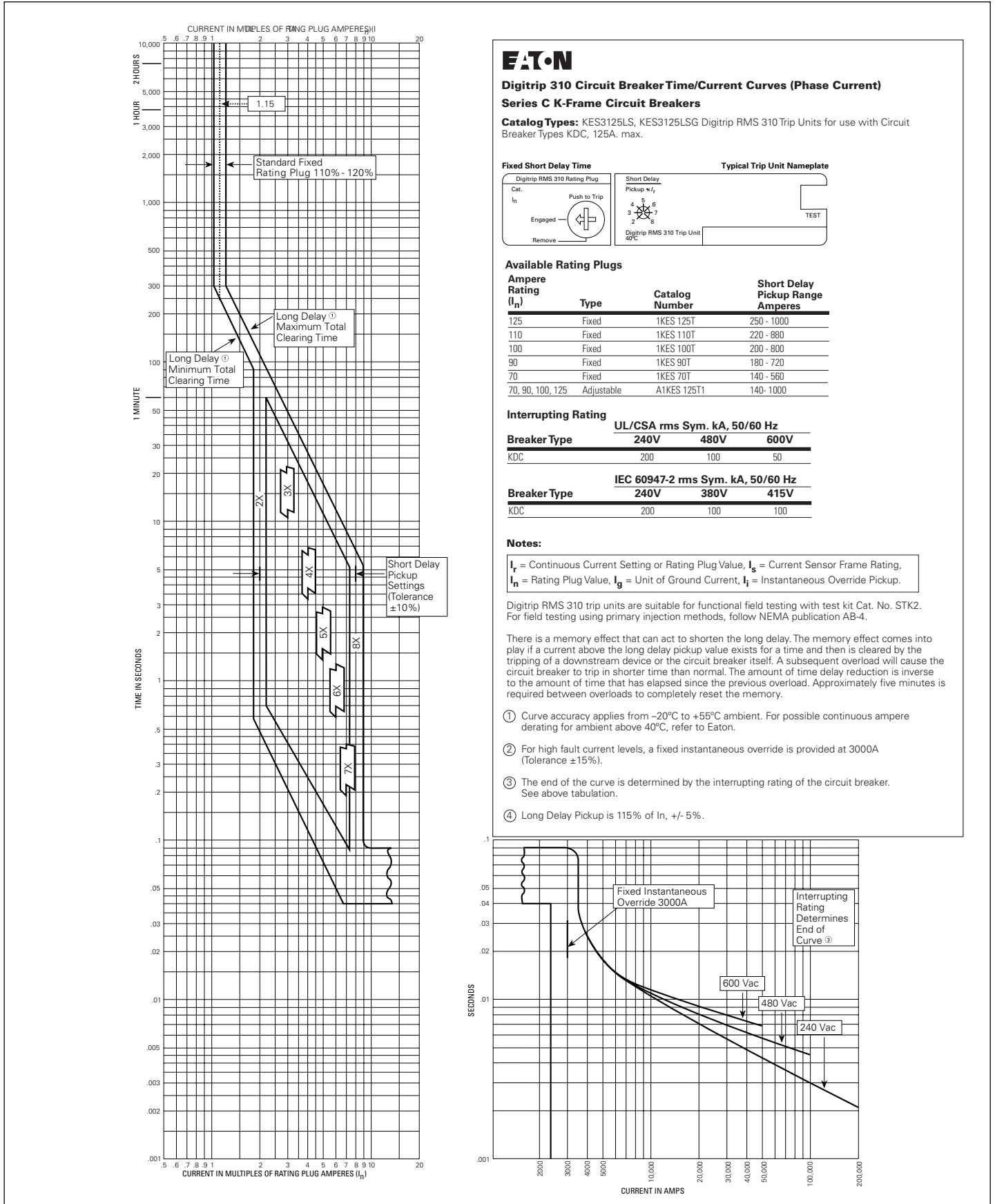

Figure 26. Series C Type KDC Circuit Breakers Equipped with Type KES Digitrip RMS 310 Trip Units, Types KES3125LS, KES3125LSG

- Legacy Product -



Digitrip 310 Circuit Breaker Time/Current Curves (Phase Current)

Series C K-Frame Circuit Breakers

Catalog Types: KES3125LSI, KES3125LSIG Digitrip RMS 310 Trip Units for use with Circuit Breaker Type KDC, 125A. max.

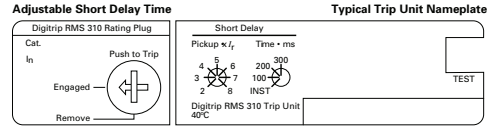

Available Rating Plugs

Ampere Rating (I_n)	Type	Catalog Number	Short Delay Pickup Range Amperes
125	Fixed	1KES 125T	250 - 1000
110	Fixed	1KES 110T	220 - 880
100	Fixed	1KES 100T	200 - 800
90	Fixed	1KES 90T	180 - 720
70	Fixed	1KES 70T	140 - 560
70, 90, 100, 125	Adjustable	A1KES 125T1	140 - 1000

Interrupting Rating

Breaker Type	UL/CSA rms Sym. kA, 50/60 Hz		
	240V	480V	600V
KDC	200	100	50

Breaker Type	IEC 60947-2 rms Sym. kA, 50/60 Hz		
	240V	380V	415V
KDC	200	100	100

Notes:

I_r = Continuous Current Setting or Rating Plug Value, I_s = Current Sensor Frame Rating, I_n = Rating Plug Value, I_g = Unit of Ground Current, I_i = Instantaneous Override Pickup.

Digitrip RMS 310 trip units are suitable for functional field testing with test kit Cat. No. STK2. For field testing using primary injection methods, follow NEMA publication AB-4.

There is a memory effect that can act to shorten the long delay. The memory effect comes into play if a current above the long delay pickup value exists for a time and then is cleared by the tripping of a downstream device or the circuit breaker itself. A subsequent overload will cause the circuit breaker to trip in shorter time than normal. The amount of time delay reduction is inverse to the amount of time that has elapsed since the previous overload. Approximately five minutes is required between overloads to completely reset the memory.

- Curve accuracy applies from -20°C to $+55^{\circ}\text{C}$ ambient. For possible continuous ampere derating for ambient above 40°C , refer to Eaton.
- For high fault current levels, a fixed instantaneous override is provided at 3000A (Tolerance $\pm 15\%$).
- The end of the curve is determined by the interrupting rating of the circuit breaker. See above tabulation.
- Long Delay Pickup is 115% of I_n , $\pm 5\%$.

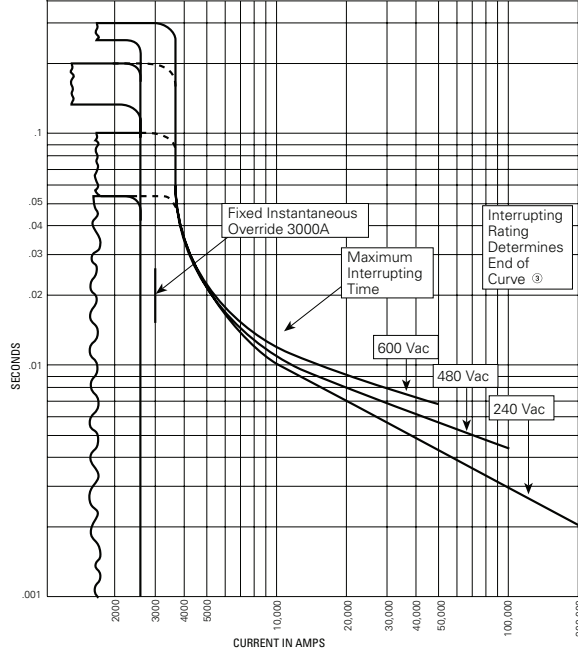
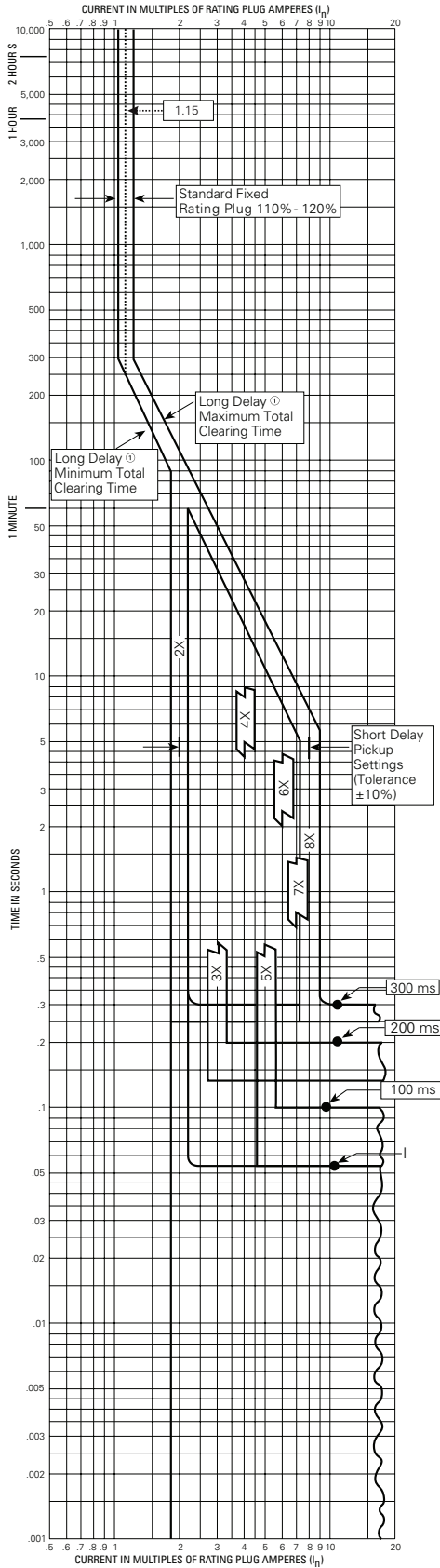
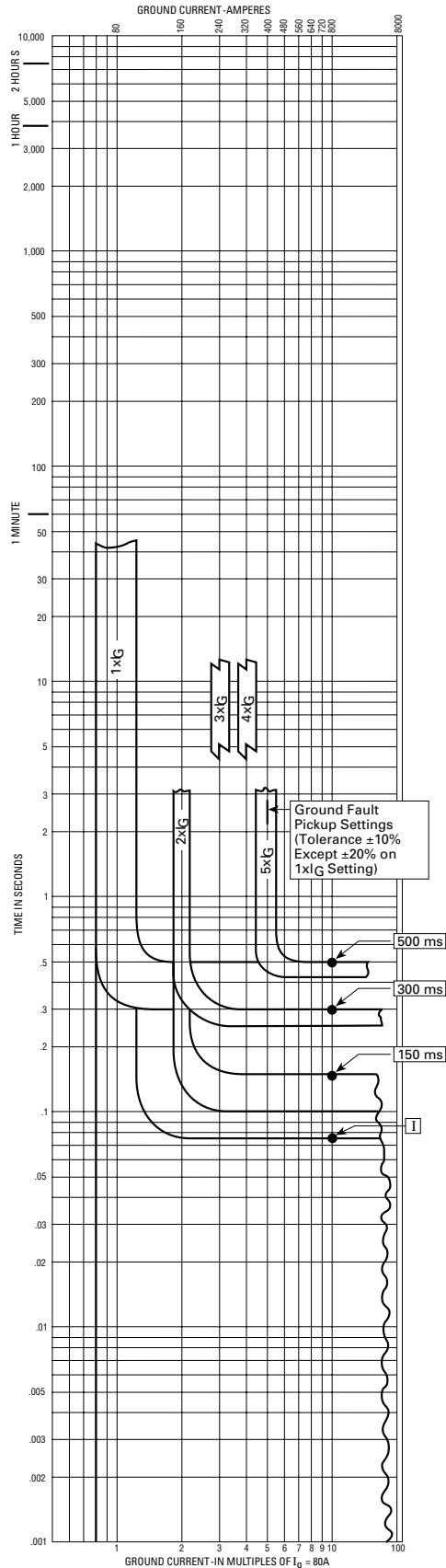

Figure 37. Series C Type KDC Circuit Breakers Equipped with Type KES Digitrip RMS 310 Trip Units, Types KES3125LSI, KES3125LSIG

- Legacy Product -



Digitrip 310 Circuit Breaker Time/Current Curves (Ground Current)
Series C K-Frame Circuit Breakers

Catalog Types: Type Digitrip RMS 310 Trip Unit for use with Circuit Breaker Types KDB, CKDB, HKDB, CHKDB, KD, HKD, KDC, CKD, and CHKD

For use with Trip Unit Catalog Numbers
KES3400LSG
KES3400LSIG

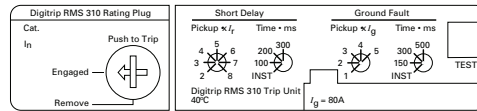
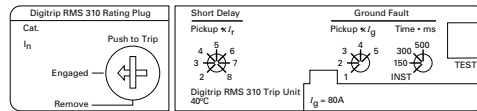

Notes:

I_r = Continuous Current Setting or Rating Plug Value, I_g = Current Sensor Frame Rating,
 I_n = Rating Plug Value, I_g = Unit of Ground Current, I_i = Instantaneous Override Pickup.

Curve accuracy applies from $-20^\circ C$ to $+55^\circ C$ ambient. For possible continuous ampere derating for ambient above $40^\circ C$, refer to Eaton.

Digitrip RMS 310 trip units are suitable for functional field testing with test kit Cat. No. STK2. For field testing using primary injection methods, follow NEMA publication AB-4.

Figure 38. Series C Type KDC Circuit Breakers Equipped with Type KES Digitrip RMS 310 Trip Units, Ground Fault Protection (KES3400LSG, KES3400LSIG)

- Legacy Product -

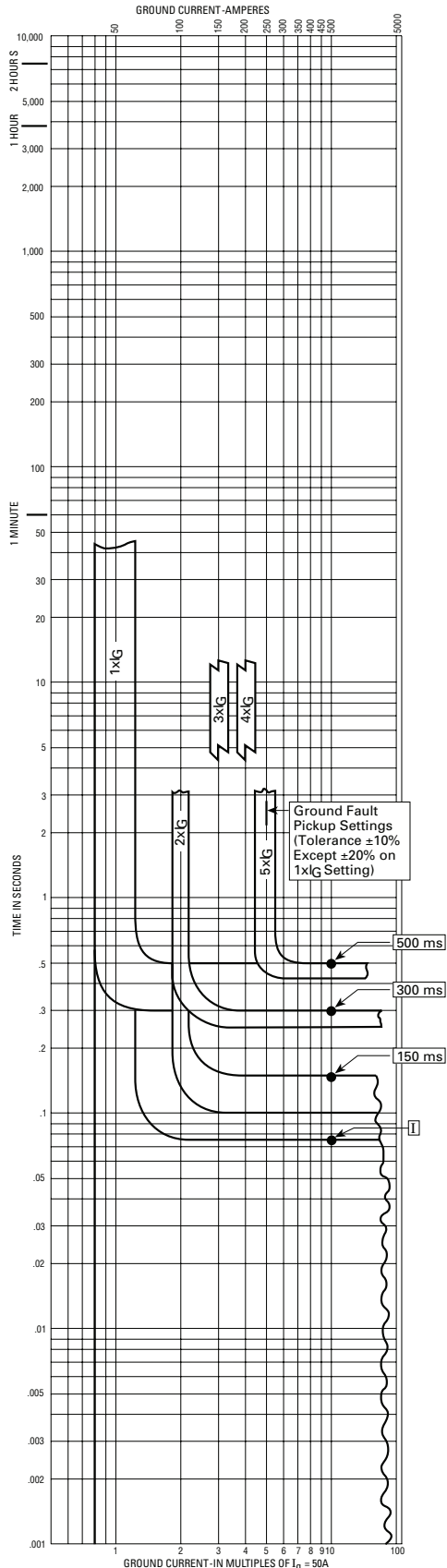

Digitrip 310 Circuit Breaker Time/Current Curves (Ground Current)
Series C K-Frame Circuit Breakers

Type Digitrip RMS 310 Trip Unit for use with Circuit Breaker Types KDB, CKDB, HKDB, CHKDB, KD, HKD, KDC, CKD, and CHKD

For use with Trip Unit Catalog Numbers
KES3250LSG
KES3250LSIG

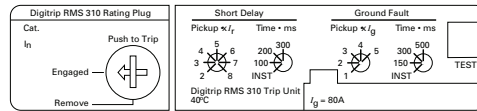
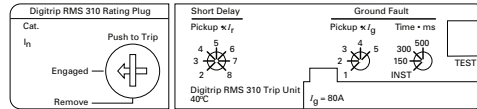

Notes:

I_r = Continuous Current Setting or Rating Plug Value, I_g = Current Sensor Frame Rating,
 I_n = Rating Plug Value, I_g = Unit of Ground Current, I_1 = Instantaneous Override Pickup.

Curve accuracy applies from -20°C to +55°C ambient. For possible continuous ampere derating for ambient above 40°C, refer to Eaton.

Digitrip RMS 310 trip units are suitable for functional field testing with test kit Cat. No. STK2. For field testing using primary injection methods, follow NEMA publication AB-4.

Figure 39. Series C Type KDC Circuit Breakers Equipped with Type KES Digitrip RMS 310 Trip Units, Ground Fault Protection (KES3250LSG, KES3250LSIG)

- Legacy Product -

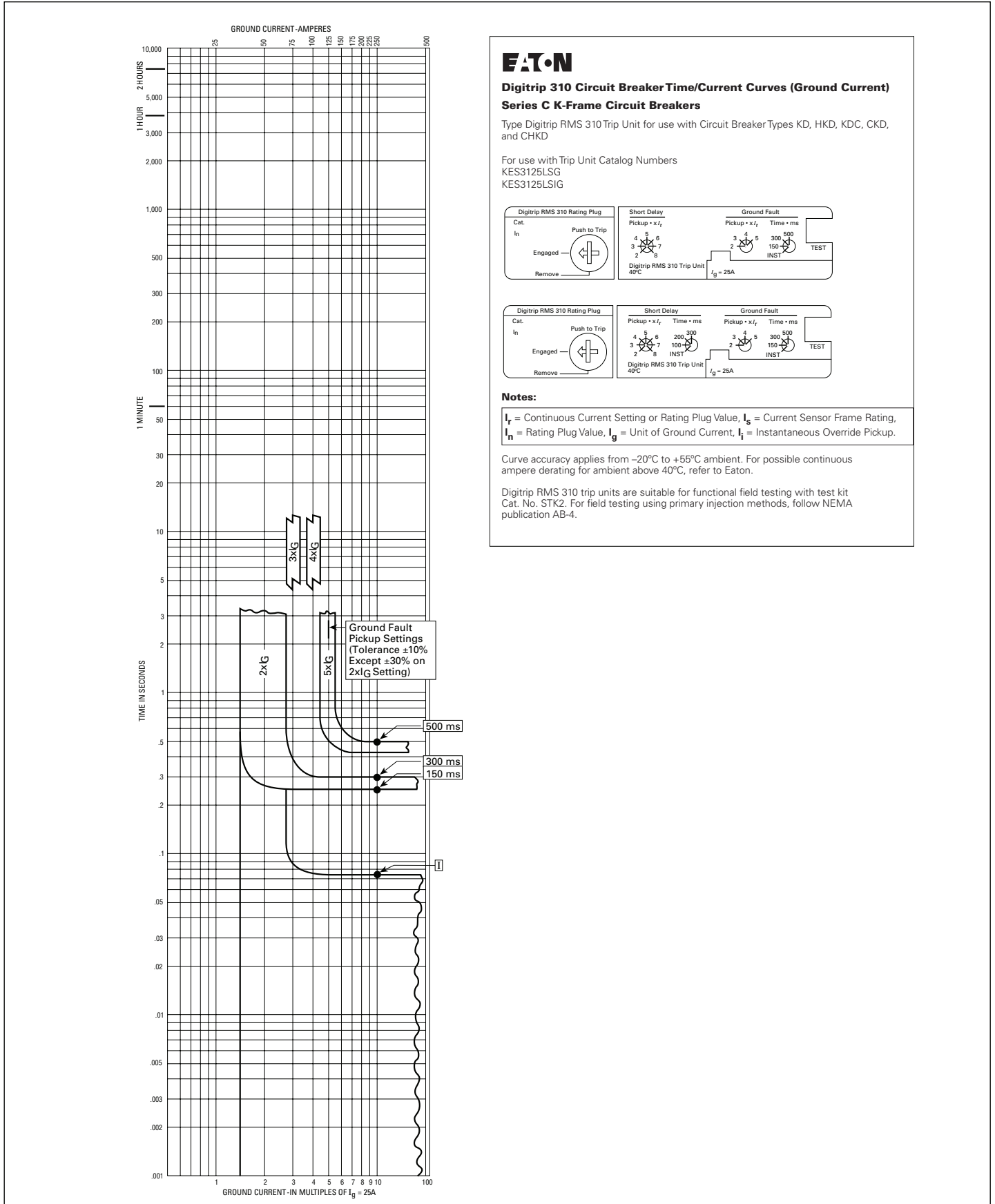
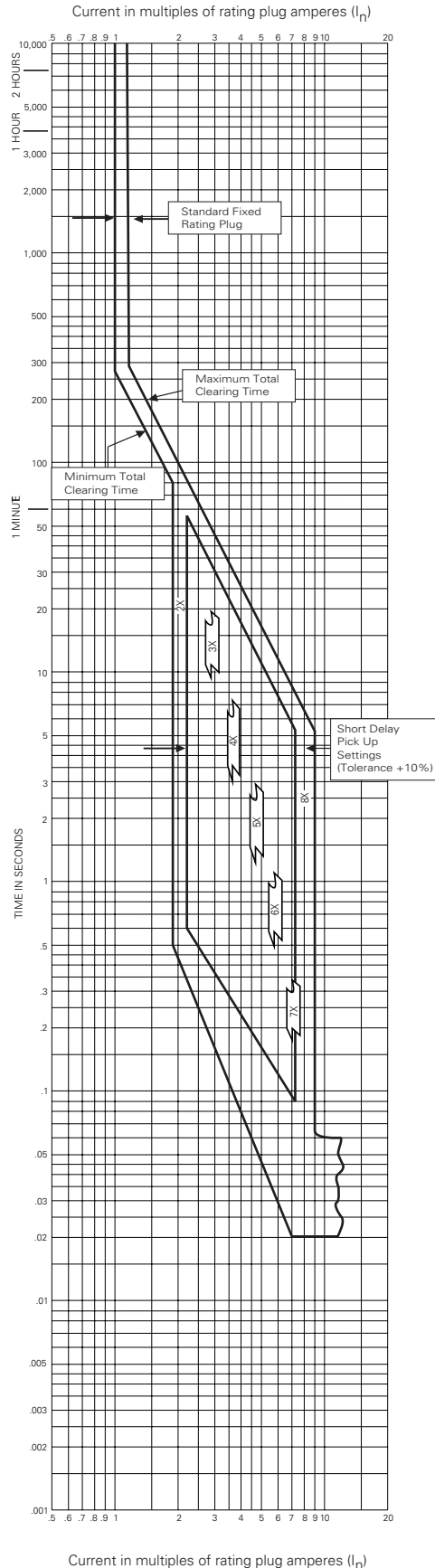
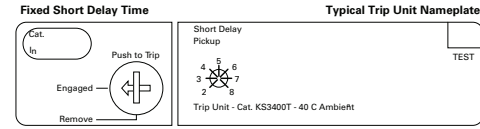

Figure 40. Series C Type KDC Circuit Breakers Equipped with Type KES Digitrip RMS 310 Trip Units, Ground Fault Protection (KES3125LSG, KES3125LSIG)



Circuit Breaker Time/Current Curves (Phase Current)
Series C - Type KS Circuit Breakers

Catalog Types: KS3400T, KS3400TG, KS Trip Units for use with Circuit Breaker Type KDC, 400A. max



Available Rating Plugs

Ampere Rating (I _n)	Type	Catalog Number	Short Delay Pickup Range Amperes
400	Fixed	4KS 400T	800 - 3200
350	Fixed	4KS 350T	700 - 2800
300	Fixed	4KS 300T	600 - 2400
250	Fixed	4KS 250T	500 - 2000
225	Fixed	4KS 225T	450 - 2000
200	Fixed	4KS 200T	400 - 1600
200, 250, 300, 400	Adjustable	A4KS 400T1	400 - 3200
200, 300, 350, 400	Adjustable	A4KS 400T3	500 - 3200

Interrupting Rating

Breaker Type	UL/CSA rms Sym. kA, 50/60 Hz		
	240V	480V	600V
KDC	200	100	50

Breaker Type	IEC 60947-2 rms Sym. kA, 50/60 Hz		
	240V	380V	415V
KDC	200	100	100

- Curve accuracy applies from -20°C to +55°C ambient. For possible continuous ampere derating for ambient above 40°C, refer to Eaton.
- For high fault current levels, a fixed instantaneous override is provided at 4000A (Tolerance ±15%).
- The end of the curve is determined by the interrupting rating of the circuit breaker. See above tabulation.
- KS trip units are suitable for functional field testing with test kit Cat. No. STK2. For field testing using primary injection methods, follow NEMA publication AB-4.

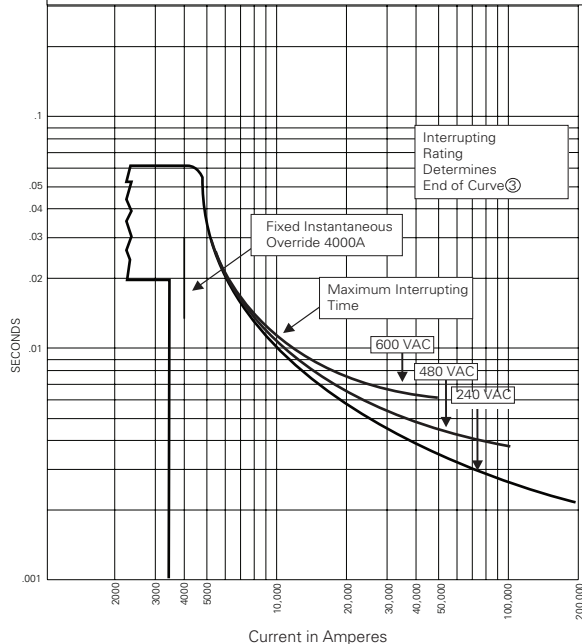

Figure 41. KS Electronic Trip Unit Type KDC - Curve Number SC-4156-87A,1987

Eaton
1000 Eaton Boulevard
Cleveland, OH 44122
United States
Eaton.com

© 2014 Eaton
All Rights Reserved
Printed in USA
Publication No. TD012034EN / KDC
April 2014



Eaton is a registered trademark.

All other trademarks are property
of their respective owners.