



Photovoltaic 2017

for commercial application

EATON

Powering Business Worldwide



Aerospace



Truck



Powering business worldwide

Discover Eaton – a leader in the power management field

Since 1911, when our company began trading as a small truck parts supplier, Eaton® Corporation has come a long way. Today, as a diversified power management company, Eaton has sales of \$13.7 billion USD (FY 2010), employs 70,000 people and has customers in more than 150 countries. Everyday, we help companies across the world to manage power, and do more, while consuming less energy.

Eaton's innovative products, solutions and technologies are designed to help customers manage power and conserve resources while working more productively, safely and sustainably. Our integrated and diversified business strategy ensures that we remain at the forefront of our industry, decade after decade.

Aerospace

A leading global supplier to commercial and military aviation and aerospace industries. An extensive technology portfolio includes hydraulic systems, fuel systems, motion control systems, propulsion sub-systems, cockpit controls and displays and fluid health monitoring systems. Our products improve fuel economy, aircraft performance, reliability and safety.

Truck

A leader in the design, manufacturing and marketing of complete line of drivetrain systems and components for medium- and heavy-duty commercial vehicles. Under the "Roadranger" brand, Eaton also markets lubricants, safety products and service tools. Eaton's hybrid power systems have earned the company recognition as a global leader in alternative power for commercial vehicles.

Electrical

A global leader in electrical control, power distribution, uninterruptible power supply and industrial automation products and services. Our products provide customer-driven PowerChain Management® solutions to serve the power system needs of the industrial, institutional, government, utility, commercial, residential, IT, mission critical and OEM markets worldwide.



Powering Business Worldwide



Electrical



Automotive



Hydraulics

Powering business more sustainably

Sustainability – smaller footprint in the world

The principle of sustainability means meeting the current needs of our own society without compromising the needs or options of future generations. It is a principle, which forms the very core of our design and production philosophy and guides all our activities across the world. Our commitment to reducing our own ecological footprint covers a wide range of green technologies, products and services that help our customers utilise electrical power more efficiently, while improving environmental performance.

2012
WORLD'S MOST
ETHICAL
COMPANIES
WWW.ETHISPHERE.COM

Eaton is known around the world for its uncompromising approach to ethical business practices and every year since 2007 they have been ranked by the Ethisphere Institute as one of the “world’s most ethical companies”.



An Eaton Green Solution

Learn more about Eaton Green Solutions at www.eaton.com/greensolutions

When you see this symbol, you know the solution represents an Eaton benchmark for environmental performance.

Automotive

A supplier of critical components that reduce emissions and fuel consumption and improve stability and performance of cars, light trucks and commercial vehicles. Principal products include engine valves and valve train components, transmission and engine controls, supercharger, locking and limited slip differentials, cylinder heads, fluid conveyance components, body mouldings and spoilers.

Hydraulics

A worldwide leader in reliable, high-efficiency hydraulic systems and components for use in mobile and industrial applications. Markets include agriculture, construction, mining, forestry, utility, material handling, earth moving, truck and bus, machine tools, moulding, primary metals, automotive, power generation, port machinery and entertainment.

An important step towards a reliable energy supply in the future



The sun provides life on our planet. As a source of energy, it holds unimaginable potential for supplying energy in the future.

In view of the world's climate and energy goals, as well as the catastrophic events surrounding nuclear power plants, solar power is increasingly gaining importance. The industry is now experiencing increased demand for industrial-sized plants, such as solar roof systems atop commercial buildings, following enormous interest in the residential construction sector.

Did you know ...

- ... that such a system with an output of 7.4 MW would be capable of generating approx. 7.3 million kWh of energy every year, which would correspond to the annual requirements of approx. 1,800 homes?
- ... that the largest photovoltaic installation worldwide generates a total output of 150MWp? It was launched in Brandenburg (Germany) in September 2011.
- ... that in Germany, since 2011 and for the first time ever, there has been more solar capacity connected to the grid than energy provided by nuclear power plants? Germany continues to be the largest photovoltaic market, at the end of 2011, it had a total capacity of approx. 20 GW installed. Systems generating a total

output of 7500 MW have been set up in 2011 alone.

- ... that renewable energies would not make electricity more expensive, but rather have a restraining effect on prices?
- ... that up until the end of 2011, the total photovoltaic capacity installed around the globe was 67 GW and that 27 GW are being added every year?

In the meantime, the renewable energy industry has become an astounding economic factor, revitalising the employment market and creating numerous „green jobs“.

The choice of the right components for a PV system is of fundamental importance. The system will be in operation for many years and all parts of the system must satisfy the highest standards. The appropriate quality and longevity, as well as warranties and Service support are necessary in order to guarantee long-term success.

Here you can see the industrial-size systems that Eaton offers.





Leading the way with safety ...

Eaton ensures the reliable availability of renewable energies – safe for people and good for the environment.

From solar module to power grid

Solar power is becoming increasingly more important and safety plays a decisive role. From the outset, it pays to invest in the right technology. Eaton delivers all products needed to safely transport energy from solar panels to the power grid. Reliable protection, separation and control technology provide for the safe operation of photovoltaic systems, using integrated or external separation equipment for automated and manual operation and for both direct and alternate currents (DC/AC).

Safety from the start

Proper planning and design are crucial to the safe and reliable operation of a photovoltaic plant, and ensure trouble-free operation of all switching, contacting, protection, separation, insulation and monitoring functions.

Through intensive cooperation with system integrators, manufacturers and switch gear plant builders, Eaton offers full peace of mind, right from the start.

As one of the leading global energy management companies, Eaton guarantees know-how, proximity and the dynamics you need to successfully complete your project. Moreover, as a global

player and partner, Eaton stands for high product availability, outstanding quality and exceptional service for individual solutions.

It is this high level of innovation combined with environmentally proven technology, that has characterized the quality and daily operational use of Eaton products in the field for many years.

Renewable energy is a part of the markets of the future.

Having Eaton as an experienced, reliable partner is a good thing:

- High-quality circuit breaker series, especially for photovoltaic use
- Reliable and fail-safe
- Eaton has been a global player and reliable partner for more than 100 years, with decades-long experience in energy distribution

AC components

Quality and safety on the AC current level: Eaton AC components.

Eaton also supplies everything on the AC level that you require for the safety and efficiency of your photovoltaic installation. Eaton components guarantee the best possible installation safety and assure reliable operation and optimum power feed.



Protective switchgear such as MCBs, RCBs and combined RCBOs

A new type of protective switchgear equipped with integrated and patent-registered digital technology adds even more safety and reliability to photovoltaic systems of the future. Digital RCBOs featuring a B+ characteristic are able to identify fault currents in both the alternate and direct current range, they warn operators at a very early stage before any damage can occur in the system, and they meet all the requirements for enhanced fire protection pursuant to the relevant STANDARD. MCBs and combined RCBOs complete our offering for safe energy distribution.



Grid & systems protection for up to 100 kVA, ready-to-connect, with an extremely low level of own consumption

For system sizes ranging from 30 to 100kVA, Eaton has developed a compact, ready-to-connect combination. It comes in a plastic enclosure, features an IP65 degree of protection and meets the requirements of the VDE-AR-N 4105 standard. The combination includes two contactors switched in series, actuated by a grid & systems protective relay that comes prewired and mounted inside an enclosure. The recently developed grid & system protection is installed between the power inverter and the grid connection. It is easy to install and fix in wall-mounting technology. The DILMP contactor type used by Eaton is particularly efficient thanks to an electronic solenoid drive requiring a holding power of only 2.1W. Eaton's combined grid & systems protection is available in four rating classes.



Contactors DIL

The contactors DIL H safely switch the power inverters onto the grid. The innovative construction design using vacuum tubes reduces the holding power by up to 96 %. Accordingly, not only is the heat development in the control panel reduced, but also the day-to-day operating costs. Seven sizes cover the power range up to 2600 A. Eaton also offers 4-pole contactors up to 800 A.



AC components



Circuit-breakers NZM and IZM

The circuit-breaker series NZM offers optimum installation protection up to 1600 A with four sizes. The air circuit-breaker IZM, also with four sizes, covers the power range up to 6300 A. Both series are characterised by their high switching capacities and comprehensive range of accessories and provide a solution for every application. Eight sizes allow you to cost-effectively engineer the required dimensions and ratings of the switch.



Control and monitoring

Eaton panels are operating and monitoring devices that also can be used as control devices. Modern touch panels cater for clear, flexible menu-guidance in every desired language and allow worldwide application with just one hardware and software solution. The optimum solution is available for every application with touch panels from 3.5" to 19".



Medium-voltage systems XIRIA

XIRIA ring main units protect applications up to 24 kV. They operate with a combination comprised of circuit-breakers and electronic relays and feature high level of operational safety and a compact design. They are available in three or four panel versions.



DC components

Quality and safety for the entire DC current requirements: Eaton DC components.

Power grid coupled photovoltaic systems feed the generated power directly into the electrical grid without complex and costly intermediate storage. An installation of this kind mainly consists on the DC end of solar modules, cables and different switchgear for operation, maintenance and protection in the event of a fault. Eaton provides you with a complete product range for protection, switching and isolation to safely and efficiently transport the solar energy from the individual solar modules to the power inverter.



PV fireman's switches for up to 6 Strings

PV fireman's switches are DC switch-disconnectors that isolate the lines between solar modules and inverters. They allow firefighters to operate without risk of electrocution. In addition to the SOL30-Safety for small installations Eaton offers prefabricated fireman's switches housing 2, 3, 4 or 6 switch-disconnectors in a common enclosure. In contrast to generator terminal boxes the individual strings are not connected in parallel but can be fed separately to the inverter. This allows the use of several MPP trackers and helps optimize the inverter's performance.



String circuit-breakers PKZ-SOL

The fuseless alternative for protection against short circuit currents with the string circuit-breaker PKZ-SOL. With their variable trip range, they can be optimally adjusted to the actual short-circuit current of a string. A thermal release reacts at 1.05 ... 1.3 fold current, and the magnetic release at 6-fold current. Non-enclosed string circuit-breakers are intended for installation in customized generator connection enclosures.



DC switch disconnectors

Switch-disconnectors N...DC in the special version for up to 1500 V DC can be used on 1 or 2-poles. They comply with the isolation properties even for earthed IT networks. Accessories, such as Bridge kits, connection terminals and door coupling rotary handles, enable individual installation in the most varied of distribution systems. Auxiliary switches, voltage releases and remote operators facilitate signalling and automation.



DC components



DC overvoltage protection

The surge arrester SPPT2PA has been developed especially for photovoltaic applications and protects the installations against transient overvoltages that can be induced by indirect lightning strikes. Eaton provides versions for both earthed and unearthed installations, where spark gaps are used to ensure galvanic isolation. Naturally, the units are available as prewired ready-to-use modules – just install and they are ready to go.

Eaton also offers a wide product range in AC surge protective devices.

CI insulated enclosures

The weather-proof CI enclosures with the enhanced degree of protection IP 65 are ideal for outdoor installation. Thus, you can safely and cost-effectively protect and install your switchgear. The modular design simplifies the adaptation to different application areas, such as generator connection enclosures for direct protection of several strings in a field.

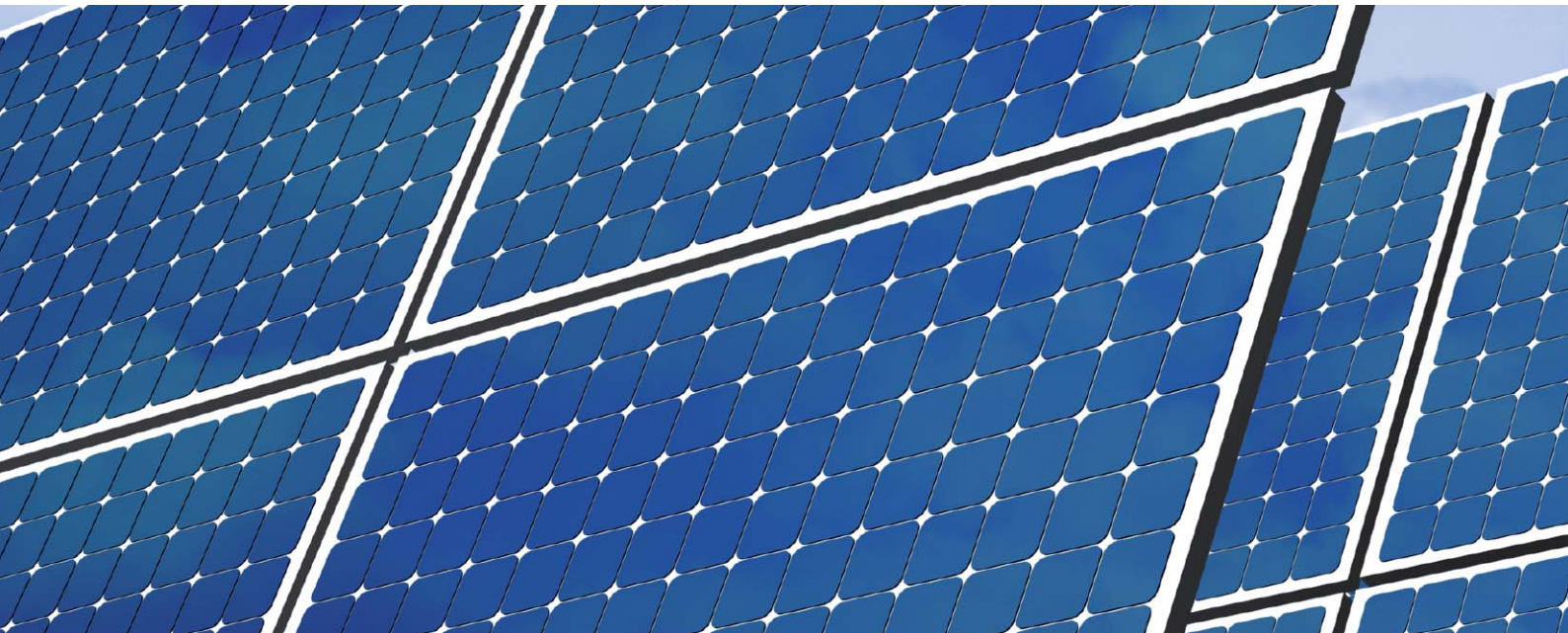



Photovoltaic plants convert the electromagnetic spectrum of the sun into electricity. The core element consists of solar panels (combined in modules) which separate photon bombardment into positive and negative charges. The term photovoltaic combines the Greek word “of light” (photos) and the name of the Italian physicist Alessandro Volta.

Sputnik Engineering AG

Sputnik Engineering specialises in the development, operation and maintenance of inverters for grid connected photovoltaic plants.

With SolarMax, the company offers a broad range of string inverters for private homes and central inverters for solar power plants. From the very start, it was the aim of the founders of Sputnik to try and realize their vision to generate electricity from sunlight. And it is thanks to this commitment to research, and the success that followed, that allowed Sputnik to consolidate and maintain its position within the industry today.

“Inverters from Sputnik Engineering stand for Swiss quality, and it is for this reason that we have chosen suppliers which meet our high standards,” explains Managing Director Christoph von Bergen.

“Any failure at a photovoltaic plant can be costly. We avoid this by using proven components designed specifically for this industry. Eaton not only offers these high-quality components – they can guarantee excellent support and advice on site.”



Schott Solar AG

With its headquarters in Mainz (Germany), Schott Solar has more than 50 years of experience in the field of solar technology and employs more than 1400 people worldwide.

The company develops, manufactures and markets highly efficient solar receivers, alongside innovative and high-quality photovoltaic products.

“In every respect, circuit-breakers from Eaton meet our quality and safety standards,” explains Ralf Bolland, Head of Technical Operations for Schott Spain.

“An international presence is also very important for us. In service situations we need immediate

support, both for the fast supply of spare parts and in specific technical challenges. And it is here that we

rely on the extensive know-how of Eaton.”



Content



PV-Fireman's switch Page 12



DC-Disconnectors Page 14



Surge Protection Page 20



Ci insulated enclosures Page 29



DC-Disconnectors to 1500 V
Page 35



Contactors DILM
Page 46



Grid & systems protection
Page 47

Photovoltaik - Fireman's switch

PV-SOL30X...-SAFETY fireman's switch

- Rated operating voltage 1000 VDC
- Rated operational current of each switch-disconnector 30 A
- DC-21A utilization category
- Switch-disconnectors tested to IEC/EN 60947-3
- Prewired ready for connection
- IP65 protection type
- Admissible ambient temperature range -25°C up to +60°C
- Scope of application: DC isolation in photovoltaic systems between PV generator and inverter for disconnecting power
- Remote tripping with integrated undervoltage release 230V, 50Hz
- Undervoltage release responds with a delay of 0.6 seconds to bridge short-term mains voltage fluctuations
- Signalling of switch state via auxiliary contact 1 N/O and 1 N/C
- Internal resistance of each switch-disconnector 7m
- Pressure equalization element

	Number Switch-disconnectors	Rated-operating voltage U_e V	Rated operational current I_e of each switch-disconnector A	Number and type of Terminal type		Terminal capacity Flexible with ferrule mm ²	Weight kg
				INPUT	OUTPUT		
SOL30-safety_hpl 	1	1000	30	2xMC4 (+) 2xMC4 (-)	1xMC4 (+) 1xMC4 (-)	max.6	0,47
	1	1000	30	2xM12 (+) 2xM12 (-) *1)	1xM12 (+) 1xM12 (-)	1x(max.6),2x(max.6)	0,47
SOL30x2_safety_mv_u *2) 	2	1000	30	2xMC4 (+) 2xMC4 (-)	2xMC4 (+) 2xMC4 (-)	max.6	5,1
	2	1000	30	2xMC12 (+) 2xMC12 (-)	2xMC12 (+) 2xMC12 (-)	max.6	5,1
SOL30X3-MV-U_HPL *2) 	3	1000	30	3xMC4 (+) 3xMC4 (-)	3xMC4 (+) 3xMC4 (-)	max.6	5,5
	3	1000	30	3xMC12 (+) 3xMC12 (-)	3xMC12 (+) 3xMC12 (-)	max.6	5,5
SOL30X4-SAFETY-MV-U *2) 	4	1000	30	4xMC4 (+) 4xMC4 (-)	4xMC4 (+) 4xMC4 (-)	max.6	6,8
	4	1000	30	4xMC12 (+) 4xMC12 (-)	4xMC12 (+) 4xMC12 (-)	max.6	6,8
SOL30X4-SAFETY-MC4-U *2) 	6	1000	30	6xMC4 (+) 6xMC4 (-)	6xMC4 (+) 6xMC4 (-)	max.6	9,5
	6	1000	30	6xMC12 (+) 6xMC12 (-)	6xMC12 (+) 6xMC12 (-)	max.6	9,5

*1) Two strings can be connected in parallel

*2) All fireman's switches are fingerproof through IP4X cover

Photovoltaik - Fireman's switch

Dimensions	Type designation Article No.
mm	
	SOL30-SAFETY/2MC4-U (230V50HZ) 144122
	SOL30-SAFETY/2MV-U (230V50HZ) 144123
	SOL30X2-SAFETY-MC4-U (230V50HZ) 168098
	SOL30X2-SAFETY-MV-U (230V50HZ) 168099
	SOL30X3-SAFETY-MC4-U (230V50HZ) 168100
	SOL30X3-SAFETY-MV-U (230V50HZ) 168101
	SOL30X4-SAFETY-MC4-U (230V50HZ) 168102
	SOL30X4-SAFETY-MV-U (230V50HZ) 168103
	SOL30X6-SAFETY-MC4-U (230V50HZ) 168104
	SOL30X6-SAFETY-MV-U (230V50HZ) 168105

PV off switch

- IP 65 protection type
- Tamper-proof according to ISO 13850/EN 418
- Pull to release or rotate
- Color enclosure top: red

Description

Type designation
Article No.

0389_TasterHPL1



Complete with guard-ring, 1 N/O, 1 N/C

M22-SOL-PVT45PMPI11Q
150644

Complete with guard-ring, 2 N/C

M22-SOL-PVT45PMPI02Q
150645

M22-SOL-PVPL11-230Q_HPL



Complete, 1 N/O, 1 N/C sealable

M22-SOL-PVLPL11-230Q
152627

Wiring diagram of fireman's switch SOL30X...SAFETY

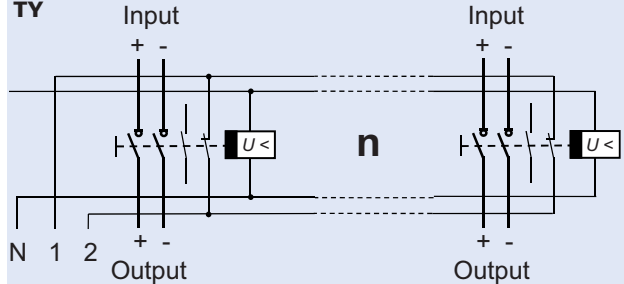

- n: Number of PV fire-fighter switches in a combination
 L - N: Undervoltage release (D1, D2) to the grid
 1 - 2: Warning message from Normally closed 1.61 - 1.62 when load disconnecter switch is open

* IP4X cover of fireman's switches

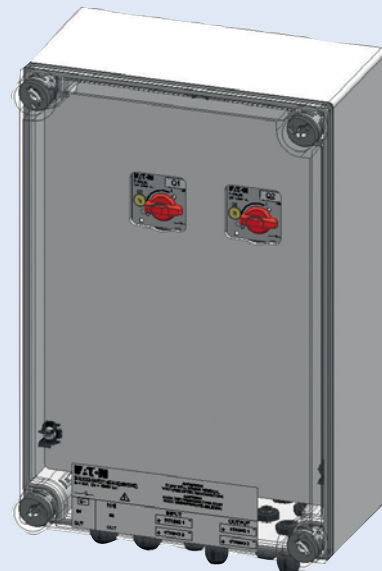

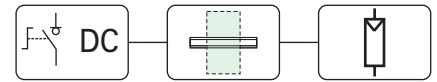

DC switch-disconnector

DC switch-disconnector P-SOL 2-poles

- Rated operational voltage 1000 VDC
- Utilization category DC-21A

wa_sg05409, wa_sg04709



Rated op. current I _e	Type designation	Article No.	Units per package
20A	P-SOL20	120934	1
30A	P-SOL30	120935	1
63A	P-SOL60	120936	1

Connection diagrams:

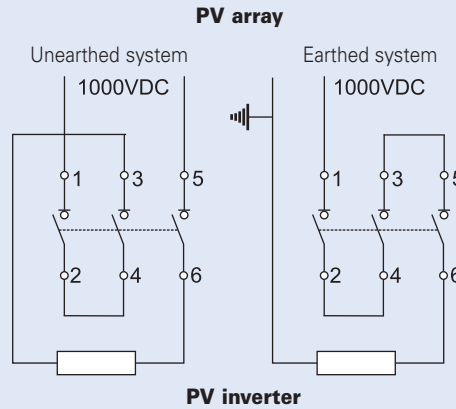

DC switch-disconnector

DC switch-disconnector SOL 2-poles as pre-wired unit with protection class II, degree of protection IP65

- Rated operational voltage 1000 VDC
- Utilization category DC-21A
- Rated operational current I_e of 20, 30 or 63 A
- Several versions – plugs MC4 or cable glands available
- Versions for 2, 3 and 4 strings (INPUT) available

wa_sg00110



I _e	INPUT	OUTPUT	Type designation	Article No.	Units per package
MC4 version					
20A	2xMC4	1xMC4	SOL20/2MC4	120915	1
20A	4xMC4	1xMC4	SOL20/4MC4	120916	1
30A	2xMC4	1xMC4	SOL30/2MC4	120922	1
30A	4xMC4	1xMC4	SOL30/4MC4	120923	1

Version with metric cable glands

20A	2xM12	1xM16	SOL20/2MV	120919	1
30A	2xM12	1xM16	SOL30/2MV	120926	1

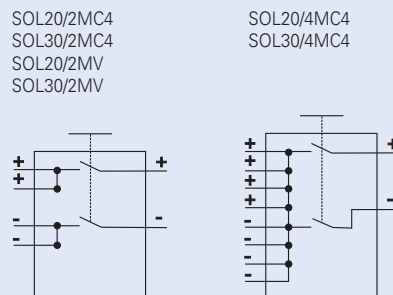

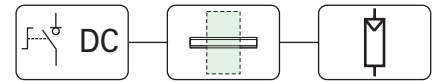

DC string circuit-breaker

DC string circuit-breaker PKZ-SOL 2-poles

- Rated operational voltage 900 VDC
- Rated current I_n 4, 7, 12, 20, and 30 A
- For permissible string short-circuit currents I_{sc} of 5 up to 22 A

wa_sg05409



I_n	I_{sc}	Type designation	Article No.	Units per package
4A	1,6-3A	PKZ-SOL4	144069	1
7A	2,6-5A	PKZ-SOL7	144120	1
12A	5-9A	PKZ-SOL12	120937	1
20A	9-15A	PKZ-SOL20	120938	1
30A	15-22A	PKZ-SOL30	120939	1

Connection diagrams:

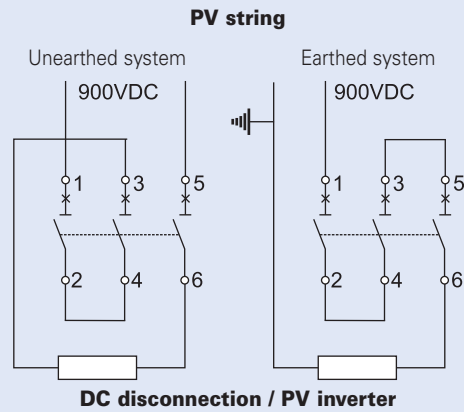

Photovoltaic - DC String Protection

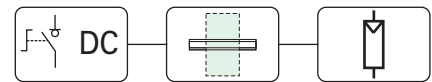

DC Switch-disconnector P-SOL

- Field of application:
DC-Disconnection in photovoltaic systems between PV Array and Inverter to switch off the energy
- No polarity
- Any mounting position
- Spring work contacts
- Tested according to IEC/EN 60947-3, UL508
- Certificate TÜV-Rheinland
- Application acc. to IEC 60364-7-712 and IEC 62548

Connection diagram

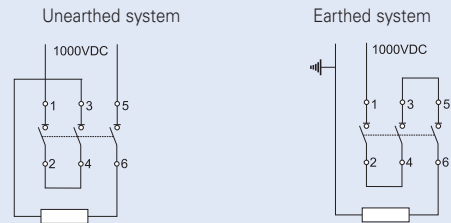

Technical Data

	P-SOL20	P-SOL30	P-SOL60
Electrical			
Number of poles	2	2	2
Rated operational voltage U_e	1000 VDC	1000 VDC	1000 VDC
Rated operational current I_e	20 A	30 A	63 A
Rated short-circuit making capacity I_{cm}	500 A	500 A	1500 A
Rated short-time withstand current 1sec. I_{cw}	700 A	700 A	1500 A
Utilization category	DC-21 A	DC-21 A	DC-21 A
Overvoltage category	III	III	III
Rated impulse withstand voltage U_{imp}	8 kV	8 kV	8 kV
Operating cycles electrical at U_e and I_e	1500	1500	1500
Internal resistance	6mΩ	5mΩ	3mΩ

Mechanical			
Width	58	58	55
Height	93	93	140
Depth	76	76	160
Weight	265 g	265 g	920 g
Mounting quick fastening on DIN rail acc. to IEC/EN 60517	35 mm	35 mm	35 mm
Screw fastening			2xM4x18
Degree of protection	IP20	IP20	IP20
Terminal capacity Flexible with end sleeve	2x (1-6)	2x (1-6)	2x (1-35)
AWG	18-10	18-10	14-2
Tightening torque of terminal screws	1,7 Nm	1,7 Nm	3 Nm
Ambient temperature range	-25°C to +60°C	-25°C to +60°C	-25°C to +60°C
Climatic resistance acc. to IEC 60068-2-78	Damp heat, constant		
acc. to IEC 60068-2-30	Damp heat, cyclic		
Pollution degree2	2	2	
Operating cycles mechanical	100.000	100.000	100.000
Operating cycles mechanical per hour	≤120	≤120	≤120

Dimensions (mm)

P-SOL20

P-SOL30

P-SOL60

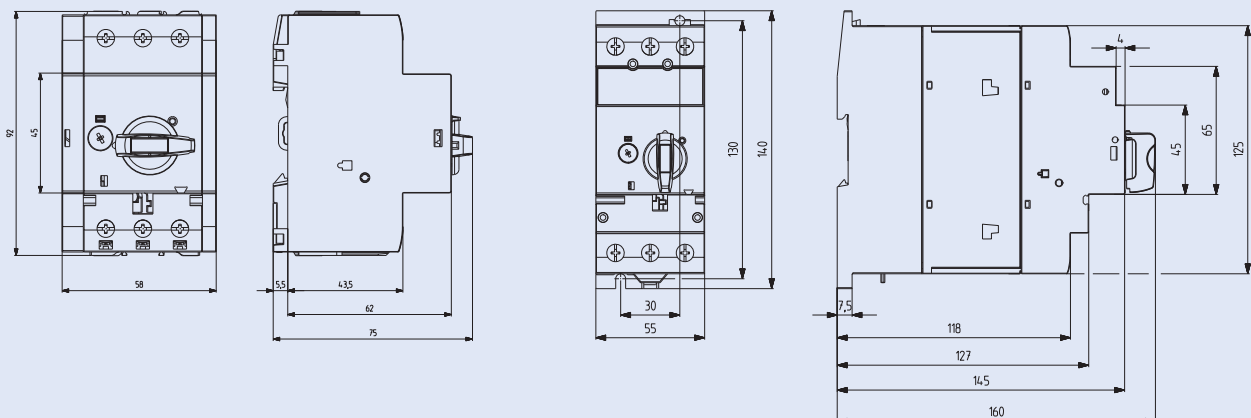

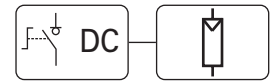

DC Switch-disconnector SOL as pre-wired unit

- Field of application:
DC-Disconnection in photovoltaic systems between PV Array and Inverter to switch off the energy
- Pre-wired unit ready for connection
- Lock-able in OFF-position with a padlock
- Any mounting position
- Spring work contacts
- Tested according to IEC/EN 60947-3, UL508
- Certificate TÜV-Rheinland

Connection diagram

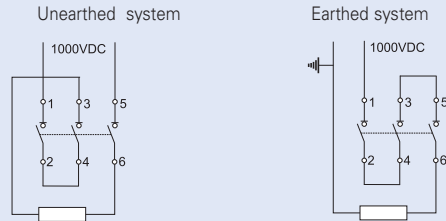

Technical Data

	SOL20	SOL30
Electrical		
Number of poles	2	2
Rated operational voltage U_e	1000 VDC	1000 VDC
Rated operational current I_e	20 A	30 A
Rated short-circuit making capacity I_{cm}	500 A	500 A
Rated short-time withstand current 1sec. I_{cw}	700 A	700 A
Utilization category	DC-21 A	DC-21 A
Overvoltage category	III	III
Rated impulse withstand voltage U_{imp}	8 kV	8 kV
Operating cycles electrical at U_e and I_e	1500	1500
Internal resistance	8m Ω	5m Ω

Mechanical		
Weight	420 g	420 g
Degree of protection	IP65	IP65
Ambient temperature range	-25°C to +60°C	-25°C to +60°C
Climatic resistance acc. to 60068-2-78	Damp heat, constant	
acc. to 60068-2-30	Damp heat, cyclic	
Pollution degree	3	3
Operating cycles mechanical	100.000	100.000
Operating cycles mechanical per hour	≤120	≤120

Dimensions (mm)

SOL20(30)	a [mm]
MC4	234
MV	224

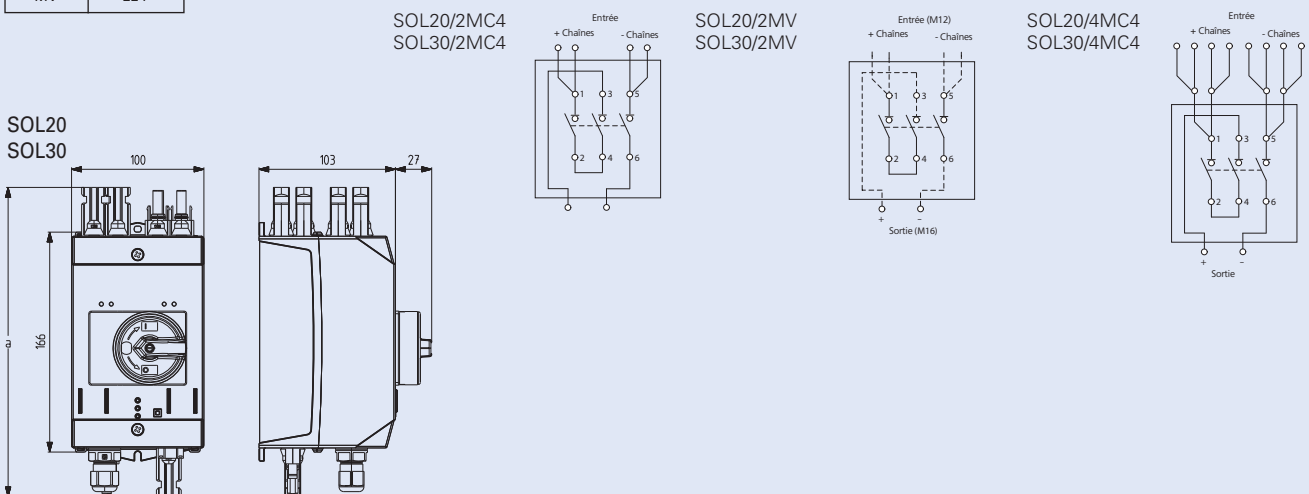

Photovoltaic - DC String Protection

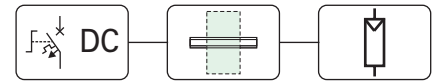

DC-String Circuit Breaker PKZ-SOL

- Field of application:
DC-Circuit breaker for string protection in photovoltaic systems
- No polarity
- Spring work contacts
- Tested according to IEC/EN 60947-2
- Certificate TÜV-Rheinland

Connection diagram

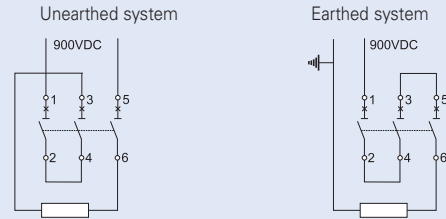

Technical Data

PKZ-SOL4
PKZ-SOL7
PKZ-SOL12
PKZ-SOL20
PKZ-SOL30

Electrical

Number of poles	2
Rated operational voltage U_e	900 VDC
Rated current I_n	4 / 7 / 12 / 20 / 30 A
Thermal tripping characteristic	1.05 to 1.3 x I_n
Electromagnetic tripping characteristic	6 x I_n
Rated ultimate short-circuit breaking capacity I_{cu}	5 kA
Rated service short-circuit breaking capacity I_{cs}	1.5 kA
Overvoltage category	III
Rated impulse withstand voltage U_{imp}	8 kV
Operating cycles electrical at U_e and I_n	1500
Internal resistance	138 / 60 / 32 / 14 / 9 mΩ

Mechanical

Width	58
Height	93
Depth	76
Weight	265 g
Mounting quick fastening on DIN rail acc. to IEC/EN 60517	35 mm
Screw fastening	
Degree of protection	IP20
Terminal capacity Flexible with end sleeve mm ²	2x (1-6)
AWG	18-10
Tightening torque of terminal screws	1,7 Nm
Ambient temperature range	-25°C to +60°C
Climatic resistance acc. to IEC 60068-2-78	Damp heat, constant
acc. to IEC 60068-2-30	Damp heat, cyclic
Pollution degree	2
Operating cycles mechanical	100.000
Operating cycles mechanical per hour	≤120

Mounting position

PKZ-SOL4
PKZ-SOL7
PKZ-SOL12
PKZ-SOL20
PKZ-SOL30

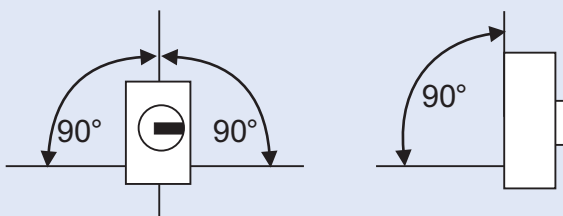

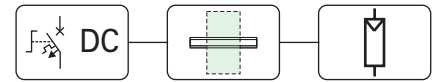

DC-String Circuit Breaker PKZ-SOL

Characteristic curve setting value - Short-circuit current

According to the design for IEC 62548-1, the tripping current for the circuit breaker must fall within a range of 1.4 to 2 times the value of the short-circuit current of the PV modules, in order to protect the PV modules.

Since only the current values for the built-in overload tripping device can be plotted on the setting scale of the circuit breaker¹⁾, the correlation between the tripping current for the safety device and the short-circuit current for the PV modules must be properly indicated for every point of the scale.

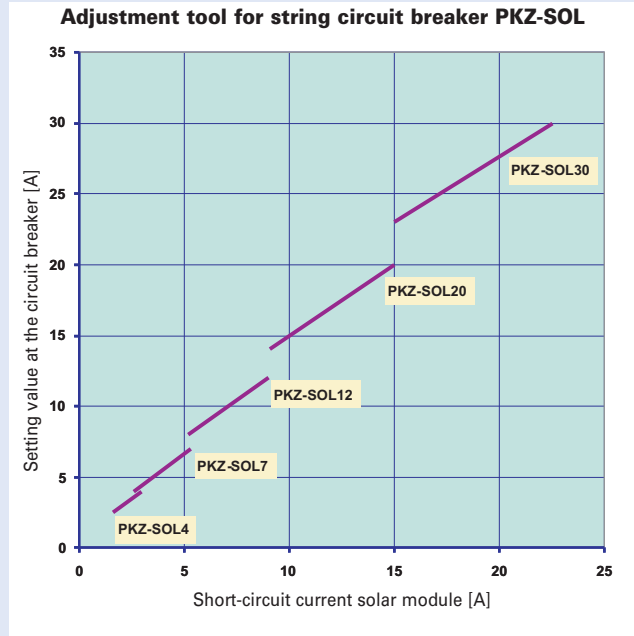
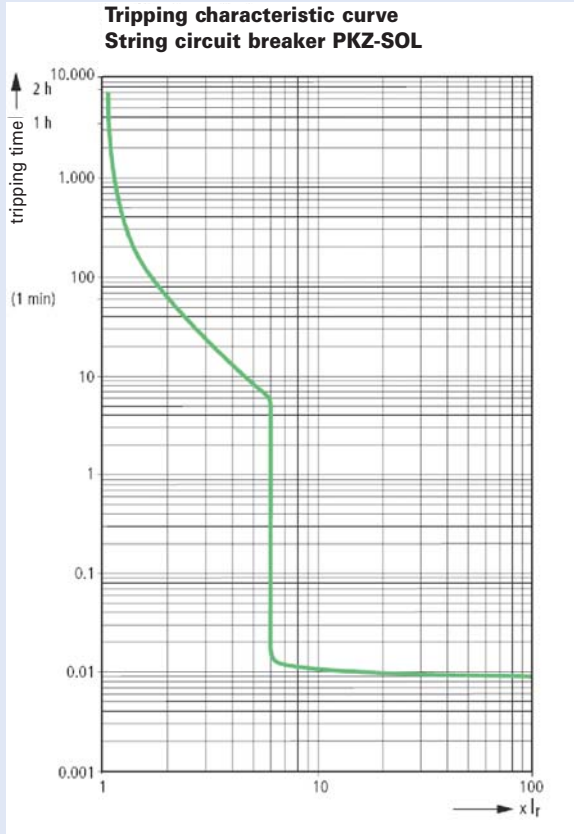

¹⁾ Norm IEC/EN 60947-2 (section 4.7.3) prohibits a direct specification of the PV short-circuit current on the circuit breaker's setting scale, whereby only the setting value for the response current may be entered.

Dimensions (mm)

- PKZ-SOL4
- PKZ-SOL7
- PKZ-SOL12
- PKZ-SOL20
- PKZ-SOL30

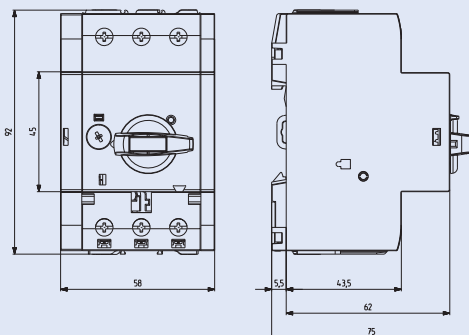

Photovoltaik - Surge Protection

SG29612



SPBT12-280/3

sg52112



SP-B+C/3+1

SG53712



Lightning current arrester - surge arrester Sets, Lightning protection classes III, IV

Description	Type Designation	Article No.	Units per package
Without remote indication			
TN-S/TT-Set 1+1-pole	SPBT12-280-1+NPE	158308	1 / 40
TN-S-Set 2-pole	SPBT12-280/2	158309	1 / 60
TN-C-Set 3-pole	SPBT12-280/3	158330	1 / 40
TN-S-Set 4-pole	SPBT12-280/4	158331	1 / 30
TN-S/TT-Set 3+1-pole	SPBT12-280-3+NPE	158332	1 / 20
TN-S/TT-Set 3+1-pole	SPBT12-280-3+NPE/BB	158333	1
With remote indication			
TN-S/TT-Set 1+1-pole	SPBT12-280-1+NPE-AX	158334	1 / 30
TN-S/TT-Set 3+1-pole	SPBT12-280-3+NPE-AX	158335	1
Accessories			
Auxiliary switch for SPBT12-280	ASAUWSC-SPM	131785	4 / 120
Busbar	ZV-KSBI...		

Lightning current arrester - surge arrester Sets, Lightning protection classes I, II, III, IV

Description	Type Designation	Article No.	Units per package
SPD Class B+C, SP-B+C/			
TN-C-Set 3-pole	SP-B+C/3	267489	1
TN-S/TT-Set 3+1-pole	SP-B+C/3+1	267510	1
Accessories			
Auxiliary switch for SP-B+C	ASAUWSC-SPM	131785	8 / 80

Photovoltaik - Surge Protection

SG13109



SPCT2-280

SG50112



SPCT2-280/3

Plug-in surge arrester SPCT2

Insert 1-pole

Insert 75VAC	20kA	SPCT2-075	167577	4/120
Insert 130VAC	20kA	SPCT2-130	167582	4/120
Insert 175VAC	20kA	SPCT2-175	167587	4/120
Insert 280VAC	20kA	SPCT2-280	167592	4/120
Insert 335VAC	20kA	SPCT2-335	167597	4/120
Insert 385VAC	20kA	SPCT2-385	167602	4/120
Insert 460VAC	20kA	SPCT2-460	167607	4/120
Insert 580VAC	20kA	SPCT2-580	167612	4/120
Insert 260VAC	30kA	SPCT2-NPE60	167617	4/120

Plug-in surge arrester SPCT2, 1- to 4-pole

Complete (2- and multi-pole surge arresters are supplied with busbar)

1-pole	75VAC	20kA	SPCT2-075/1	167578	12/120
1-pole	130VAC	20kA	SPCT2-130/1	167583	12/120
1-pole	175VAC	20kA	SPCT2-175/1	167588	12/120
1-pole	280VAC	20kA	SPCT2-280/1	167593	12/120
1-pole	335VAC	20kA	SPCT2-335/1	167598	12/120
1-pole	385VAC	20kA	SPCT2-385/1	167603	12/120
1-pole	460VAC	20kA	SPCT2-460/1	167608	12/120
1-pole	580VAC	20kA	SPCT2-580/1	167613	12/120
1+N	260VAC	30kA	SPCT2-NPE60/1	167618	12/120
2-pole	75VAC	2x20kA	SPCT2-075/2	167579	1/60
2-pole	130VAC	2x20kA	SPCT2-130/2	167584	1/60
2-pole	175VAC	2x20kA	SPCT2-175/2	167589	1/60
2-pole	280VAC	2x20kA	SPCT2-280/2	167594	1/60
2-pole	335VAC	2x20kA	SPCT2-335/2	167599	1/60
2-pole	385VAC	2x20kA	SPCT2-385/2	167604	1/60
2-pole	460VAC	2x20kA	SPCT2-460/2	167609	1/60
2-pole	580VAC	2x20kA	SPCT2-580/2	167614	1/60
3-pole	75VAC	3x20kA	SPCT2-075/3	167580	1/40
3-pole	130VAC	3x20kA	SPCT2-130/3	167585	1/40
3-pole	175VAC	3x20kA	SPCT2-175/3	167590	1/40
3-pole	280VAC	3x20kA	SPCT2-280/3	167595	1/40
3-pole	335VAC	3x20kA	SPCT2-335/3	167600	1/40
3-pole	385VAC	3x20kA	SPCT2-385/3	167605	1/40
3-pole	460VAC	3x20kA	SPCT2-460/3	167610	1/40
3-pole	580VAC	3x20kA	SPCT2-580/3	167615	1/40
4-pole	75VAC	4x20kA	SPCT2-075/4	167581	1/30
4-pole	130VAC	4x20kA	SPCT2-130/4	167586	1/30
4-pole	175VAC	4x20kA	SPCT2-175/4	167591	1/30
4-pole	280VAC	4x20kA	SPCT2-280/4	167596	1/30
4-pole	335VAC	4x20kA	SPCT2-335/4	167601	1/30
4-pole	385VAC	4x20kA	SPCT2-385/4	167606	1/30
4-pole	460VAC	4x20kA	SPCT2-460/4	167611	1/30
4-pole	580VAC	4x20kA	SPCT2-580/4	167616	1/30
1+N	280VAC	20kA	SPCT2-280-1+NPE	167619	1/60
1+N	335VAC	20kA	SPCT2-335-1+NPE	167621	1/60
1+N	385VAC	20kA	SPCT2-385-1+NPE	167623	1/60
1+N	460VAC	20kA	SPCT2-460-1+NPE	167625	1/60
1+N	580VAC	20kA	SPCT2-580-1+NPE	167627	1/60
3+N	280VAC	20kA	SPCT2-280-3+NPE	167620	1/30
3+N	335VAC	20kA	SPCT2-335-3+NPE	167622	1/30
3+N	385VAC	20kA	SPCT2-385-3+NPE	167624	1/30
3+N	460VAC	20kA	SPCT2-460-3+NPE	167626	1/30
3+N	580VAC	20kA	SPCT2-580-3+NPE	167628	1/30
3+N/BB	280VAC	3x20kA	SPCT2-280-3+NPE/BB	167629	1
3+N/BB	335VAC	3x20kA	SPCT2-335-3+NPE/BB	167630	1
3+N/BB	385VAC	3x20kA	SPCT2-385-3+NPE/BB	167631	1
3+N/BB	460VAC	3x20kA	SPCT2-460-3+NPE/BB	167632	1

Photovoltaik - Surge Protection

SPD Class B+C, Lightning Current Arrester - Surge Arresters SPBT12

- Field of application
For the protection of low voltage distribution systems against transient overvoltage caused by direct and indirect lightning stroke and switching operations.
- Application according to IEC 60364-5-53 Clause 534
- Test class **I**, **II** in accordance with IEC 61643-1
- SPD-type **T1**, **T2** in accordance with EN 61643-11
- Lightning protection classes III and IV in accordance with IEC 62305
- Busbars ZV-KSBI are available for all customary applications

Block Diagram



Technical Data

	SPBT12-280...	SPBT12-NPE100
Electrical	per pole	
Responding time (rate of voltage rise 5 kV/μs)	< 25 ns	< 100 ns
Voltage protection level U_p	< 1.5kV	< 1.5kV
Voltage protection level at 5 kA (8/20) μs	950 V	-
Maximum continuous operating voltage U_c	280 VAC	255 VAC
Temporary overvoltage test value U_T	370 VAC (5 s)	1200 VAC (200 ms)
Rated frequency	50/60 Hz	50/60 Hz
Open circuit voltage U_{oc}	10 kV	20 kV
Nominal discharge current (8/20) μs I_n	25 kA	100 kA
Maximum discharge current I_{max}	50 kA	100 kA
Impulse current I_{imp} (10/350) μs		
Peak current	12.5 kA	100 kA
Charge Q	6.25 As	50 As
Specific energy	39.1 kJ/Ω	2500 kJ/Ω
Follow current interrupt rating I_{fi}	-	100 A _{r.m.s}
Maximum back-up fuse	160 AgL/gG	-
Maximum short-circuit current	50 kA _{r.m.s}	-
Connection diagram		

Mechanical

Frame size	45 mm	45 mm
Device height	80 mm	80 mm
Device width	17.5 mm	35 mm
Weight	121 g	250 g
Permitted ambient temperature	-40°C to +70°C	-40°C to +70°C
Degree of protection (built-in)	IP40	IP40
Upper and lower lift terminal capacity	4 - 25 mm ²	4 - 35 mm ²
Upper and lower open mouthed terminals for busbar thickness up to	1.5 mm	1.5 mm
Tightening torque of terminal screws	2.4 - 3 Nm	2.4 - 3 Nm
Quick fastening on DIN rail according to	IEC/EN 60715	IEC/EN 60715
Accessories: busbars 16 mm ²	Type ZV-KSBI ...	Type ZV-KSBI ...

Dimensions (mm)

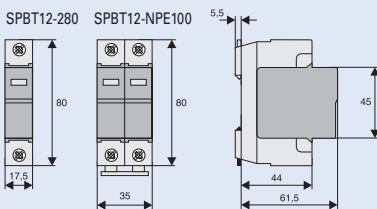

Lightning current arrester - surge arrester Sets, Lightning protection classes III, IV

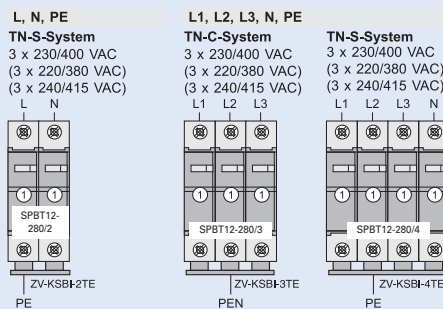

① ...SPBT12-280

Photovoltaik - Surge Protection

SPD Class B+C, Lightning Current Arrester - Surge Arresters SPBT12-280

- Field of application
For the protection of low voltage distribution systems against transient overvoltage caused by direct and indirect lightning stroke and switching operations.
- Application according to IEC 60364-5-53 Clause 534
- Test class **I**, **II** in accordance with IEC 61643-1
- SPD-type **T1**, **T2** in accordance with EN 61643-11
- Lightning protection classes III and IV in accordance with IEC 62305
- Busbars ZV-KSBI are available for all customary applications

Block Diagram



Technical Data

		SPBT12-280-1+NPE	SPBT12-280-3+NPE
Electrical		per pole	
Responding time (rate of voltage rise 5 kV/μs)	L-N / N-PE	< 25 ns / < 100 ns	< 25 ns / < 100 ns
Voltage protection level U_p	L-N / L-PE / N-PE	< 1.5kV	< 1.5kV
Maximum continuous operating voltage U_C	L-N / N-PE	280 VAC / 255 VAC	280 VAC / 255 VAC
Temporary overvoltage test value U_T (5 s)	L-N / L-PE	348 VAC / 370 VAC	348 VAC / 370 VAC
	N-PE	1200 VAC	1200 VAC
Rated frequency		50/60 Hz	50/60 Hz
Open circuit voltage U_{oc}		10 kV	20 kV
Nominal discharge current (8/20) μs I_n	L-N / N-PE	25 kA / 100 kA	3x25 kA / 100 kA
Maximum discharge current I_{max}	L-N / N-PE	50 kA / 100 kA	3x50 kA / 100 kA
Impulse current I_{imp} (10/350) μs			
	Peak current	L-N / N-PE	12.5 kA / 100 kA
Charge Q		50 As	50 As
Specific energy		2500 kJ/Ω	2500 kJ/Ω
Follow current interrupt rating I_{fi}	N-PE	100 A _{r.m.s}	100 A _{r.m.s}
Maximum back-up fuse		160 AgL/gG	160 AgL/gG
Maximum short-circuit current		50 kA _{r.m.s}	50 kA _{r.m.s}
Connection diagram			
Mechanical			
Frame size		45 mm	45 mm
Device height		80 mm	80 mm
Device width		52.5 mm	87.5 mm
Weight		375 g	626 g
Permitted ambient temperature		-40°C to +70°C	-40°C to +70°C
Degree of protection (built-in)		IP40	IP40
Upper and lower lift terminal capacity	L, N	4 - 25 mm ²	4 - 25 mm ²
	N, PE	4 - 35 mm ²	4 - 35 mm ²
Upper and lower open mouthed terminals for busbar thickness up to		1.5 mm	1.5 mm
Tightening torque of terminal screws		2.4 - 3 Nm	2.4 - 3 Nm
Quick fastening on DIN rail according to		IEC/EN 60715	IEC/EN 60715
Accessories: busbars 16 mm ²		Type ZV-KSBI ...	Type ZV-KSBI ...

Lightning current arrester - surge arrester Sets, Lightning protection classes III, IV

<p>L, N, PE TN-S-System 3 x 230/400 VAC (3 x 220/380 VAC) (3 x 240/415 VAC)</p> <p>SPBT12-280-1+NPE</p>	<p>L1, L2, L3, N, PE TN-S/TT-System 3 x 230/400 VAC (3 x 220/380 VAC) (3 x 240/415 VAC)</p> <p>SPBT12-280-3+NPE</p>	<p>TN-S/TT-System 3 x 230/400 VAC (3 x 220/380 VAC) (3 x 240/415 VAC)</p> <p>SPBT12-280-3+NPE/BB</p>	<p>L, N, PE TN-S-System 3 x 230/400 VAC (3 x 220/380 VAC) (3 x 240/415 VAC)</p> <p>SPBT12-280-1+NPE-AX</p>	<p>L1, L2, L3, N, PE TN-S/TT-System 3 x 230/400 VAC (3 x 220/380 VAC) (3 x 240/415 VAC)</p> <p>SPBT12-280-3+NPE-AX</p>	<p>① ...SPBT12-280 ② ...ASAUXSC-SPM ③ ...SPI-100/NPE ④ ...ASLTT-63</p>
---	---	---	--	--	--

Photovoltaik - Surge Protection

SPD Class C, Plug-in Surge Arresters SPCT2

- Field of application:
For the protection of low voltage distribution systems against transient overvoltage caused by indirect lightning stroke and switching operations.
- Test class **II** according to IEC 61643-1+A1
- SPD-type **T2** according to EN 61643-11
- Auxiliary switch SPC-S-HK for remote message transmission can be mounted onto the device
- Suitable for busbar connection to all Xtra Combinations switchgear
- Busbars ZV-KSBI are available for all customary applications

Symbol

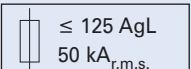
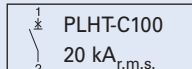

Technical Data

Inserts	SPCT2-075	SPCT2-130	SPCT2-175	SPCT2-280	SPCT2-335	SPCT2-385	SPCT2-460
Electrical							
Mechanical coding	x	x	x	x	x	x	x
Responding time (rate of voltage rise 5 kV/μs)	< 25 ns	< 25 ns	< 25 ns	< 25 ns	< 25 ns	< 25 ns	< 25 ns
Voltage protection level at nominal discharge current / U_{oc}	< 550 V	< 800 V	< 1.0 kV	< 1.4 kV	< 1.6 kV	< 1.8 kV	< 2.2 kV
Voltage protection level at 5 kA (8/20) μs	400 V	550 V	700 V	1000 V	1200 V	1350 V	1700 V
Maximum continuous operating voltage U_c	75 VAC	130 VAC	175 VAC	280 VAC	335 VAC	385 VAC	460 VAC
Temporary overvoltage test value U_T (5 s)	= U_c	= U_c	= U_c	350 VAC	415 VAC	415 VAC	580 VAC
Rated frequency	50/60 Hz	50/60 Hz	50/60 Hz	50/60 Hz	50/60 Hz	50/60 Hz	50/60 Hz
Open circuit voltage U_{oc}	–	–	–	10 kV	5 kV	–	–
Nominal discharge current (8/20) μs I_n	15 kA	20 kA	15 kA	20 kA	20 kA	20 kA	20 kA
Charge Q at I_n	0.43 As	0.57 As	0.57 As	0.57 As	0.57 As	0.57 As	0.57 As
Specific energy at I_n	3.2 kJ/Ω	5.7 kJ/Ω	5.7 kJ/Ω	5.7 kJ/Ω	5.7 kJ/Ω	5.7 kJ/Ω	5.7 kJ/Ω
Maximum discharge current I_{max}	30 kA	40 kA	40 kA	40 kA	40 kA	40 kA	40 kA
Follow current interrupt rating I_{fi}	–	–	–	–	–	–	–
Permissible back-up fuse							
Maximum short-circuit current	50 kA _{r.m.s.}		20 kA _{r.m.s.}				

Connection diagram

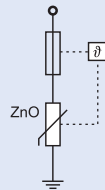

Mechanical

Frame size	45 mm
Device height	80 mm
Device width	
1-pole	17.5 mm (1MU)
1+1-pole	35 mm (2MU)
2-pole	35 mm (2MU)
3-pole	52.5 mm (3MU)
3+1-pole	70 mm (4MU)
4-pole	70 mm (4MU)
Mechanical coding	
1-pole	x
1+1-pole	yx
2-pole	xx
3-pole	xxx
3+1-pole	yxxx
4-pole	xxxx
Weight Base 1P, 1+1P, 2P, 3P, 3+1P, 4P	53/120/120/180/240/240 g
Weight Complete Devices 1P, 1+1P, 2P, 3P, 3+1P, 4P	110/201/220/330/412/440 g
Permitted ambient temperature	-40°C to +70°C
Degree of protection (built-in)	IP40
Upper and lower lift terminal capacity	4 - 25 mm ²
Upper and lower open mouthed terminals for busbar thickness up to	1.5 mm
Tightening torque of terminal screws	2.4 - 3 Nm
Quick fastening on DIN rail according to	IEC/EN 60715
Accessories: busbars 16 mm ²	Type ZV-KSBI ...

Photovoltaik - Surge Protection

Technical Data

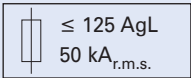
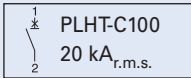
Inserts	SPCT2-580	SPCT2-NPE
Electrical		
Mechanical coding	x	y
Responding time (rate of voltage rise 5 kV/ μ s)	< 25 ns	< 100 ns
Voltage protection level at nominal discharge current / U_{oc}	< 2.6 kV	< 1.0 kV
Voltage protection level at 5 kA (8/20) μ s	2000 V	-
Maximum continuous operating voltage U_c	580 VAC	260 VAC
Temporary overvoltage test value U_T	= U_c (5 s)	1200 VAC (200 ms)
Rated frequency	50/60 Hz	50/60 Hz
Nominal discharge current (8/20) μ s I_n	20 kA	20 kA
Charge Q at I_n	0.57 As	0.57 As
Specific energy at I_n	5.7 kJ/ Ω	5.7 kJ/ Ω
Maximum discharge current I_{max}	40 kA	40 kA
Follow current interrupt rating I_{fi}	-	100 A _{r.m.s}
Permissible back-up fuse		-
Maximum short-circuit current		

Connection diagram

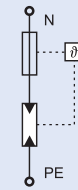
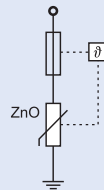

Mechanical

Frame size	45 mm
Device height	80 mm
Device width	
1-pole	17.5 mm (1MU)
1+1-pole	35 mm (2MU)
2-pole	35 mm (2MU)
3-pole	52.5 mm (3MU)
3+1-pole	70 mm (4MU)
4-pole	70 mm (4MU)
Mechanical coding	
1-pole	x
1+1-pole	yx
2-pole	xx
3-pole	xxx
3+1-pole	yxxx
4-pole	xxxx
Weight Base 1P, 1+1P, 2P, 3P, 3+1P, 4P	53/120/120/180/240/240 g
Weight Complete Devices 1P, 1+1P, 2P, 3P, 3+1P, 4P	110/201/220/330/412/440 g
Permitted ambient temperature	-40°C to +70°C
Degree of protection (built-in)	IP40
Upper and lower lift terminal capacity	4 - 25 mm ²
Upper and lower open mouthed terminals	
for busbar thickness up to	1.5 mm
Tightening torque of terminal screws	2.4 - 3 Nm
Quick fastening on DIN rail according to	IEC/EN 60715
Accessories: busbars 16 mm ²	Type ZV-KSBI ...

Dimensions (mm)

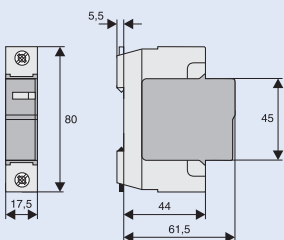

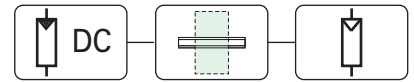

SPD-type T2 (Class C)

Max. Cont. Op. Volt. U_C I_n (Type Designation	Article No.	Units per package
------------------------------------	------------------	-------------	-------------------

Plug-in Surge Arrester SPPT2PA for Photovoltaic application

For earthed systems

600 V DC	SPPT2PA-600-2PE	132663	1 / 60
1000 V DC	SPPT2PA-1000-2PE	132664	1 / 60
with auxiliary switch			
1000 V DC	SPPT2PA-1000-2PE-AX	132666	1 / 60

For unearthed systems

600 V DC	SPPT2PA-600-2+1PE	132661	1 / 40
1000 V DC	SPPT2PA-1000-2+1PE	132662	1 / 40
with auxiliary switch			
1000 V DC	SPPT2PA-1000-2+1PE-AX	132665	1 / 40

Inserts for replacement

600 V DC	①	SPPT2PA-600	132667	1
1000 V DC	①	SPPT2PA-1000	132668	1
1100 V DC	②	SPPT2PA-1100	132669	1

$V_{oc} \leq U_c$: Open circuit voltage of PV-Generator shall be equal or less than maximum continuous operating voltage of Surge Protective Device (SPD) to prevent its damage.

V_{oc} Open circuit voltage of PV-Generator.

U_c Maximum continuous operating voltage of SPD.

⚡ Attention: Even at switched off DC-Disconnecter system stays under high voltage! Before mounting ensure de-energizing and check zero-potential.

SG11009



SG11309



sg62612



Earthed system

SPPT2PA-600-2PE
SPPT2PA-1000-2PE(-AX)

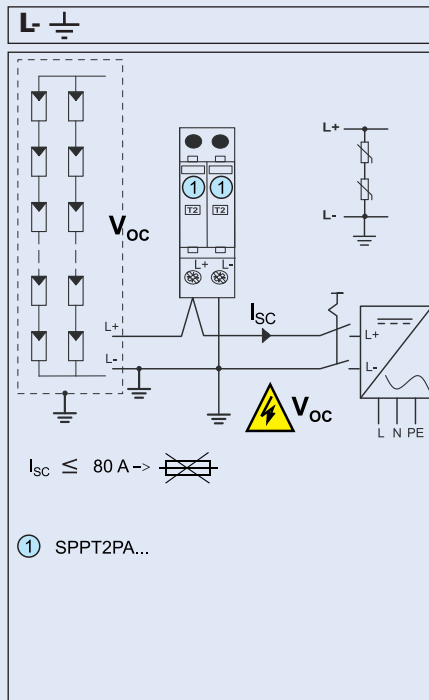

Unearthed system

SPPT2PA-600-2+1PE
SPPT2PA-1000-2+1PE(-AX)

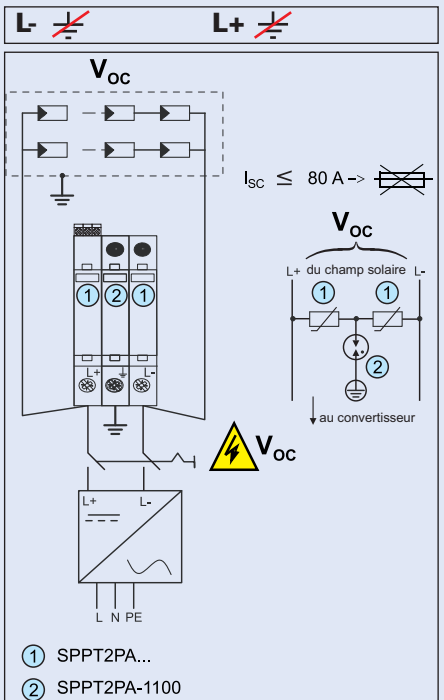

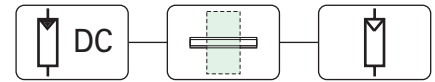

SPD-type T2 (Class C), Plug-in Surge Arresters SPPT2PA-...-2PE

- Field of application:
For the protection of photovoltaic systems against transient overvoltage caused by indirect lightning stroke and switching operations.
- Test class **II** according to IEC 61643-1
- SPD-type **T2** according to EN 61643-11
- Types SPPT2PA-...-AX for remote message transmission of defective inserts

Connection diagrams

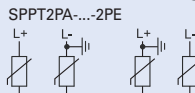

Technical Data

	SPPT2PA-600-2PE	SPPT2PA-1000-2PE(-AX)
Electrical		
Responding time	≤ 25 ns	≤ 25 ns
Maximum continuous operating voltage U_C	600 V DC	1000 V DC
Rated frequency	DC	DC
Nominal discharge current I_n	15 kA (8/20) μ s	15 kA (8/20) μ s
Voltage protection level U_p	≤ 3 kV	≤ 5 kV
Residual voltage at 5 kA (8/20) μ s	≤ 2.5 kV	≤ 4 kV
Maximum discharge current I_{max}	30 kA (8/20) μ s	30 kA (8/20) μ s
Permissible back-up fuse	-	-
Maximum short-circuit current I_{sc}	80 A	80 A
Residual current I_{PE}	≤ 20 μ A	≤ 20 μ A
Mechanical		
Frame size	45 mm	45 mm
Device height	90 mm	90 mm (99 mm)
Device width	35.6 mm	35.6 mm
Weight	247 g	247 g (249 g)
Upper and lower lift terminal capacity fine- / solid strand	4-25/4-35 mm ² /AWG11-2	4-25/4-35 mm ² /AWG11-2
Tightening torque of terminal screws	4.5 Nm	4.5 Nm
Permitted ambient temperature	-40°C up to +80°C	-40°C up to +80°C
Mounting	quick fastening on DIN rail IEC/EN 60715	
Degree of protection	IP20	IP20
Polution degree	2	2

Auxiliary switch

Electrical	
Rated insulation voltage	250 V
Rated frequency	50/60 Hz
Switching contact	1 CO
Minimum voltage per contact	5 V AC/DC
Rated operational current	1.5 A / 250 V AC 1.5 A / 30 V DC
Min. admissible power	5 mA / 5 V

Mechanical	
Terminal capacity fine- / solid strand	1.5/1.5 mm ² /AWG28-16
Tightening torque of terminal screws	0.25 Nm

Dimensions (mm)

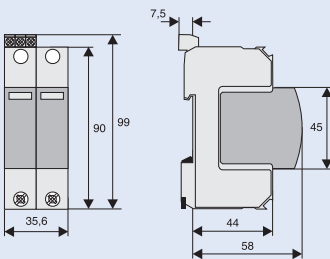

Application hints according to EN 50539-12

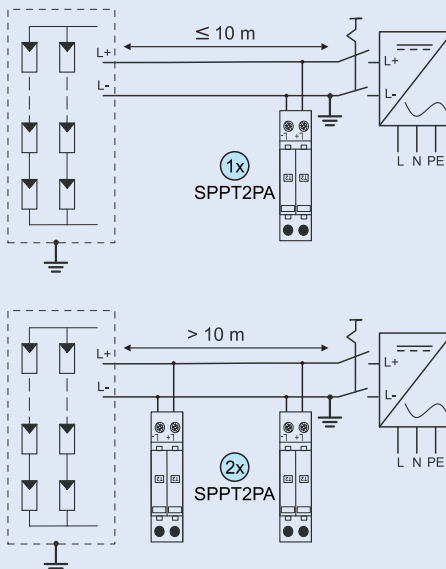

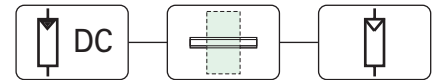

SPD-type T2 (Class C), Plug-in Surge Arresters SPPT2PA-...-2+1PE

- Field of application:
For the protection of photovoltaic systems against transient overvoltage caused by indirect lightning stroke and switching operations.
- Test class **II** according to IEC 61643-1
- SPD-type **T2** according to EN 61643-11
- Galvanic separation in unearthed systems by means of a spark gap
- Types SPPT2PA-...-AX for remote message transmission of defective inserts

Connection diagrams

SPPT2PA-...-2+1PE

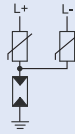

Technical Data

		SPPT2PA-600-2+1PE	SPPT2PA-1000-2+1PE(-AX)
Electrical			
Responding time	L+ -> L- / L- -> PE	≤ 25 ns / ≤ 100 ns	≤ 25 ns / ≤ 100 ns
Maximum continuous operating voltage U_C		600 V DC	1000 V DC
Rated frequency		DC	DC
Nominal discharge current I_n		15 kA (8/20) μ s	15 kA (8/20) μ s
Voltage protection level U_p	L+ -> L- / L- -> PE	≤ 3 kV / ≤ 3 kV	≤ 5 kV / ≤ 3 kV
Residual voltage at 5 kA (8/20) μ s	L+ -> L- / L- -> PE	≤ 2.5 kV / ≤ 2 kV	≤ 4 kV / ≤ 2 kV
Maximum discharge current I_{max}		30 kA (8/20) μ s	30 kA (8/20) μ s
Permissible back-up fuse		-	-
Maximum short-circuit current I_{sc}		80 A	80 A
Residual current I_{PE}		≤ 20 μ A	≤ 20 μ A

Mechanical

Frame size		45 mm	45 mm
Device height		90 mm	90 mm (99 mm)
Device width		53.4 mm	53.4 mm
Weight		318 g	318 g (323 g)
Upper and lower lift terminal capacity fine- / solid strand		4-25/4-35 mm ² /AWG11-2	4-25/4-35 mm ² /AWG11-2
Tightening torque of terminal screws		4.5 Nm	4.5 Nm
Permitted ambient temperature		-40°C up to +80°C	-40°C up to +80°C
Mounting		quick fastening on DIN rail IEC/EN 60715	
Degree of protection		IP20	IP20
Polution degree		2	2

Auxiliary switch

Electrical

Rated insulation voltage	250 V
Rated frequency	50/60 Hz
Switching contact	1 CO
Minimum voltage per contact	5 V AC/DC
Rated operational current	1.5 A / 250 V AC 1.5 A / 30 V DC
Min. admissible power	5 mA / 5 V

Mechanical

Terminal capacity fine- / solid strand	1.5/1.5 mm ² /AWG28-16
Tightening torque of terminal screws	0.25 Nm

Dimensions (mm)

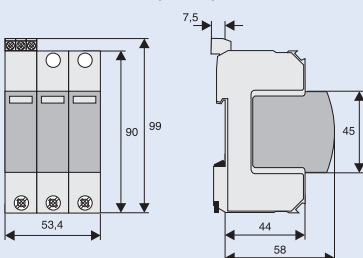

Application hints according to EN 50539-12

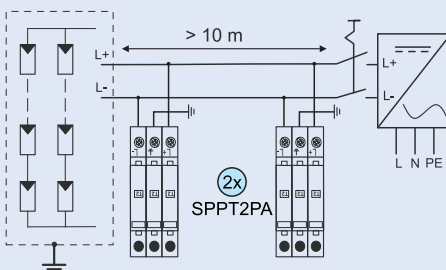
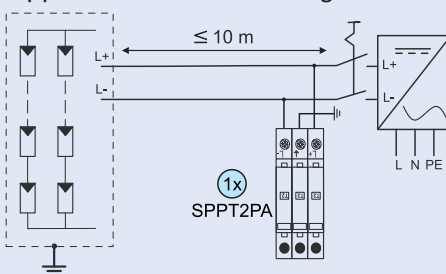

Ci Insulated Enclosures

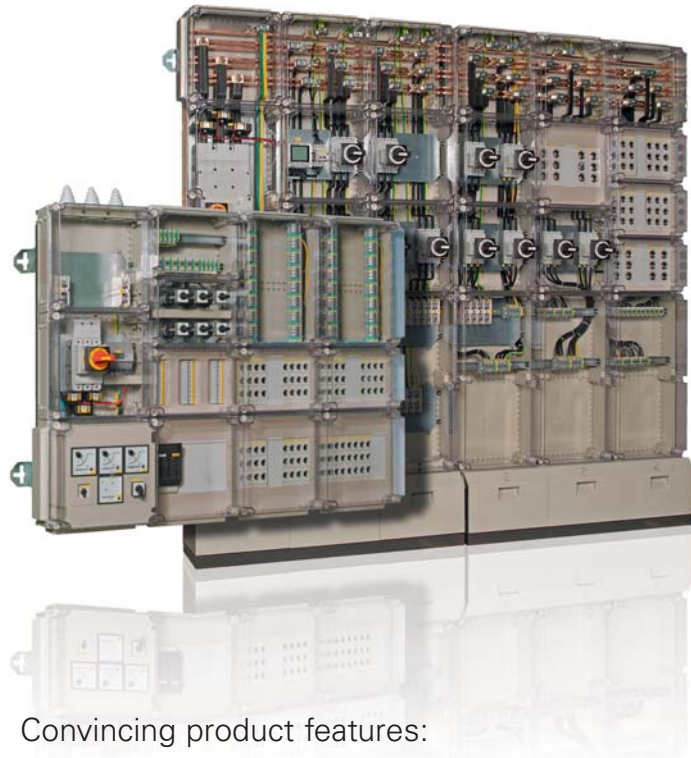

Convincing product features:





- High IP65 degree of protection
- Total insulation
- Polycarbonate
- Distribution system based on a 25 mm grid
- Modular system
- over resting on 4 spring-loaded fittings
- Stable carrier-frame profiles
- Captive, foamed sealings
- Wedge-type connectors made of insulating material to interconnect the enclosures
- Transparent covers
- Consistent system for up to 1600 A







Advantages to get excited about:

- A distribution system for universal use
- Highest standard in terms of safety for people and operation
- Many combination options based on a reduced number of modules
- Easy to expand when necessary
- Degree of protection is guaranteed regardless of an operator's level of care and attention
- Entirely encapsulating insulation-material for high protection against corrosion
- No special tools required
- No carrying over of voltage to adjacent enclosures
- Easier maintenance and system control
- Complete solution for low-voltage distribution from a single supplier

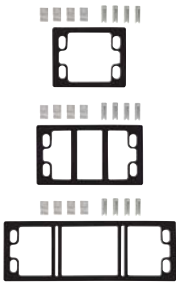
Ci Insulated Enclosures

Distribution enclosure

Size	Ci23	Ci43	Ci44	Ci45	Ci48
Dimensions [mm]	187,5 x 250	375 x 250	375 x 375	375 x 500	375 x 750
Distribution enclosure					
Installation depth [mm]	125/150	125/150/200	125/150/200/250	200	200/250
	Ci23-125 098208	Ci43-125 017527	Ci44-125 012452	Ci45-200 001896	Ci48-200 078896
	Ci23-150 012781	Ci43-150 022273	Ci44-150 017198		Ci48-250 083642
		Ci43-200 027019	Ci44-200 021944		
			Ci44-250 026690		

Size	Ci23	Ci43	Ci44	Ci48	Verbindungssätze für Zusammenbau
Dimensions [mm]	187,5 x 250	375 x 250	375 x 375	375 x 750	
Distribution enclosure with cable fitting					
Installation depth [mm]	125/150	125/150/200	125/150/200/250	200/250	
	KST32-125 069774	KST34-125 076893	KST44-125 088758	KST48-200 098250	BS2-Ci 090750
	KST32-150 072147	KST34-150 074520	KST44-150 091131	KST48-250 010450	BS3-Ci 097869
		KST34-200 079266	KST44-200 093504		BS4-Ci 014815
		KST43-125 081639	KST44-250 095877	Cross-strut kits	Flange spreader
		KST43-150 084012			
		KST43-200 086385		STB3-Ci 219217	FT-Ci 02319
				STB4-Ci 034223	

The complete range of almost 700 well co-ordinated products for the Ci programme is available in our Eaton online catalogue.

Ci Insulated Enclosures

Stand-alone enclosures

Size	Ci23	Ci43	Ci44	Ci45
Dimensions [mm]	187,5 x 250	375 x 250	375 x 375	375 x 500

Stand-alone enclosures E



Installation depth [mm]	125/150	125/150/200	125/150/200/250	200
	Ci23E-125 019570	Ci43E-125 093133	Ci44E-125 031436	Ci45E-200 001891
	Ci23E-150 021943	Ci43E-150 095506	Ci44E-150 033809	
		Ci43E-200 097879	Ci44E-200 036182	
			Ci44E-250 038555	

Size	Ci23	Ci43	Ci44	Ci45
Dimensions [mm]	187,5 x 250	375 x 250	375 x 375	375 x 500

Stand-alone enclosures E Covers RAL



Installation depth [mm]	125/150	125/150/200	125/150/200	200
	Ci23E-125-RAL7032 090152	Ci43E-125-RAL7032 090154	Ci44E-125-RAL7032 090157	Ci45E-200-RAL7032 090160
	Ci23E-150-RAL7032 090153	Ci43E-150-RAL7032 090155	Ci44E-150-RAL7032 090158	
		Ci43E-200-RAL7032 090156	Ci44E-200-RAL7032 090159	

Size	Ci23	Ci43	Ci44	Ci45
Dimensions [mm]	187,5 x 250	375 x 250	375 x 375	375 x 500













Stand-alone enclosures X













Installation depth [mm]	125/150	125/150/200	125/150/200/250	200
	Ci23X-125 010408	Ci43X-125 019900	Ci44X-125 031765	Ci45X-200 098469
	Ci23X-150 015154	Ci43X-150 024646	Ci44X-150 034138	
		Ci43X-200 029392	Ci44X-200 036511	
			Ci44X-250 038884	

Ci Insulated Enclosures

Base parts

Size	Ci23	Ci43	Ci44	Ci45	Ci48
Dimensions [mm]	187,5 x 250	375 x 250	375 x 375	375 x 500	375 x 750
Base parts					
					
					
Depth [mm]	120	120	120	120	120
	U-Ci23 060282	U-Ci43 065028	U-Ci44 067269	U-Ci45 001894	U-Ci48 083880
	U-Ci23E 038793	U-Ci43E 064896	U-Ci44E 069642	U-Ci45E 001893	
	U-Ci23X 057909	U-Ci43X 062655	U-Ci44X 067401	U-Ci45X 098470	

Covers

Size	Ci23	Ci43	Ci44	Ci45	Ci48
Dimensions [mm]	187,5 x 250	375 x 250	375 x 375	375 x 500	375 x 750
Covers Transparent and RAL					
					
for installation depths [mm]	125/150	125/150/200	125/150/200/250	200	200/250
	D125-Ci23 014830	D125-Ci43 017203	D125-Ci44 019576	D200-Ci45 001895	D200-Ci48 078901
	D150-Ci23 024322	D150-Ci43 038560	D150-Ci44 040933	D200-Ci45- RAL7032 098476	D250-Ci48 083647
	D125-Ci23- RAL7032 098471	D200-Ci43 074155	D200-Ci44 076528		D200-Ci48- RAL7032 098477
	D150-Ci23- RAL7032 098472	D125-Ci43- RAL7032 002843	D250-Ci44 081274		D250-Ci48- RAL7032 098478
		D150-Ci43- RAL7032 098473	D125-Ci44- RAL7032 007589		
		D200-Ci43- RAL7032 005216	D150-Ci44- RAL7032 098474		
			D200-Ci44- RAL7032 009962		
			D250-Ci44- RAL7032 098475		

Ci Insulated Enclosures

Mounting plates

for size	Ci23	Ci43	Ci44	Ci45	Ci48
Mounting plates					
Material thickness [mm]	3 bzw. 4	3 bzw. 4	3 bzw. 4	3 bzw. 4	3 bzw. 4
	M3-Ci23 019709	M3-Ci43 029201	M3-Ci44 031574	M3-Ci45 003036	M3-Ci48 036320
	IM4-Ci23 086081	IM4-Ci43 088454	IM4-Ci44 090827		IM4-Ci48 093200

Accessory carrier rails

for enclosure dimension [mm]	1875	250	375	Abstandhalter	
DIN carrier rails					
Height [mm]	7,5 bzw. 15	7,5 bzw. 15	7,5 bzw. 15	25 bzw. 50	10 bzw. 15
	CL2 029064	CL3 033810	CL4 038556	HS25-CI 002291	ADT200-190 002289
	CL2-15 031437	CL3-15 036183	CL4-15 040929	HS50-CI 002292	ADT125-110 002290

Flange plates

for enclosure dimension [mm]	1875	250	375	125
Flange plates				
	FL2-X 086052	FL3-X 093171	FL4-X 024355	FL1-X 078933
	FL2-2 017898	FL3-1 088425	FL4-2 014863	
	FL2-3 020271	FL3-2 090798	FL4-3 017236	
		FL3-3 022644	FL4-4 019609	
			FL4-5 021982	

Accessories for external add-on

Spacers	Hinges for covers	Profiles for wall-fixing	Bracket for wall-fixing
ZRF3 067734	DSCH-Ci 034224	W16/32 090146	BL-Ci 036168
ZRF4 070107			BL-Ci-VA 038541

Ci Insulated Enclosures

Dimensions

Dimensions (mm)

Enclosures CI23...

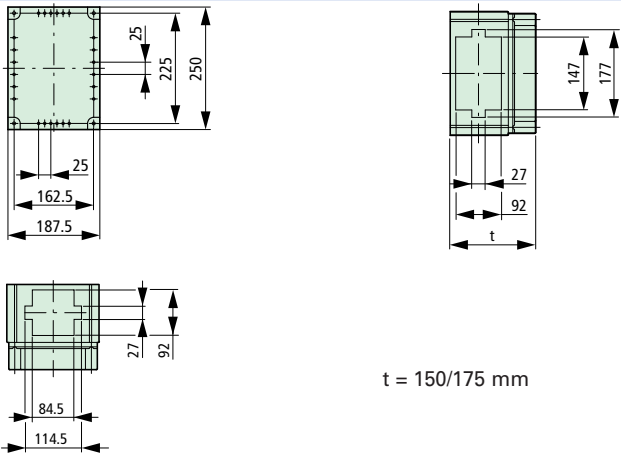

Enclosures CI43...

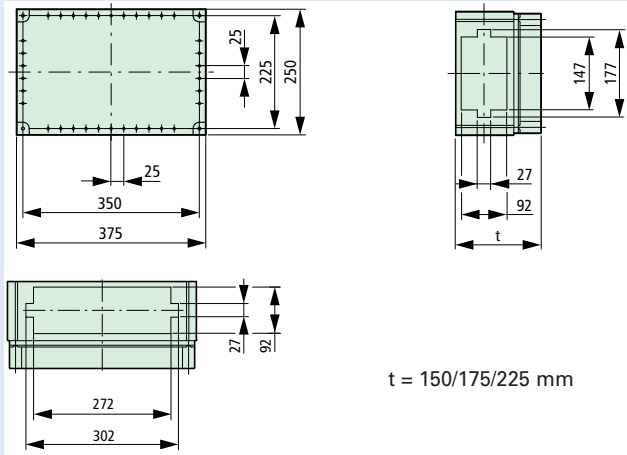

Enclosures CI44...

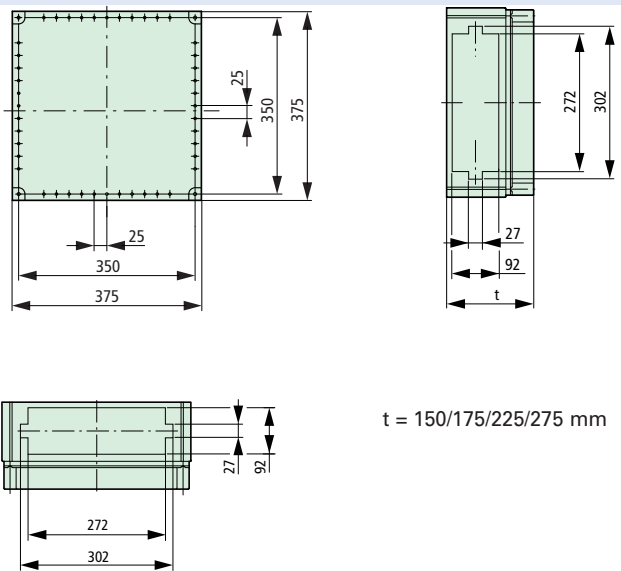

Enclosures CI45...

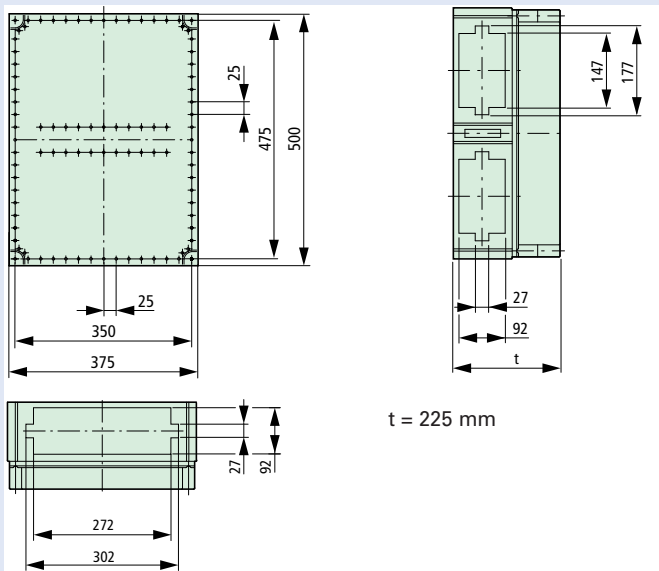

Enclosures CI48...

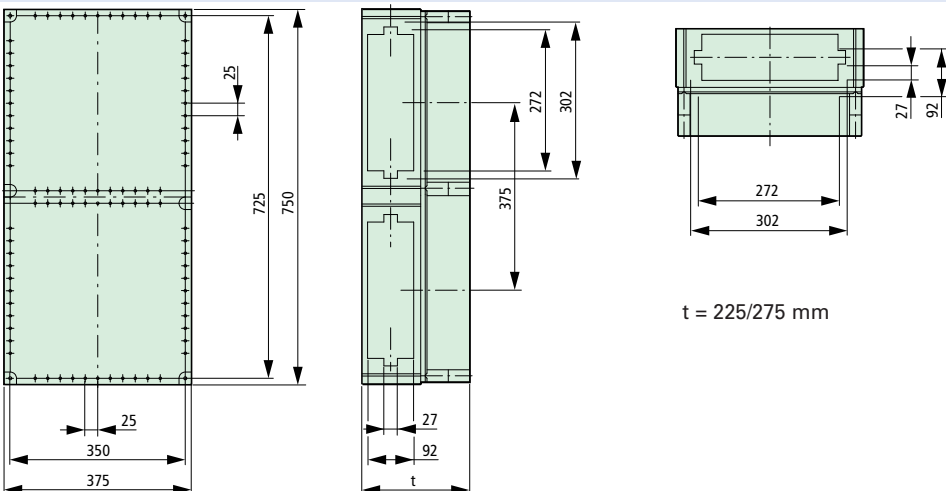

Photovoltaic - Switch-disconnectors up to 1500 V

Switch-disconnectors for 1000/1500 V DC, 1 and 2 pole

- IEC/EN 60947-3
- CCC China Compulsory Certificate
- Main switch characteristics including positive drive to IEC/EN 60204 and VDE 0113
- Isolating characteristics to IEC/EN 60947 and VDE 0660
- Busbar tag shroud to VDE0160 Part100
- Switch-disconnectors N can, in addition, be combined with voltage releases NZM...-XU, NZM...-XA and auxiliary contacts as well as with remote operator NZM...-XR...
- For DC switching you will need the series connection of all 4 current paths.
See picture of accessories for jumper kits
- Standard equipment: Screw-type connection, frame terminal available as an option
- In ungrounded networks (e.g. IT) the installation has to be done in a way to keep the likelihood of a double-ground fault neglectably low.
- Switches can not be combined with withdrawable units and/or connection on rear
- For N4-4 -...- S15-DC, feed only from below in connection with NZM4-4-XKV(I)2P(-K).



Rated operational current rated = uninterrupted current $I_n = I_u$ A	Short-circuit protective device fuse gR-characteristic A	Screw connection	1000VDC Fixed mounted Designation Article No.	1500VDC Fixed mounted Designation Article No.	Units per package
160	200	S	N2-4-160-S1-DC 127732	N2-4-160-S15-DC 167688	1 pcs.
200	200	S	N2-4-200-S1-DC 127733	N2-4-200-S15-DC 167689	1 pcs.
250	200	S	N2-4-250-S1-DC 154940	N2-4-250-S15-DC 167690	1 pcs.
320	500	S	N3-4-320-S1-DC 127734	N3-4-320-S15-DC 166407	1 pcs.
400	500	S	N3-4-400-S1-DC 142267	N3-4-400-S15-DC 166408	1 pcs.
500	500	S	N3-4-500-S1-DC 142268	N3-4-500-S15-DC 166409	1 pcs.
550	500	S	N3-4-550-S1-DC 168567	N3-4-550-S15-DC 168568	1 pcs.
800	-	S	N4-4-800-S1-DC 119890	N4-4-800-S15-DC 166413	1 pcs.
1000	-	S	N4-4-1000-S1-DC 119891	N4-4-1000-S15-DC 166414	1 pcs.
1250	-	S	N4-4-1250-S1-DC 119886	N4-4-1250-S15-DC 166415	1 pcs.
1400	-	S	N4-4-1400-S1-DC 119887	N4-4-1400-S15-DC 166416	1 pcs.
1600	-	S	N4-4-1600-S1-DC 152552	N4-4-1600-S15-DC 166417	1 pcs.

Photovoltaic - Switch-disconnectors up to 1500 V

Moulded Case Switches for 1000/1500 V DC, 1 and 2 pole

- IEC/EN 60947-3
- UL489B
- CCC China Compulsory Certificate
- Main switch characteristics including positive drive to IEC/EN 60204 and VDE 0113
- Isolating characteristics to IEC/EN 60947 and VDE 0660
- Busbar tag shroud to VDE0160 Part100
- Switch-disconnectors N can, in addition, be combined with voltage releases NZM...-XU, NZM...-XA and auxiliary contacts as well as with remote operator NZM...-XR...
- For DC switching you will need the series connection of all 4 current paths.
See picture of accessories for jumper kits
- Standard equipment: Screw-type connection, frame terminal available as an option
- In ungrounded networks (e.g. IT) the installation has to be done in a way to keep the likelihood of a double-ground fault neglectably low.
- Switches can not be combined with withdrawable units and/or connection on rear
- Where switchgear according to the UL489B standard is used, combining with plug-type or withdrawable technology, rear connection, connection enlargement, module plates and/or strap terminals is not possible.
- For IEC application: For N4-4 -...- S15-PV-NA, feed only from below in connection with NZM4-4-XKV(I)2P(-K).
- 100% continuous rated
- Molded case switch without self-protection



Rated operational current rated = uninterrupted current $I_n = I_u$ A	Short-circuit protective device fuse gR-characteristic A	Screw connection	1000VDC Fixed mounted Designation Article No.	1500VDC Fixed mounted Designation Article No.	Units per package
800	-	S	N4-4-800-S1-PV-NA 179325	N4-4-800-S15-PV-NA 179328	1 Stk.
1000	-	S	N4-4-1000-S1-PV-NA 179326	N4-4-1000-S15-PV-NA 179329	1 Stk.
1100	-	S	N4-4-1100-S1-PV-NA 179591	N4-4-1100-S15-PV-NA 179592	1 Stk.
1200	-	S	N4-4-1200-S1-PV-NA 179327	N4-4-1200-S15-PV-NA 179330	1 Stk.

Photovoltaic - Switch-disconnectors up to 1500 V

Bridge kits NZM...-XKV...2P..

2-pole
(+ and -)
on one side

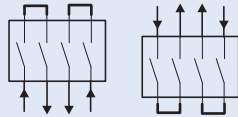

- Model contains parts for upper or lower row of switchgear side for 4 pole switches N4-4...-S1(S15)... that are used as 2 pole switches for DC
- The links each connect two contacts in series
- Incoming unit and outgoer at bottom according to the switching diagrams
- N4-4-... $\geq 1250\text{A}$ at 65°C alternate connection at bottom through module plates NZM4-4-XKM2S-1600
- For IEC application: For N4-4 -...- S15-PV-NA, feed only from below in connection with NZM4-4-XKV(I)2P(-K).

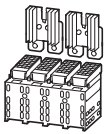

Rated operational current I_n A	Protection class	For use with	Notes	Designation Article No.	Units per package
Incl. cover					
225A at 40°C 170A at 65°C	IP2X	N2-4...S1(S15)-DC		NZM2-4-XKV2P 131730	1 pcs.
250A at 40°C 190A at 65°C	IP2X	N2-4...S1(S15)-DC	Incl. cooling unit	NZM2-4-XKV2P-K 168585	1 pcs.
517A at 40°C 435A at 65°C	IP2X	N3-4...S1(S15)-DC		NZM3-4-XKV2P 131731	1 pcs.
550A at 40°C 468A at 65°C	IP2X	N3-4...S1(S15)-DC	Incl. cooling unit	NZM3-4-XKV2P-K 142271	1 pcs.
1400A at 40°C 1260A at 65°C	IP2X	N4-4...S1(S15)-DC N4-4...S1(S15)-PV-NA		NZM4-4-XKV2P 119888	1 pcs.
Incl. insulation plates and phase separator					
238A at 40°C 180A at 65°C	IP00	N2-4...S1(S15)-DC		NZM2-4-XKV12P 168586	1 pcs.
250A at 40°C 213A at 65°C	IP00	N2-4...S1(S15)-DC	Incl. cooling unit	NZM2-4-XKV12P-K 168587	1 pcs.
534A at 40°C 451A at 65°C	IP00	N3-4...S1(S15)-DC		NZM3-4-XKV12P 142269	1 pcs.
550A at 40°C 501A at 65°C	IP00	N3-4...S1(S15)-DC	Incl. cooling unit	NZM3-4-XKV12P-K 142270	1 pcs.
1400A bei 40°C 1260A bei 65°C	IP00	N4-4-800(1000)(1250)(1400)-S1(S15)-DC N4-4...S1(S15)-PV-NA		NZM4-4-XKV12P 180020	1 pcs.
1600A at 40°C 1500A at 65°C	IP00	N4-4...S1(S15)-DC N4-4...S1(S15)-PV-NA	Incl. cooling unit	NZM4-4-XKV2P-K 152553	1 pcs.

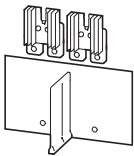

Detailed assignment taking into account ambient temperature, degree of protection and fitting position as listed in the attachment

Photovoltaic - Switch-disconnectors up to 1500 V

Bridge kits NZM...-XKV...2POU...

2-pole
(+ and -)
Double-sided

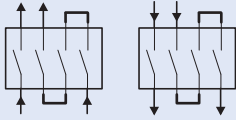

- Model contains parts for upper and lower row of switchgear side for 4 pole switches N...-S1(S15)-DC that are used as 2 pole switches for DC
- The links each connect three contacts in series
- Incoming unit and outgoer at bottom or top, according to the switching diagrams

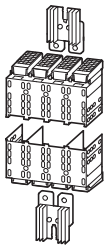

Rated operational current I_n A	Protection class	For use with	Notes	Designation Article No.	Units per package
Incl. cover					
200A at 40°C 160A at 65°C	IP2X	N2-4...S1(S15)-DC		NZM2-4-XKV2POU 144070	1 pcs.
225A at 40°C 170A at 65°C	IP2X	N2-4...S1(S15)-DC	Incl. cooling unit	NZM2-4-XKV2POU-K 168588	1 pcs.
400A at 40°C 388A at 65°C	IP2X	N3-4...S1(S15)-DC		NZM3-4-XKV2POU 168589	1 pcs.
517A at 40°C 435A at 65°C	IP2X	N3-4...S1(S15)-DC	Incl. cooling unit	NZM3-4-XKV2POU-K 168590	1 pcs.
Incl. insulation plates and phase separator					
213A at 40°C 160A at 65°C	IP00	N2-4...S1(S15)-DC		NZM2-4-XKVI2POU 170118	1 pcs.
238A at 40°C 180A at 65°C	IP00	N2-4...S1(S15)-DC	Incl. cooling unit	NZM2-4-XKVI2POU-K 170119	1 pcs.
501A at 40°C 418A at 65°C	IP00	N3-4...S1(S15)-DC		NZM3-4-XKVI2POU 170120	1 pcs.
534A at 40°C 451A at 65°C	IP00	N3-4...S1(S15)-DC	Incl. cooling unit	NZM3-4-XKVI2POU-K 170121	1 pcs.

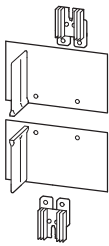

Detailed assignment taking into account ambient temperature, degree of protection and fitting position as listed in the attachment

Photovoltaic - Switch-disconnectors up to 1500 V

Bridge kits NZM...-XKV...1P..

1-pole
(+ or -)
on one side

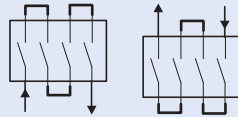

- Model contains parts for upper and lower row of switchgear side for 4 pole switches N4-4...-S1(S15)... that are used as 1 pole switches for DC
- The links each connect four contact in series (plus or minus)
- Incoming unit and outgoer at bottom or top, according to the switching diagrams

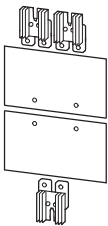
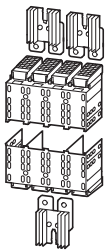

Rated operational current I_n A	Protection class	For use with	Notes	Designation Article No.	Units per package
Incl. cover					
200A at 40°C 160A at 65°C	IP2X	N2-4-160(200)-S1(S15)-DC		NZM2-4-XKV1P 168591	1 pcs.
225A at 40°C 170A at 65°C	IP2X	N2-4...-S1(S15)-DC	Incl. cooling unit	NZM2-4-XKV1P-K 168592	1 pcs.
400A at 40°C 388A at 65°C	IP2X	N3-4-320(400)-S1(S15)-DC		NZM3-4-XKV1P 168593	1 pcs.
517A at 40°C 435A at 65°C	IP2X	N3-4-400(500)-S1(S15)-DC	Incl. cooling unit	NZM3-4-XKV1P-K 168594	1 pcs.
1274A at 40°C 1138A at 65°C	IP2X	N4-4...-S1(S15)-DC N4-4-800(1000)(1100)-S1(S15)-PV-NA		NZM4-4-XKV1P 119889	1 pcs.
Incl. insulation plates					
213A at 40°C 160A at 65°C	IP00	N2-4...-S1(S15)-DC		NZM2-4-XKV1P 168595	1 pcs.
238A at 40°C 180A at 65°C	IP00	N2-4-200(250)-S1(S15)-DC	Incl. cooling unit	NZM2-4-XKV1P-K 168596	1 pcs.
501A at 40°C 418A at 65°C	IP00	N3-4...-S1(S15)-DC		NZM3-4-XKV1P 168597	1 pcs.
534A at 40°C 451A at 65°C	IP00	N3-4...-S1(S15)-DC	Incl. cooling unit	NZM3-4-XKV1P-K 168598	1 pcs.
1260A at 40°C 1138A at 65°C	IP00	N4-4-800(1000)(1250)(1400)-S1(S15)-DC N4-4...-S1(S15)-PV-NA		NZM4-4-XKV1P 180019	1 Stk.
1552A at 40°C 1448A at 65°C	IP00	N4-4...-S1(S15)-DC N4-4...-S1(S15)-PV-NA	mit Kühlkörper	NZM4-4-XKV1P-K 179331	1 Stk.

Detailed assignment taking into account ambient temperature, degree of protection and fitting position as listed in the attachment

Photovoltaic - Switch-disconnectors up to 1500 V

Temperature impact, derating

Reduction of the rated operating current (derating) at different ambient temperatures, fitting positions, degrees of protection and jumper kits IEC EN 60947

Rated operating current (A)

Load disconnecter switch	Touch protection	Jumper kit	Fitting position Load disconnecter switch	20°C	30°C	35°C	40°C	45°C	50°C	55°C	60°C	65°C	70°C	
N2-4-160-S1(15)-DC	IP2X	NZM2-4-XKV2P NZM2-4-XKV2POU-K NZM2-4-XKV1P-K	v	160	160	160	160	160	160	160	160	160	160	
	IP00	NZM2-4-XKV2P NZM2-4-XKV2POU-K NZM2-4-XKV1P-K	h	160	160	160	160	160	160	160	160	160	160	
	IP2X	NZM2-4-XKV1P-K NZM2-4-XKV2P	v	160	160	160	160	160	160	160	160	160	152	
			v	160	160	160	160	160	160	160	160	152	144	
	N2-4-200-S1(15)DC	IP00	NZM2-4-XKV2P-K	v	200	200	200	200	200	200	200	200	200	200
h				200	200	200	200	200	200	200	200	200	190	
IP2X		NZM2-4-XKV2P-K	v	200	200	200	200	200	200	200	200	190	180	
IP00		NZM2-4-XKV2P NZM2-4-XKV2POU-K NZM2-4-XKV1P-K	h	200	200	200	200	200	200	200	200	190	180	170
			IP2X	NZM2-4-XKV2P NZM2-4-XKV2POU-K NZM2-4-XKV1P-K	v	200	200	200	200	200	200	190	180	170
IP00		NZM2-4-XKV2POU NZM2-4-XKV1P	h	200	200	200	200	200	200	190	180	170	160	
			IP2X	NZM2-4-XKV2POU NZM2-4-XKV1P	v	200	200	200	200	190	180	170	160	
		h	200	200	200	190	180	170	160					
N2-4-250-S1(15)-DC	IP00	NZM2-4-XKV2P-K	v	250	250	250	250	250	250	238	225	213	200	
			h	250	250	250	250	250	238	225	213	200		
	IP2X	NZM2-4-XKV2P-K	h	250	250	250	250	238	225	213	200			
	IP00	NZM2-4-XKV2P NZM2-4-XKV2POU-K NZM2-4-XKV1P-K	h	250	250	250	238	225	213	200				
			IP2X	NZM2-4-XKV2P NZM2-4-XKV2POU-K NZM2-4-XKV1P-K	v	250	250	238	225	213	200			
	IP00	NZM2-4-XKV2POU NZM2-4-XKV1P	h	250	238	225	213	200						

v = vertical
h = horizontal

Photovoltaic - Switch-disconnectors up to 1500 V

Temperature impact, derating

Reduction of the rated operating current (derating) at different ambient temperatures, fitting positions, degrees of protection and jumper kits IEC EN 60947

Rated operating current (A)

Load disconnecter switch	Touch protection	Jumper kit	Fitting position Load disconnecter switch	20°C	30°C	35°C	40°C	45°C	50°C	55°C	60°C	65°C	70°C	
N3-4-320-S1(15)-DC	IP2X	NZM3-4-XKV2P NZM3-4-XKV2POU NZM3-4-XKV1P	v	320	320	320	320	320	320	320	320	320	320	
	IP00	NZM3-4-XKVI2P NZM3-4-XKV2POU NZM3-4-XKV1P	h	320	320	320	320	320	320	320	320	320	320	
N3-4-400-S1(15)-DC	IP2X	NZM3-4-XKV2P NZM3-4-XKV2POU-K NZM3-4-XKV1P-K	v	400	400	400	400	400	400	400	400	400	400	
	IP00	NZM3-4-XKVI2P NZM3-4-XKV2POU NZM3-4-XKV1P	h	400	400	400	400	400	400	400	400	400	388	
	IPX2	NZM3-4-XKV2POU	v	400	400	400	400	400	400	400	400	400	388	
		NZM3-4-XKV1P	h	400	400	400	400	400	400	400	400	388	376	
N3-4-500-S1(15)-DC	IP00	NZM3-4-XKVI2P-K	v	500	500	500	500	500	500	485	470	455	440	
			h	500	500	500	500	500	485	470	455	440	425	
	IP2X	NZM3-4-XKV2P-K	v	500	500	500	500	485	470	455	440	425	410	
	IP00	NZM3-4-XKVI2P NZM3-4-XKV2POU-K NZM3-4-XKV1P-K	h	500	500	500	485	470	455	440	425	410	400	
	IP2X	NZM3-4-XKV2P NZM3-4-XKV2POU-K NZM3-4-XKV1P-K	v	500	500	485	470	455	440	425	410	400		
	IP00	NZM3-4-XKVI2POU NZM3-4-XKV1P	h	500	485	470	455	440	425	410	400			
N3-4-550-S1(15)-DC	IP00	NZM3-4-XKVI2P-K	v	550	550	550	550	550	550	534	517	501	484	
			h	550	550	550	550	550	534	517	501	484	468	
	IP2X	NZM3-4-XKV2P-K	v	550	550	550	550	534	517	501	484	468	451	
	IP00	NZM3-4-XKVI2P NZM3-4-XKV2POU-K NZM3-4-XKV1P-K	h	550	550	550	534	517	501	484	468	451	435	
	IP2X	NZM3-4-XKV2P NZM3-4-XKV2POU-K NZM3-4-XKV1P-K	v	550	550	534	517	501	484	468	451	435	418	
	IP00	NZM3-4-XKVI2POU NZM3-4-XKV1P	h	550	534	517	501	484	468	451	435	418	402	
N4-4-800-S1(15)-...	IP2X (IP00)	+ NZM4-4-XKV2P + NZM4-4-XKV1P	v	800	800	800	800	800	800	800	800	800	800	
h		800	800	800	800	800	800	800	800	800	800	800		
N4-4-1000-S1(15)-...	IP2X (IP00)	(+ NZM4-4-XKV2P-K) (+ NZM4-4-XKV1P-K)	v	1000	1000	1000	1000	1000	1000	1000	1000	1000	1000	
h		1000	1000	1000	1000	1000	1000	1000	1000	1000	1000	1000		
N4-4-1100-S1(15)-PV-NA (for IEC-derating)	IP2X (IP00)	(+ NZM4-4-XKV1P) (+ NZM4-4-XKV2P)	v	1100	1100	1100	1100	1100	1100	1100	1100	1100	1100	
h		1100	1100	1100	1100	1100	1100	1100	1100	1100	1100	1100		
N4-4-1250(1200)-S1(15)-...	IP2X (IP00)	+ NZM4-4-XKV2P (+ NZM4-4-XKV1P)	v	1250	1250	1250	1250	1250	1250	1250	1250	1250	1250	
			h	1250	1250	1250	1250	1250	1250	1250	1250	1250	1250	
		+ NZM4-4-XKV1P (+ NZM4-4-XKV1P)	v	1250	1250	1250	1250	1250	1250	1250	1250	1250	1250	1213
			h	1250	1250	1250	1250	1250	1250	1250	1250	1250	1213	1188
			v	1250	1250	1250	1250	1250	1213	1188	1163	1138	1113	
			h	1250	1250	1250	1250	1213	1188	1163	1138	1113	1088	
N4-4-1400-S1(15)-DC	IP00	+ NZM4-4-XKV2P-K + NZM4-4-XKV1P-K	v	1400	1400	1400	1400	1400	1400	1400	1400	1400	1400	
			h	1400	1400	1400	1400	1400	1400	1400	1400	1400	1400	
IP2X (IP00)	+ NZM4-4-XKV2P (+ NZM4-4-XKV1P)	v	1400	1400	1400	1400	1358	1330	1302	1274	1260	-	-	
		h	1400	1400	1400	1358	1330	1302	1274	1260	-	-		
		v	1400	1330	1302	1274	1260	-	-	-	-	-	-	
		h	1358	1302	1274	1260	-	-	-	-	-	-	-	
N4-4-1600-S1(15)-DC	IP00	+ NZM4-4-XKV2P-K	v	1600	1600	1600	1600	1576	1552	1528	1512	1500	1472	
			h	1600	1600	1600	1576	1552	1528	1512	1500	1472	1448	
		+ NZM4-4-XKV1P-K	v	1600	1600	1576	1552	1528	1512	1500	1472	1448	1420	
			h	1600	1576	1552	1528	1512	1500	1472	1448	1420	-	

v = vertical
h = horizontal

Photovoltaic - Switch-disconnectors up to 1500 V

Technical data

Switch-disconnectors 1000 VDC

			N2-4-...-S1-DC max. 250A	N3-4-...-S1-DC max. 550A	N4-4-...-S1-DC max. 1600A	N4-4-...-S1-PV-NA max. 1200A UL / 1250A IEC	
Norm/Approbation			IEC 60947-3 / CCC	IEC 60947-3 / CCC	IEC 60947-3 / CCC	UL489B / IEC 60947-3 / CCC	
Rated operational voltage	U _e	VDC	1000	1000	1000	1000	
Rated insulation voltage	U _i	VDC	1250	1250	1250	1250	
Rated impulse withstand voltage	U _{imp}						
Main contacts		V	8000	8000	8000	8000	
Auxiliary contacts	V		6000	6000	6000	6000	
Category of utilization			DC-22A	DC-22A	DC-22A	DC-22A	
Rated uninterrupted current with terminal jumpers							
at 40°C	I _u	A	250	550	1600	1200	
at 65°C	I _u	A	250	500	1500	1200	
Rated operating current	I _e	A	250	550	1600	1200	
Rated switch-on and switch-off capacity		A	1200	2200	6400	4800	
Rated short-time withstand current t = 1 s	I _{cw}	kA	3.6	6.6	34 (0,1s)	34 (0,1s)	
Rated conditional short-circuit current	I _q	kA	15	15	-	-	
With back-up fuse up to 1000 V		A gR/gPV	200	2x250	-	-	
Maximum operating frequency		S/h	120	60	60	60	
Lifespan							
mechanical		Operations	20000	15000	10000	10000	
(of which max. 50 %trip by N/U release)							
electrical		Operations	1000	1000	500	500	
Overvoltage category			III	III	III	III	
Degree of pollution			3	3	3	3	
Power loss at rated current	I _u	A	160 200 250	320 400 500 550	800 1000 1250 1600	800 1000 1100 1200	
Load disconnect switch		P	W	27 42 66	62 96 150 182	81 127 177 290	81 127 137 163
Jumper kit for each jumper fitted		P	W	1 1.5 2	4 6 9.5 11	0.6 1 1.6 2.6	0.6 1 1.3 1.5
Short Circuit Current Withstand (UL489B, Sequenz G at t = 50ms)	I	kA	-	-	-	35	

Notes:

N...S1-DC cannot be combined with plug-in or withdrawable units and/or in case of rear connection.

Switch-disconnectors 1500VDC

			N2-4-...-S15-DC max. 250A	N3-4-...-S15-DC max. 550A	N4-4-...-S15-DC max. 1600A	N4-4-...-S15-PV-NA max. 1200A UL / 1250A IEC	
Norm/Approbation			IEC 60947-3 / CCC	IEC 60947-3 / CCC	IEC 60947-3 / CCC	UL489B / IEC 60947-3 / CCC	
Rated operational voltage	U _e	VDC	1500	1500	1500	1500	
Rated insulation voltage	U _i	VDC	1500	1500	1500	1500	
Rated impulse withstand voltage	U _{imp}						
Main contacts		V	10000	10000	10000	10000	
Auxiliary contacts	V		6000	6000	6000	6000	
Category of utilization			DC-22A	DC-22A	DC-22A	DC-21A	
Rated uninterrupted current with terminal jumpers							
at 40°C	I _u	A	250	550	1600	1200	
at 65°C	I _u	A	250	500	1500	1200	
Rated operating current	I _e	A	250	550	1600	1200	
Rated switch-on and switch-off capacity		A	1200	2200	6400	4800	
Rated short-time withstand current t = 1 s	I _{cw}	kA	3.6	6.6	34 (0,1s)	34 (0,1s)	
Maximum operating frequency		S/h	120	60	60	60	
Lifespan							
mechanical		Operations	20000	15000	10000	10000	
(of which max. 50 %trip by N/U release)							
electrical		Operations	1000	1000	500	500	
Overvoltage category			III	III	III	III	
Degree of pollution			2	2	3	3	
Power loss at rated current	I _u	A	160 200 250	320 400 500 550	800 1000 1250 1600	800 1000 1100 1200	
Load disconnect switch		P	W	27 42 66	62 96 150 182	81 127 177 290	81 127 137 163
Jumper kit for each jumper fitted		P	W	1 1.5 2	4 6 9.5 11	0.6 1 1.6 2.6	0.6 1 1.3 1.5
Short Circuit Current Withstand (UL489B, Sequenz G at t = 50ms)	I	kA	-	-	-	35	

Notes:

N...S15-DC cannot be combined with plug-in or withdrawable units and/or in case of rear connection.

Photovoltaic - Switch-disconnectors up to 1500 V

Technical data

Fitting position

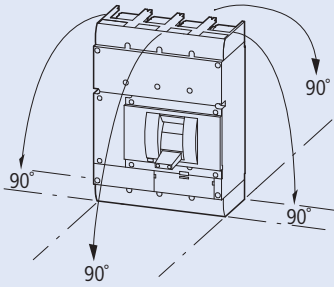

IT network including the possibility of a double-ground fault

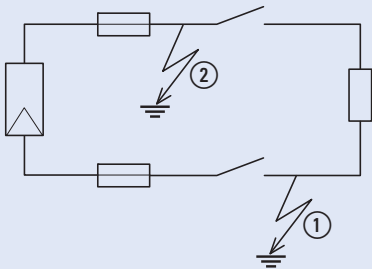

In ungrounded networks (e.g. IT) the installation has to be done in a way to keep the likelihood of a double-ground fault neglectably low.

Where a double-ground fault cannot be excluded - depending on the use of jumper kits and on the layout of the 1 or 2-pole circuit - the following maximum rated operating voltage levels have to be respected to make sure that - even in case of a double-ground fault - safe switch-on and switch-off is possible.

Rated operating voltage U_e max.:

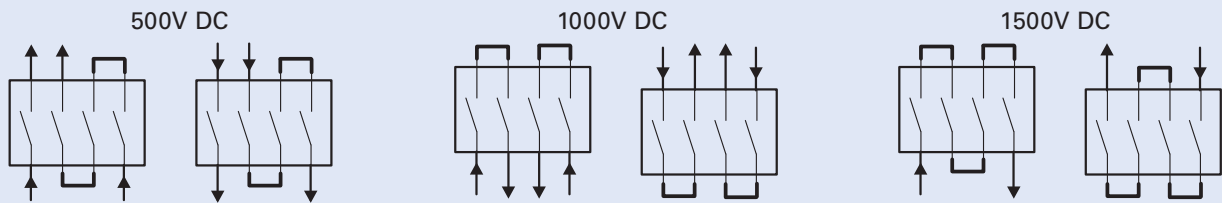

Photovoltaic - Switch-disconnectors up to 1500 V

Dimensions

Dimensions (mm)

Switch-disconnectors, 4 pole, N2-4...DC

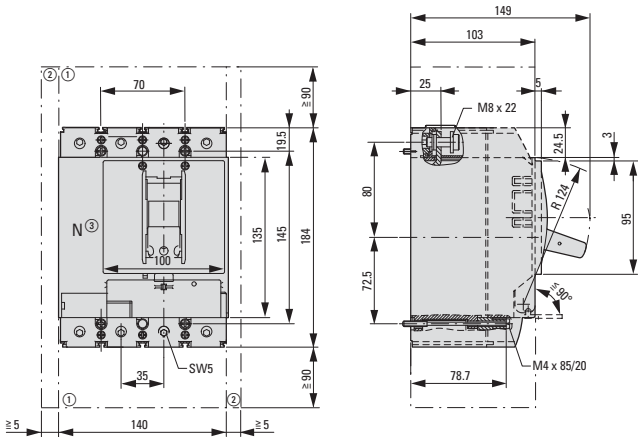

- ① Blow out area, minimum clearance to other parts
- ② Minimum clearance to adjacent parts

Jumper kit, NZM2-4-XKV...

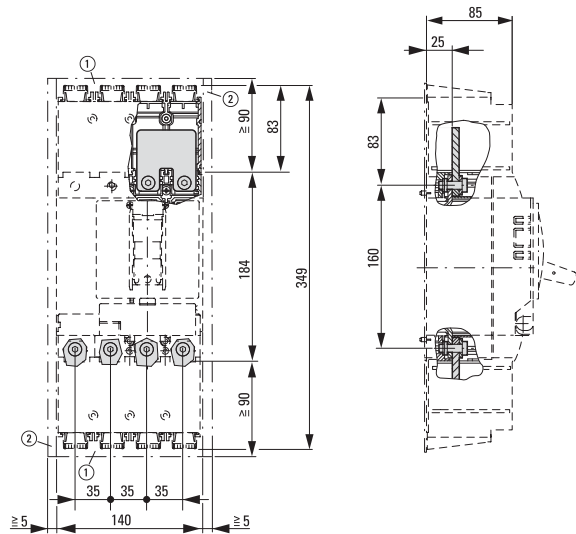

Jumper kit, NZM2-4-XKVI...

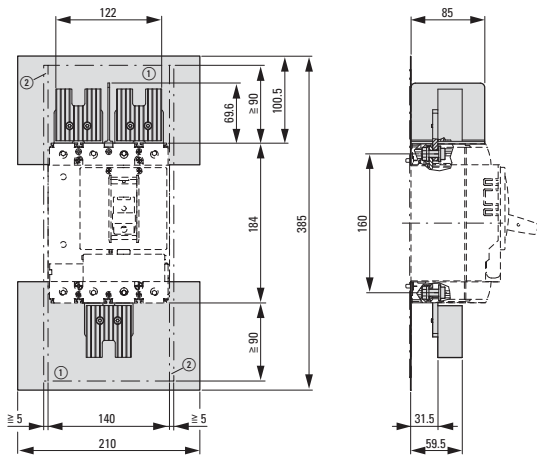

Switch-disconnectors, 4 pole, N3-4...DC

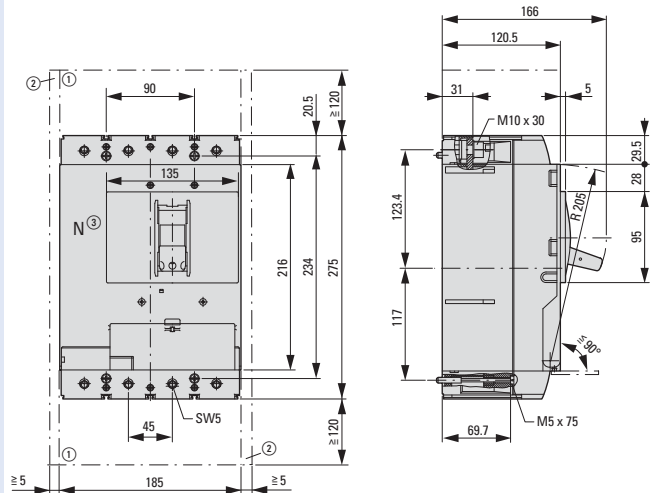

- ① Blow out area, minimum clearance to other parts
- ② Minimum clearance to adjacent parts

Jumper kit, NZM3-4-XKV...

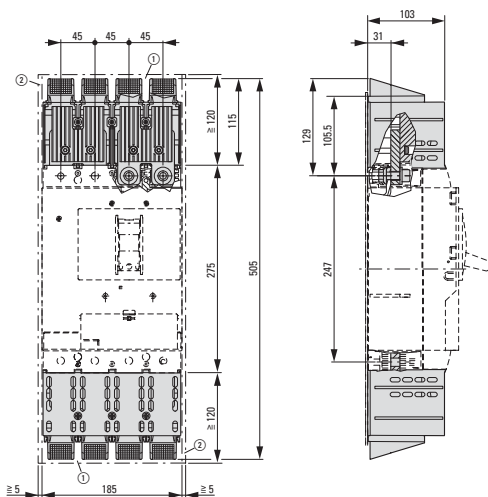

Jumper kit, NZM3-4-XKVI...

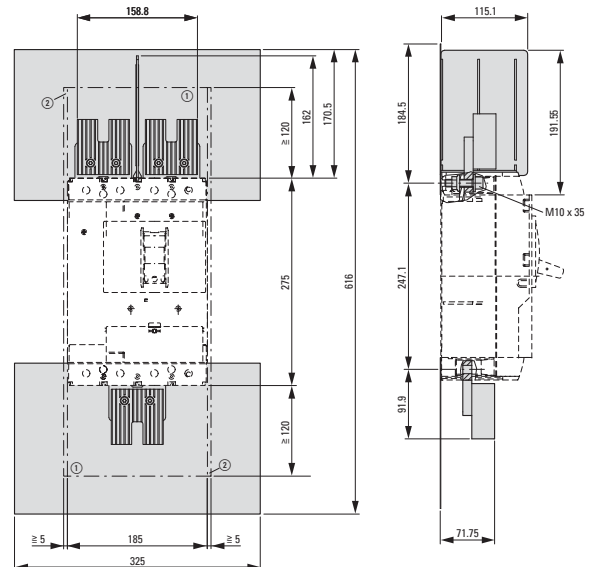

Photovoltaic - Switch-disconnectors up to 1500 V

Dimensions

Dimensions (mm)

Switch-disconnectors, 4-pole, N4-4...DC (PV-NA)

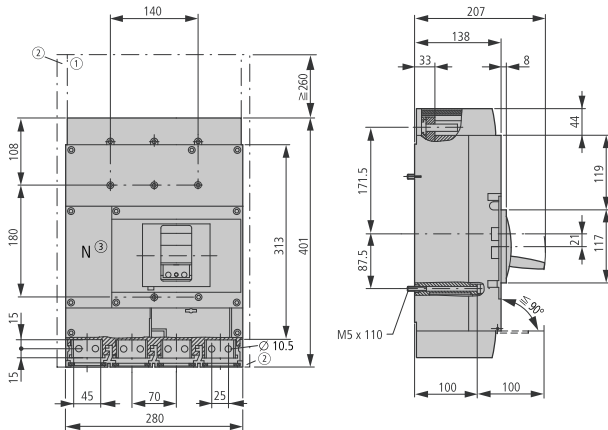

- ① Blow out area, minimum clearance to other parts
≤ 1500 V: H 260mm
- ② Minimum clearance to adjacent parts
≤ 1000 V: 15mm
≤ 1500 V: 70mm

Jumper kit, NZM4-4-XKV1(2)P

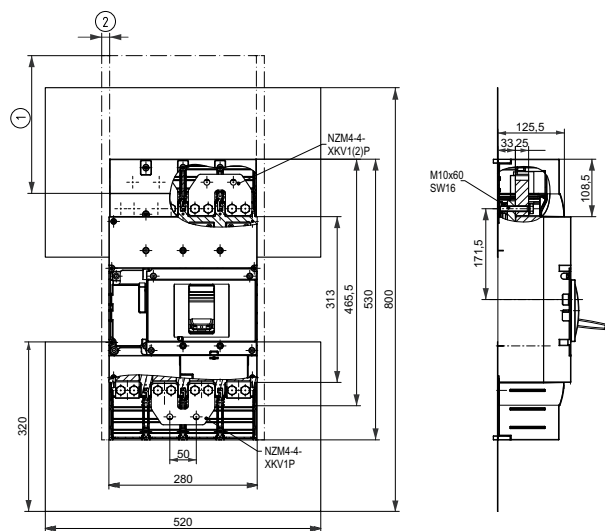

Jumper kit, NZM4-4-XKV1(2)P-K

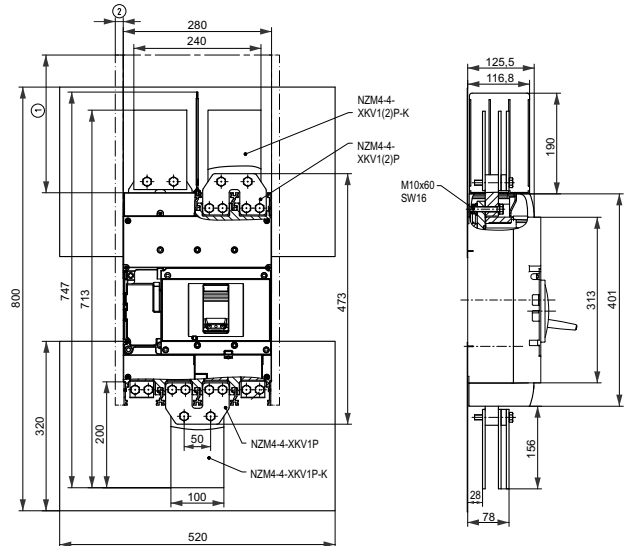

Contactors DILM

- IEC60947-4-1
- Contacts according to EN50012

Technical data

DILM12 DILM32 DILM65 DILM150 DILM225 DILM300 DILM500 DILH1400

General

Lifespan, mechanical

	Operations	x10 ⁶	10	10	10	10	10	10	7	5
AC operated	Operations	x10 ⁶	10	10	10	10	10	10	7	5
DC operated	Operations	x10 ⁶	10	10	10	10	10	10	7	5

Ambient temperature

	°C	-25 - 60	-25 - 60	-25 - 60	-25 - 60	-25 - 60	-25 - 60	-25 - 60	-25 - 60	-25 - 60
open	°C	-25 - 60	-25 - 60	-25 - 60	-25 - 60	-25 - 60	-25 - 60	-25 - 60	-25 - 60	-25 - 60
enclosed	°C	-25 - 40	-25 - 40	-25 - 40	-25 - 40	-25 - 40	-25 - 40	-25 - 40	-25 - 40	-25 - 40
storage	°C	-40 - 80	-40 - 80	-40 - 80	-40 - 80	-40 - 80	-40 - 80	-40 - 80	-40 - 80	-40 - 80

Magnet systems

Power consumption of the coil in a cold state and 1.0 x U_c

	Pick-up	VA	24	52	149	180	210	380	450	800
50HZ	Pick-up	VA	24	52	149	180	210	380	450	800
50Hz	Sealing	VA	3.4	7.1	16	3.1	2.6	4.3	4.3	7.5
DC operated	Pick-up	W	4.5	12	24	149	180	250	350	700
DC operated	Sealing	W	4.5	0.5	0.5	2.1	2.1	3.3	3.3	6.5

Controlling & Switching

Contactors DILM

Basic devices up to 170 A

0389_00178013_0



	Conventional thermal current $I_{th} = I_e$ open AC-1 at 60°C $I_{th}=I_e$ A	Can be combined with auxiliary contact	AC operation	DC operation
			Designation Article No.	Designation Article No.
20		DILM32-XHI... DILA-XHI(V)..	DILM12-10(230V50HZ) 276830	DILM12-10(24VDC) 276845
40		DILM32-XHI... DILA-XHI(V).. DILM32-XHI11-S	DILM32-10(230V50HZ) 277260	DILM32-10(RDC24) 277274
80		DILM150-XHI(V)... DILM1000-XHI(V)..	DILM65(230V50HZ) 277894	DILM65(RDC24) 277908
160		DILM150-XHI(V)... DILM1000-XHI(V)..	DILM150(RAC240) 239588	DILM150(RDC24) 239591

Contactors DILM, DILH

Comfort devices greater than 150 A

0389_00178013_0



	Conventional thermal current $I_{th} = I_e$ open AC-1 at 60°C $I_{th}=I_e$ A	Designation	Article No.
		Article No.	
315		DILM225A/22(RAC240)	139547
350		DILM300A/22(RA250)	139556
700		DILM500/22(RA250)	208213
1400		DILH1400/22(RAW250)	272441

Grid & systems protection

Technical data

Combined Grid & Systems Protection (IP 65 degree of protection)

Type designation		NAS63-CI-1	NAS80-CI-1	NAS125-CI-1-K95	NAS160-CI-1-K95
Article No.		168106	168107	168110	168111
Rated output	kVA	43	55	86	100
Rated operating voltage	V	230/400	230/400	230/400	230/400
Rated current AC-1	A	63	80	125	160

Power consumption for Pick-up

Monitoring relay	VA	5	5	5	5
2 contactors	VA	90	90	360	360

Power consumption while Holding

Monitoring relay	W	5	5	5	5
2 contactors	VA/W	3/3	3/3	6,2/4,2	6,2/4,2
Own consumption	kWh/a	70	70	98	98
Total breaking time (incl. protective grid & systems)	ms	< 150	< 150	< 150	< 150
Ambient temperature	°C	-20 ... + 40	-20 ... + 40	-20 ... + 40	-20 ... + 40
Making time	% ED		100	100	100

Max. cross section of connections

		Contactors		Terminals	
Fine-wired with wire end	mm ²	35 (Cu)		95 (Cu)	
Multi-wired	mm ²	50 (Cu)		95 (Cu)	
Sector conductor, single-wired	mm ²	-		70 (Al)	
Sector conductor, multi-wired	mm ²	-		95 (Cu)	

PE terminals

Fine-wired with wire end	mm ²	50 (Cu)		95 (Cu)	
Multi-wired	mm ²	50 (Cu)		95 (Cu)	
Sector conductor, single-wired	mm ²	-		70 (Al)	
Sector conductor, multi-wired	mm ²	-		95 (Cu)	

NA relay

		UFR1001E (made by ZIEHL) integrated		UFR1001E (made by ZIEHL) integrated	
--	--	-------------------------------------	--	-------------------------------------	--

Coupled switchgear

Style		4-pole contactors			
Type designation		DILMP63 (RAC240)	DILMP80 (RAC240)	DILMP125 (RAC240)	DILMP160 (RAC240)
Article No.		167512	167513	109905	109915
Making capacity	A	560	700	1120	1330
Breaking capacity	A	400	500	800	950
Short-circuit protection	A (gG)	125	160	250	250
Non-influenced short-circuit current	kA	100	100	100	100
Open time	ms	45	45	40	40

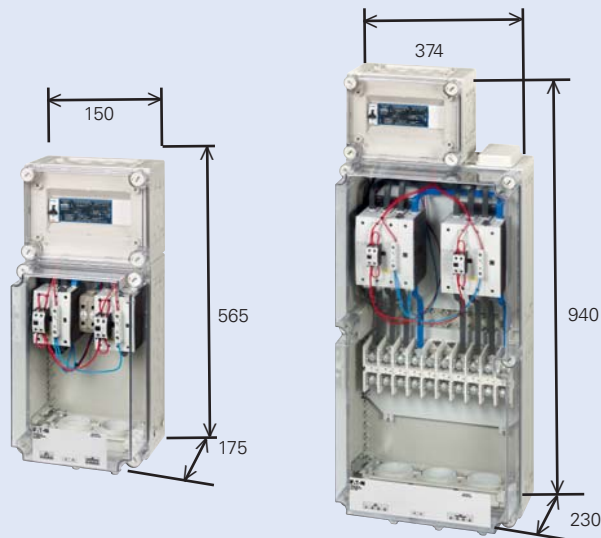

NA-protection switch - switch combinations

Recommended is a section switch according to application rule VDE-ARN-N-4105

Low-voltage grid ~ 400 V / 230 V

3-pole switching in a TN-C- and 4-pole switching in a TN-S-system

There are three different combinations possible:

- Circuit breaker – Circuit breaker
- Circuit breaker – Load disconnecter switch
- Load disconnecter switch – Load disconnecter switch

The combination Load disconnecter switch – Load disconnecter switch needs to be equipped with an up-stream short-circuit protection (fuse).

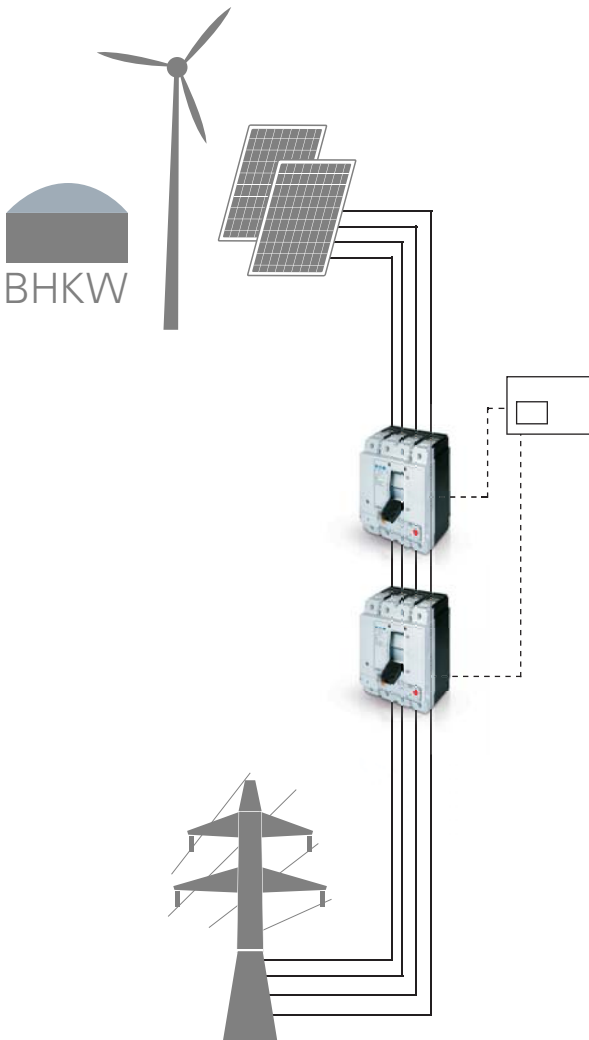

Apparent power kVA	Rated current A	N (%)	4 pole			3 pole		
			Circuit breaker (Icu = 50 kA)	Load disconnecter switch	Fuse A gL max	Circuit breaker (Icu = 50 kA)	Load disconnecter switch	Fuse A gL max
			4 pole Typ (Art.-Nr.)	4 pole Typ (Art.-Nr.)		3 pole Type (Art.-Nr.)	3 pole Type (Art.-Nr.)	
14	20	100	NZMH2-4-A20 281287	N2-4-160 266014	250	NZMH2-A20 281281	N2-160 266008	250
17	25	100	NZMH2-4-A25 281289	N2-4-160 266014	250	NZMH2-A25 281282	N2-160 266008	250
22	32	100	NZMH2-4-A32 281291	N2-4-160 266014	250	NZMH2-A32 281283	N2-160 266008	250
28	40	100	NZMH2-4-A40 265823	N2-4-160 266014	250	NZMH2-A40 259095	N2-160 266008	250
35	50	100	NZMH2-4-A50 265825	N2-4-160 266014	250	NZMH2-A50 259096	N2-160 266008	250
44	63	100	NZMH2-4-A63 265827	N2-4-160 266014	250	NZMH2-A63 259097	N2-160 266008	250
55	80	100	NZMH2-4-A80 265829	N2-4-160 266014	250	NZMH2-A80 259098	N2-160 266008	250
69	100	100	NZMH2-4-A100 265831	N2-4-160 266014	250	NZMH2-A100 259099	N2-160 266008	250
87	125	100	NZMN2-4-A125 265858	N2-4-160 266014	250	NZMN2-A125 259091	N2-160 266008	250
111	160	100	NZMN2-4-A160 265860	N2-4-160 266014	250	NZMN2-A160 259092	N2-160 266008	250
		60	NZMN2-4-A160/100 265861					
139	200	100	NZMN2-4-A200 265863	N2-4-200 266015	250	NZMN2-A200 259093	N2-200 266009	250
		60	NZMN2-4-A200/125 265864					
222	320	100	NZMN3-4-A320 109694	N3-4-400 266023	630	NZMN3-A320 109669	N3-400 266019	630
		60	NZMN3-4-A320/200 109695					
277	400	100	NZMN3-4-A400 109696	N3-4-400 266023	630	NZMN3-A400 109670	N3-400 266019	630
		60	NZMN3-4-A400/250 109697					
346	500	100	NZMN3-4-AE630 265894	N3-4-630 266024	630	NZMN3-AE630 259115	N3-630 266020	630
		60	NZMN3-4-AE630/400 265895					
554	800	100	NZMN4-4-AE800 265909	N4-4-800 266029	1600	NZMN4-AE800 265759	N4-800 266025	1600
		60	NZMN4-4-AE800/500 265910					
693	1000	100	NZMN4-4-AE1000 265912	N4-4-1000 266030	1600	NZMN4-AE1000 265760	N4-1000 266026	1600
		60	NZMN4-4-AE1000/630 265913					
866	1250	100	NZMN4-4-AE1250 265915	N4-4-1250 266031	1600	NZMN4-AE1250 265761	N4-1250 266027	1600
		60	NZMN4-4-AE1250/800 265916					

Notes

- Max. ambient temperature 50 °C
- < 100 kVA contactors alternatively admitted
- Accessories required for automatic switch-on and instant switch-off:
1 remote drive, undervoltage release and auxiliary switch each



Energy from sun



Helios, the power of the sun,

drove his four-horse chariot across the sky, from east to west, every day. With his enormous power, he granted warmth and light to ensure life on Earth.



Energy from wind



Aeolus, the power of the wind,

determined the fate of seamen. In a favorable mood, he sent a favorable wind. But when angered, he would blow ships in the wrong direction. Aeolus also played an important role in the journey of Odysseus.



Energy from water



Poseidon, the power of the sea,

known to seafarers in search of a peaceful journey by ship. In an agreeable mood, he left the sea calm. But when Poseidon grew angry, he would strike the water with his trident and use his power to sink ships.



Energy from Earth



Gaia the power of the Earth

and creator of all life. The force of elemental power deciding the destiny of all life on Earth. With her maternal warmth, Gaia both protected the Earth and personified the consciousness of the natural planet.

Eaton is a power management company with 2016 sales of 19.7 billion. Eaton provides energy-efficient solutions that help our customers effectively manage electrical, hydraulic and mechanical power more efficiently, safely and sustainably. Eaton has approximately 95,000 employees and sells products to customers in more than 175 countries.

Published by:
Eaton Industries (Austria) GmbH
Scheydgasse 42
A-1210 Wien

The products presented are part of the comprehensive Eaton offer. For more information, please contact your Eaton consultant.

www.eaton.eu

For more information, visit www.eaton.eu.

Eaton Industries Manufacturing GmbH
EMEA Headquarters
Route de la Longeraie
1110 Morges
Switzerland

© 2017 Eaton Industries (Austria) GmbH
Subject to technical modifications. No responsibility is taken for misprints or errata.
Printed in Austria (04/17)
Publication number BR1601001Z-EN

Graphic design: SRA, Schrems
Print: Rabl, Schrems

