

Instructions for Digitrip RMS 510 Trip Unit



Powering Business Worldwide

Contents

Description	Page
Important Safety Instructions	3
1 General Description - Digitrip RMS 510 Trip Unit	3
1.1 Basic Digitrip RMS 510 Trip Unit	3
1.1.1 Operational Status and Protection TRIP Indicators	4
1.1.2 General Over-Current Protection	5
1.1.3 Discriminator (High Initial Current Release) (For Types LS and LSG Trip Units Only)	7
1.1.4 OVERRIDE (Fixed Instantaneous)	7
1.1.5 Zone Interlocking	7
1.2 Frame Rating, Sensor Rating (where applicable) and Rating Plugs	8
1.3 Auxiliary Power Module	9
2 UL Listed Devices	9
3 Protection Settings	10
3.1 General	10
3.2 Long Delay Current Setting	10
3.3 Long Delay Time Setting	10
3.4 Short Delay Current Setting	10
3.5 Short Delay Time Setting	11
3.6 Instantaneous Current Setting	11
3.7 No Instantaneous Current Setting	11
3.8 Ground Fault Current Setting	11
3.9 Ground Fault Time Delay Setting	12
4 Test Procedures	12
4.1 General	12
4.2 When To Test	12
4.3 Testing Provisions	12
4.4 Conducting Tests	13
4.4.1 Control Power	13
4.4.2 Not Tripping the Breaker	13
4.4.3 Tripping the Breaker	14
4.5 Testing the Back-up Battery (Inside the Rating Plug)	14
4.5.1 Back-up Battery Check	14
4.5.2 Replacing the Back-up Battery	14
5 References	15
5.1 Digitrip RMS Trip Assemblies	15
5.2 Type DS Low-Voltage AC Power Circuit Breakers	15
5.3 Type DS II Low-Voltage AC Power Circuit Breakers	15
5.4 Type SPB Systems Pow-R	15
5.5 Series C® R-Frame Molded Case Circuit Breakers	15
APPENDIX A: Zone Interlocking	16

List of Figures

Description	Page
Figure 1. RMS Digitrip 510 Trip Unit - Block Diagram	3
Figure 2. Digitrip RMS 510 Trip Unit Type LSI with Rating Plug	4
Figure 3. Digitrip RMS 510 Type LI	5
Figure 4. Digitrip RMS 510 Type LS	5
Figure 5. Digitrip RMS 510 Type LSI	6
Figure 6. Digitrip RMS 510 Type LIG	6
Figure 7. Digitrip RMS 510 Type LSG	6
Figure 8. Digitrip RMS 510 Type LSI	6
Figure 9. Rating Plug	8
Figure 10. Auxiliary Power Module	9
Figure 11. Long Delay Current Settings	10
Figure 12. Long Delay Time Settings	10
Figure 13. Long Time Memory "LTM" Jumper	10
Figure 14. Short Delay Current Settings	10
Figure 15. Short Delay Time Settings	11
Figure 16. Instantaneous Current Settings	11
Figure 17. Ground Fault Current Settings	11
Figure 18. Ground Fault Time Delay Settings	12
Figure 19. Integral Test Panel (Lower Right Corner of Trip Unit)	13
Figure A.1 Typical Zone Interlocking (Ground Fault Protection)	16
Figure A.2 Typical Zone Interlocking Connections with Two Main Breakers (M1, M2) and a Tie Breaker (T) (Short Delay Protection)	16

List of Tables

Description	Page
Table 1. Ground Fault Current Settings	11

Important Safety Instructions

WARNING

DO NOT ATTEMPT TO INSTALL OR PERFORM MAINTENANCE ON EQUIPMENT WHILE IT IS ENERGIZED. DEATH OR SEVERE PERSONAL INJURY CAN RESULT FROM CONTACT WITH ENERGIZED EQUIPMENT. ALWAYS VERIFY THAT NO VOLTAGE IS PRESENT BEFORE PROCEEDING WITH THE TASK, AND ALWAYS FOLLOW GENERALLY ACCEPTED SAFETY PROCEDURES. EATON CORPORATION IS NOT LIABLE FOR THE MISAPPLICATION OR MISINSTALLATION OF ITS PRODUCTS.

It is strongly urged that the User observe all recommendations, warnings and cautions relating to the safety of personnel and equipment, as well as all general and local health and safety laws, codes, and procedures.

The recommendations and information contained herein are based on experience and judgment, but should not be considered to be all-inclusive or covering every application or circumstance which may arise. If you have any questions or need further information or instructions, please contact your local representative, or the Customer Support Center for the type of circuit breaker you have.

1 General Description - Digitrip RMS 510 Trip Unit

1.1 Basic Digitrip RMS 510 Trip Unit

The Digitrip RMS 510, illustrated in Figure 2, is a Trip Unit suitable for use in types DS and DSL Low-Voltage AC power circuit breakers and type SPB Systems Pow-R circuit breakers and Series C R-Frame molded case circuit breakers. The Digitrip RMS 510 Trip Unit provides three basic functions:

Function	Section
Protection	1.1.2 – 1.1.5 and 3
Information	1.1.1
Testing	4

Digitrip RMS 510 provides true RMS current sensing for proper correlation with thermal characteristics of conductors and equipment. Interchangeable rating plugs are provided to establish the continuous current rating of each circuit breaker. The Digitrip RMS 510 Trip Unit is designed for use in industrial circuit breaker environments where the ambient temperatures can range from -20°C to +85°C (-4°F to 185°F) and rarely exceed 70 to 75°C (158 to 167°F). If, however, temperatures in the neighborhood of the Trip Unit do exceed this range, the Trip Unit performance may be degraded. In order to insure that the tripping function is not compromised due to an over-temperature condition, the Digitrip RMS 510 microcomputer chip has a built-in over-temperature protection feature, factory set to trip the breaker if the chip temperature is excessive. If over-temperature is the reason for the trip, the Long Delay Time LED will light "RED".

The Trip Unit employs the Eaton custom designed integrated circuit microprocessor which includes a micro-computer to perform its numeric and logic functions. The principle of operation is described by the block diagram shown in Figure 1.

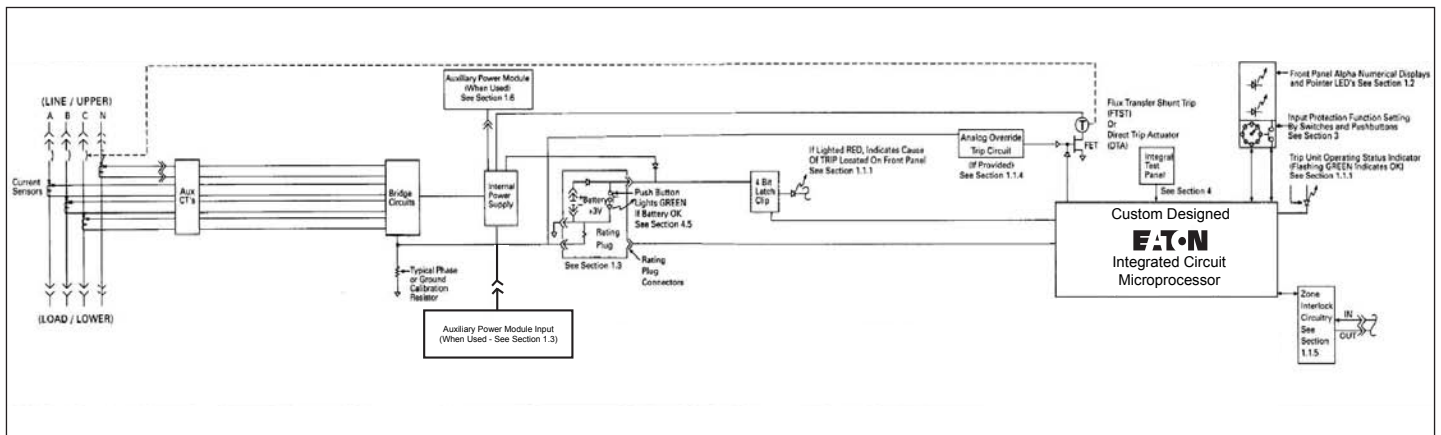

Figure 1. RMS Digitrip 510 Trip Unit - Block Diagram.

In the Digitrip RMS 510 Trip Unit, all required sensing and tripping power to operate its protection function is derived from the current sensors in the circuit breaker. The secondary currents from these sensors provide the correct input information for the protector functions, as well as tripping power, whenever the circuit breaker is carrying current. These signals develop analog voltages across the appropriate sensing resistors including:

1. Phase currents;
2. Ground current or Neutral current (when supplied); and
3. Rating plug.

The resulting analog voltages are digitized by the custom designed integrated circuits. The micro-computer, in cyclic fashion, repeatedly scans the voltage values across each sensing resistor and enters these values into its Random Access Memory (RAM). The data used to calculate true RMS current values, which are then repeatedly compared with the protection function settings and other operating data stored in the memory. The software program then determines whether to initiate protection functions, including tripping the breaker through the low energy trip device (Flux Transfer Shunt Trip or Direct Trip Actuator) in the circuit breaker.

1.1.1 Operational Status and Protection TRIP Indicators

The "Green" Light Emitting Diode (LED) in the lower right corner of the Trip Unit (Figure 2) "blinks" once each second to indicate the Trip Unit is operating normally. Once the load current through the circuit breaker exceeds approximately 10% of the frame/current sensor rating, the green LED will flash "On" and "Off" once each second, to indicate the trip unit is energized and operating properly.

Note: If the LED is steadily "GREEN", i.e. not blinking, the Trip Unit is not ready.

The LEDs, shown in Figures 2 and 3 thru 8 on the face of the Trip Unit, light "RED" to indicate the reason for any automatic trip operation. As indicated in Figures 3 thru 8, each LED is strategically located in the related segment of the time-current curve depicted on the face of the Trip Unit. The reason for trip is identified by the segment of the time-current curve where the LED is lit "RED". Following an automatic protection trip operation, the back-up battery continues to supply power to LED's as indicated in Figures 2 and 9. The Digitrip can be RESET by:

- Pressing and releasing the "TRIP RESET" button (See Figure 2 lower right corner just above the "UNIT STATUS" LED);

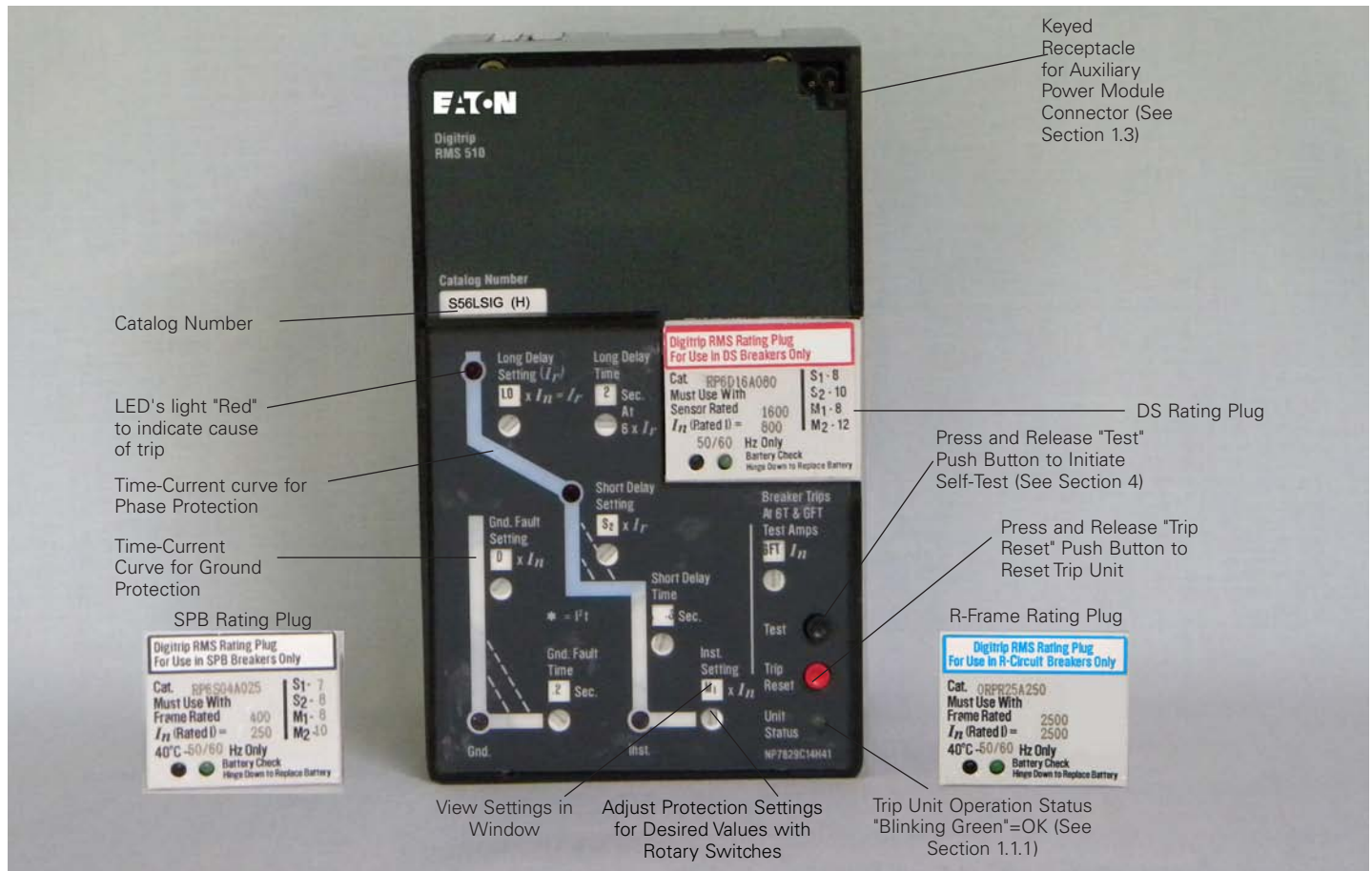

Figure 2. Digitrip RMS 510 Trip Unit Type LSIG with Rating Plug.

To check the status of the battery, see Section 4.5.

Note: The Digitrip RMS 510 performs all of its protection functions regardless of the status of the battery. The battery serves only to maintain the indication of the reason for automatic trip.

Press and release the "TRIP RESET" push-button shown in Figure 2, to turn "Off" the LEDs following a trip operation.

1.1.2 General Over-Current Protection

The Digitrip RMS 510 Trip Unit is completely self-contained and when the circuit breaker is closed, requires no external control power to operate its **protection systems**. It operates from current signal levels and control power derived through current sensors integrally mounted in the circuit breaker.

The Digitrip RMS 510 Trip Unit is available in six different types. Each Trip Unit may be equipped with a maximum of five phase and two ground (time-current) settings (see Section 3) to meet specific application requirements. The protection available for each type is summarized in the following table, and illustrated in Figures 3 thru 8:

Protection Functions	Type	Figure
Long Time / Instantaneous	LI*	3
Long Time / Short Time	LS*	4
Long Time /Short Time / Instantaneous	LSI*	5
Long Time / Instantaneous / Ground	LIG	6
Long Time / Short Time / Ground	LSG	7
Long Time / Short Time / Instantaneous / Ground	LSIG	8

Note: *RMS Digitrip Type LI, LS and LSI Trip Units can be applied on 3-pole or 4-pole circuit breakers for protection of the neutral circuit, IF the circuit breaker is wired and MARKED for NEUTRAL PROTECTION. Refer to the National Electric Code for appropriate application of 4-pole breakers.

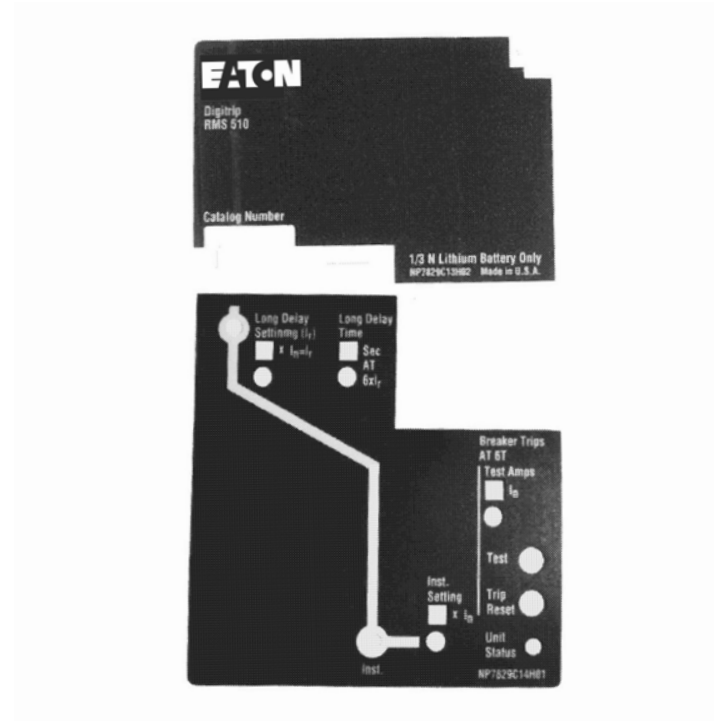

Figure 3. Digitrip RMS 510 Type LI.

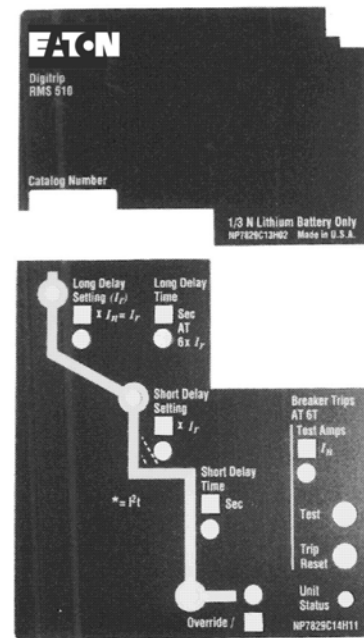

Figure 4. Digitrip RMS 510 Type LS.

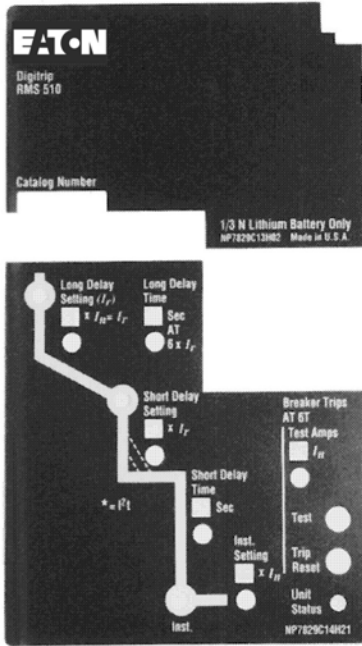

Figure 5. Digitrip RMS 510 Type LSI.

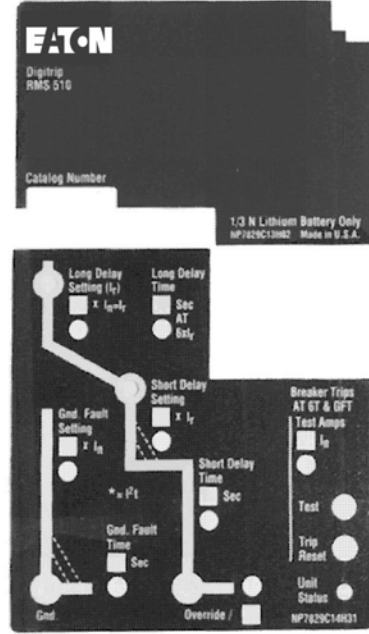

Figure 7. Digitrip RMS 510 Type LSG.

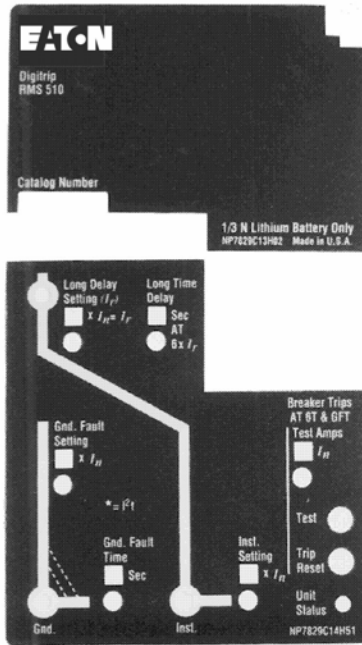

Figure 6. Digitrip RMS 510 Type LIG.

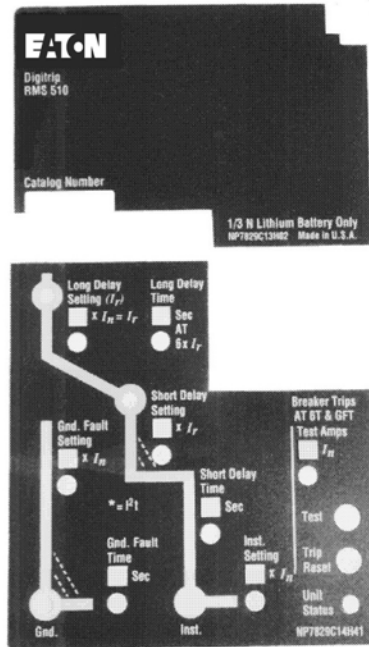

Figure 8. Digitrip RMS 510 Type LSIG.

⚠ NOTICE

AFTER EACH TRIP OPERATION (WHETHER DUE TO OVERCURRENT PROTECTION OR REMOTE CONTROL) THE AUTOMATIC LOCKOUT-AFTER-TRIP FEATURE OF THE DIGITRIP RMS 510 TRIP UNIT MAINTAINS THE CIRCUIT BREAKER IN A "TRIP-FREE" CONDITION, PROVIDED 120 VAC CONTROL POWER REMAINS AVAILABLE. THE TRIP UNIT MUST BE RESET BEFORE THE CIRCUIT BREAKER CAN BE CLOSED AGAIN. THE RESET CAN BE ACCOMPLISHED EITHER LOCALLY BY PRESSING AND RELEASING THE "TRIP RESET" PUSH BUTTON (SEE FIGURE 2).

1.1.3 Discriminator (High Initial Current Release) (For Types LS and LSG Trip Units Only)

When the Digitrip RMS 510 Trip Unit is not equipped with an adjustable instantaneous protection setting, i.e. types LS or LSG, a DIScriminator circuit (or high initial current release) is provided. The non-adjustable release is pre-set at eleven (11) times the installed rating plug current (I_n). The DIScriminator is enabled for approximately ten (10) cycles following the initial current flow through the circuit breaker, provided the load current exceeds approximately 10% of the circuit breaker frame (or current sensor) rating. Whenever the load current falls below 10% the discriminator is rearmed. The release, once rearmed will remain enabled until the load current passing through the circuit breaker has exceeded the 10% value for 10 cycles. The DIScriminator trips the circuit breaker, instantaneously the "OVERRIDE / DIS" LED will light "RED."

In the event the breaker is not intended to trip out on a circuit whose current could initially be higher than $11 \times I_n$, it is possible to make the DIScriminator inactive.

If a circuit breaker would close onto a high short-circuit current, when the DIScriminator is inactive, type **LS** or **LSG** Trip Units will rely on the short-time delay function before tripping. If the fault current exceeds the short-time withstand current capability of the circuit breaker, the OverRIDE protection function will trip the breaker without delay (see Section 1.1.4). Also, please see Section 1.1.5 for other exceptions when Zone Interlocking is employed.

The DIScriminator (high initial current release) can be made inactive by turning the "OVERRIDE/" setting switch (nearest the bottom edge of the Trip Unit) from the "DIS" position, to the "[blank]" position (see Figures 4 and 7).

Note: This switch has eight (8) positions, and seven (7) of the positions show "DIS" in the window, ONLY ONE position shows "[blank]".

Note: When the "OVERRIDE/" window shows "[blank]", the only fast-acting high short-circuit protection available is the OVERRIDE (Fixed Instantaneous) (see Section 1.1.4).

1.1.4 OVERRIDE (Fixed Instantaneous)

Each Digitrip RMS 510 Trip Unit has a Fixed Instantaneous "Override" analog trip circuit pre-set to a value no greater than the short-time withstand current rating of the circuit breaker in which the Trip Unit is installed. Since the specific values vary for different circuit breaker types and ratings, refer to time-current curves, listed in Section 5, for the values applicable to your breaker. If the breaker trips due to high instantaneous current, the "OVERRIDE/" LED will light "RED".

1.1.5 Zone Interlocking

Zone Selective Interlocking (or Zone Interlocking) is available (see Figure 1) for Digitrip RMS Trip Units having Short Delay and/or Ground Fault protection. Zone Selective Interlocking provides the fastest possible tripping for faults within the breaker's zone of protection, and yet also provides positive coordination among all breakers in the system (mains, ties, feeders and downstream breakers) to limit the outage to the affected part of the system only. When Zone Interlocking is enabled, a fault within the breaker's zone of protection will cause the Trip Unit to:

- Trip the affected breaker instantaneously, and
- Send a signal to upstream RMS Digitrip Trip Units to restrain from tripping immediately. The restraining signal causes the upstream breakers to follow their set coordination times, so that only the minimum service is disrupted, while the fault is cleared in the shortest time possible.

This signal requires that only a single pair of wires be connected from the interlock output terminals of the downstream breaker's Trip Unit, to the interlock input terminals of the upstream breaker's Trip Unit. For specific instructions see the applicable connection diagrams for your breaker listed in Section 5.

Note: If a breaker (M) receives a Zone Interlocking signal from another breaker (F) that is tripping, but the fault current level is less than the setting for breaker (M), the presence of the Zone Interlocking signal from the other breaker (F) can not cause breaker (M) to trip.

⚠ CAUTION

IF ZONE INTERLOCKING IS NOT TO BE USED (I.E.: STANDARD TIME-DELAY COORDINATION ONLY IS INTENDED), THE ZONE INTERLOCKING TERMINALS MUST BE CONNECTED WITH JUMPER WIRES, AS SPECIFIED ON THE CONNECTION DIAGRAMS FOR YOUR BREAKER (SEE SECTION 5), SO THE TIME DELAY SETTINGS WILL PROVIDE THE INTENDED COORDINATION.

For examples of how Zone Selective Interlocking may be used, See Appendix A.

1.2 Frame Rating, Sensor Rating (Where Applicable) and Rating Plugs

The **Frame Rating** of a circuit breaker is the maximum RMS current it can carry continuously. The maximum Short-Circuit Current Ratings of the circuit breaker are usually related to the Frame Rating as well.

It is often times desirable to be able to choose a current value (I_n), less than the full frame rating, to be the basis for the circuit breaker's protection functions, without affecting its short-circuit current capability. For the Digitrip RMS 510 Trip Unit the maximum continuous current (I_n) is set by the **Rating Plug** (and/or **Current Sensors**, where applicable) - see Section 5 for specific instructions for your circuit breaker type.

The **(Current) Sensor Rating** (where applicable) is the maximum RMS current the circuit breaker can carry with the specified current sensors installed. The Sensor Rating can be the same or less than the Frame Rating, but not greater.

The **Rating Plug** (see Figure 9) fits into a special cavity to complete the Trip Unit (see Figure 2).

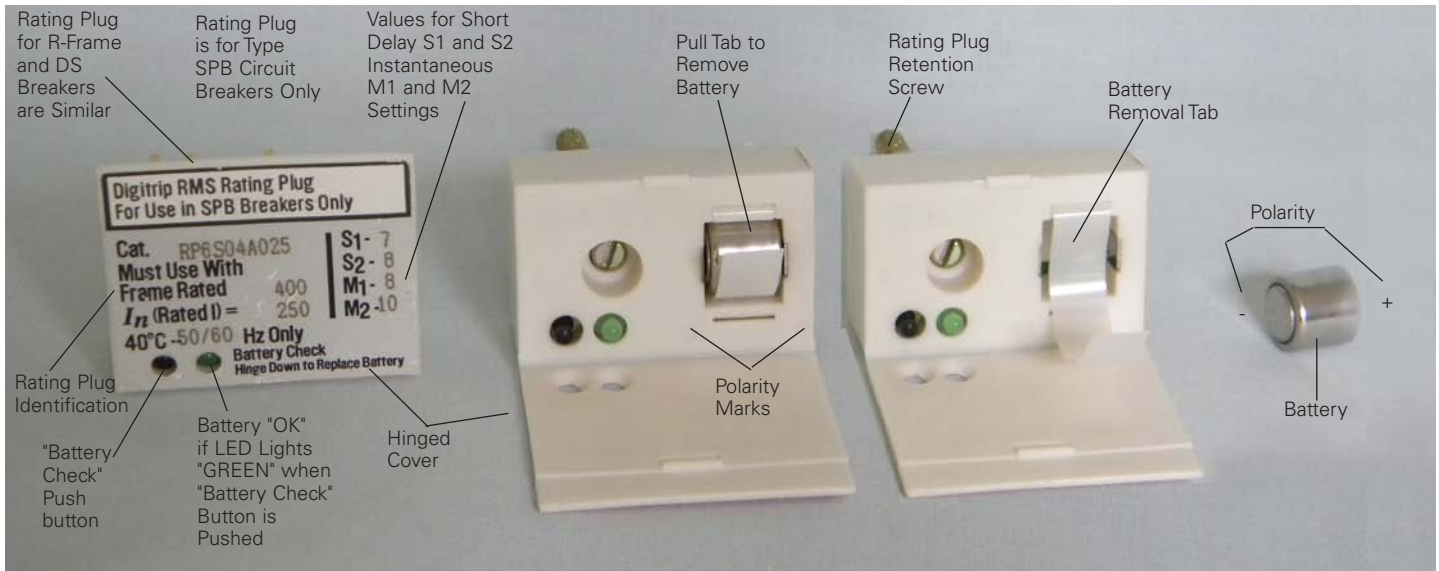

Figure 9. Rating Plug.

CAUTION

BEFORE YOU FIT THE RATING PLUG INTO THE TRIP UNIT, BE SURE TO CHECK THAT THE BREAKER TYPE AND FRAME RATING (OR SENSOR RATING IF APPLICABLE), MATCH THOSE PRINTED ON THE RATING PLUG COVER. INSTALLING A RATING PLUG THAT DOES NOT MATCH THE BREAKER TYPE AND FRAME RATING (OR SENSOR RATING, IF APPLICABLE), CAN PRODUCE SERIOUS MIS-COORDINATION AND/OR FAILURE OF THE PROTECTION SYSTEM.

After installing the Rating Plug, press and release the "TRIP RESET" push-button to turn off any illuminated LEDs. The purpose of the rating plug is to set the value of I_n , the basis for the Trip Unit protection function current settings (see Section 3 for details). Each circuit breaker frame rating represents the maximum current it can carry continuously. However for proper coordination of over-current protection, it is often desirable to choose different levels of I_n for different circuit breakers of the same frame rating. An assortment of rating plugs with different I_n values is available for each breaker frame rating (see circuit breaker instruction leaflet supplements listed in Section 5) to give the user flexibility to change the value of I_n without having to change the primary current sensors on the breaker. By changing the rating plug, the User can easily change the range of current protection settings without having to remove the circuit breaker from its enclosure.

For example, if one expects a circuit to carry 600 A initially, but then increase to 1400 A in the future, one could initially install 1600 A cables and a 1600 A breaker frame with the Trip Unit rating plug whose $I_n = 800$ A. Then later on when the additional load is ready to come on line, the rating plug could be exchanged for one with $I_n = 1600$ A, without having to remove the breaker from its enclosure. The available settings would give the following choices:

Long Delay Setting

$$I_r = I_n \times : .5 \ .6 \ .7 \ .8 \ .85 \ .9 \ .95 \ 1.0$$

Plug $I_n = 800$ A

LDPU $I_r = : 400 \ 480 \ 560 \ 640 \ 680 \ 720 \ 760 \ 800$ A

Plug $I_n = 1600$ A

LDPU $I_r = : 800 \ 960 \ 1120 \ 1280 \ 1360 \ 1440 \ 1520 \ 1600$ A

Note: Rating plugs from Digitrip models 500 / 600 / 700 / 800 CANNOT be used with model 510 Trip Units. The connection pins are located in different positions, so one cannot accidentally use the incorrect type of plug.

Rating Plugs for the Digitrip RMS 510 Trip Units are marked for, and may be applied on both 50 and 60 Hz systems.

Rating plugs have two current ratings listed on their covers (see Figure 9).

- The "Must Use With Frame Rated" current value (or "Sensor Rated", if applicable),

and

- " I_n (rated I)=" current value.

This latter value (I_n) is the basis for the Trip Unit current settings:

- The instantaneous and Ground Current Settings (if applicable) are multiples of (I_n) (see Sections 3.6 and 3.8.).
- The Long Delay Current Setting, I_r is a multiple of (I_n). Long Delay Current Setting = $I_r = LD \times (I_n)$ (see Section 3.2.).
- The Short Delay Current Setting (if provided) is a multiple of I_r which in turn is a multiple of (I_n). Short Delay Current Setting = $SD \times I_r = SD \times LD \times (I_n)$ (see Section 3.4).

If the rating plug is missing or not well connected the instantaneous / override LED will be lit. If the circuit breaker is closed, it will trip. If the rating plug condition is not corrected, as soon as the three-phase current through the circuit breaker reaches 20% (40% if single-phase current) of the frame / current sensor rating, the Trip Unit will trip the breaker again.

As indicated in Figures 2 and 9, a back-up battery is provided to maintain the mode of trip LED indication in the Digitrip RMS 510 Trip Unit when external control power to the Power / Relay module is not available. The back-up battery is located in the rating plug along with a battery check push-button and a green battery check LED. The battery in the rating plug is "OK" if the LED lights "Green" when the "battery check" button next to it is pushed (see Section 4.5).

Note: The back-up battery is used only to maintain the cause of TRIP LED indication. It has NO part in the PROTECTION FUNCTION of the Trip Unit.

1.3 Auxiliary Power Module

The Auxiliary Power Module or APM (Cat. No. PRTAAPM), illustrated in Figure 10, is an encapsulated power supply that requires a 120 Vac input at either 50 or 60 Hz. It provides an output of 32 Vdc (nominal 40 Vdc open circuit) which is used during testing of the Digitrip RMS 510 Trip Unit. When a drawout circuit breaker is equipped with a Digitrip RMS 510 Trip Unit, it can be conveniently set and tested while the circuit breaker is either out of its cell or in its cell in the "Test", "Disconnect", or "Withdrawn" positions by using the Auxiliary Power Module.

The Auxiliary Power Module is equipped with a unique plug-in connector suitable only for plugging in to the keyed receptacle in the upper right corner of a Digitrip RMS Trip Unit as shown in Figure 2. This avoids the inadvertent use of an incorrect type power module.

The APM is suitable for use with older Digitrip RMS 500, 600, 700, 800, as well as newer RMS 510, 610, 810, and 910 Models.



Figure 10. Auxiliary Power Module.

2 UL Listed Devices

Digitrip RMS 510 Trip Units are "Listed" by the Underwriters Laboratories, Inc.® under UL File E7819, for use in types DS, DSL, SPB, and Series C® R-Frame circuit breakers.

3 Protection Settings

3.1 General

Prior to placing any circuit breaker in operation, each Trip Unit protection setting must be set to the values specified by the person responsible for the installation. The number of settings that must be made is determined by the protection supplied as illustrated in Figures 11 through 18. Each setting is made with a rotary switch, using a small screwdriver. The selected setting for each adjustment appears in its respective rectangular viewing window as illustrated in Figure 2.

The installed rating plug establishes the maximum continuous current rating (I_n), up to, but not exceeding the Frame Rating of the circuit breaker. Instantaneous and ground current settings are defined in multiples of (I_n).

To illustrate the effect of each protection curve setting, simulated Time-Current curves are pictured on the face of the Trip Unit. The rotary switch used to make each setting is located nearest that portion of the simulated Time-Current curve it controls. Should an automatic "TRIP" occur (as a result of the current exceeding the pre-selected value), the LED in the appropriate segment of the simulated Time-Current curve will light "RED", indicating the reason for the "TRIP".

The available settings, along with the illustrated effect of changing the settings are given in Figures 11 through 18.

3.2 Long Delay Current Setting

There are eight (8) available Long Delay "Pick-up" Current Settings, as illustrated in Figure 11. Each setting, called " I_r ", is expressed as a multiple (ranging from 0.5 to 1) of the rating plug current (I_n).

Note: " I_r " is also the basis for the Short-Delay Current Setting (see Section 3.4).

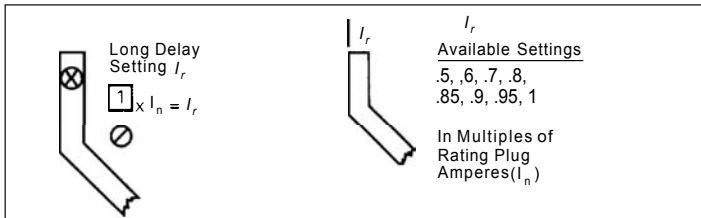

Figure 11. Long Delay Current Settings.

3.3 Long Delay Time Setting

There are eight (8) available Long Delay Time Settings, as illustrated in Figure 12, ranging from 2 to 24 seconds. These settings are the total clearing times in seconds, when the current value equals six (6) times I_r . The (LS) Time-Current Curve applicable for your circuit breaker gives complete details (see Section 5).

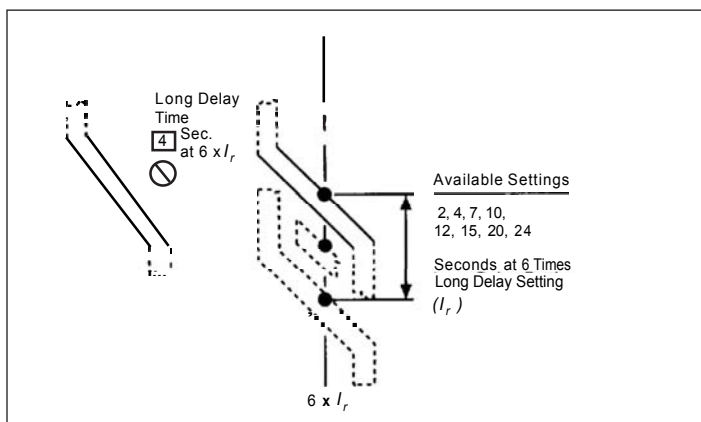

Figure 12. Long Delay Time Settings.

Note: In addition to the standard Long Delay Protection Element, the Digitrip RMS 510 Trip Unit also has a Long Time Memory (LTM) function, which serves to protect load circuits from the effects of repeated overload conditions. If a breaker is re-closed soon after a Long Delay Trip, and the current again exceeds the Long Delay Current Setting, I_r , the LTM automatically reduces the time to trip, to allow for the fact that the load circuit temperature is already higher than normal, due to the prior overload condition. Repeated overload can cause LTM to trip the breaker after a time delay less than the "Long Delay Time Setting." When the load current returns to normal, the LTM begins to reset; and after about 10 minutes it has reset fully, so that next Long Delay trip time will again be the "Setting" value. To reset the LTM quickly, see Section 4.4, Item 3.

In certain applications it may be desirable to disable the LTM function. The LTM function can be disabled by (first opening the breaker and then) removing the Rating Plug and lastly moving the LTM jumper (inside the rating plug cavity, see Figure 13) to its "INACTIVE" connection. (You can enable the LTM function again any time you wish by moving the LTM jumper back to its original "ACTIVE" connection.)

The action of the LTM is a factor to consider in performing multiple Long Delay Time tests. (See Section 4.4.)

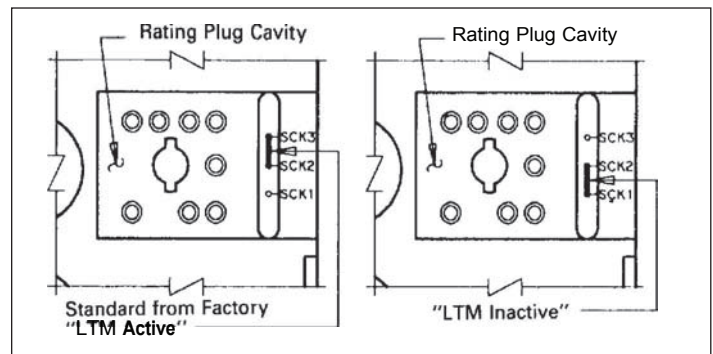

Figure 13. Long Time Memory "LTM" Jumper.

Note: There is a condition under which the Long Delay Trip LED can erroneously indicate a LDT has occurred, even though the breaker is still closed. This can happen when an overload current momentarily exceeds the Long Delay Current Setting, I_r , so that the Long Delay LED flashes "RED" to indicate the overload condition. Then if, at the very moment when the LED is "ON", the load current would then suddenly drop to a value less than 10% of the breaker frame (or current sensor) rating, the trip unit stops functioning while the "4bit Latch Chip" (See Fig. 1) is set and the LED remains lit. If the current would again increase to a value above the Long Delay Current Setting, I_r , and then return to normal, the LDT will reset itself. You can of course, manually clear the LDT (or any other trip indication) at any time, by pushing the "PUSH to RESET" button. (See Figure 2.)

3.4 Short Delay Current Setting

There are eight (8) available Short Delay "Pick-up" Current Settings, as illustrated in Figure 14. Six settings are in the range from 2 to 6 times I_r and the other two settings are "S1" or "S2" times I_r (REMEMBER: I_r is the Long Delay Current Setting). The values that "S1" and "S2" have depend upon the type of circuit breaker, and are specified both on the rating plug label (see Figure 9) and on the applicable (LS) Time-Current Curve referenced in Section 5.

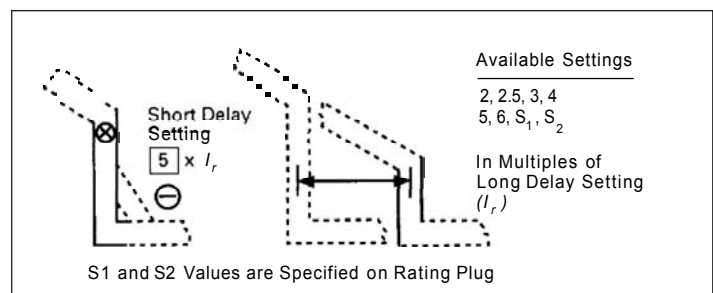

Figure 14. Short Delay Current Settings.

3.5 Short Delay Time Setting

As illustrated in Figure 15, there are two different Short Delay curve shapes, i.e., fixed time (flat) and I^2t response. The shape selected depends on the type of selective coordination chosen. The I^2t response will provide a longer time delay in the low-end of the short delay current range than will the flat response.

Five flat (.1, .2, .3, .4, .5 sec.) and three I^2t (.1*, .3*, .5* sec.) response time delay settings are available. The I^2t response settings are identified by the suffix asterisk (*) that appears in the setting viewing window. The I^2t response is applicable to currents less than eight (8) times I_r the Long Delay Setting. For currents greater than 8 times I_r the I^2t response reverts to the flat response.

Note: See also Section 1.1.5, Zone Interlocking.

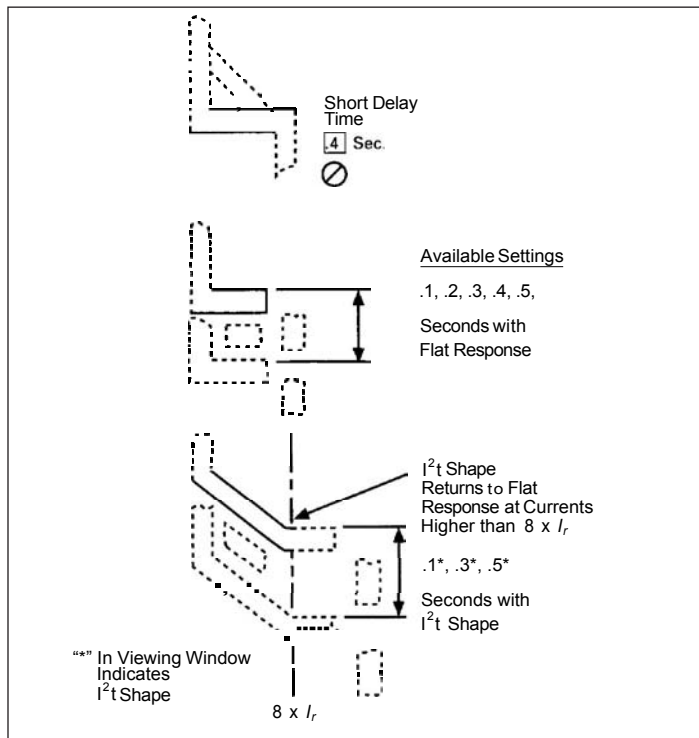

Figure 15. Short Delay Time Settings.

3.6 Instantaneous Current Setting

There are eight (8) available Instantaneous Current Settings, as illustrated in Figure 16. Six settings are in the range from 2 to 6 times the rating plug value (I_n), and the other two settings are "M1" and "M2" times (I_n). The values that "M1" and "M2" have depend upon the type of circuit breaker, and are specified both on the rating plug label (see Figure 9), and on the applicable (I) Time-Current Curve referenced in Section 5.

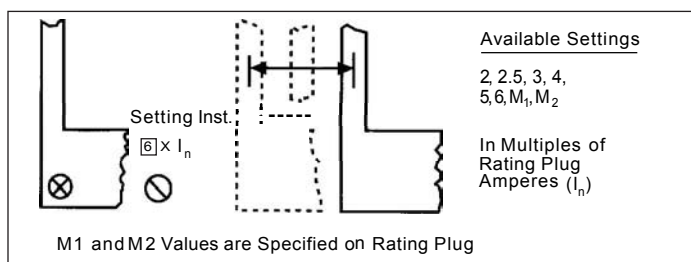

Figure 16. Instantaneous Current Settings.

3.7 No Instantaneous Current Setting

For types LS and LSG Trip Units, please see Sections 1.1.3 DIScriminator (High initial Current Release) and 1.1.4 OVERRIDE (Fixed Instantaneous), for available fast-acting high short-circuit protection.

3.8 Ground Fault Current Setting

The eight (8) Ground Fault "Pick-up" Current Settings are labeled with the code letters "A" through "K" (except there are no "G" or "I" settings), as illustrated in Figure 17. In general, the specific current settings range from 0.25 to 1.0 times (I_n), the rating plug value, but cannot exceed 1200 A. The specific Ground Current Settings for each letter are listed in Table 1 and on the (G) Time-Current Curve applicable for the circuit breaker (see Section 5).

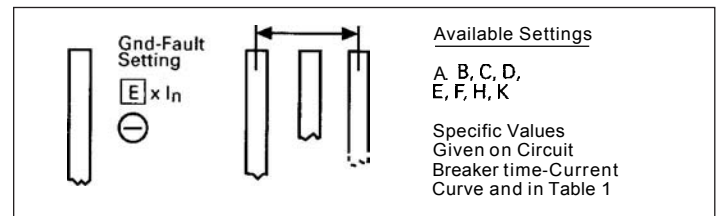

Figure 17. Ground Fault Settings.

Table 1. Ground Fault Current Settings.

		Ground Fault Current Settings							
		(Amperes) ^①							
		A	B	C	D	E	F	H	K
Installed Rating Plug (Amperes) I_n ^②	100	25	30	35	40	50	60	75	100
	200	50	60	70	80	100	120	150	200
	250	63	75	88	100	125	150	188	250
	300	75	90	105	120	150	180	225	300
	400	100	120	140	160	200	240	300	400
	600	150	180	210	240	300	360	450	600
	630	158	189	221	252	315	378	473	630
	800	200	240	280	320	400	480	600	800
	1000	250	300	350	400	500	600	750	1000
	1200	300	360	420	480	600	720	900	1200
	1250	312	375	438	500	625	750	938	1200
	1600	400	480	560	640	800	960	1200	1200
	2000	500	600	700	800	1000	1200	1200	1200
	2400	600	720	840	960	1200	1200	1200	1200
	2500	625	750	875	1000	1200	1200	1200	1200
	3000/3150	750	900	1050	1200	1200	1200	1200	1200
3200	800	960	1120	1200	1200	1200	1200	1200	
4000	1000	1200	1200	1200	1200	1200	1200	1200	
5000	1200	1200	1200	1200	1200	1200	1200	1200	

① Tolerances on settings are $\pm 10\%$ of values shown.
 ② Refer to Type DS, Type SPB, or Series C R-Frame supplemental instruction leaflets given in Section 5 for list of available rating plugs for each type circuit breaker.

Note: For Testing Purposes Only: When using an external single phase current source to test low level ground fault current settings, it is advisable to use the Auxiliary Power Module (APM) (see Section 1.3 and Figure 10). Especially when the single phase current is low, without the APM it may appear as if the trip unit does not respond until the current is well above the set value, leading the tester to believe there is an error in the trip unit when there is none. The reason this occurs is that the single phase test current is not a good simulation of the normal three phase circuit. If three phase current had been flowing, the trip unit would actually have performed correctly. Use the APM for correct trip unit performance whenever single phase tests are made..

3.9 Ground Fault Time Delay Setting

As illustrated in Figure 18, there are two different Ground Fault curve shapes, i.e., fixed time (flat) and I^2t response. The shape selected depends on the type of selective coordination chosen. The I^2t response will provide a longer time delay in the low-end of the ground fault current range than will the flat response.

Five flat (.1, .2, .3, .4, .5 sec.) and three I^2t (.1*, .3*, .5* sec.) response time delay settings are available. The I^2t response settings are identified by the suffix asterisk (*) that appears in the setting viewing window. The I^2t response is applicable to currents less than $0.625 \times I_n$, (the I_n value is marked on the installed rating plug). For currents greater than $0.625 \times I_n$, the I^2t response reverts to the flat response.

Note: See also Section 1.1.5 on Zone Interlocking.

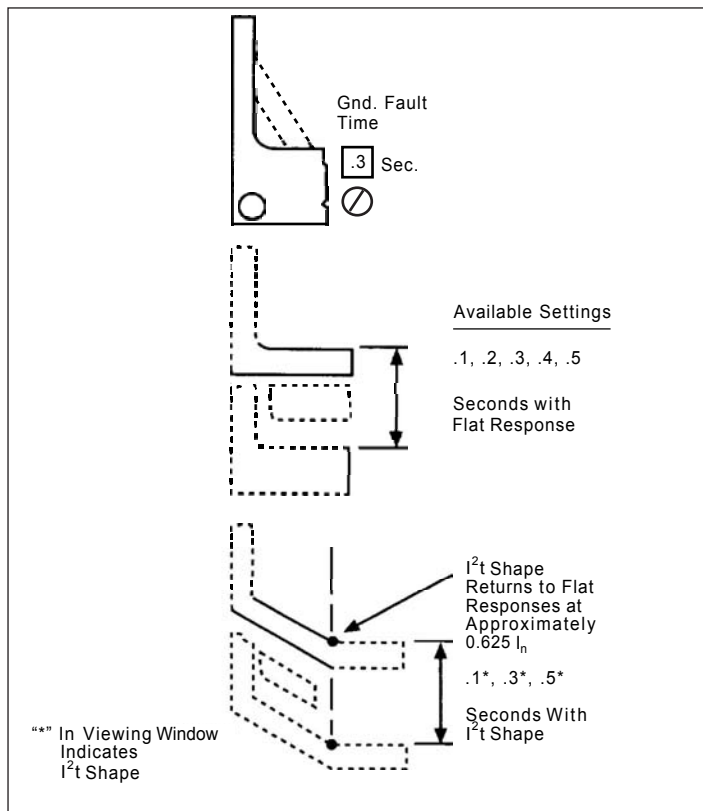

Figure 18. Ground Fault Time Delay Settings.

4 Test Procedures

4.1 General

⚠ DANGER

DO NOT ATTEMPT TO INSTALL, TEST OR PERFORM MAINTENANCE ON EQUIPMENT WHILE IT IS ENERGIZED. DEATH OR SEVERE PERSONAL INJURY CAN RESULT FROM CONTACT WITH ENERGIZED EQUIPMENT.

DE-ENERGIZE THE CIRCUIT AND DISCONNECT THE CIRCUIT BREAKER BEFORE PERFORMING MAINTENANCE OR TESTS.

REFER TO THE APPLICABLE CIRCUIT BREAKER INSTRUCTION LEAFLET SUPPLEMENT (LISTED IN SECTION 5) FOR COMPLETE INSTRUCTIONS.

⚠ CAUTION

TESTING A CIRCUIT BREAKER UNDER "TRIP CONDITIONS" WHILE IT IS IN SERVICE AND CARRYING LOAD CURRENT, WHETHER DONE BY LOCALLY OR BY REMOTE MEANS, IS NOT RECOMMENDED.

ANY TRIPPING OPERATION WILL CAUSE DISRUPTION OF SERVICE AND POSSIBLE PERSONAL INJURY RESULTING FROM UNNECESSARY SWITCHING OF CONNECTED EQUIPMENT.

TESTING OF A CIRCUIT BREAKER THAT RESULTS IN THE TRIPPING OF THE CIRCUIT BREAKER SHOULD BE DONE ONLY WITH THE CIRCUIT BREAKER IN THE "TEST" OR "DISCONNECTED" CELL POSITIONS OR WHILE THE CIRCUIT BREAKER IS ON A TEST BENCH.

4.2 When To Test

Tests can be conducted with the breaker in the "connected" cell position while carrying load current. However, as stated in the caution note in Section 4.1, good practice will limit circuit breaker in-service "trip tests", where required, to maintenance periods during times of minimum load conditions. Testing is accomplished with the breaker out of its cell or in the "Test", "Disconnected", or "Withdrawn" (or Removed) cell positions.

Note: Since time-current settings are based on desired system coordination and protection schemes, the protection settings selected and preset in accordance with Section 3 should not be altered during or as a part of any routine test sequence.

4.3 Testing Provisions

As indicated in Figure 19, six different "Test Amps" settings (1, 2, 3, 6T, 8 and $10 \times I_n$) are available for testing the phase elements of the Trip Unit, and two settings (GF and GFT) are provided for testing the ground element.

⚠ CAUTION

A SETTING OF EITHER 6T OR GFT WILL TRIP THE CIRCUIT BREAKER (SEE SECTIONS 4.1 AND 4.4.3).

FOR ANY COMBINATION OF THE PHASE PROTECTION SETTINGS, AN APPROPRIATE "NO TRIP" CONDITION CAN BE SET TO TEST THE LONG TIME, SHORT TIME, AND INSTANTANEOUS TRIP SETTINGS WITHOUT TRIPPING THE CIRCUIT BREAKER (SEE SECTION 4.4.2).

IN THE "GF" TEST POSITION, THE LEVEL OF TEST CURRENT, BASED ON I_n , IS ADEQUATE TO DEMONSTRATE THE OPERATING CONDITION OF THE TRIP UNIT WITHOUT TRIPPING THE CIRCUIT BREAKER. THIS IS A FUNCTIONAL CHECK ONLY, NOT A CALIBRATION.

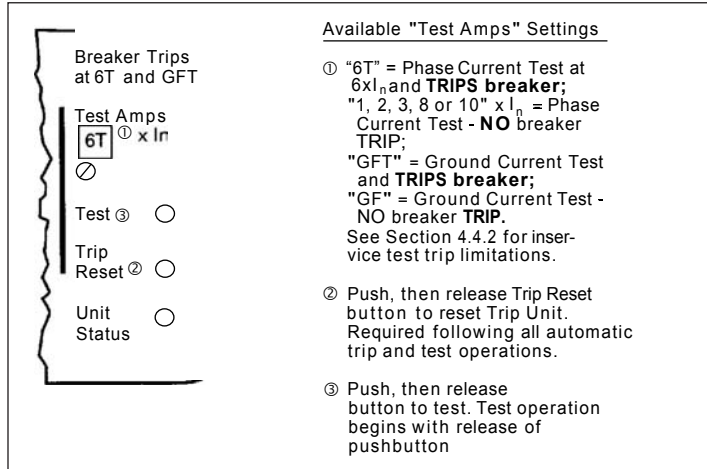

Figure 19. Integral Test Panel (Lower Right Corner of Trip Unit).

4.4 Conducting Tests

To preserve the primary protection function of the Trip Unit, all in-service testing whether under "Trip" or "No-Trip" conditions is executed ONLY if load current values are no greater than 50% x I_r (I_r = the Long Delay Current Setting). **Any attempt to conduct in-service testing when the load current exceeds 50% of I_r will NOT be executed by the Trip Unit.**

Since the Digitrip RMS 510 Trip Unit is completely self-powered using energy derived from the current sensors installed in the circuit breaker, all in-service tests conducted should be conducted with the auxiliary control power module, shown in Fig. 10, plugged into the trip unit. This action will avoid difficulties caused by load current levels that are too low to operate the trip unit.

1. **Before starting any test sequence, check the Unit Status (Green LED) in the lower right corner of the Trip Unit (see Figures 2 and 19) to be sure it is blinking on and off about once each second, which indicates that the Trip Unit is functioning normally.** In the event the Unit Status LED is not blinking, install an Auxiliary Power Module (APM) (see Figure 10), or if you have already installed one, check to see that it is connected correctly (see Section 1.3).
2. **If the circuit breaker is carrying current,** check that the current is not:
 - a. more than 50% of the Long Delay Current Setting (I_r); because the Trip Unit will not execute your test instructions when it senses that the current through the breaker exceeds the 50% level. If the current through the circuit breaker increases to a value greater than 50% of the Long Delay Current Setting, I_r, the Trip Unit will automatically abort any Trip Unit Test that may be in progress. Should an actual overload or fault condition occur during an in-service, test sequence, the protection function will override the test function, and the circuit breaker will trip automatically in accordance with the actual Time-Current settings.
 - b. the current is not less than 10% of the breaker frame (or current sensor) rating; be sure the "GREEN" Unit Status LED (in the lower right corner of the trip unit (See Figs. 2 and 19) is blinking on and off (indicating that there is enough current flowing to provide the power necessary to operate the trip unit). In the event the Unit Status LED is either lit "GREEN" or "OFF" continuously, there is NOT enough current flowing to power the trip unit; and an APM (See Fig. 10) should be installed before proceeding with the test.

3. **When performing tests on the Long Delay element, be aware that in addition to the standard protection element, the Digitrip RMS 510 Trip Unit also has a Long Time Memory function (LTM),** which serves to protect load circuits from the effects of repeated overload conditions (see Note 1 under Section 3.3 Long Delay Time Setting). The action of the LTM during primary injection tests and during tests initiated from the Trip Unit Test Panel under the "TEST AMPS" setting of "6T", will advance the Long Delay Trip Time if multiple Long Delay Time tests are performed repeatedly - as one might do in making single-phase tests on each pole of a breaker in succession, for example. If there is any question, you may simply wait about ten (10) minutes after a Long Delay Trip for the LTM to reset. The LTM is not active during tests initiated from the Trip Unit Test Panel under the "TEST AMPS" settings of "1", "2", "3", "8", or "10".

To reset the LTM immediately:

- Set the "TEST AMPS" to "1".
- Press and release the (Black) "TEST" push-button (timer will be running in the display window), and then
- Quickly press and release the "TRIP RESET" push-button before the Trip Unit operates.
- Now the LTM will be reset.

4.4.1 Control Power

For testing the trip unit, an optional Auxiliary Power Module (Cat. No. PRTAAPM) as shown in Fig. 7 is recommended. This Auxiliary Power Module, which operates from a separate 120 Vac supply, may be used when a drawout circuit breaker is in any of its four cell positions, i.e., "Connected", "Test", "Disconnected" and "Withdrawn" (or "Removed.")

Note: For Testing Purposes Only: When using an external single phase current source to test low level ground fault current settings, it is advisable to use the Auxiliary Power Module (APM) (See Fig. 10). Especially when the single phase current is low, without the APM it may appear as if the trip unit does not respond until the current is well-above the set value, leading the tester to believe there is an error in the trip unit when there is none. The reason this occurs is that the single phase test current is not a good simulation of the normal three phase circuit. If three phase current had been flowing, the trip unit would actually have performed correctly. Use the APM for correct trip unit performance whenever single phase tests are made.

Plug in the Auxiliary Power Module (Cat. No. PRTAAPM) to insure control power is available for testing. When the APM is properly connected the "GREEN" Unit Status LED will blink on and off about once per second.

4.4.2 Not Tripping the Breaker

1. Place the "TEST AMPS" selector switch (see Figure 19) in one of the six "No Trip" test settings, i.e., 1, 2, 3, 8, or 10 x I_n, or GF.
2. Press and release the (Black) "TEST" push-button - the test starts when the push-button is released. When the timer stops, the lit "RED" cause of trip LED indicates the protection function which operated.
3. Should any of the various protection settings be less than the selected "No Trip" test value, then the LED related to that function will turn on signifying successful completion of the test action.

Note: During the long delay tests the Long Delay LED flashes "RED".

4. Reset the Trip Unit by pressing and releasing the "TRIP RESET" push-button; all LEDs lit by the "No Trip" test action should turn "OFF". In the event that no one resets the Trip Unit after a test, it will wait for about three (3) hours, and then it will automatically revert back to its pretest status.

Should an actual overload or fault condition occur during an in-service, "No Trip Test" sequence, the protection function will override the test function, and the circuit breaker will trip automatically in accordance with the actual Time-Current settings.

Note: The "Trip Reset" button may be pushed down at any time. However, should a test already be in progress, the test would be aborted.

4.4.3 Tripping the Breaker

WARNING

CIRCUIT BREAKER OPERATING MECHANISMS OPEN AND CLOSE THE MOVING PARTS VERY FAST, AND WITH VERY HIGH ENERGY. TOUCHING THE MOVING PARTS DURING TEST OPERATIONS CAN CAUSE INJURY. KEEP CLOTHING, HANDS, FEET, AND OTHER PARTS OF YOUR BODY WELL AWAY FROM ALL MOVING PARTS DURING TESTING. FOLLOW THE INSTRUCTIONS GIVEN FOR TESTING YOUR SPECIFIC TYPE OF CIRCUIT BREAKER, FOUND IN THE APPROPRIATE INSTRUCTION LEAFLET LISTED IN SECTION 5.

1. Make sure that the circuit breaker is carrying no current (see CAUTION notes under Section 4.1).

Note: In the event it is decided to perform a "Breaker Trip Test" while load current is flowing, make sure the circuit breaker is carrying no more than 50% of the Long Delay Current Setting I_r . The Trip Unit will NOT execute your instructions to Test itself, when the load current exceeds 50% of I_r .

2. Place the "TEST AMPS" selector switch (see Figure 19) in either the "6T (or "GFT) position.
3. Press and release the (Black) "TEST" push-button (see Figure 19) - the test starts when the push-button is released.
4. Should any of the various protection settings be less than the selected "Test Amps" value, the circuit breaker will trip and the LED related to that function will light "RED".
5. Reset the Trip Unit by pressing and releasing the "Trip Reset" push-button (see Figure 19). All LEDs lit by the "Trip" test action should turn "OFF".

4.5 Testing the Battery (Inside the Rating Plug)

The battery has no part in the protection function of the Trip Unit.

The battery is provided only to maintain the "RED" LED indication of the cause of TRIP in the Digitrip RMS 510 Trip Unit. The battery is located in the rating plug along with a battery check push-button and a green battery check LED (see Figure 9).

4.5.1 Back-up Battery Check

The battery is a long life, lithium photo type unit. The status of the battery can be checked at any time. Press and hold the "battery check push-button and observe the "Green" LED as shown in Figure 9. If the battery check LED does not light "Green", replace the battery. The condition of the battery has no effect on the protection function of the Trip Unit. Even with the battery removed, the unit will still trip the breaker in accordance with its settings. If however, the battery is dead, the cause of TRIP LED will not be lit "RED".

4.5.2 Replacing the Back-up Battery

The battery can be easily replaced from the front of the Trip Unit by lowering the hinged cover of the rating plug as shown in Figure 9. The battery can then be removed by pulling the battery tab as shown in Figure 9. After the battery is replaced (or after an Auxiliary Power Module is plugged into the Trip Unit), one or more of the cause of Trip LED'S may be illuminated. It is necessary to press and release the "TRIP RESET button to turn off any of the LEDs that may be illuminated. Failure to do so can cause the battery to run down again. The Trip Unit will then be ready to indicate the next cause of trip.

Note: The battery can be replaced at any time, even while the circuit breaker is in service, without affecting the operation of the circuit breaker or its protection function.

CAUTION

CARE SHOULD BE EXERCISED WHEN REPLACING THE BATTERY TO INSURE THAT THE CORRECT POLARITY IS OBSERVED. POLARITY MARKINGS ARE VISIBLE ON THE RATING PLUG WHEN THE HINGED COVER IS OPEN AS INDICATED IN FIGURE 9. IF THE BATTERY IS INSERTED WITH INCORRECT POLARITY, THEN, AFTER AN OVER CURRENT OR SHORT-CIRCUIT TRIP, NO LEDS WILL BE LIT RED TO INDICATE THE REASON FOR THE TRIP.

The replacement battery should be the same type or equivalent. Acceptable 3.0 volt lithium batteries may be obtained as type designation CR 1/3N or DL 1/3N.

5 References

5.1 Digitrip RMS Trip Assemblies

I.L. 29-885	Instructions for Digitrip RMS 510 Trip Unit
I.L. 29-886	Instructions for Digitrip RMS 610 Trip Unit
I.L. 29-888	Instructions for Digitrip RMS 810 Trip Unit
I.L. 29-889	Instructions for Digitrip RMS 910 Trip Unit

5.2 Type DS Low-Voltage AC Power Circuit Breakers

I.B. 33-790-1	Instructions for Low Voltage Power Circuit Breakers Types DS and DSL
Supplement B to I.B. 32-790-1	Digitrip RMS 510, 610, and 910 Trip Units with Types DS and DSL Low Voltage Power Circuit Breakers
AD 32-870	Typical Time-Current Characteristic Curves for Types DS and DSL Circuit Breakers
SC-5619	Instantaneous (I)
SC-5620	Long Delay and Short Delay (LS)
SC-5621	Ground (G)
508B508	Connection Diagram for Type DS Circuit Breakers

5.3 Type DS II Low-Voltage AC Power Circuit Breakers

I.B. 694C694	Instructions for Low Voltage Power Circuit Breakers Types DS II and DSL II.
Supplemental I.L. 8700C39	Digitrip RMS and Optim Trip Units with Type DS II and DSL II Low-Voltage AC Power Circuit Breakers
AD 32-870	Typical Time-Current Characteristic Curves for Types DS II and DSL II Circuit Breakers
SC-5619	Instantaneous (I)
SC-5620	Long Delay and Short Delay (LS)
SC-5621	Ground
IA33600	Connection Diagram for Type DS II Circuit Breakers

5.4 Type SPB Systems Pow-R Breakers

I.L. 29-801	Instruction for the Systems Pow-R Breaker and Drawout Mechanism
I.L. 29-849	Supplementary Instructions for the Systems Pow-R Breaker used with the Digitrip RMS Trip Units
AD 29-863	Typical Time-Current Characteristic Curves for Type SPB Systems Pow-R Breaker
86-5623-93	Instantaneous (I)
86-5624-93	Long Delay and Short Delay (LS)
86-5625-93	Ground (G)
I.S. 15545	SPB Master Connection Diagram

5.5 Series C® R-Frame Molded Case Circuit Breakers

29C106	Frame Book
29C107	Frame Instruction Leaflet
29C713	Supplementary Instructions for Series C® R-Frame used with the Digitrip RMS Trip Units
AD 29-167R	Typical Time-Current Characteristic Curves for R-Frame Circuit Breakers
SC-5626-93	Instantaneous (I)
SC-5627-93	Long Delay and Short Delay (LS)
SC-5628-93	Ground (G)
I.L. 29C714	Master Connection Diagram for Series C® R-Frame Circuit Breakers

APPENDIX A: Zone Interlocking

Assume a ground fault of 2000 Amperes occurs and refer to Figure A.1.

CASE 1: There is no Zone Selective Interlocking (standard time delay coordination is used).

Fault 3

The branch breaker will trip clearing the fault in 0.1 s.

Fault 2

The feeder breaker will trip clearing the fault in 0.3 s.

Fault 1

The breaker will trip clearing the fault in 0.5 s.

CASE 2: There is Zone Selective Interlocking.

Fault 3

The branch breaker trip unit will initiate the trip in 0.03 s to clear the fault and Z3 will send an interlocking signal to the Z2 trip unit; and Z2 will send an interlocking signal to Z1.

Z1 and Z2 trip units will begin to time out, and in the event that the branch breaker Z3 would not clear the fault, the feeder breaker Z2 will clear the fault in 0.3 s (as above). Similarly, in the event that the feeder breaker Z2 would not clear the fault, the main breaker Z1 will clear the fault in 0.5 s (as above).

Fault 2

The feeder breaker trip unit will initiate the trip in 0.03 s to clear the fault; and Z2 will send an interlocking signal to the Z1 trip unit. Z1 trip unit will begin to time out, and in the event that the feeder breaker Z2 would not clear the fault, the main breaker Z1 will clear the fault in 0.5 s (as above).

Fault 1

There are no interlocking signals. The main breaker trip unit will initiate the trip in 0.03 s.

Figure A.2 presents a Zone Selective Interlocking connection diagram for a system with two main breakers from incoming sources and a bus tie breaker. Note the blocking diode D1 is needed so that the feeder breakers can send interlocking signals to both the main and tie breakers, without having the tie breaker send itself an interlocking signal.

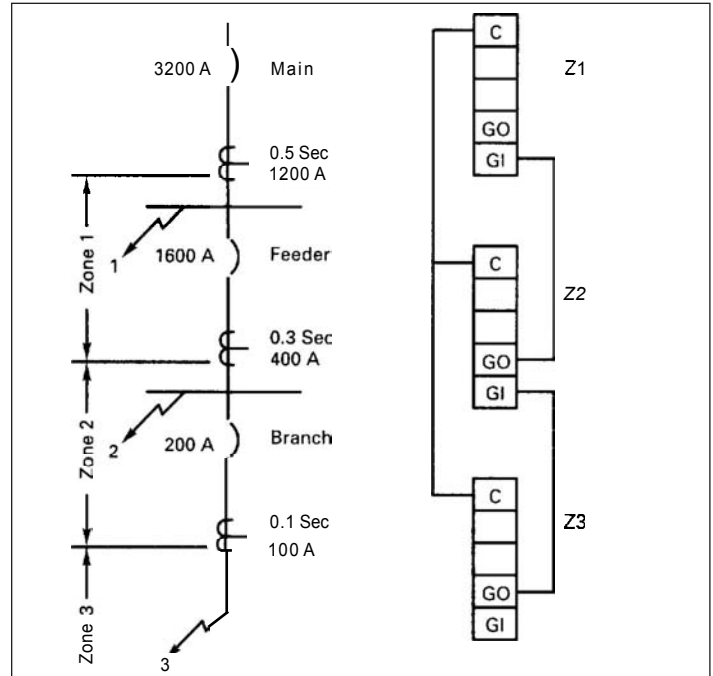

Figure A.1 Typical Zone Interlocking (Ground Fault Protection).

Notes: A1: Wiring to be twisted pair of AWG No. 14 to AWG No. 20. Route Zone Interlocking wiring separate from power conductors. DO NOT GROUND any Zone Interlock Wiring.

A2: The maximum distance between first and last zone is 250 feet (110 m).

A3: A Maximum of 20 breakers may be connected in parallel in one Zone.

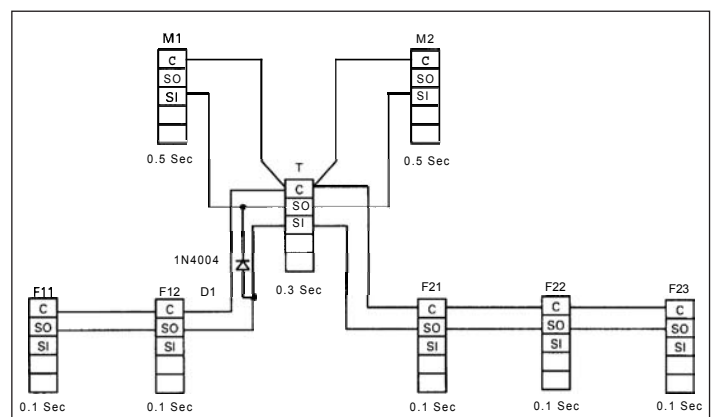
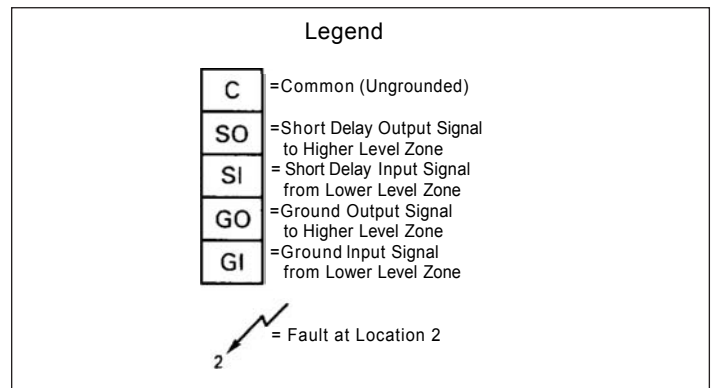

Figure A.2 Typical Zone Interlocking Connections with Two Main Breakers (M1, M2) and a Tie Breaker (T) (Short Delay Protection).

Notes:

Notes:

Notes:

This instruction leaflet is published solely for information purposes and should not be considered all-inclusive. If further information is required, you should consult an authorized Eaton sales representative.

The sale of the product shown in this literature is subject to the terms and conditions outlined in appropriate Eaton selling policies or other contractual agreement between the parties. This literature is not intended to and does not enlarge or add to any such contract. The sole source governing the rights and remedies of any purchaser of this equipment is the contract between the purchaser and Eaton.

NO WARRANTIES, EXPRESSED OR IMPLIED, INCLUDING WARRANTIES OF FITNESS FOR A PARTICULAR PURPOSE OR MERCHANTABILITY, OR WARRANTIES ARISING FROM COURSE OF DEALING OR USAGE OF TRADE, ARE MADE REGARDING THE INFORMATION, RECOMMENDATIONS, AND DESCRIPTIONS CONTAINED HEREIN.

In no event will Eaton be responsible to the purchaser or user in contract, in tort (including negligence), strict liability or otherwise for any special, indirect, incidental or consequential damage or loss whatsoever, including but not limited to damage or loss of use of equipment, plant or power system, cost of capital, loss of power, additional expenses in the use of existing power facilities, or claims against the purchaser or user by its customers resulting from the use of the information, recommendations and description contained herein.

Eaton Corporation
Electrical Sector
1111 Superior Ave.
Cleveland, OH 44114
United States
877-ETN-CARE (877-386-2273)
Eaton.com

© 2011 Eaton Corporation
All Rights Reserved
Printed in USA
Publication No. I. L. 29-885D / TBG000639
Part No. 7829C35H04
August 2011