

DESIGN UNITS: METRIC (mm)
UNLESS OTHERWISE SPECIFIED [INCHES]

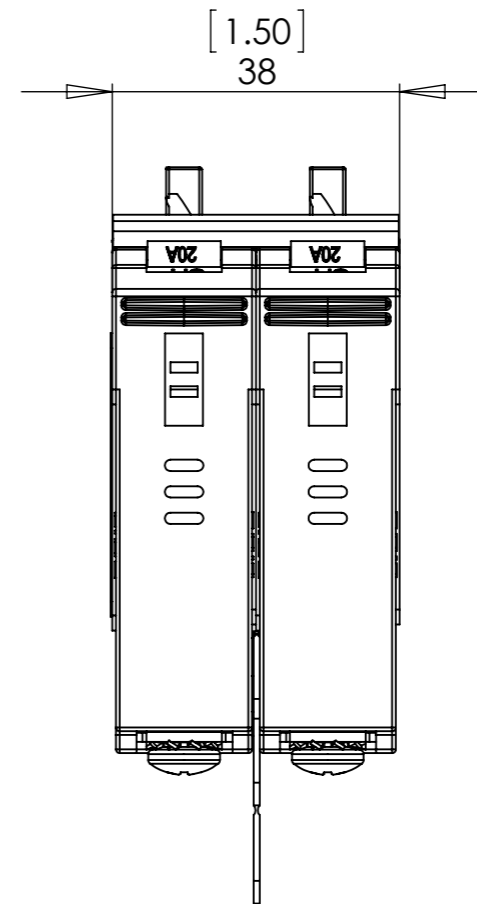

THIRD ANGLE PROJECTION

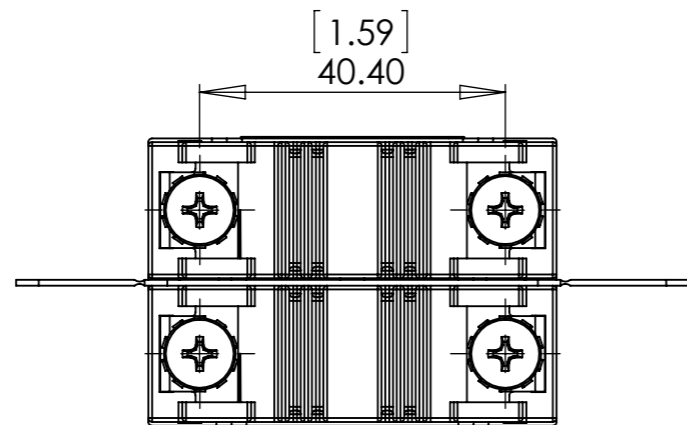
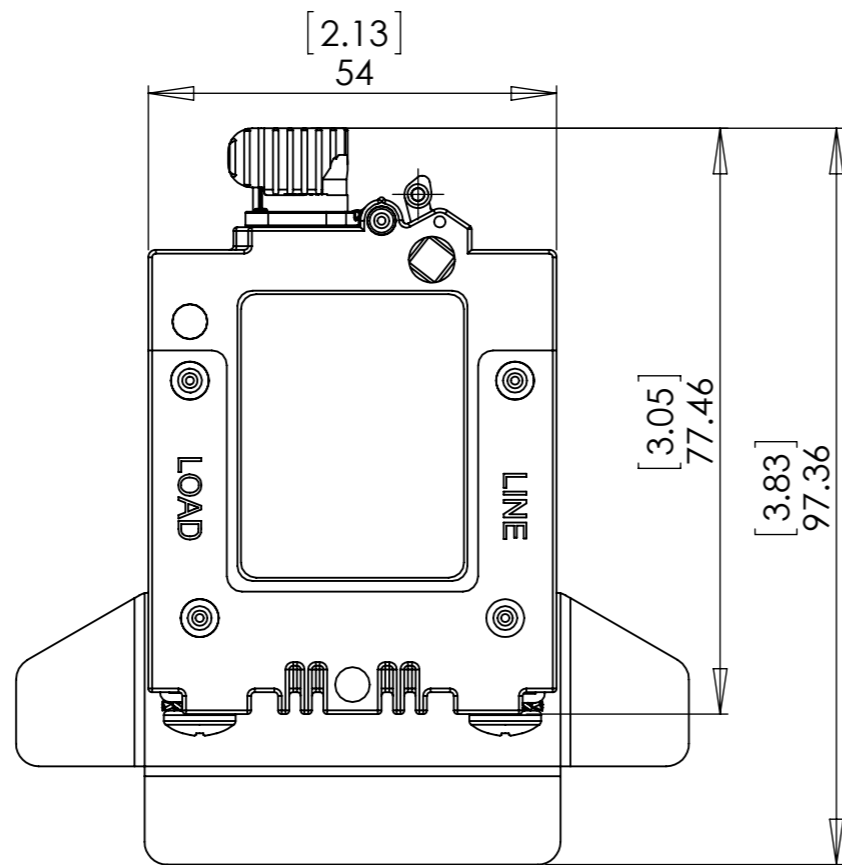
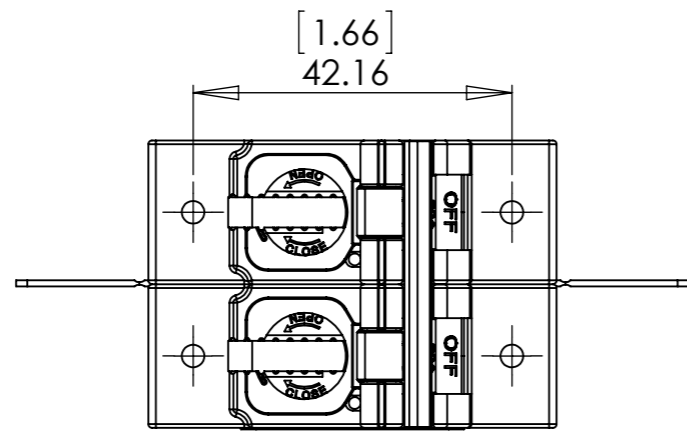

Bussmann
by **E.T.N.**

St. Louis MO 63178

TITLE:

CCPLP -2-20G-S

SCALE:
1:1

SIZE:
A3

SHEET:
1 OF 1