

Eaton Differentials Owner's Manual



EATON

Powering Business Worldwide

Eaton Differentials Owner's Manual

Table of Contents

Preface.....	2
History.....	2
Warranty.....	4
Detroit Locker / NoSPIN.....	6
Detroit Truetrac.....	10
Eaton Posi.....	14
Eaton ELocker.....	18
Safety.....	23
Lubrication.....	26
Installation.....	28

Preface

Eaton has been a leading manufacturer of premium quality OEM, military and aftermarket traction enhancing and performance differentials for more than 80 years. Each step in our manufacturing process, from design to final assembly and inspection, reflects the highest industry quality and engineering standards. This manual is intended to help provide safe and trouble-free operation for the life of the product.

General Information

Telephone: 800-328-3850
Website: eatonperformance.com
Office Hours: 7:30 a.m. - 5:30 p.m. (ET) Mon. - Thu.
7:30 a.m. - 4:30 p.m. (ET) Fri.

Automotive Focused History of Eaton

- 1900- Viggo Torbensen develops and patents the first gear-driven rear truck axle
- 1911- Torbensen teams up with Joseph Eaton, an aspiring young businessman, to found Torbensen Gear and Axle
- 1911- Torbensen Gear and Axle manufactures just seven axles in its first year, using specialized tools to handcraft them from raw materials
- 1915- Torbensen Gear and Axle Company moves its growing operations from Newark, NJ to Cleveland, OH, which was becoming an automobile and truck manufacturing center
- 1916- US highways improve and Torbensen produces 10,068 truck axles
- 1917- Republic Motor Truck (largest US truck manufacturer at the time) acquires Torbensen Axle
- 1919- Torbensen Axle produces 70,000 axles annually
- 1919- J.O. Eaton sells off his stock in Republic Motor Truck and forms Eaton Axle Company, manufacturing conventional and internal gear truck axles
- 1920- Eaton Axle Company builds a new \$1 million plant in Cleveland, OH

- 1922- Eaton Axle Company buys back the Torbensen Axle division of Republic Motor Truck
- 1923- Torbensen Axle purchases two spring manufacturing plants
- 1923- Torbensen Axle officially becomes Eaton Axle and Spring, manufacturing was approaching 150,000 axles annually and 10,000 springs daily
- 1926- Eaton Axle and Spring launches production of Ruckstell Axles for Ford Motor Company passenger cars and trucks, including the Model T
- 1928- Eaton acquires Perfection Heater (first manufacturer of automotive heaters) and Easy-on Cap (manufacturer of fuel and radiator caps)
- 1930- Eaton acquires Wilcox-Rich, a leading manufacturer of sodium-cooled aircraft engine valves
- 1940- The newly renamed Eaton Manufacturing Company begins production of components for Cadillac's new Hydra-Matic and Chrysler's new Fluid Drive transmissions
- 1952- Eaton develops the first affordable automotive air system
- 1958- Eaton acquires Fuller Manufacturing, producers of medium and heavy-duty transmissions
- 1963- Eaton acquires Dole Valve Company, developer of the automotive engine thermostat
- 1967- Eaton develops one of the first passenger car air bag systems
- 1970- Eaton acquires the Char-Lynn Company, manufacturer of hydraulic motors for agricultural and industrial equipment
- 1978- Eaton acquires Cutler-Hammer and enters the electronic controls market
- 1997- Eaton effectively trades its axle and brake business to Dana in exchange for their Spicer Clutch Division, manufacturer of medium and heavy-duty truck clutches
- 1999- Eaton acquires Aeroquip-Vickers, entering the fluid power business
- 2002- Eaton acquires Boston Weatherhead from Dana Corporation, manufacturer of hydraulic metal fittings and hoses
- 2005- Eaton acquires Tractech Inc, manufacturer of performance, agricultural, industrial, and military vehicle powertrain differentials
- 2016- Launches direct acting ELocker
- 2017- First eLSD differential OEM (IntelliTrac™) in Ford Navigator and Expedition

Differential Limited Warranty and Information

Eaton expressly warrants each Eaton differential part to be free from defects in materials and workmanship for a period of 12 months from the date of initial retail purchase when used on private passenger cars and light trucks under normal operating conditions.

Eaton's obligation under this warranty is limited to replacement of the worn-out or defective product in accordance with this warranty. Cost of removal and installation are not included, and any incidental and consequential damages are excluded under this warranty, regardless of when the failure occurs. This warranty has no cash value. This warranty does not apply to products that have been modified, improperly applied or installed on vehicles used for commercial or racing purposes.

To make a claim under this warranty, return the worn-out or defective product with the dated original receipt to the dealer or retailer from whom it was purchased for verification and exchange under this warranty.

This warranty gives you specific legal rights, and you may also have other rights, which vary from state to state. Any implied warranties you may have under state law are limited to the same duration as this warranty. Some states do not allow limitations on how long an implied warranty lasts or do not allow the exclusion or limitation of incidental or consequential damages, so the above limitations and exclusion may not apply to you.

Eaton may contact warranty-serviced consumers to conduct customer satisfaction surveys relating to product and warranty service. Survey activity will provide valuable feedback and help measure the level of consumer satisfaction in different markets.

Qualifying Aftermarket Products

- Eaton Posi
- Eaton ELocker
- Detroit Locker
- Detroit TrueTrac
- NoSPIN

For product questions, please contact Eaton Performance customer service at **800-328-3850**. Hours are: Mon. – Thurs. 7:30 a.m. – 5:30 p.m. (ET), Fri. 7:30 a.m. – 4:30 p.m. (ET). For FAQs and additional warranty information, see www.eatonperformance.com

Differential Application Guide



Powering Business Worldwide

	Selectable locking	Automatic locking	High bias limited-slip	Medium bias limited-slip
Detroit Locker	<input type="checkbox"/>	<input checked="" type="checkbox"/>	<input type="checkbox"/>	<input type="checkbox"/>
Detroit Truetrac	<input type="checkbox"/>	<input type="checkbox"/>	<input checked="" type="checkbox"/>	<input type="checkbox"/>
Eaton ELocker	<input checked="" type="checkbox"/>	<input type="checkbox"/>	<input type="checkbox"/>	<input type="checkbox"/>
Eaton Posi	<input type="checkbox"/>	<input type="checkbox"/>	<input type="checkbox"/>	<input checked="" type="checkbox"/>
NoSPIN	<input type="checkbox"/>	<input checked="" type="checkbox"/>	<input type="checkbox"/>	<input type="checkbox"/>

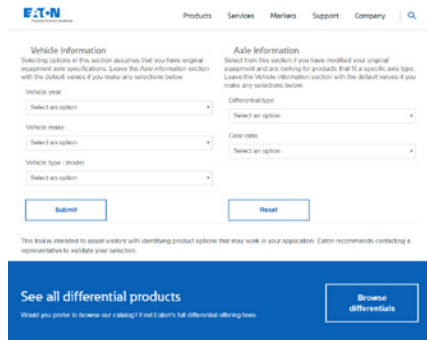

Use our interactive differential selector tool, or download a PDF differential application guide, at EatonPerformance.com

Detroit Locker / NoSPIN

Heavy-duty automatic locking differential

NOTES

187C145A, 187C146A, 187C147A 4.56, 4.88 and 5.13 gear ratios require some modification for install.

187S196A Designed to fit axles cut with 45-degree pressure angles.

187S196A Custom housing with 3.25" bearing bore.

187C148A, 187C149A, 187C150A All Eaton differentials made for General Motors 8.5" and 8.6" axles require special bearings. For axles with small bearing bores (race O.D. or 2.89"), usually found on vehicles prior to 1999, bearing LM102949 and race LM102911 are required. For axles with large bearing bores (race O.D. of 3.06"), usually found on vehicles from 1999 to present, bearing LM603049 and race LM603012 are required.

250SL195A 2007 and newer vehicles require model years 2003-2006 ring and pinion.

225SL58A, 225SL58B, 225SL58C, 225SL58D For Dana 70/70HD, 35 spline applications: If differential case is one-piece use Detroit Locker #225SL58 (A,B,C,D); If differential case is two-pieces use Detroit Locker #225S18.

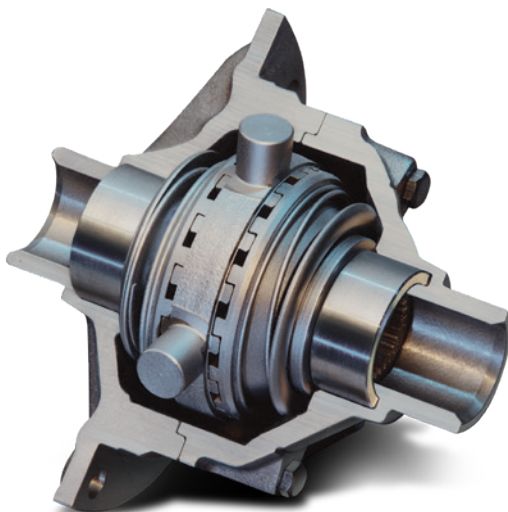

Eaton's Detroit Locker, also known as a NoSPIN, is a fully automatic, positive-locking, traction differential. NoSPIN products are designed to replace the internal gear set of the factory or open differential, while Detroit Locker models are designed to replace the entire differential. Both the NoSPIN and Detroit Locker operate identically as a locking differential, and are known around the world for premium performance, dependable operation and unmatched durability. This differential is the culmination of more than 80 years of engineering for both original equipment and performance upgrade applications. NoSPIN is a proven performer for light, medium and heavy-duty trucks, off-highway, agricultural, forestry, military, specialty-equipment vehicles, performance off-road, circle track racing and drag racing.

The Detroit Locker / NoSPIN maximizes traction by delivering 100 percent of the torque and power to both drive wheels. It is engineered to keep both wheels in a constant drive mode, yet has the ability to automatically "unlock" to permit necessary wheel speed differentiation when negotiating turns, maintaining 100 percent of the powertrain torque to the driving wheel. The Detroit Locker / NoSPIN is maintenance free and doesn't require special lubricants or service adjustments. Conventional differentials allow vehicles to get stuck when they lose traction on one side. This superior product continues to drive your vehicle even if one of the wheels is suspended in the air, or in the event of axle shaft failure.

Benefits

- Provides a fully locked axle that automatically unlocks when wheel speed differentiation is necessary
- Maximum torque delivery to the high traction wheel
- Maintenance free - requires no special lubrication or friction modifiers
- Extremely strong and durable unit
- 100 percent automatic locking action - even with one wheel off the ground
- Torque delivery capacity of a spool with added ability to differentiate wheels in a turn

Technical Specifications

- Most commonly found in rear drive axle applications; however, the Detroit Locker and NoSPIN differentials also have select front, and transfer case applications
- Compatible with most advanced anti-lock brake systems
- Speed-sensitive automatic locking differential that powers both drive wheels, yet automatically permits wheel speed differentiation as needed
- Performance characteristics vary by application such as the M-series, N-series, R-series and race lockers
- Available for c-clip axle designs
- Detroit Locker models include the differential case
- NoSPIN models do not include the differential case

Applications

- Construction
- Military
- Agriculture
- Forestry
- Mining
- Off-road performance
- Competition "monster" trucks
- Drag racing
- Stock car racing



NOTES

162SL60A, 162SL60B,
187SL16C, 187SL16D
Applies to disconnect only.

162C66A Bearing
LM102949 and race
LM102911 and unique
shims are required.

For Dana 61-1 full float,
1.31" axle shaft diameter,
30-spline axles: 3.31
& dn ratios use Detroit
Locker #225SL19B.

225SL56A, 225SL58C,
225SL58D Full float only.

225SL105A, 225SL131A
Will fit OE 3.73 thin
gear sets.

225S10 differential replaces
the conventional differential
internals used in certain
1973- present GM axles.
If it is to be installed
in a GM axle equipped
with an optional Eaton
differential, it will also be
necessary to purchase a
new gear support case
assembly, GM #6258336
or #6258340, depending
upon gear ratio.

187SL173A Axle serial
numbers 49L11363C or
57L05188B and later.

187SL174A Axle serial
numbers and later: Range
Rover- suffix H, 88/109 4
cyl. ¾ ton- suffix H, 109
V8/1 ton- suffix D.

187SL173A Axle serial
numbers 35S18135C or
37S08651B and later.

187SL174A Axle serial
numbers and later: Range
Rover- suffix F, 88- suffix
G, 109 V8/1 ton- (Salisbury
standard), 109 4 cyl. ¾ ton-
(Salisbury optional).

187SL61B 32010X bearing
allows 913A610 in place
of 913A611.

Detroit Locker / NoSPIN Function Check

NOTES

187SL16C, 187SL16D,
225SL29A For use of non-
thick ring gears.

Some applications may
require modification of the
ring gear bolt hole diameter
for proper assembly.

PLEASE READ COMPLETELY THROUGH AND UNDERSTAND THE INSTRUCTIONS BEFORE STARTING

Test Set-up

With the engine turned off and wheels chocked, raise Detroit Locker / NoSPIN equipped driving axle(s) until all tires are out of contact with any surface. Check both hand and foot brakes for possible drag caused by improper adjustment. Place the transmission in gear or park so that the **DRIVESHAFT IS LOCKED AND DOES NOT ROTATE.**

Step One

With two people, one on the left wheel and one on the right wheel, rotate the top of both wheels rearward, until both wheels lock and will not rotate farther in the rearward direction.

Step Two

With the top of the left wheel securely held in the rearward direction, rotate the right wheel slowly forward. A faint indexing or clicking sound should be heard as the Detroit Locker / NoSPIN disengages the right wheel. The right wheel should continue to turn freely in the forward direction.

Step Three

With the right wheel slowly rotating forward, the left wheel should be rotated forward to match the speed of the right wheel. This should re-engage both wheels and you should not be able to turn either wheel more than one additional revolution in this direction.

Step Four

Again, rotate the top of both wheels rearward, as far as possible to lock both wheels.

Step Five

With the top of the right wheel securely held in the rearward direction, rotate the left wheel slowly forward. A faint indexing or clicking sound should be heard as the Detroit Locker / NoSPIN disengages the left wheel. The left wheel should continue to turn freely in the forward direction.

Step Six

With the left wheel slowly rotating forward, the right wheel should be rotated to match the speed of the left wheel. This should re-engage both wheels and you should not be able to turn either wheel more than one

additional revolution in this direction. Repeat steps 1-6 reversing the direction of rotation in which the wheels are held and rotated. This tests for proper function in the opposite drive direction. If the above steps are completed successfully and rotating wheels disengage easily by hand, rotate freely and evenly, lock both wheels when required, and produce a faint indexing or clicking sound, then the Detroit Locker / NoSPIN is properly installed and is functioning correctly. **IF EITHER WHEEL DOES NOT ROTATE FREELY IN EITHER DIRECTION** or does not lock both wheels as required, re-check the installation of the Detroit Locker / NoSPIN in the axle (excluding the CTR series; the CTR series is designed exclusively for single direction, oval-track use only).

NOTES

Three exceptions are the R-series, N-series and Race series. The R-series will re-engage when the free wheel is rotated in the reverse direction. Reverse operation is normal. The N-series and Race lockers do not have holdout rings. The Detroit Locker/ NoSPIN design very aggressively re-engages if the hold-out rings are not present.

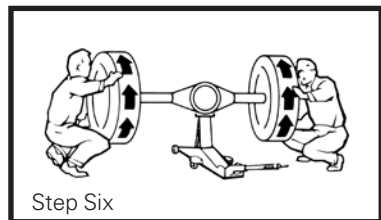
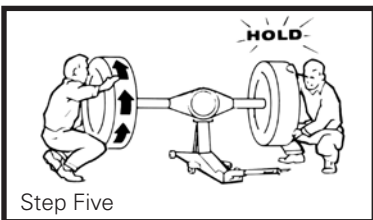
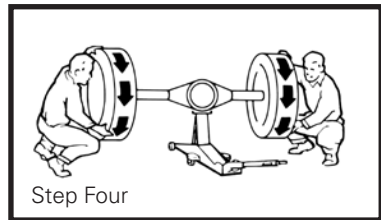
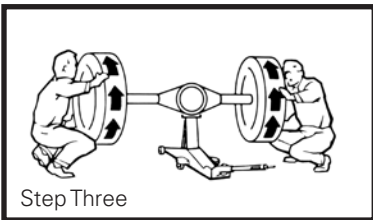
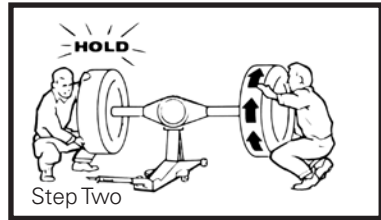
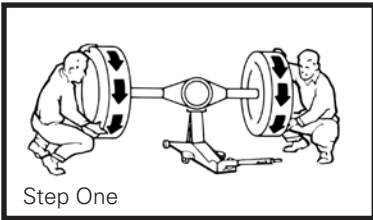

Detroit Truetrac

High performance limited-slip differential

NOTES

914A575, 914A576, 914A583 Detroit Truetrac, 33-spline units for this application are designed to fit axles cut with 45-degree pressure angles.

912A616 Bearing LM102949 and race LM102910 are required.

913A555, 914A575, 914A576 Designed to fit axles cut with 45-degree pressure angles.

912A556, 912A557, 913A481 All Eaton differentials made for General Motors 8.5" and 8.6" axles require special bearings. For axles with small bearing bores (race O.D. or 2.89"), usually found on vehicles prior to 1999, bearing LM102949 and race LM102911 are required. For axles with large bearing bores (race O.D. of 3.06"), usually found on vehicles from 1999 to present, bearing LM603049 and race LM603012 are required.

914A643, 915A568 2007 and newer vehicles require model years 2003-2006 ring and pinion.

912A584, 912A585, 913A591, 913A592 Applies to disconnect only.

915A450, 916A427 Will fit OE 3.73 thin gear sets.

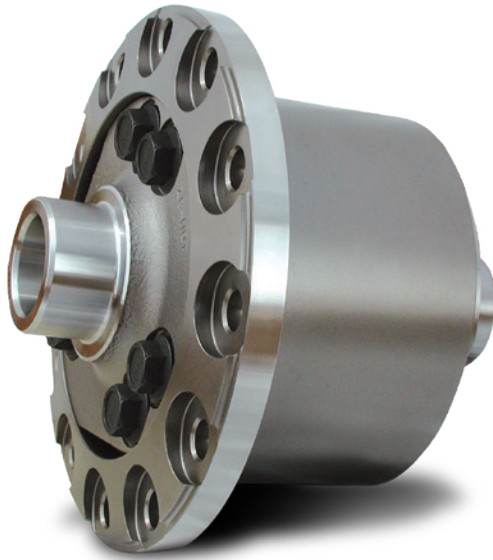

The Detroit Truetrac is the leading helical gear-type limited-slip differential in the industry. Eaton has a proven track record of producing the most effective and dependable traction differentials in the world. Truetrac's patented design of parallel axis, planetary helical gears, provides a smooth and quiet automatic division of torque. Power transfer is so smooth, it is typically unnoticed by the driver, even in front wheel drive axles. Although Truetracs offer the highest bias ratio in the forward direction, they also exhibit a slightly reduced bias ratio in the reverse direction or during engine braking. The bias performance of the Truetrac complements and enhances brake-based traction control systems. Under normal driving conditions, Truetrac performs like an open differential. On wet, muddy, icy or loose terrain, imbalanced gear forces automatically transfer power to the wheel with the highest traction. The Truetrac limited-slip differential responds instantly to torque feedback, providing needed traction, anytime, at any speed. Truetrac differentials are engineered to work efficiently in front and rear axles and transfer cases. Designs exist for C-clip, full-float, semi-float, and snap-ring style axle configurations. Proven design, low cost and effective performance all make the Truetrac limited-slip differential the ideal choice for a wide variety of vehicle applications, including road racing, off-road competition, emergency vehicles, motor homes and commercial trucks.

Detroit Truetrac Function Check

Manual test

Step One

With the engine turned off and wheels chocked, raise Truetrac-equipped driving axle(s) until all tires are out of contact with any surface. Check both hand and foot brakes for possible drag caused by improper adjustment. Place the transmission in gear or park so that the **DRIVE-SHAFT IS LOCKED AND DOES NOT ROTATE.**

Step Two

While turning one wheel, the other should rotate in the opposite direction. Units with preload will have greater resistance to turning. Units without preload will appear to have a higher internal gear lash (tires will feel more loose during initial rotation). However all units actually have similar lash values.

Step Three

Verify correct operations during road test. Use the in-vehicle test shown on the next page.

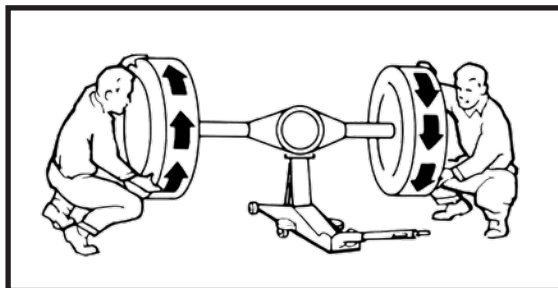

Check in both directions to ensure the Truetrac is operating properly.

NOTES

* For Truetrac models built with pre-load, the rotation will be restricted (depending on model).

912A407 Axle serial numbers 49L11363C or 57L05188B and later.

910A416 Axle serial numbers and later: Range Rover- suffix H, 88/109 4 cyl. ¾ ton- suffix H, 109 V8/1 ton- suffix D.

912A383 Axle serial numbers 35S18135C or 37S08651B and later.

910A400 Axle serial numbers and later: Range Rover- suffix F, 88- suffix G, 109 V8/1 ton- (Salisbury standard), 109 4 cyl. ¾ ton- (Salisbury optional).

913A582 All vehicles equipped with OE Electric Locker require modification.

911A342 will not fit clamshell housing.

913A610 32010X bearing allows 913A610 in place of 913A611.

911A445 Will not fit selector disconnect "shift on the fly."

911A445, 913A609 xxvi "Small" hub bearing diameter 45 mm.

911A342 "Large" hub bearing diameter 50 mm- uses Toyota bearing #90368-50006.

913A589, 913A90, 915A388, 915A550 For use of non-thick ring gears.

Detroit Truetrac Function Check

Vehicle test



Step One

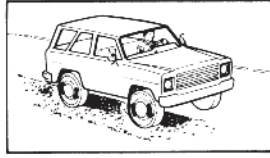

Step Two

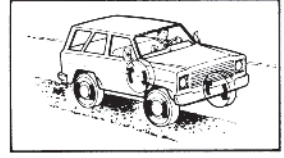

Step Three

Step One

Pull the vehicle off to the side of a paved or concrete area with the left wheels on a hard, dry surface, and the right wheels on loose gravel, dirt, etc. - any safe place where traction surfaces (ground friction coefficients) are different for the left and right wheels.

Step Two

As you accelerate, the wheel with the least traction (right wheel) should spin momentarily.

Step Three

The spinning wheel should then slow down and synchronize with the opposite wheel as the Truetrac differential transfers power from the low traction wheel to the high traction wheel.

CAUTION: PERFORM THIS TEST IN AN ISOLATED AREA WHERE THERE IS NO POSSIBLE CHANCE OF INTERFERING WITH OTHER VEHICLES OR PEOPLE.

Eaton Posi

High performance limited-slip differential

NOTES

19557-010, 19559-010 All Eaton differentials made for General Motors 8.5" and 8.6" axles require special bearings. For axles with small bearing bores (race O.D. of 2.89"), usually found on vehicles prior to 1999, bearing LM102949 and race LM102911 are required. For axles with large bearing bores (race O.D. of 3.06"), usually found on vehicles from 1999 to present, bearing LM603049 and race LM603012 are required.

19694-010 Full float only.

19557-010, 19559-010 Manual locking hubs recommended.

19610-010 Requires ring gear bolt: GM part #12479387.

19510-010, 19512-010 Includes 800# preload springs.

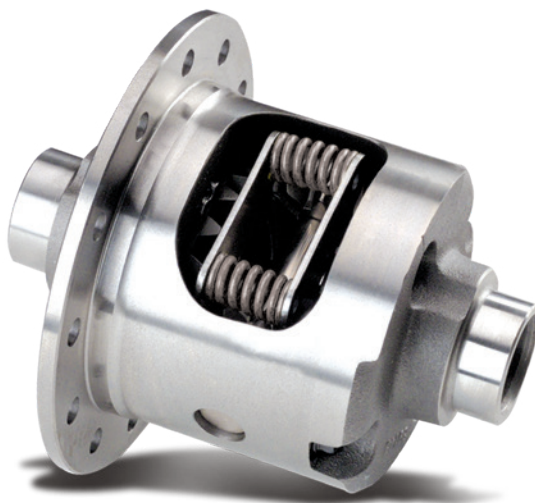

Originally released for General Motors' Chevrolet Truck Division in 1959, the Eaton Posi limited-slip differential (then "Eaton Trac-Aide" and branded by GM as "Positraction") is designed to provide significantly enhanced traction capability for a wide variety of vehicles. The original units were strictly designed for enhanced traction. In the fall of 1959, following the results of extensive testing by GM's Cadillac Motor Division, the design was revised to provide a higher and more consistent bias ratio with reduced "chatter." Since those early days, many improvements and innovations have resulted in the Eaton Posi becoming the industry leader for high performance clutch-style limited-slip differentials.

In addition to 60 years of product engineering and testing, Eaton proprietary clutch materials, industry leading gear strength, and advanced manufacturing processes have allowed the Eaton Posi to continue to lead the way in affordable performance enhancement. All Eaton Posi designs are subjected to rigorous validation tests at our Michigan-based 700 acre proving grounds and dynamometer facilities for validating strength, durability, performance, quality and torque capacity.

The Eaton Posi has two distinct characteristics. For low-torque conditions, the preload springs apply an initial resistance by energizing the clamp load of the clutch packs. The product design allows for different spring

loads to be swapped into the differential to increase or decrease this initial bias ratio/torque transfer capability. Spring loads are often used to “tune” the handling dynamics of performance vehicles. The spring cage design also ensures this load is perfectly balanced between sides and evenly distributed to the clutch surfaces. Once additional torque is applied, the gear tooth design becomes the dominant force generator to the clutch packs. The torque is used to separate the side gears from the pinion gears, providing increasing resistance in the clutches. This resistance does two things: slows the low-traction wheel and diverts power to the wheel most able to put the power effectively to the ground.

Benefits

- Proprietary high-performance clutch material
- High-torque capacity
- Simple design
- Lowest noise plate-style LSD
- Highest durability plate-style LSD
- Predictable performance
- Safer than a spool in drag racing applications

Technical Specifications

- Superior rebuildable design
- Exclusively developed Eaton proprietary friction disc material for maximum grip, highest durability, and least LSD chatter
- Automatic limited-slip functionality
- Adjustable preload biasing

Applications

- Street rod
- Muscle car
- Drag racing
- Road racing
- Towing
- Recreational vehicles
- Light duty off-road

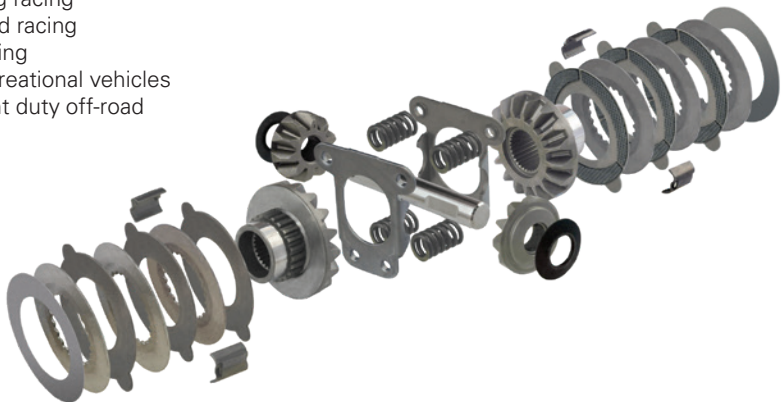

Posi Function Check

Manual test

Step One

With the engine turned off and wheels chocked, raise Posi-equipped driving axle(s) until all tires are out of contact with any surface. Check both hand and foot brakes for possible drag caused by improper adjustment. Place the transmission in gear or park so that the **DRIVE-SHAFT IS LOCKED AND DOES NOT ROTATE.**

Step Two

While turning one wheel, the other should rotate in the same direction. Units with preload will have greater resistance to turning and higher breakaway torque.

Step Three

Verify correct operations during road test. Use the in-vehicle test shown on the next page.

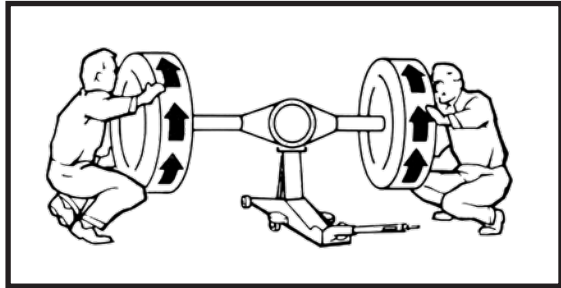

Check in both directions to verify that the Posi differential is operating properly.

Posi Function Check

Vehicle test

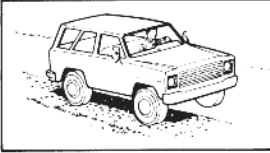

Step One



Step Two

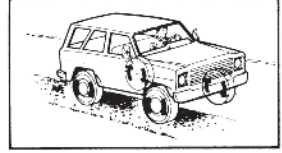

Step Three

Step One

Pull the vehicle off to the side of a paved or concrete area with the left wheels on a hard, dry surface, and the right wheels on loose gravel, dirt, etc. - any safe place where traction surfaces (ground friction coefficients) are different for the left and right wheels.

Step Two

As you accelerate, the wheel with the least traction (right wheel) should spin momentarily.

Step Three

The spinning wheel should then slow down and synchronize with the opposite wheel as the Posi differential transfers power from the low traction wheel to the high traction wheel.

CAUTION: PERFORM THIS TEST IN AN ISOLATED AREA WHERE THERE IS NO POSSIBLE CHANCE OF INTERFERING WITH OTHER VEHICLES OR PEOPLE.

Eaton ELocker

Selectable locking differential

NOTES

19659-010 All Eaton differentials made for General Motors 8.5" and 8.6" axles require special bearings. For axles with small bearing bores (race O.D. or 2.89"), usually found on vehicles prior to 1999, bearing LM102949 and race LM102911 are required. For axles with large bearing bores (race O.D. of 3.06"), usually found on vehicles from 1999 to present, bearing LM603049 and race LM603012 are required.

19817-020, 19818-020, 19819-020, 19821-020, 19822-020 Bearing LM102949 and race LM102911 and unique shims are required.

CAUTION

Vehicle steering may be impaired while driving with differential locked

- Do not operate a vehicle with a locked differential above speeds of 20mph
- Disengage a front axle installed Eaton ELocker immediately once free of low traction conditions
- Use caution while accelerating with differential locked on low traction surfaces

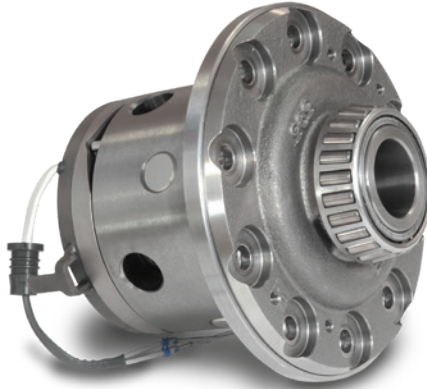

This highly engineered unit allows for maximum driveline flexibility. Users can switch from a fully-open to 100 percent-locked axle at the touch of a button. Several designs of ELocker differentials are in production, with the 4-pinion ELocker4 models providing industry leading torque capacity for highly demanding applications.

Users operate the ELocker with the flip of a dash switch. When in the "off" position the unit operates as a fully-open differential. If activated to the "on" position, an electronically-controlled mechanism locks the internal differential gear set to the differential case providing 100 percent axle lock.

The Eaton ELocker is designed for a variety of uses. Towing, off-road, and rock crawling, all benefit by installing an ELocker. Its smooth engagement and validated strength make it an ideal solution to improve traction and maneuverability. Units are available for front and rear-axle installation.

Benefits

- Provides full axle lock upon driver command
- Maintenance free, requires no lube additives
- Enhanced towing and off-road performance
- Electronic lock activated by dash-mounted switch
- Compatible with most advanced braking systems

Applications

- Recreational off-road vehicles
- Snow plows
- Trucks
- Light / Medium-duty trucks
- Military

Technical Specifications

- Maximum current draw is under 10 amps, with normal current draw between 5 and 8 amps
- Electric system consists of a switch, relay, fuse and diode (all included in a provided harness)
- Maximum delta wheel speed 50 rpm for engagement or maximum vehicle speed of 5 mph for engagement
- Assembly kit includes complete wiring harness and switch

ELocker – Pin type



ELocker 4 – Collar Style



ELocker – Direct Acting

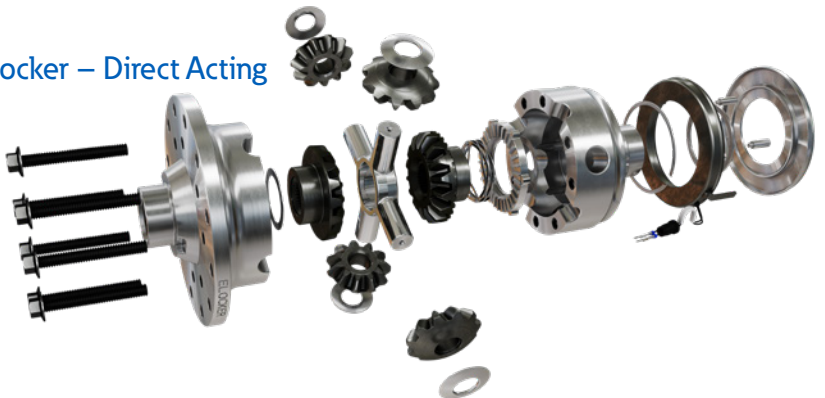

⚠ CAUTION

Improper use of a locked differential may damage driveline components

- Only engage the Eaton ELocker while vehicle speed is under 5mph with limited or no wheel slip occurring
- Continuous usage of a locked differential on high traction surfaces will strain driveline components
- Reduce driveline torque while disengaging the Eaton ELocker and allow locking components to release freely

Eaton ELocker Function Check

Visual inspection: Salisbury style axles

Step One

Lift one wheel of the axle fitted with the ELocker using proper and safe methods ensuring that the wheel still in contact with the ground is properly chocked to prevent any vehicle movement.

Step Two

Remove the axle inspection cover (drain lube if filled).

Step Three

Place the driveline into “Neutral” and confirm the lifted wheel will rotate in either direction.

Step Four

Switch on the ELocker. If the installation requires the ignition to be switched on, **ENSURE THE ENGINE DOES NOT START.**

Collar style ELocker designs

Collar-style ELockers are easily identified by the three dual ramp surfaces of the ramp plate on the barrel end of the differential case. Rotate the suspended wheel until the differential engages. Engagement should occur within a few degrees of rotation. Engagement will be confirmed with the differential locking the suspended wheel to the wheel remaining on the ground. Further rotation will not occur. The movement of the pushrods can be observed as they slide up the ramps during the engagement operation. The power switch should have a constant-on light indicating power is being sent to the relay.

Pin-style ELocker designs

Pin-style ELockers are identified by the actuator on the ring gear end of the differential case. Rotate the suspended wheel until the differential engages. Engagement should occur within a few degrees of rotation and will be shown by the differential locking the suspended wheel with the wheel remaining on the ground. Further rotation will not occur. The engagement of the locking pins may be heard just as the unit locks. The power switch should have a constant-on light, indicating power is being sent to the relay. Pin-style ELockers are identifiable by the absence of the barrel-end ramp plate. The motion mechanism is contained within the differential case. All pin-style models are 2-pinion designs.

Eaton ELocker Function Check (continued)

Direct-acting style ELocker designs

Direct-acting style ELockers are easily identified by the solid ring on the barrel-end of the differential case. Upon switching on the ELocker, the unit will activate immediately. Lacking rotation of the axle components, it is possible for the ELocker to require a slight motion of the suspended wheel to engage the locking mechanism. In service, the engagement of the locking mechanism should be transparent to the operator. The power switch should have a constant-on light, indicating engagement of the lock mechanism. If the light in the switch does not come on while the switch is in the "ON" position it could mean an electrical fault in the switch circuit. Confirm the red wire is connected to an IGN fuse location, the black wire to a clean ground, the vehicle ignition is in the "ON" position, and switch circuit fuse is not blown.

Dynamic inspection: all styles of axles

Step One

Engage the ELocker on a hard, reduced traction surface such as packed dirt, but not pavement or asphalt.

Step Two

Perform this test at a slow speed.

Front axle installation: The axle should provide steering feedback indicating tire scrub. This is proof that the front axle is locked. Rear axle: The tires should scrub/drag as you turn a corner. This is proof that the rear axle is locked.



Eaton ELocker Differential Operation

Differential engagement should occur before an obstacle is encountered. If you feel that you are in a situation that may require extra traction, it is recommended to engage the Eaton ELocker differential in anticipation.

Differential engagement should be deactivated after the difficult terrain is overcome. It is not recommended to deactivate the Eaton ELocker differential while the drivetrain has loaded or torque bound, such as under cornering. When the drivetrain is heavily loaded, the Eaton ELocker differential may not immediately disengage, temporarily resulting in a locked differential until the torque is reduced.

Differential engagement should be used on low traction surfaces, such as those encountered in off-highway use. Continuous operation of a locked differential on high traction surfaces can produce excessive strain on drivetrain and chassis components while cornering in the vehicle. Caution should be taken when operating locked differentials on slippery terrain, such as icy surfaces. High speeds on slippery surfaces with a differential locked can result in undesirable vehicle behavior or loss of vehicle control. Always operate the vehicle with caution and reduced speed in such conditions.





READ ALL NOTES COMPLETELY BEFORE STARTING INSTALLATION

PRIOR TO INSTALLATION!

- Read this entire manual prior to removing the differential from the box
- See any additional supplements for important information regarding your new Eaton differential
- Verify the unit is correct for your application. Primary items to note are flange position, bearing shoulder diameters, span, axle spline count and size
- Consult a vehicle or axle service manual for specific directions for installation of the product. This manual does not include specific instructions per application

Eaton Differentials Requiring Non-Factory Bearings:

Some applications may require non-OEM bearings. See box, catalog, www.EatonPerformance.com, or call the Eaton Performance Customer Service hotline at (800)328-3850.

For your safety while servicing an axle:

Ensure that the vehicle is parked on a level, hard, flat surface such as a concrete floor or driveway. If the vehicle is equipped with an automatic transmission, place the car in park and apply the parking brake. If it has a manual transmission, shift the vehicle into reverse and apply the parking brake.

Before performing any service on the vehicle, block the tires by placing a suitable object on both sides of at least one wheel to reduce the chance of rolling.

In lieu of a vehicle lift, a jack should be used to lift the vehicle. Jack failure is a common occurrence. Jacks are lifting tools, not a vehicle support.

Safety (continued)

NOTES

Eaton promotes environmental consciousness. Please catch all fluids drained while servicing the vehicle. Recycling of the fluids recovered during service will greatly benefit the environment and help protect your family and community. Please recycle.

Never insert any part of your body under the vehicle without first bracing the vehicle on jack stands. These should be securely positioned in the locations recommended by the manufacturer as “jack-points,” as listed in the vehicle’s owner’s manual or service manual. **FAILURE TO CORRECTLY POSITION THE JACK OR JACK STANDS CAN EASILY CAUSE SEVERE DAMAGE TO A WIDE VARIETY OF COMPONENTS.** When possible, jack stands should be placed under the axle or frame rails on beam axle or full-frame vehicles. **DO NOT** use items such as concrete blocks, bricks, lumber, tires, or other objects for bracing. Suitable jack stands are widely available for minimal cost. Make sure the stands are rated for the weight of the vehicle being serviced.

After the vehicle is properly braced on the jack stands, it is advisable to “wiggle” it to make certain all bracing is secure. Also re-check that all four corners of each jack stand are firmly seated on the ground. They can “walk” during jacking and installation of subsequent jack stands. Never run the engine while the wheels are off the ground.

IF WORKING WITH THE VEHICLE ELECTRICAL SYSTEM, SUCH AS AN ELOCKER INSTALLATION, DISCONNECT THE BATTERY.

When using any hammers, chisels, or power tools, personal-protection equipment such as safety glasses, gloves, and ear protection must be worn to protect the installer.

Verifying Clearance

- While Eaton designs every differential to be a direct fit into every application, we still advise the installer to verify the clearances around the differential
- Although a standard model of differential may fit a particular application, years of revisions to OEM castings and aftermarket axle housing options can create interferences not originally present in the axle's design
- Proper method for checking requires the differential assembly to be rotated in the fully assembled axle. Pay close attention to ring gear bolt heads and areas near the bearings
- Also check clearance to the axle cover – especially with non-original covers

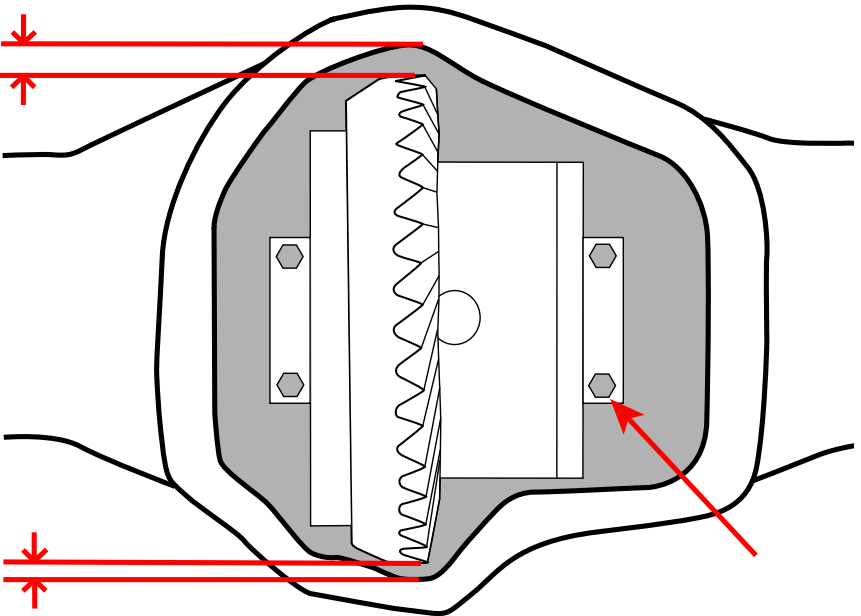

Lubrication Specifications

Detroit Locker / NoSPIN



- Most gear oils are sufficient: a quality, petroleum-mineral based oil is recommended
- Synthetic oils and friction modifiers can also be used, but are not necessary

Detroit Truetrac



- A quality, petroleum-mineral based, GL5 rated 80w-90 gear oil should be used
- Synthetic oils are not recommended for Truetrac applications. While some customers have found that synthetic oils work well in this application, Eaton has not confirmed under test conditions that **all** synthetic oils are compatible with Eaton Truetrac applications
- Friction modifiers should not be used because they will decrease performance (reduce differential bias)

Eaton Posi



- A quality, petroleum-mineral based, GL5 rated 80w-90 gear oil should be used
- It is necessary to add a four-ounce bottle of friction modifier for optimum performance (if friction modifier has not already been added to the petroleum-mineral based gear oil that the customer selects)
- While some customers have found that synthetic oil works well in this application, Eaton has not confirmed under test conditions that all synthetic oils (with added friction modifier) are compatible with Eaton Posi applications

Lubrication Specifications (continued)

Eaton ELocker



- Most gear oils are sufficient: a quality, petroleum-mineral based oil is recommended
- Synthetic oils and friction modifiers can also be used, but are not necessary
- In cold weather conditions, a lower viscosity gear oil (equivalent to API GL-5 75W-90) is recommended

LUBRICATION

Eaton recommends changing the lubricating fluid at or before the axle /vehicle manufacturer's suggested interval. At a minimum, conventional gear lube should be changed every 50,000 miles or 1,500 hours (agricultural/military use), and synthetic lube at 75,000 miles or 3,000 hours. For highly abusive applications or where water/mud/slurry submersion occurs, more frequent lubrication changes will greatly increase the life of all axle components.

General Installation Guide

CAUTION

IT IS RECOMMENDED THAT SAFETY GLASSES BE WORN WHEN INSTALLING THE PRODUCT.

NOTE

WHEN INSTALLING AN ELOCKER DIFFERENTIAL READ THE SPECIAL INSTALL INSTRUCTIONS ON PAGE 42.

TOOLS

- Vehicle lift or hydraulic jack and jack stands
- ½ inch pneumatic impact wrench and sockets (recommended)
- Oil drain pan
- Funnel
- Shop light
- Combination wrench set
- Magnetic base dial indicator
- Dial caliper
- Torque wrench
- Shim driver
- Drift punch
- Dead blow hammer
- Ball peen hammer
- Large pry bar
- Telescoping mechanic's magnet
- Gasket scraper
- Hydraulic press
- Extra shims for adjustments

The following instructions should be used as “reference only” for the installation of an Eaton performance differential into a common style axle assembly. If available, the factory service manual should be referenced for complete details and specifications. The installation and proper set-up of an automotive differential should only be performed by a qualified technician due to the specialized nature of the components and operator safety risks. **When installing an ELocker differential read the special ELocker install instructions on page 42.**

Instruction Overview:

There are 3 purposes of these instructions. They are:

1. Replacement of the existing differential
2. Establishing the correct backlash between the ring and pinion gears
3. Setting a correct contact pattern of the gear teeth mesh

The physical installation of the differential pertains to the fitment, clearance to adjacent components (ribs of castings, bolt head clearance, pinion head to differential barrel), correct torque (tightening) of fasteners, bearing preload, lubrication, and most importantly, backlash and gear contact pattern.

Please reference pages 61 and 62 for shimming diagrams.

Replacement of the Existing Differential

1. Prepare the Vehicle for Service

Lift the vehicle so that the tires for the axle worked on are raised off the ground (see “Safety” on page 23 for additional information) to ensure the vehicle is sufficiently immobilized. Use of wheel chocks and jack stands is critical for safety.

2. Prepare the Axle for Disassembly

Remove tires, brake calipers, brake rotors, and/or brake drums to allow the axles to slide out of the differential, permitting the differential removal. For procedures regarding a specific application, consult a factory service manual or quality aftermarket vehicle service manual.

Installation (continued)

3. Drain Axle Lube

Being cautious to prevent spillage, place a catch (drain) pan under the differential. Some axles have a drain plug in the lowest area of the differential housing. Others require removal of the axle housing cover to drain the fluid. The volume of the fluid will vary in each application. The vehicle owner's manual or service manual will list the fill volume of the axle. This can be important when selecting a drain pan. For most automotive service, a four-quart pan should be sufficient to contain the lube. Larger axles in commercial vehicles will have substantially more lube volume.

4. Measurements Before Disassembly (required only if reusing ring and pinion)

Using a dial indicator mounted on a magnetic base, measure the backlash of the existing assembly. Make sure the input pinion is not allowed to rotate. With the ring gear tight to one side of the input pinion, rotate the differential to the opposite side of the tooth contact. Record the value shown on the gauge. Rotate the differential a minimum of 45 degrees. Repeat the measurement and rotation. Collect a minimum of three measurements. If the majority are identical, record that value. If all of the measurements are unique but similar, use the average of the values. If the values vary more than 0.002", start over until the values begin to match. Variation in values is most often due to the input pinion rotating during inspection. Be sure to inspect the condition of the pinion fitment. The input pinion should **NOT** have noticeable axial (in and out) movement. The input pinion bearings should have some value of preload, keeping the input pinion solidly positioned and providing a small rotational drag (resistance to turn). If the input pinion shows any signs of loose fitment, your backlash values will not be useful and the issue needs to be resolved before continuing. Start by inspecting the pinion nut torque and bearing condition.

TIP: IF THE VALUE MEASURED IS NOT WITHIN THE FACTORY SPECIFICATION, THE MEASUREMENT SHOULD BE RETAKEN. IF THE DIFFERENTIAL THAT IS BEING REPLACED WAS DAMAGED IN A MANNER THAT ALTERED THE BACKLASH (BEARING OR SHIM FAILURE), CONSULT THE VEHICLE SERVICE MANUAL AND/OR RING AND PINION GEAR SET INSTALLATION

 CAUTION
READ AND COMPLY WITH THE MANUFACTURER'S SAFETY WARNINGS AND PRECAUTIONS. DO NOT USE HEAT (TORCH) TO DISASSEMBLE THE DIFFERENTIAL. HEATING THE COMPONENTS CREATES RISK TO THE MATERIAL PROPERTIES OF THE COMPONENTS, POTENTIALLY CAUSING SEVERE REDUCTIONS IN STRENGTH, AND PHYSICAL DISTORTION.

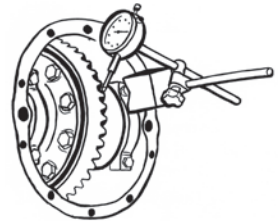

Step 4

Installation (continued)

MANUAL. IF SIGNIFICANT DAMAGE IS NOTICED, REPLACEMENT OF THE RING GEAR AND DRIVE PINION IS HIGHLY RECOMMENDED.

If reusing the ring and pinion gears, running a gear pattern check on the gear set also is advised. If possible, photograph the pattern of the gear set before removal. This pattern can be used as a comparative check at the completion of installing the performance differential. Consult the hypoid ring and pinion gear pattern support pages for proper techniques of generating a usable pattern.

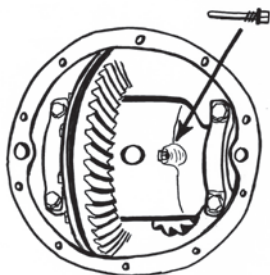

Step 5.A.a

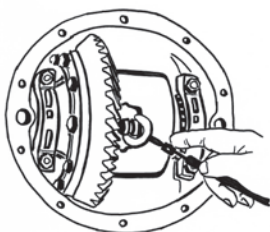

Step 5.A.c



Step 5.A.d

5. Removing Axle Shafts (see image index for term descriptions)

- A. C-Clip axles
 - a. Remove the differential cross-shaft retainer bolt
 - b. Slide the cross-shaft out of the differential. The shaft is not pressed into the case, but may require a small amount of pressure or force to remove if the unit has been in service for an extended time. The differential may have to be rotated to allow removal of the cross-shaft. This can be accomplished by shifting the vehicle into neutral or removal of the drive shaft. Use caution when performing either option to ensure the vehicle is still safely immobilized.
 - c. With the cross-shaft removed, the axle shafts can be pushed inboard slightly. Looking through the differential case window, this movement will expose the c-clips by sliding them from the differential side gear pockets. The c-clips are used to retain the axle shafts (while installed, the cross-shaft keeps the c-clips positioned within the pockets of the side gears of the differential). With the clips exposed, remove them from the axle shaft. A magnet, pick or fine pliers will aid in this process.
 - d. To avoid harming the axle seals, carefully slide the axles out of the differential. Some lube will likely drip from the ends of the axle housing. Place an absorbent cloth under the end of the axle tube before disassembly to help contain leakage.
 - e. The axle shafts should be completely removed from the axle assembly and marked as to which side they were removed from.
 - f. The two shafts are often slightly different in

Installation (continued)

length and swapping them could result in catastrophic failure of the axle assembly. If the axle shafts are not fully removed, take great care not to allow the axles to rest on the axle seals. The distortion will damage the seals and likely cause lube leakage. Carefully inspect the c-clips for wear. Witness marks from light rubbing are acceptable. However, if you can feel ridges on the c-clips, replace them with new components. If the c-clips are conical, there is an incorrect fit between the installed differential cross-shaft or spacer and the axle shaft tip button width. There should never be more than 0.040" clearance between the end of the axle shaft and the cross-shaft or spacer. If you suspect a problem, consult the vehicle manual or contact the Eaton customer help hotline.

B. Non-C-Clip axles

- a. Remove the axle bearing retainer plate at the wheel ends of the axle. These often are a steel plate, typically retained by four or more fasteners clamping them to the axle tube flange.
- b. With the retainer plates unfastened, the axle shaft should slide out of the axle housing. Some axle models may require the use of a slide hammer or similar tool to free the axle shaft and bearing assembly from the axle housing. Again, use caution not to harm the axle seals. Some lube will likely drip from the ends of the axle housing. Placing an absorbent cloth under the end of the axle tube before disassembly should help contain the leakage.

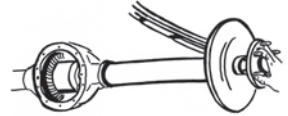

Step 5.B.b

C. Bang Ring (expanding internal retaining rings) / CV / stub shaft / flange shaft axles (non-beam axle types IFS/IRS).

- a. Consult the service manual to identify the appropriate method of removal for the given application.
- b. Look for a stub shaft retaining plate or flange nut. If there are no visible retaining bolts or nuts, the axle is likely retained by an expanding internal retaining ring (bang ring).
- c. For clipped axles (bang rings, for example), use a slide hammer or suitable pry bar and gently remove the stub shaft from the differential. Be cautious not to harm adjacent components during removal. Some lube will likely drip from the seals.

Installation (continued)

6. Removing the Differential

- A. Salisbury style axle
 - a. Mark the bearing caps (may be factory marked) as to which side and direction they are installed. Bearing caps are not interchangeable and must be reinstalled in the same position and orientation. Some manufacturers mark the caps with vertical and horizontally oriented letters stamped on the caps and adjacent gasket surface. Matching the symbols prevents mismatching the caps during reassembly. If no markings exist, stamp, scribe or otherwise mark the factory position and orientation of the caps so that it will not rub off during cleaning and reassembly.
 - b. Loosen the bolts retaining the bearing caps. Certain manufacturers and many racing axles may also use aircraft safety wire, which must be removed as well. If bearing preload adjusters are used, back the left-hand (ring gear side) adjuster a few rounds into the axle housing to remove the preload. Moving only the left-hand adjuster will aid in setting up the new differential if reusing the ring and pinion gears. Be sure to remove the bolt retaining the adjuster positioning/retainer hardware. The retainer is typically a large gauge wire looped around a fastener near the carrier bearings with the ends positioned in the spanner holes of the adjuster.
 - c. Remove the bearing caps and bolts. Use caution as the differential can now fall out of the axle, especially if it uses threaded preload spanner adjusters.
 - d. When servicing axles that use shims to establish the bearing preload, a case spreader is recommended to remove the preload force. Refer to the vehicle service manual for the maximum amount of force/distance that can be applied to the housing. Excessive force or travel will permanently damage the axle housing. Many housings can be permanently damaged if the case is spread more than 0.020" of an inch. If a case spreader is not available, pry bars can be used to persuade the differential from the housing. Observe extra caution if the vehicle is suspended on a lift. When the differential "pops" out of the housing, damage to the unit and/or the mechanic can occur if the unit is not restrained.

Installation (continued)

Use extreme caution if pry bars are utilized. Only pry on the barrel of the differential, ring gear bolts or differential assembly fasteners. Alternating from side to side will “walk” the differential out of the housing. Very close attention must be given to the safety of the internals of the axle. Do not pry against the pinion or any sensors (ABS, tone wheel, factory electronic hardware, etc.). Contacting any of these parts with a pry bar can easily damage them beyond repair.

- e. Remove any loose shims and bearing cups, recording their position. These will be the starting point for shimming if the ring and pinion are being reused.
- B. Drop-out (pig / third member) style axles
- a. Unbolt the carrier housing from the axle assembly and remove it. Some lube will likely drip from the gasket area.
 - b. Refer to the “Salisbury-style” section above for completion of differential removal from the carrier.
- C. Banjo, IFS (Independent Front Suspension), IRS (Independent Rear Suspensions) and quick-change style axle.
- a. Many differing versions of these axle styles exist in the market and each manufacturer has unique methods for assembly.
 - b. Please consult the vehicle factory service manual or axle manufacturer’s service manual to ensure safe disassembly without damage to components.

7. Removing Ring Gear

- A. Using a pneumatic impact gun will greatly aid in the removal of the ring gear bolts. If an impact gun is not available, clamping the differential and use of a breaker bar and socket is an alternative. Verify the thread direction. Some ring gear manufacturers use reverse threads. Use extreme caution when clamping the differential. Some styles can be easily damaged if clamped incorrectly. Never clamp on the ring gear or bearing shoulders. Use the barrel area whenever possible.
- B. Note the presence and orientation of a tone ring (a.k.a. tone wheel, reluctor ring) clamped between

Installation (continued)

the ring gear and the differential flange. If a tone wheel is present, mark the orientation of the part. Flipping the ring can cause interference and incorrectly position the reluctor teeth. This can cause severe damage and remove the functionality of the ABS (Anti-lock Brake System) sensor and traction control systems.

- C. The ring gear should be pressed onto a pilot diameter of the differential. However, some aftermarket gears are not machined with the same precision as factory gears. Although a press fit for the ring gear onto the case is highly preferred, a piloting slip fit will work. The primary function of the press fit is to guarantee the ring gear is centered to the carrier bearings, ensuring the least amount of ring and pinion gear whine. The proper centering of the ring gear also optimizes the loading of the teeth and is a major help in properly setting the gear lash between the ring and pinion. All of Eaton's performance differentials are designed and manufactured to the factory specification (or better) and result in a fit that is second to none. To remove the ring gear from the differential, a large press creating pressure around the entire ring gear is preferred. If a press is not available, two other options exist.
 - a. [Preferred] Place a punch or drift (made from non-hardened steel) into the threaded bolt hole of the ring gear. Select the largest punch possible to fit within the hole without damaging the threads. Working in an alternating crisscrossing pattern around the bolt circle pattern, gently "walk" the gear off of the differential case. Use caution not to use too much force. Excessive force can damage the strength and shape of the ring gear.
 - b. [Alternative] A lead or brass hammer (or drift) can be used, contacting the ring gear just outboard of the differential flange diameter. Use caution not to apply force directly to the teeth on the ring gear. Hammering, even with a soft-faced material, can damage the teeth of the ring gear.
 - c. Use caution while unseating the ring gear from the pilot diameter on the differential case as it will fall once free. Pad or restrain the gear as necessary to prevent damage.

Installation (continued)

8. Reassembly of Ring Gear

- A. Whether reusing the existing ring gear or new gear set, thoroughly clean the ring gear and differential flange. **IT IS WISE TO LIGHTLY LAP A FINE FILE OVER THE EDGES OF BOTH THE DIFFERENTIAL FLANGE AS WELL AS THE BACK FACE OF THE RING GEAR. EDGES CAN BE DISTURBED DURING SHIPPING, RAISING BURRS THAT CAN HAMPER GEAR FITMENT.** Remove any existing debris including residue of thread locker compound, lube, etc. Gently running a clean bolt or tap in the ring gear bolt holes, followed by a cleansing with brake cleaner, will typically clean the threads sufficiently. Use caution when using any aerosol products.
- B. If a tone ring is utilized on the differential, reassemble the ring as it was removed.
- C. Some Eaton performance differentials are machined with multiple ring gear bolt patterns to accommodate many models of factory ring gears and unique aftermarket ring gears. Select the pattern that offers the tightest fit to the fasteners for the intended ring gear. An example would be Dana 44 units. Ring gears exist with 3/8", 7/16", and 1/2" fasteners. Eaton performance differentials for this application are typically machined with both 7/16" and 1/2" clearance holes. This allows the fitment of the two smaller bolt sizes into the small pattern, and the larger fasteners into the larger hole pattern, thus ensuring sufficient material under the bolt heads to allow proper tensioning of the fastener. A close fit between the bolt and the differential is not required if correct ring gear bolts are used.
- D. To align the bolt holes on the ring gear, slide the ring gear onto the differential until the gear approaches the press fit pilot diameter. Using longer than stock bolts placed through the differential flange holes, lightly start the bolt threads into the ring gear. At least two fasteners should be used to align ring gear orientation. Many models of differentials use ring gear bolts that are long enough to start into the ring gear threads. After the ring gear is aligned to the differential flange, start all of the remaining bolts. Do not tighten the bolts more than hand tight. **DO NOT DRAW THE RING GEAR DOWN WITH THE BOLTS** at this time.

ELOCKER ONLY

BEFORE PROCEEDING BE SURE TO READ THE ELOCKER SPECIFIC INSTALLATION INSTRUCTIONS ON PAGE 42.

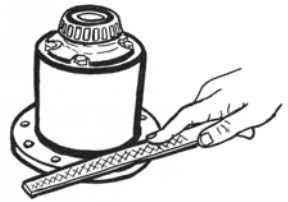

Step 8.A

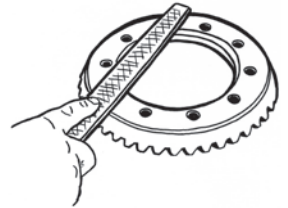

Installation (continued)

- E. New ring gear bolts are highly recommended on any application for performance enhancements. Quality new ring gear bolts often have dry patch thread locking compound. If reusing the ring gear bolts, clean all oil and previous retaining compound from the fasteners. Whichever fasteners are used, a thread locking compound must be used. If a lock patch is on the new fasteners, this is preferred. If it is not present, or when reusing bolts, a quality thread retaining compound such as Loctite 263 (high strength red, oil tolerant, primerless) should be used per the guidelines of the manufacturer. Do not apply the thread retaining compound until the ring gear is fully seated and the bolts are ready to be torqued to their final specification. If the ring gear bolts are drilled for aircraft safety wire, ensure the bolts are wired correctly. Several resources are available online and in manuals for best-practice techniques.
- F. To fully seat the ring gear, start by ensuring that it is parallel to the differential flange as it starts to seat onto the press-fit diameter of the differential pilot. The preferred method to finish the ring gear installation is by evenly and squarely pressing it in a shop press. If there is no access to a shop press, the ring gear can be gently seated using the old ring gear bolts. Working in a cross-pattern method (similar to wheel lug tighten sequence), tighten the bolts no more than a one-half rotation per turn. Continue this method until the ring gear is seated. To avoid permanent damage of the ring gear threads, do not tighten the bolts more than the final assembly torque value. The ring gear threads are very sensitive to torque due to the often reduced bolt engagement length.
- G. Remove the ring gear bolts after the ring gear has been seated. **BEFORE PROCEEDING, VERIFY THE CORRECT TORQUE SPECIFICATION FOR THE RING GEAR BOLTS – AND HAVE THE PROPER TOOLS READY.** If using new bolts with a thread lock patch pre-applied on the threads, thread them into the ring gear. Ensure the patch provides some resistance. If the patch does not provide resistance, remove and apply liquid thread lock. If installing the original bolts, or new bolts without a thread locking patch, apply the recommended thread locking liquid per the manufacturer's recommendation. Torque the ring gear bolts per the specifications of the service

Installation (continued)

manual or ring gear manufacturer's specification. Alternate the pattern in a cross-pattern method to draw down the ring gear.

9. Installing the Differential into the Axle

- A. For outboard shims or threaded spanner preloaders:
If the application utilizes outboard bearing shims or threaded spanner adjusters, press the carrier bearings on the differential. Exercise great care to only press on to the inner race of the bearing. If pressure is applied to the needle cage, the bearing can be easily destroyed. (Hint- use only name brand, high quality bearings. Unless the bearings have very limited service, carrier bearings should be replaced during differential installation.)
- B. Inboard shims:
Install the original shims from the old differential on to the new differential. If set-up bearings are available (bearings or simulation tools with the inner diameter machined large enough to remove the press-fit of the bearing, yet maintain a tight slip fit; Mopar Essential Tools and Service Equipment offers an excellent variety), install them outboard of the shims. If no set-up bearing or mock bearing tools are available, the bearings will likely need to be installed and removed very carefully during the next steps of setting gear lash and gear contact pattern.
- C. Caps:
With the differential (including real bearings, set-up bearings/cups, or simulated bearings) placed in the axle, align the bearing straddle caps and start the cap bolts. Double check the orientation and placement of the bearing caps. **THE BEARING CAPS ARE NOT INTERCHANGEABLE.** If used, any outboard shims or spacers can be installed at this time. Lightly tighten the cap fasteners. The bearings need to be seated, but the cups need to be capable of sliding under the bearing straddle caps.
- D. Preload:
When installing a differential that relies on shims for the bearing preload, consult the service manual for the correct value. The preload of the carrier bearings is to ensure correct fitment and constant contact. An example of a common preload value on small Dana axles is 0.003" to 0.005" total. If conical carrier bearings have too little preload, the

Installation (continued)

differential will be able to “walk” or “bounce” from side to side in the axle housing. Even the slightest motion will severely damage the bearings and likely result in severe ring gear noise. Too much preload can overstress the bearings and also result in heavily reduced bearing life. A conical-bearing-mounted differential is more sensitive to a loose fit than a slightly tighter fit. If threaded spanner adjusters are used in the axle, tighten them per the service manual’s instructions. Establishing the proper preload plays a large role in preventing ring gear whine (noise), and a long bearing service life. Preload can be checked with a dial indicator mounted on a magnetic base and placed along the axis of the differential. Using a pry bar, verify the lack of lateral motion of the unit. If the needle moves when light pressure is applied, it does not have sufficient preload.

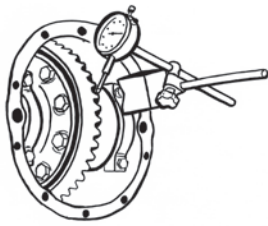

Step 9.E

E. Backlash:

When reusing a ring and pinion set (and only when the pinion has not been removed), the differential should be shimmed or adjusted to return the backlash to match the value measured and recorded before the original differential was removed. If the pinion was not removed from the axle assembly, the original shims should locate the differential close to the correct value. If the gear set has been changed or the pinion removed for bearing/seal service, the backlash may be substantially out of the factory tolerance range. Consult the vehicle service manual, ring gear installation guide, and/or the pattern and shimming guide included in this installation guide. Adjust the shimming to achieve the correct (factory spec) range, and match the backlash recorded if simply upgrading the existing differential to a performance differential.

F. Pattern:

Setting the gear set to the correct backlash is the starting point for setting the contact pattern of the ring and pinion gear teeth. The positioning of the contact location of the pinion teeth on the ring gear teeth is the most important step in the installation of a performance differential. The strength, noise, and life of the gear set is totally dependent on establishing the correct contact pattern. Consult the included hypoid gear contact pattern guide for tips to resolve any issues and verify a correct pattern. If the gear set

Installation (continued)

has been reused, the pattern should be nearly identical to the pattern run before removing the original differential.

TIP: THE GEAR CONTACT PATTERN OF HYPOID GEAR SETS IS EXTREMELY CRITICAL. IF THE PATTERN IS NOT DEVELOPING, SEEK HELP FROM A QUALIFIED RESOURCE.

10. Reassemble Axle

Proceed **ONLY** after the correct backlash and pattern are set on the hypoid gears.

- A. **TIP: BEFORE CONTINUING, IDENTIFY THE PROPER TORQUE VALUE FOR THE CARRIER CAP BOLTS AND HAVE THE TOOLS REQUIRED AVAILABLE.** Remove the carrier bearing cap bolts one at a time. Clean any oil from the threads and apply a medium or heavy-duty thread locker (i.e. blue or red) to the threads, per the thread locker's instructions. Reinstall the carrier cap bolts and torque to the specification listed in the vehicle service manual. **TIP: RE-CHECKING THE EXISTENCE OF BEARING PRELOAD, CORRECT BACKLASH, AND GEAR CONTACT PATTERN IS HIGHLY ENCOURAGED. UPON FINAL TORQUING OF THE CARRIER BOLTS, THE DIFFERENTIAL COULD SHIFT SLIGHTLY.**

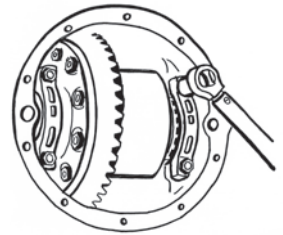

Step 10.A

- B. Reinstall the axle shafts
- a. If the axles use c-clips, install them deep into the axle to expose the clip groove on the end of the axle shafts while looking through the differential case window. Insert the c-clips. **TIP: IF THE C-CLIPS SHOW SIGNS OF DAMAGE (WEAR YOU CAN FEEL OR BENDING), REPLACE THE C-CLIPS. IF THE C-CLIPS ARE FLAT AND ONLY SHOW SLIGHT MARKS OF WEAR (NO MATERIAL DISTORTION OR REMOVAL), THEY CAN BE REUSED. MANY INSTALLERS WILL FLIP THE CLIPS ON THE SHAFT TO PROVIDE "NEW" SURFACES TO THE CONTACT LOCATIONS.** Install the axle spacer. This is typically either the pinion gear cross shaft or a hardened steel plug and retaining ring (often used in c-clip models of Truetracs and Detroit Lockers). If the differential uses a cross shaft, install its retaining bolt. Use medium duty (blue) liquid thread locker on the fastener's threads. Torque the fastener to the value listed in the

Step 10.B.a

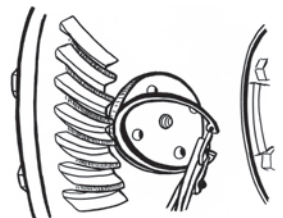
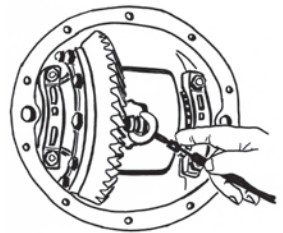

Installation (continued)

vehicle service manual. The gap between the end of the axle shaft “button” and the cross shaft / spacer should be checked with a feeler gauge. The gap should be less than 0.040”. If it is too large, and the original equipment axles are being used, contact Eaton Performance. If the gap is large and aftermarket shafts are used, contact the axle shaft manufacturer to resolve the issue. Eaton performance differentials are designed to the original equipment axle gap specifications. Some models of Truetrac products may contain a selection of spacers to accommodate variations in original equipment fitments (i.e. Ford 8.8” uses multiple cross shaft diameters). If multiple spacers are included with the differential, always use the thickest spacer possible.

- b. If the axles are retained by the outer bearings and retainer plates, reinstall the axles into the axle assembly tubes. Use caution when sliding the axle seal back into position. The seals can be easily damaged during reassembly. If reusing the axle bearings and seals, a small amount of silicone/RTV around the perimeter of the seal structure may reduce chances of leakage. **TIP: WHEN POSSIBLE, REPLACEMENT OF THE AXLE BEARINGS AND SEALS IS ADVISED.** Torque the retainer fasteners to the specification from the vehicle service manual. Some retainer plates use press-in studs. Over-torquing pressed studs can cause significant problems. **TIP: WHEN REMOVED, SOME INSTALLERS PREFER TO TACK WELD PRESS-FIT STUDS TO THEIR RETAINER PLATES TO REDUCE INSTALLATION FAILURES.**
- c. If reinstalling full floating axles, ensure the sealing surfaces, o-rings (if used), and retainer bolts are clean. Non-gasket flange interfaces should be sealed with a thin layer of silicone/RTV. Apply medium or heavy-duty (blue or red) liquid thread locker. If the fasteners are drilled for aircraft safety wire, reinstall per vehicle or axle manufacturer’s instructions.
- d. Reinstall the differential inspection cover (non-third-member axles).
- e. Fill the axle with the appropriate volume of the correct lubrication. Consult the vehicle service manual for the volume of lube, and correct for any performance modification affecting the required volume, such as extra-capacity differential covers

Installation (continued)

and axle assembly positioning for driveshaft alignment. Consult the vehicle service manual and the recommended lubricants page within this installation guide to determine the correct type of lubrication. Always use a quality lube to ensure the highest performance from the differential and longest life of the lubricated components. If questions regarding lubrication still exist, contact the Eaton Performance hotline or website www.EatonPerformance.com.

- f. Reinstall the brake system components.
- g. Reinstall the wheels and any remaining components removed for service. Consult the vehicle service manual for original equipment wheels, or aftermarket wheel manual if such wheels are installed. Proper torque values are critical to ensure safe operation of the vehicle.

11. Verify Differential Function

See the specific differential section in this manual for proper function testing methods.

ELocker Installation Instructions

CAUTION

Vehicle steering may be impaired while driving with the differential locked.

Do not operate a vehicle with a locked differential above speeds of 20mph.

Disengage a front axle installed Eaton ELocker immediately once free of low traction conditions.

Use caution while accelerating with a differential locked on low traction surfaces.

Improper use of a locked differential may damage driveline components.

Only engage the Eaton ELocker while vehicle speed is under 5mph with limited or no wheel slip occurring.

Continuous usage of a locked differential on high traction surfaces will strain driveline components.

Reduce driveline torque while disengaging the Eaton ELocker and allow locking components to release freely.

The following steps outline the installation procedures unique to Eaton ELocker differentials. It is recommended that you also read the general installation guide for an overview prior to beginning the installation. Please consult the vehicle service manual, in conjunction with these instructions, to properly assemble and disassemble all components.

Step 1 – Be safe

To ensure your safety and the safety of the vehicle's electrical system, disconnect the battery during the harness wiring.

Step 2 – Familiarize yourself with the wiring harness

Review the wiring diagram and understand the electrical circuit design.

Step 3 – Begin to Install Wiring

Begin to lay out the wiring for the installation. Temporarily position wiring in its intended location along the chassis from the axle housing to the relay. Position the wires so they are protected from sharp edges, moving components, and possible pinch points. Ensure the harness entry point into the vehicle cabin is in a convenient location and protected from sharp edges by using a grommet or suitable abrasion prevention method.

Step 4 – Mount Relay

Identify an appropriate location under the dash or in the engine compartment and securely mount the relay.

Step 5 – Install Harness Switch (any similar automotive style 12V DC switch can be used)

Locate a point on or near the dash with unobstructed driver access. The switch should be mounted for convenient use. Carefully cut the switch appropriate opening in the panel. Before inserting the dash switch in the opening, securely connect the wires to the switch through the opening, per the wiring diagram. Secure all excess wire out of sight and away from possible harm.

Step 6 – Connect to Power Supply

Securely connect the RED power wire to a constant 12V power supply, such as the positive terminal on the battery or a live terminal at the junction box. Connect the BLUE wire to an ignition controlled "switched" power supply. This power supply should only be active

ELocker Installation Instructions (cont.)

when the vehicle is running or the ignition is turned "on." Connecting the blue wire to an ignition switched source prevents any chance of the ELocker draining the vehicle's battery while the vehicle is not in use. Connect the BLACK wire to a clean and appropriate chassis ground on the vehicle, such as the negative terminal of the battery or a factory electrical ground stud on the body.

Step 7 – Identify type of Eaton ELocker Differential

Depending upon your specific axle size, you may have one of several different Eaton ELocker differential designs.

As shown in the figure below, the differential on the left is a "collar style" with a "pin style" shown on the right. Also shown are two methods used to retain the electromagnet and prevent it from rotating. Some pin style ELocker differentials use a retaining bracket that bolts to the top of the bearing cap. The retaining bracket slides around a post on the electromagnet. Other ELocker differentials similar to the pin style ELocker utilizes two tabs on the electromagnet which contact the inside surface of the differential carrier to prevent the electromagnet rotation. Knowing the design and what type of retaining system you have will aid in your installation.

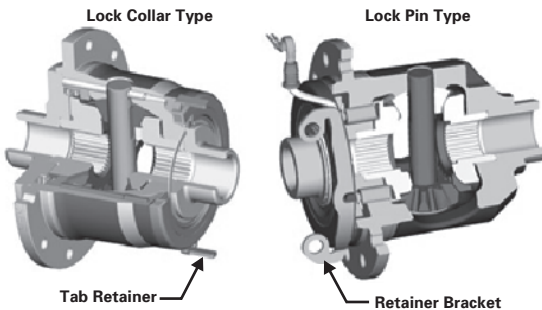

NOTES

Be sure to understand the special installation instructions before proceeding:

- Dana 30/35: page 49
- Toyota ELockers (14218-1, 14219-1, 14220-1, 14221-1): page 50/56

CAUTION

CAUTION – Anti-rotation brackets utilizing tabs MUST be floating. The coil should not be bound, pinched, or wedged during installation. If a tab-style anti-rotation coil is not allowed to float, electrical failure and accidental engagement can occur. After completing initial installation, check to ensure the coil "floats" on the differential body. Light finger pressure should be sufficient to rotate the coil while not energized. If the coil does not float freely, investigate its surrounding components and adjust accordingly. Often, gently flexing the tabs will free a bound coil. Use caution and common sense when ensuring coil clearance. In very rare occasions, axle manufacturers alter casting walls and / or rib designs on select applications which can generate interference deeper within the axle housing. If a light interference is noted between the axle housing and the coil, minimal material removal from the axle housing should regain the appropriate clearance. NEVER modify an ELocker coil body.

ELocker Installation Instructions (cont.)

STOP

**DANA 30/35 ELOCKERS:
DO NOT PROCEED
WITHOUT READING
THE DANA 30/35
INSTALLATION NOTES
ON PAGE 49.**

**TOYOTA ELOCKERS
(14218-1, 14219-1,
14220-1, 14221-1): DO
NOT PROCEED WITHOUT
READING SPECIAL
INSTALLATION NOTES
ON PAGE 50.**

Step 8 – Drill Grommet Hole

A pass-through hole for the Eaton ELocker coil wire harness grommet will need to be drilled in the upper left or right quadrant of the axle housing, depending upon design. Fit the ELocker into the axle housing taking careful note of wire location. The hole location should be in an area that will keep the wiring away from rotating parts and sharp edges. Determine the ideal grommet location based on wire length, axle housing configuration, suspension / body clearance, and convenience of drilling the hole. The differential should be removed before drilling to reduce the risk of contamination or drilling damage. Prior to drilling, the hole position should be marked and center-punched. Use a ½" (12.7mm) maximum diameter bit to drill the thru hole. Take care when drilling not to contaminate the differential sump with metal shavings. Cover any installed bearings, tube seals, and the pinion before drilling. Thoroughly remove any debris after drilling.



**DANA 30/35 ELOCKERS: DO NOT PROCEED
WITHOUT READING THE DANA 30/35
INSTALLATION NOTES ON PAGE 49.**

**TOYOTA ELOCKERS (14218-1, 14219-1,
14220-1, 14221-1): DO NOT PROCEED
WITHOUT READING SPECIAL INSTALLATION
NOTES ON PAGE 50.**

Step 9 – Seating the Eaton ELocker Differential in the Axle

Place the differential assembly as far as possible into the axle housing firmly grasping the differential, bearing cups, and any shims. As you install, orient the electromagnet so the wire leads exit the newly drilled hole. Application of silicone sealant on the grommet with ensure a water-tight seal. Use caution to not pinch or damage electrical wires while seating the Eaton ELocker differential. Using a heavy leather or rubber mallet, fully seat the differential assembly in the axle housing. Do not strike the electromagnet or speed pick-up ring (if equipped), as damage will occur. A drift punch or shim driver tool may be useful in seating shims. Never use a steel hammer to install any axle components.

ELocker Installation Instructions (cont.)



⚠ CAUTION

CAUTION – Check the axle vent line for obstructions. If the axle is not properly vented, a risk of water intrusion exists during axle submersion in water. A free-flowing axle vent in very important if the vehicle is to be used in deep water.

Step 10 – Final Verification of Correct Fitment

The anti-rotation tabs may need to be slightly bent or filed to ensure free play in the electromagnet when the differential is seated in the axle housing. The coil must “float” in its position. If the coil body touches the axle housing (caps, ribs, housing wall, etc.), the coil can bind against the ramp plate and unintentionally activate the locking mechanism. Check for fitment by lightly attempting to rotate the coil on the differential. If no motion is noticed, check for unintended contact with the coil (refer to caution statement on page 43).

Step 11 – Install Anti-rotation Bracket (2-pc coil and bracket designs)

If the ELocker being installed uses an anti-rotation bracket which is not integrated with the coil, use this step. Locate the anti-rotation tab on the electromagnet. With the bearing cap seated on the electromagnet side, place the anti-rotation bracket over the anti-rotation tab. Install and lightly tighten the bearing cap bolts over the anti-rotation bracket, ensuring it is correctly aligned. Note: The anti-rotation bracket configuration may vary depending on application. The bracket may need to be adjusted to ensure the coil floats on the differential body.

Step 12 – Grommet Installation

Gently slide the grommet along the coil wires to a position to remove any strain from the coil wire termination to the coil during installation. A small amount of differential lube on the wire will greatly aid in sliding the grommet on the wires. Apply a small amount of liquid silicone sealer onto the grommet outer diameter. Gently insert the grommet into the hole previously drilled into the axle housing. If the hole was correctly drilled, the grommet should slide in easily and resist removal.

ELocker Installation Instructions (cont.)

Step 13 – Test Electronics

Temporarily connect the Eaton ELocker differential to the lead lines from the relay as installed previously. Note: A special weathertight connection for the coil wires is provided along with the wiring harness. This is to be installed once the coil wires and grommet are in place. Test the electronics by turning on the ignition in the vehicle. Activate the dash switch to the "ON" position. Examine the armature plate directly next to the electromagnet and confirm that it is firmly drawn into the electromagnet. With the drive axle tires safely raised from the ground, rotate the drive shaft a minimum of one full revolution while attempting to hold one wheel stationary. While the drive shaft is being turned, you should feel the wheel that is being held stationary "lock" as both wheels begin to rotate together. If lock-up is not evident, check to confirm proper electrical connections.

Step 14 – Lubrication

Please refer to page 27 of this manual for proper ELocker lubrication information.

Step 15 – Complete Wiring

Confirm that all wiring and connectors are securely fastened and cannot be caught in moving parts or road terrain. Make sure that the wiring harness is securely restrained as necessary. Be certain to leave excess wire where needed to provide slack for suspension travel as the suspension flexes.

ELocker Installation Instructions (cont.)



ELocker Installation Instructions (cont.)

ITEM DESCRIPTION
1 EATON MGR SWITCH
2 15A MANUAL RESET BREAKER
3 RELAY CONNECTOR
4 RELAY
5 SUPPRESSION RESISTOR
6 5/16 INCH RING TERMINAL
7 1/2 INCH RING TERMINAL
8 1/2 INCH RING TERMINAL
9 FUSE TAP W/ 10A FUSE

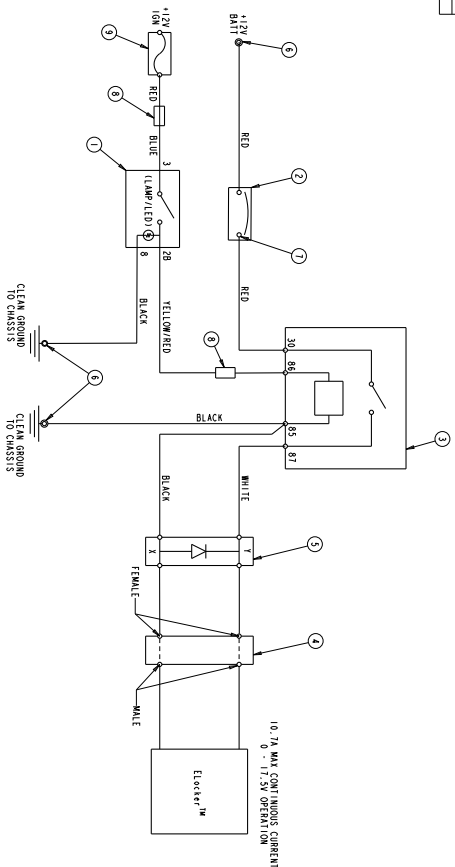

WIRE INFORMATION	
16 AWG 1/7	BLACK
16 AWG 1/7	WHITE
16 AWG 1/7	BLUE
16 AWG 3	BLACK
16 AWG 1/2	YELLOW/RED
18 AWG 1	YELLOW/RED
18 AWG 1	BLACK
18 AWG 2.5	RED

WIRE INFORMATION	
16 AWG 1/7	BLACK
16 AWG 1/7	WHITE
16 AWG 1/7	BLUE
16 AWG 3	BLACK
16 AWG 1/2	YELLOW/RED
18 AWG 1	YELLOW/RED
18 AWG 1	BLACK
18 AWG 2.5	RED

For a larger version of this diagram, visit EatonPerformance.com and click on the ELocker FAQs.

Elocker™ WIRING INSTALLATION KIT w/ RELAY



Torgon Controls
Products Division

DATE	REVISION	ISSUE
ENGINEERING	PLEASE	SEE

ELocker Installation Instructions (cont.)

Dana 30 and 35 ELocker Special Instructions

All Dana 30 and 35 model ELockers require LM102949 bearings and LM102911 races.



REMOVE STATOR ASSEMBLY BEFORE INSTALLING BEARINGS

All Dana 30 and 35 model ELocker differentials require the removal of the stator assembly for the fitment of the ring gear. **This must be done before bearing installation.**

Follow these instructions to remove the stator and install the ring gear on Dana 30 and 35 models:

- Carefully remove the double wound snap ring and lift off the stator assembly and bearing race
- Place the ring gear over the case and replace the stator assembly and bearing race
- Reinstall the double wound snap ring making sure it's fully seated in the groove and the stator will rotate freely
- Carefully turn the differential over and complete the ring gear installation

Notes on bearing installation on Dana 30 and 35 models:

- On Dana 30 models if you chose to shim inboard of the bearings, remove the bearings on the original differential making sure to identify the shim packs for the bell and flange ends
- On Dana 30 models if you chose to shim inboard of the bearings, the use of set up bearings for ring and pinion pattern adjustment is highly recommended
- Start the set up by matching the thickness of new, larger shims to same thickness values as the ones removed from the original differential
- You cannot use a standard clamshell style bearing puller to remove pressed on bearings on either the Dana 30 or 35 models, this will damage the stator anti-rotation tabs

Continued on next page >



ELocker Installation Instructions (cont.)

Other notes on Dana 30 and 35 model ELocker Differentials:

- On Dana 35 C-clip models, some original equipment C-clips measure .165 inch in thickness
- You must use C-clips that measure .156 inch in thickness to allow the yoke and cross pin installation
- On some Dana 30 models it may be necessary to trim the axle shaft ends that fit into the differential approximately 1/16 to 1/8 inch to allow clearance for the 4 pinion center-block

ELocker Toyota® Installation

The ELocker differential for Toyota fitments have different installation / modification requirements depending on part number. This section provides a general guide for modifications required to achieve proper fitment.

ELOCKER - TOYOTA

VERIFY PART NUMBER
BEFORE PROCEEDING.
FOR P/N 14219-1 AND
14221-1 SEE PAGE 56.

Install notes for:

- 14218-1
- 14220-1

- Grind away a small section of rib until the electromagnet does not interfere with the housing as shown below



GRIND AS SHOWN

ELocker Toyota Installation (cont.)



ELECTROMAGNET SHOWN IN POSITION

- Grind away a small section of the boss around the bolt hole until the electromagnet does not interfere with the diff housing as shown below. Also grind the other side for case clearance

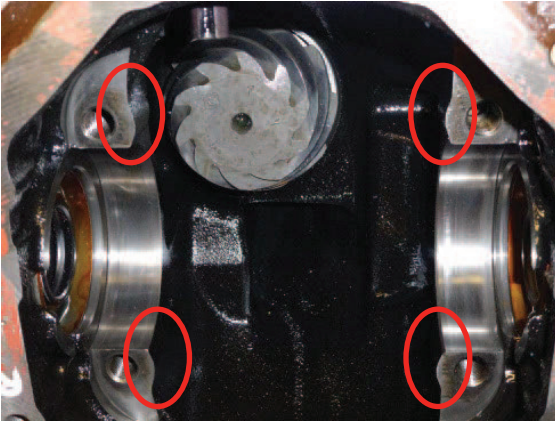

GRIND AWAY BOSS AROUND THE BOLT HOLE

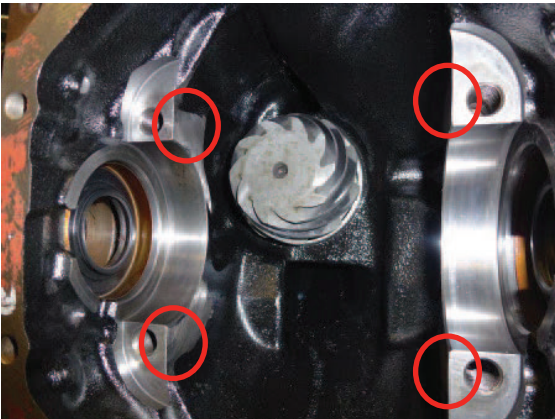

BOSS REMOVED

ELocker Toyota Installation (cont.)

- When installing the 14218-1 and 14220-1 ELocker it is necessary to remove the electromagnet from the center in order to assemble the crown wheel therefore we do not assemble the electromagnet assembly, it is up to the installer to complete this process

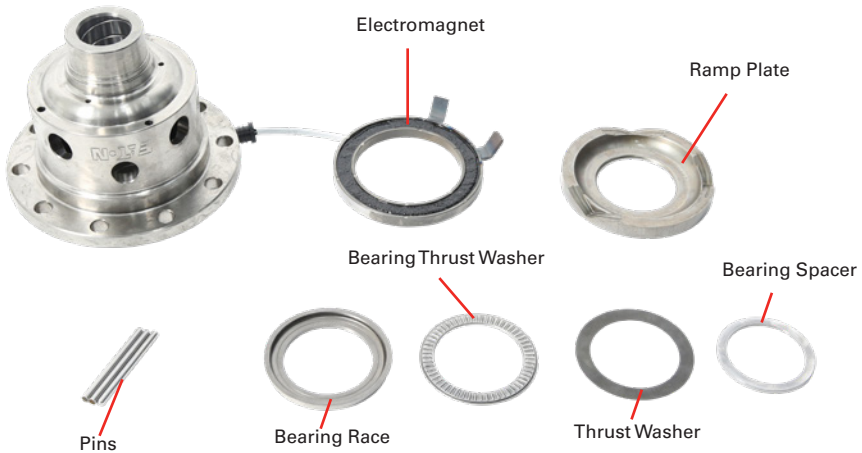

- After installing the crown wheel sit the unit on the bench upright as shown, install the 3 pins as shown with the radii protruding



ELocker Toyota Installation (cont.)

- After the pins have been fitted, install the ramp plate, you will notice the pins aren't evenly spaced, rotate the plate until all 3 pins are sitting in the ramp



- Assemble the thrust washer onto the ramp plate



ELocker Toyota Installation (cont.)

- Now place the bearing thrust washer and electromagnet and the bearing race on



ELocker Toyota Installation (cont.)

- To retain this all in place you must press on the bearing spacer as shown
- Now you can mount your bearings to the center and continue with the installation



ELocker Toyota Installation (cont.)

ELOCKER-TOYOTA
VERIFY PART NUMBER
BEFORE PROCEEDING.
FOR P/N 14218-1 AND
14220-1 SEE PAGE 50.

Install notes for:

- 14219-1
- 14221-1

- Grind away a small section of rib until the electromagnet does not interfere with the housing as shown below
- Grind only as much as required, the rib also acts as the stop for the electromagnet and if too much is ground away there will be no stop left in the housing

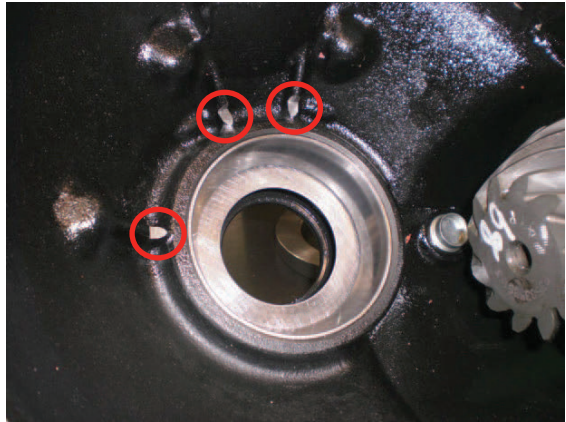

GRIND AS SHOWN

- Ensure electromagnet has seated in the desired grooves on reinstallation into housing

ELocker Toyota Installation (cont.)

- When installing the 14219-1 and 14221-1 ELocker it is necessary to remove the electromagnet from the center in order to assemble the crown wheel therefore we do not assemble the electromagnet assembly, it is up to the installer to complete this process

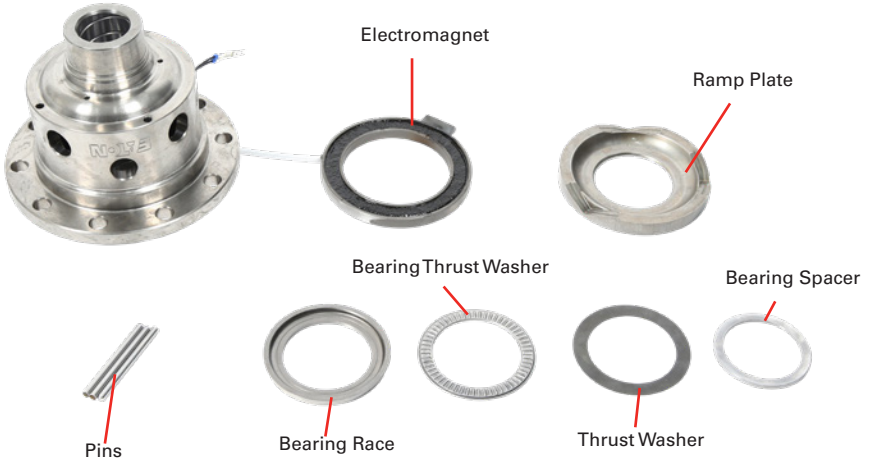

- After installing the crown wheel sit the unit on the bench upright as shown, install the 3 pins as shown with the radii protruding



ELocker Toyota Installation (cont.)

- After the pins have been fitted, install the ramp plate, you will notice the pins aren't evenly spaced, rotate the plate until all 3 pins are sitting in the ramp



- Assemble the thrust washer onto the ramp plate



ELocker Toyota Installation (cont.)

- Now place the bearing thrust washer and electromagnet and the bearing race on



ELocker Toyota Installation (cont.)

- To retain this all in place you must press on the bearing spacer as shown
- Now you can mount your bearings to the center and continue with the installation



Shimming For A Pattern

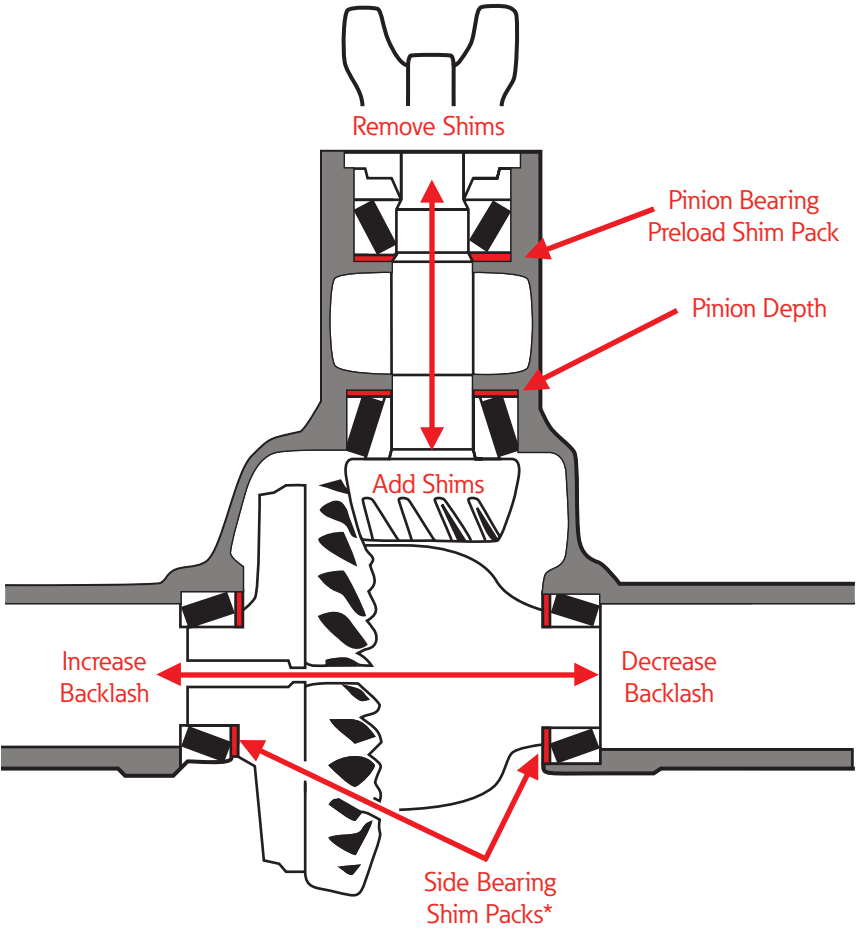

*may be out board of bearings, or utilize spanner style adjuster rings

Shimming For A Pattern (continued)



Ideal Contact

Pattern is spread evenly over the tooth's profile with concentration nearer toe than heel.

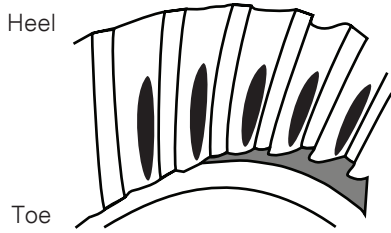

Competition Contact

Pattern concentrated just up from the toe covering one third to one half of the tooth.



Heel Contact

Pattern is concentrated off the heel end of the drive gear tooth. Move the ring gear close to the pinion (decrease backlash) while maintaining minimum backlash.

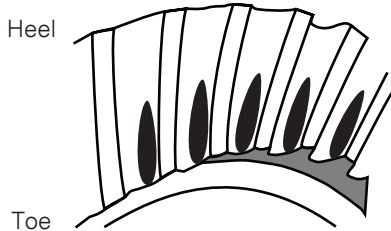

Toe Contact

Pattern is concentrated off the toe end of the drive gear. Move the ring gear away from the pinion (increase backlash) while maintaining minimum backlash.



High Contact

Pattern is concentrated at the crown of the drive gear tooth. Move the pinion deeper in towards the differential carrier (add pinion shim).

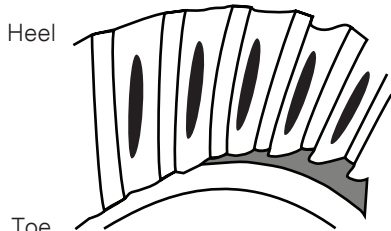

Low Contact

Pattern is concentrated in the root of the drive gear tooth. Move the pinion out away from the differential carrier (subtract pinion shim).

Notes

Eaton Part #:

Axle Installed:

Date:

Ring & Pinion Ratio:

Purchased From:

Backlash:



Powering Business Worldwide

PRINTED IN U.S.A

EATON CORPORATION
26101 Northwestern Highway
Southfield, MI 48076
800-328-3850
EatonPerformance.com
ED-14000 0520