

Medium-voltage power distribution and control systems > Motor control >

# 7.2 kV motor control (Ampgard)— medium-voltage, arc resistant

## Contents

<b>General Description</b> .....	<b>10.2-2</b>
General Description .....	10.2-2
Starter Types .....	10.2-8
Standard Ratings .....	10.2-12
<b>Devices</b> .....	<b>10.2-14</b>
Isolation Switch .....	10.2-14
Contactors .....	10.2-14
Current Limiting Fuses .....	10.2-16
Incoming Line .....	10.2-16
Accessories .....	10.2-16
<b>Layouts and Dimensions</b> .....	<b>10.2-17</b>
Full Voltage .....	10.2-17
Reactor .....	10.2-18
Autotransformer .....	10.2-20
Reduced Voltage Solid-State .....	10.2-22
Arc-Resistant Starter Layout .....	10.2-25
<b>Application Details</b> .....	<b>10.2-26</b>
Typical Wiring Diagrams .....	10.2-26
Fuses and Current Transformers .....	10.2-29
Voltage Transformers .....	10.2-30
Heat Loss Data .....	10.2-30



*Powering Business Worldwide*



*Ampgard Motor Control Assembly*

## General Description

Eaton's Ampgard® medium-voltage metal-enclosed control family provides control and protection of medium-voltage motors and equipment rated 2300–13,800 V nominal/15,000 V maximum. Arc-resistant starters are available from 2300 to 6900 V.

## Application Description

Ampgard control has a complete metal-enclosed offering:

- Full and reduced voltage starting of medium-voltage motors up to 8000 hp
- Incoming cable section
- Can be close coupled with common bus and plenum to Eaton medium-voltage switchgear
- Adjustable frequency drives (SC 9000EP™) up to 4160V, 6000 hp

## Features, Benefits and Functions

**Personnel safety:** Positive mechanical isolating switch with visible disconnect completely grounds and isolates the starter from the line connectors with a mechanically driven isolating shutter, leaving no exposed high voltage. Medium-voltage door is mechanically locked closed with interlocking mechanism; low-voltage section has separate door and is segregated from the medium-voltage section.

**Ease of installation:** Current limiting fuses, contactor assembly and isolating switch assembly are easily removed from the enclosure; line and load terminals are completely accessible from the front.

**Ease of maintenance:** All components are front accessible, facilitating routine inspection and/or parts replacement. The low-voltage compartment is painted white as standard to maximize serviceability.

**Simplicity of design:** Component-to-component design eliminates half of the electrical connections.

**Time-proven contactor technology:** Two vacuum contactor ratings are used: 400 A and 800 A 7.2 kV. 400 A 7.2 kV contactors are available as stab-in or bolt-in design. 800 A 7.2 kV contactors are available as stab-in design only.

**High degree of isolation:** Main bus is located in separate compartment on top of lineup. Vertical bus is barriered in rear of starter. Load cables are isolated from adjacent starter in two-high sections. A vertical low-voltage wireway is provided for isolation of customer control wiring. The low-voltage control compartment is isolated from medium voltage by grounded steel barriers.

Starter catalog types are available for the following applications:

- Squirrel cage, full voltage (reversing and non-reversing)
- Squirrel cage, primary reactor
- Squirrel cage, autotransformer
- Reduced voltage solid-state
- Two-speed, two winding
- Two-speed, one winding

## Arc-Resistant Ampgard

When specified, Ampgard is available in special arc-resistant construction. Ampgard AR is available with a 49 kA, 0.5 sec rating. The design has been tested and verified to meet the requirements of IEEE C37.20.7-2007 for Type 2B construction. Type 2B construction is defined as arc-resistant at front, back and sides of the enclosure with the low-voltage compartment door open. Most types of 400 A and 800 A starters, as well as 24-inch (610 mm) wide incoming cable sections are available in arc-resistant construction. A common plenum design to close couple to Eaton arc-resistant switchgear is also available. Consult Eaton for ratings on this design. Main Breaker Ampgard, LBS load break switches and 15 kV starters are not available in arc-resistant construction. Due to the specific nature of arc-resistant testing, no modifications may be made to the enclosure while maintaining the arc-resistant rating. Consult Eaton for more details.



*SC 9000EP 4160 V, 2500 hp AFD*

*MV4S  
RVSS 2-High  
FVNR*

*Ampgard AR Arc-Resistant Close-Coupled with SC 9000EP Arc-Resistant Drive*

## Personnel Safety Features

One of the most important considerations in designing the Ampgard starter was personnel safety. The result is an extensive system of interlocks and other safety features.

### Interlocks

Interlocking on Ampgard starters includes:

- Isolating switch mechanism locks the medium-voltage door closed when the switch is in the ON position
- Provision for optional key interlocks
- When door is open, interlock prevents operating handle from being moved inadvertently to ON position
- When contactor is energized, isolating switch cannot be opened or closed

### Other Safety Features

Ampgard starters include many additional features designed to protect operating personnel. These features include:

- Provision for a padlock on the isolating switch handle in OFF position
- Shutter barrier between line terminals and isolation switch stabs is mechanically driven
- Distinctive marking on switch assembly appears when shutter barrier is in position and starter is completely isolated from the line
- Grounding clips provide a positive grounding of the starter and main fuses when the isolating switch is opened
- High- and low-voltage circuits are compartmentalized and isolated from each other
- The drawout isolation switch is easily removed by loosening two bolts in the back of the switch. The shutter remains in place when the switch is withdrawn

## Standards and Certifications

### UL, CSA and IEC Certification

Ampgard starters are designed, assembled and tested to meet all applicable standards:

- NEMA/ANSI ICS3
- UL 347
- CSA® C22.2 No. 14
- C37.20.7-2007

The major components, i.e., contactor, isolating switch, fuses, EMR-3000 and EMR-4000 are UL recognized.

UL or CSA labeling of a specific starter requires review to ensure that all requested modifications and auxiliary devices meet the appropriate standards. Refer to factory when specified. Ampgard starters meet the requirements of IEC standards 60694, 60298 and 60470.

**Isolated Low-Voltage Control**

The low-voltage door has four cutouts as standard.

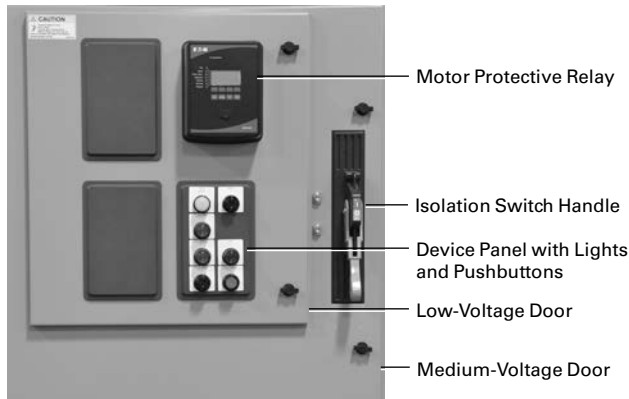

**Ampgard 400 A Starter Door Closed**

Distinctive Markings on Isolation Switch Shutter Indicate Shutter is Closed and Switch is Open

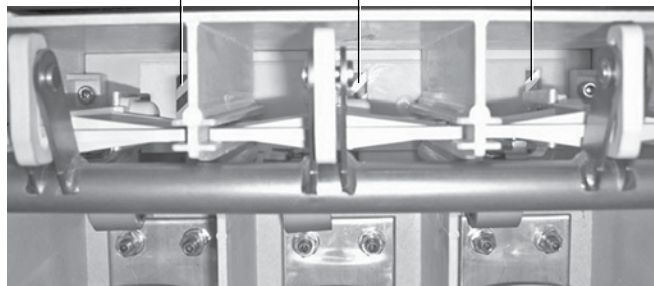

**View of Isolation Switch Through Viewing Window**

Device panels are provided on the low-voltage door to simplify the mounting of pilot devices. The low-voltage control panel is behind the low-voltage door and is completely isolated from the medium-voltage compartment. A standard viewing window allows visual verification of the isolation switch status before attempting to open the medium-voltage door. The medium-voltage door is locked closed whenever the isolation switch is closed.

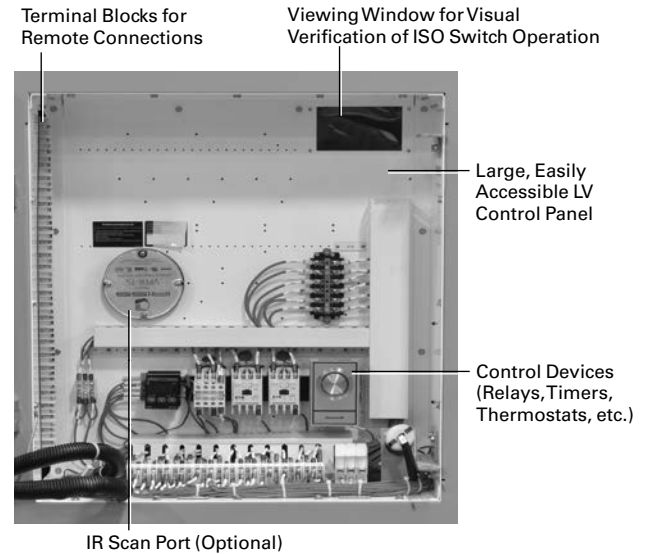

**Ampgard 400 A Starter—Low-Voltage Compartment**

Estimated low-voltage compartment dimensions  
22 inches W x 25 inches H x 8 inches D.

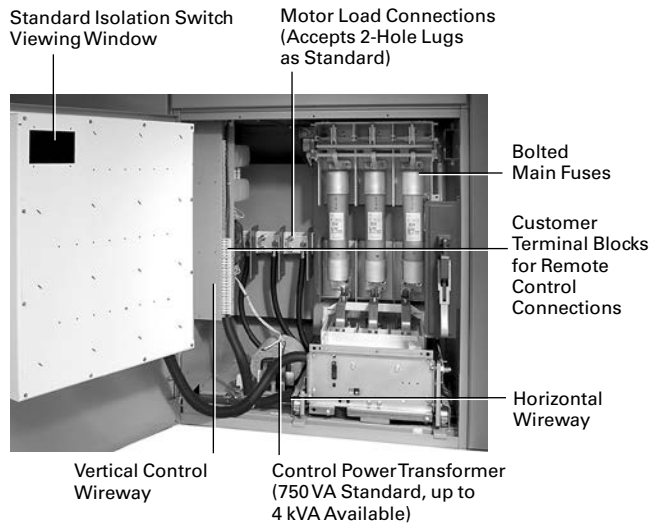

**Ampgard 400 A Starter—Medium-Voltage Door Open  
Shown in Non-Arc Enclosure**

## Bus and Optional Features

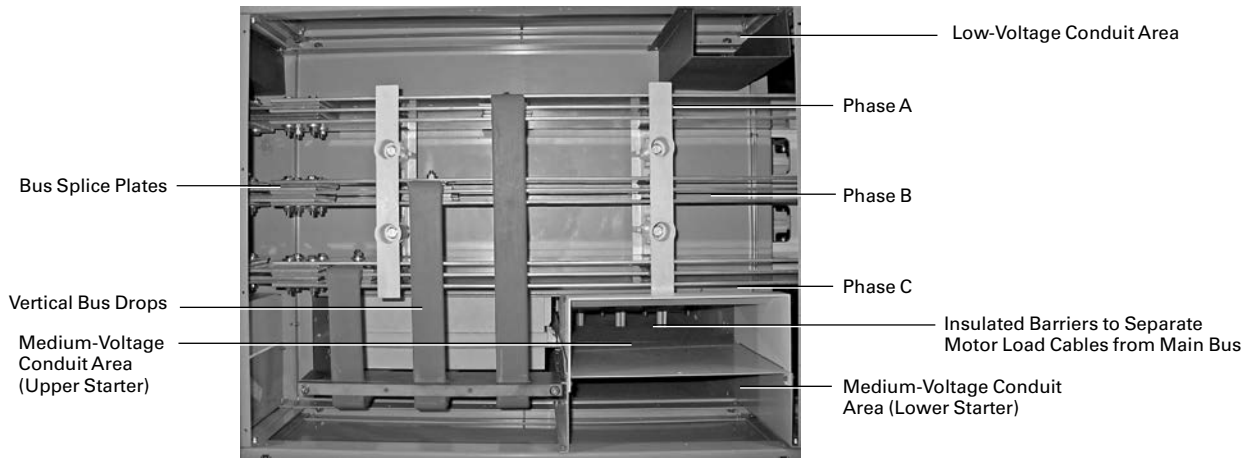

**Bus Compartment Top View 3000 A Main Horizontal Bus**

### Main Bus

When starters are grouped together in a lineup, a typical option is the main bus. The Ampgard main bus is mounted in its own 15-inch (381 mm) high top-mounted enclosure, which isolates it from the starter. The connection from the main bus to the starter is done with rigid vertical bus. Insulated barriers are provided for separate top entry of power and control cables. The main bus is top accessible, which allows for ease of maintenance or extension of lineup without disassembling the starters.

Main bus is available for 1000, 1200, 2000 and 3000 A. Fully insulated bus is standard on arc resistant starters. Bus may be supplied with either tin or silver plating.

The standard bus short circuit rating is 50 kA for 10 cycles per NEMA and UL standards. An optional 50 kA, 2-second bus rating is available for customers that require a higher rating for the main bus.

### Vertical Bus

Vertical bus is located behind a fixed barrier in the rear of the enclosure. It is fully insulated as standard, with plating to match that of the main bus.

### Other Optional Features

Ampgard starters are available with a variety of accessories and modifications to satisfy a wide range of application requirements. Some of the broad areas covered include:

- Cable entrance enclosures
- Transformers
- Power factor correction capacitors
- Operators and pilot devices
- Instruments and meters
- Control relays and timers
- Solid-state or selected electro-mechanical protection devices



**Vertical Bus, Rear View (2-High 400 A)  
Shown in Non-Arc Enclosure**

**Contactor-Fuse Coordination**

The AMGARD starter provides ensured coordination between its fuses, contactor, current transformers, protective relays, and the motor it is controlling.

One of the most critical coordination issues is between the contactor and the starter fuses. The fuses must interrupt faults greater than the interrupting rating of the contactor. The Ampgard 400 A high interrupting contactor (SL400A-HI) has an 8-cycle dropout time factory setting as standard and will interrupt at 8500 A. The maximum size fuse used with an SL400A-HI contactor is a 450-24R. By comparing the fuse curve with the contactor rating, it can be observed that for faults greater than 8500 A, the fuse will open before the contactor. With faults less than 8500 A, the contactor may clear the fault before the fuse blows, depending on the settings of the protective relays. Refer to **Figure 10.2-1** for an illustration of Ampgard coordination.

Other vacuum contactors available today may have lower interrupting ratings than the Ampgard Type SL vacuum contactors. Dropout times also vary, and may be as short as two cycles on other starter designs. Lower interrupting ratings and shorter dropout times can result in fault current levels where the contactor may be required to interrupt a fault greater than its rating. This can result in equipment failure. Refer to **Figure 10.2-2** for an illustration of an improperly coordinated starter.

Ampgard starters also ensure coordination between other starter components. The current transformers and protective relays are selected to work properly with each other, and to protect the motor. Protective relays like Eaton’s EMR-3000 provide optimal motor protection, while also rapidly opening the contactor during fault conditions. This rapid opening signal cannot open the contactor in less than its set dropout time, but it will take the motor off-line in the shortest possible time.

This will help minimize mechanical damage to the motor and may prevent the starter fuses from blowing by allowing the contactor to clear the fault (only if the fault is less than the contactor interrupting rating).

Ampgard starters use 400 A standard interrupting contactors (SL400-SI) when the contactor is not required to coordinate with the starter main fuse. An example of this application is the run contactor of a reduced voltage starter.

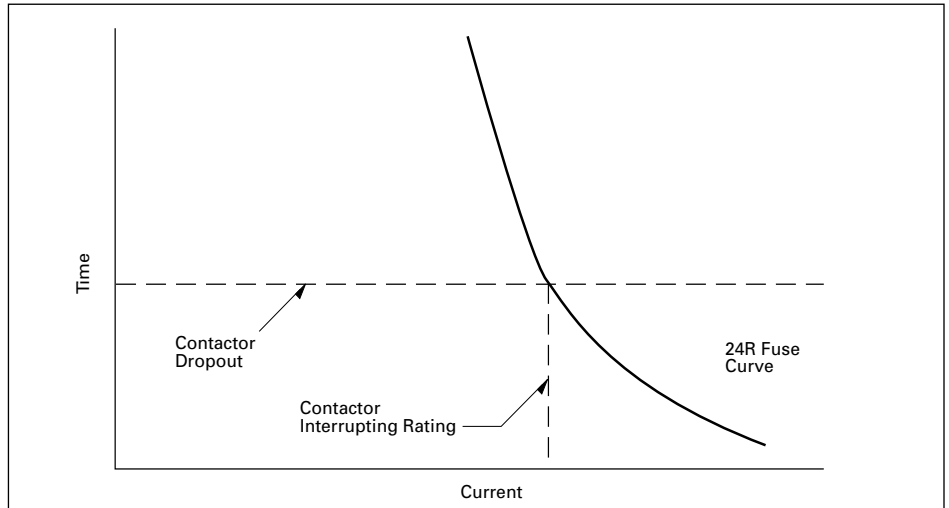

**Figure 10.2-1. Proper Contactor Fuse Coordination Found in Ampgard Starter**

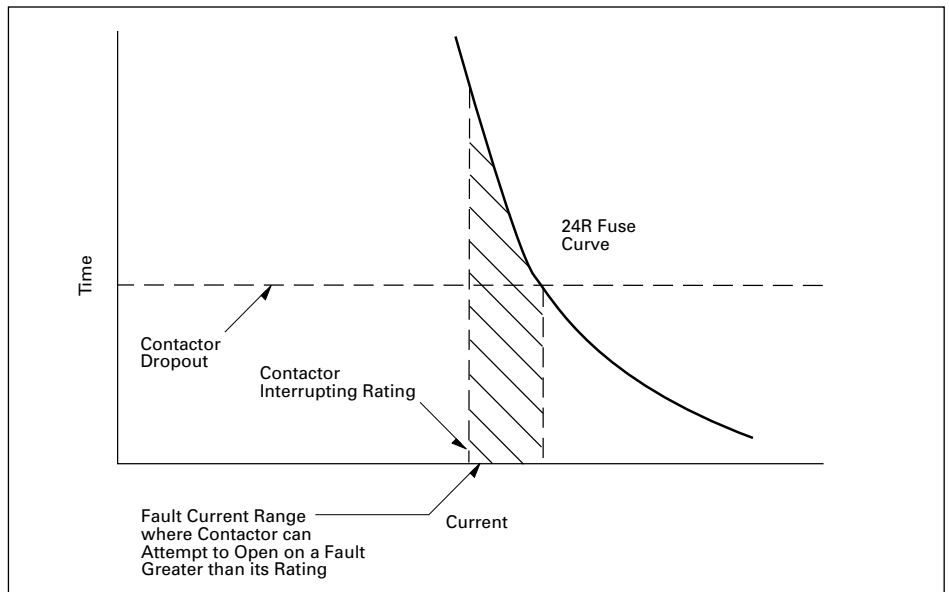

**Figure 10.2-2. Contactor Fuses That Are Not Properly Coordinated**

**Protection Considerations**

Coordinated with the motor's characteristics, the protective devices in the Ampgard starter provide motor protection from overload to full system capacity faults.

Ampgard starters are supplied with an adjustable thermal overload relay as standard.

Multifunction solid-state motor protection relays are a common option on Ampgard starters. The EMR-3000 is typically provided when a multi-function relay is specified. The EMR-3000 provides many types of protection including overload, locked rotor, ground fault and phase loss/phase unbalance. The EMR-3000 also provides start control logic to protect the motor against excessive starting. The relay may be applied to either across-the-line or reduced voltage starters. On reduced voltage starters, the EMR-3000 can control the transition from reduced to full voltage, offering the greatest protection for the motor and starter. An optional RTD module can be supplied for motors with built-in RTDs. The EMR-4000 can be supplied when voltage monitoring and protection are required.



**EMR-3000 Motor Protective Relay**

InsulGard™ relays are an available option on Ampgard starters. The InsulGard provides early warning of increasing partial discharge levels in the starting equipment, cables and motor.

This early warning will help the user to better schedule maintenance and avoid unplanned downtime.

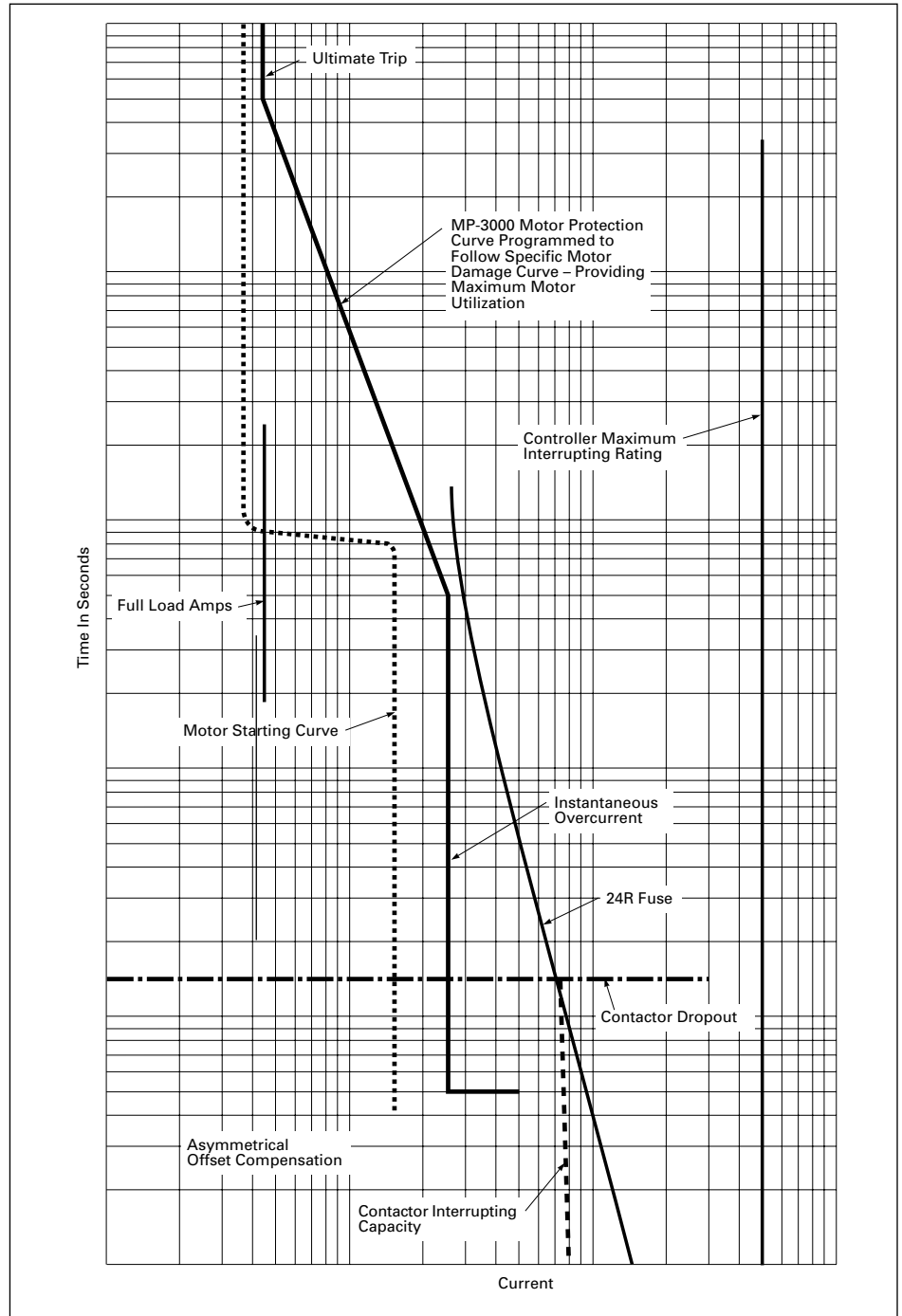

**Figure 10.2-3. Full Range Coordinated Protection Between Current Limiting Type CLS Fuses, Vacuum Contactor and Motor Protection Relay**

## Starter Types

### Full Voltage Starters

Eaton offers full voltage starters in single-high and two-high configurations to satisfy your most rigorous motor starting applications. The full voltage starter provides the most compact and cost-effective means for starting and stopping your motors and is available in single-speed and two-speed applications.

#### Ratings

- 2400–13,800 V
- Up to 8000 hp or 750 FLA
- NEMA 1, 12, 3R and arc-resistant enclosure ratings

#### Optional Features

- Main breaker
- Two-speed one winding and two-speed two winding
- Latched contactor option for transformer feeders

#### Industry Standards

- NEMA ICS3
- UL 347
- CSA
- EEMAC E14-1
- IEEE C37.20.7-2007
- Manufactured in ISO® 9001 and ISO 14001 certified facility

### Reduced Voltage Starters

Eaton offers traditional electro-mechanical reduced voltage starters in addition to reduced voltage solid-state (RVSS) starters. Unless otherwise specified, reactors and autotransformers are NEMA medium duty rated. They are designed for three 30-second starts per hour. Heavy-duty reactors and transformers can be supplied when specified. Locked rotor current must be specified when ordering reduced voltage starters to ensure that the reactors or autotransformers are properly sized.

### Reduced Voltage Reactor Starter



*Reactor Starter  
Shown in Non-Arc Enclosure*

**Table 10.2-1. Type 502 Reactor Starting Characteristics**

Starter Type	% Motor Voltage	% Motor Current	% Line Current	% Torque
80% tap	80	80	80	64
65% tap ①	65	65	65	42
50% tap	50	50	50	25

① Factory set on 65% tap.

#### Advantages

- Reduces starting currents
- Least costly reduced voltage starting method

#### Disadvantages

- Large footprint: 1-1/2 structures at 400 A
- “Bump” on transition to full voltage
- Not as efficient as autotransformer
- Due to reduced torque during starting, motor must typically be unloaded during the start sequence

#### Sequence of Operation

- Main contactor (M) closes
- Current flows through reactor reducing voltage to motor (based on tap setting)
- When motor current reaches ~125%, the run contactor (R) closes providing full voltage to the motor

### Reduced Voltage Autotransformer Starter



*Auto Transformer Starter  
Shown in Non-Arc Enclosure*

**Table 10.2-2. Type 602 Auto Transformer Starting Characteristics**

Starter Type	% Motor Voltage	% Motor Current	% Line Current	% Torque
80% tap	80	80	67	64
65% tap ②	65	65	45	42
50% tap	50	50	28	25

② Factory set on 65% tap.

#### Advantages

- Produces the most torque per incoming line ampere of any reduced voltage starting method
- Less costly than RVSS

#### Disadvantages

- Large footprint: 1-1/2 structures at 400 A
- More costly than reactor
- “Bump” on transition to full voltage
- Due to reduced torque during starting, motor must typically be unloaded during the start sequence

**Note:** Care should be taken when selecting the motor for reduced voltage starting to ensure that there is sufficient torque to accelerate the load at reduced voltage. Motors that do not fully accelerate at reduced voltage will generate high voltages at transition that can damage the autotransformer and void the factory warranty.

#### Sequence of Operation

- Shorting contactor (S) closes
- Main contactor (M) closes
- Current flows through autotransformer reducing voltage to motor (based on tap setting)
- When motor current reaches ~125%, the shorting contactor (S) opens and the run contactor (R) closes providing full voltage to the motor

**Note:** Because the motor is never disconnected from the supply voltage, the starting is closed transition.



**Solid-State Reduced Voltage  
Ampgard MV4S**

Eaton offers arc resistant reduced voltage solid-state starters in ratings up to 400 A at 4160V. Horsepower ratings are available through 2500 hp. The Ampgard MV4S requires one full height structure with a full voltage starter in the upper compartment bus connected to a soft start truck assembly in the lower compartment. The soft starter includes internal fault protection and motor protection. The assembly includes an EMR-3000 relay or other optional motor protective device. For horsepower ratings above 2500 hp, contact Eaton.

**Why is Solid-State Reduced Voltage  
“Soft” Starting Desirable?**

- Eliminate shock to your mechanical components
- Avoid coupling and shaft damage
- Prevent rotor and winding failure
- Stop drive belt squeal and breakage
- Prevent water hammer in pipes
- Soft stop the pump motors
- Reduce pressure so valves close gently
- Avoid the surge wave
- Reduce peak starting currents
- Reduce voltage drop on motor start

**Ratings**

- 2300–4160 Vac
- 60 kV BIL impulse rating
- Horsepower: to 5000 hp or 720 A

Refer to **Table 10.2-12 on Page 10.2-22** for more detailed ratings information.

**Industry Standards**

The Ampgard MV4S solid-state starter is designed and built to meet all applicable industry standards. The 400 A starter is available as a UL listed assembly.

- NEMA ICS3
- UL 347
- CSA
- IEEE C37.20.7-2007
- Manufactured in an ISO 9001 and ISO 14001 certified facility

**Starting Characteristics**

The soft start controller provides a number of selectable starting characteristics as standard:

**Kick Start**

Provides an initial boost of current to overcome motor and system inertia. Range 0.1 to 2 seconds at 10–100% voltage.

**Ramp Start**

Operator sets the initial starting voltage and ramp time. Factory setting for starting voltage is 20%. Range is 0 to 100%. Factory setting for starting time is 10 seconds. Range is 1 to 120 seconds.

**Current Limit**

Limits the maximum starting current. Used in long start time applications and motor protection applications. Factory setting is 350% of motor FLA. Range is 200 to 600%.

**Solid-State Soft Stop**

Provides a slow decrease in output voltage. Extends the stopping time of the motor. Typically used with pumps.

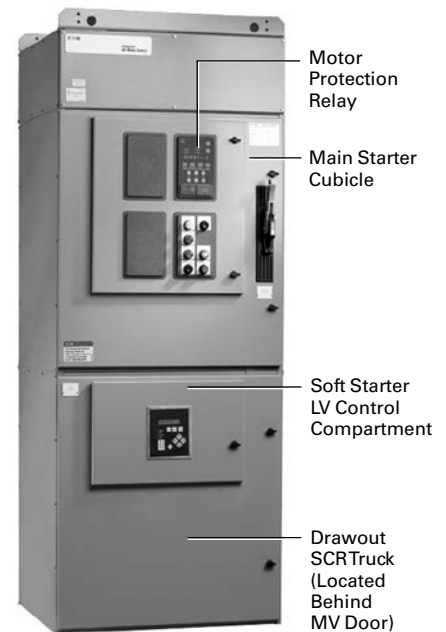

**Ampgard 400A Soft Starter  
Shown in Non-Arc Enclosure**



**Load Cables—Normal**



**Load Cables—Moved for Full Voltage Start**

**Table 10.2-3. MV4S Specifications**

Description	Specification	
Type of load	Three-phase medium-voltage ac induction or synchronous motors	
ac supply voltage	2300, 3300, 4160 Vac +10% to -15%, 50/60 Hz line voltages	
hp ratings	Up to 2500 hp at 4160 V (360 A)	
Overload rating	AC-53b (600-30-60m) (500% 60 sec; 600% 30 sec)	
Power circuit	Highest rated series SCRs available	
SCR peak inverse voltage	<b>Line voltage</b>	<b>PIV rating</b>
	2300	6500
	3300	9000
	4160	13,000
BIL rating	2300–4160 V: 60 kV; corona-free design	
Transient voltage protection	Standard on all models	
Vacuum Bypass Contactor	In-line and bypass standard on all models	
Ambient operating conditions	0 to 40 °C (32 °F to 104 °F) (optional -20 °C to +50 °C with heaters) 5 to 95% relative humidity 0 to 3300 ft (1000 m above sea level without derating)	
Operator interface panel (HMI)	Programmable keypad/operator with 2 lines x 20 character backlit LCD Plain text display Status/Alarm LEDs (indicate: Power, Run, Alarm, Trip, Aux 1–8)	
Available I/O	Dedicated E-Stop circuit Multiple Form C contacts rated 5 A at 250 Vac maximum 8 fully programmable Relays (4 customer definable) Fail safe operation 5 dedicated relays (fault, at-speed, etc.) 2 analog outputs	
Acceleration control	Voltage ramp, voltage ramp with current limit, power (kW) ramp, current ramp, current limit, or custom ramp, tach feedback closed loop speed ramp optional, dual ramp, kick start, jog	
Deceleration control	Pump-flex decel control standard on all models	
Motor and starter protection	Electronic overload (49) Instantaneous overcurrent (50) ac time overcurrent (51) Undercurrent (37) Current imbalance (46) Phase loss (46) Overvoltage (59) Undervoltage (27) Phase rotation (47) Starter over-temp Starts per hour lockout (66) Lockout/Start inhibit (86)	Time between starts (66) shorted SCR Bearing RTD protection (38) optional Stator RTD protection (49) optional Mechanical condition (39) optional Instantaneous overcurrent (50) ac time overcurrent (51) Ground fault (option) incomplete sequence (48) Power factor trip (55) Differential (87 M) optional Ground fault (50N/51N, 50G/51G) Rate of rise "di/dt" (7)
Statistical data	Fault log up to 60 events (data includes date and time) Elapsed run time, last start time, average starting current Time-to-trip, remaining inhibit time and starts/hour values	
Metering (voltage and current)	Percent of FLA, phase currents, kvar, kVA, kW, power factor, demand, avg. start current, remaining thermal register, thermal capacity to start, measured capacity to start, time since last start, line frequency, phase order, RTD values (optional)	
Commissioning software	Free MV4SLink-based programming software	
Communications	RS-485 with Modbus® RTU protocol or RS-232 with Windows® interface Optional DeviceNet™, PROFIBUS®, Ethernet Modbus/TCP, EtherNet/IP Optional Web Server Remote Monitoring Optional EZ-SCADA communications	



**MV4S Keypad and Display**

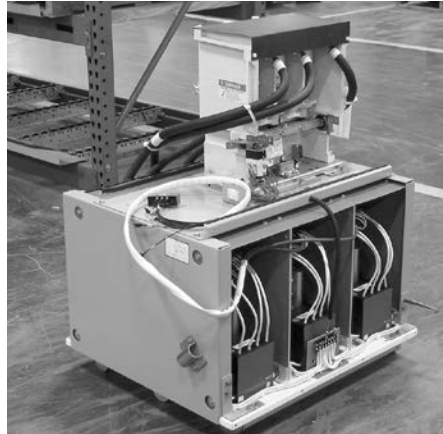

**400 A MV4S Roll-out Truck**

### Application with Capacitors

Capacitors of any kind may not be connected to the load of the solid-state starter. When power factor correction capacitors are required, the capacitors are connected ahead of the RVSS truck and are switched with a separate capacitor contactor. If multiple starters with capacitors are supplied in the same lineup, capacitors are prevented from switching while solid-state starter ramps. Long cable runs may create enough capacitance to be of concern. Capacitance connected to the starter motor connections must not exceed 0.3 uF, typically 750 feet or 350 feet of two cable runs per phase. Power factor capacitors or surge capacitors must not be connected at the motor.

**Note:** Contact Eaton for output capacitance or cable lengths that exceed the recommended values.

### Design

Soft start components and bypass contactor are mounted in a easy-to-remove roll-out truck assembly. Maintenance can be performed with the truck on a bench away from the starter cubicle.

An option is available that allows the internal bypass contactor can be manually closed for emergency full voltage start operation.

### How It Works

1. At the time of start, the bypass contactor is open and all current passes through the SCRs that ramp the voltage per the pre-programmed starter settings.
2. After start is complete, the bypass contactor closes, taking the SCRs out of the circuit.
3. The SCRs are on for only a short time therefore no MCC venting or cooling is required.
4. When a stop command is received, the SCRs can be programmed to ramp down, providing a soft stop.

## Standard Ratings

**Table 10.2-4. Starter Maximum Continuous Current Ratings**

Starter Class	Enclosure Type
	Arc Resistant
Two-high with 400 A 7.2 kV contactors	320 top
	320 bottom
Two-high with 400 A 7.2 kV contactors—alternate	210 top
	350 bottom
One-high with 800 A 7.2 kV contactor	600/750 ①

① Limited acceleration time and locked rotor current. Contact Eaton for details.

## Type SL, 400 A, 7.2 kV Vacuum Contactor/Starter Ratings

**Table 10.2-5. Type SL 400 A Vacuum Contactor Ratings**

Rated Utilization Voltage	2200 to 2500V	3000 to 3600V	3800 to 4800V	6000 to 7200 V
Interrupting rating (With 400 A high interrupting contactor) NEMA unfused (E1) NEMA fused (E2)	8.5 kA 50 kA	8.5 kA 50 kA	8.5 kA 50 kA	8.5 kA 50 kA
Application table Induction motor Synchronous motor (0.8 PF) (1.0 PF) Transformer ② Capacitor three-phase	200 MVA at 2400 V 1750 hp 1750 hp 2000 hp 1500 kVA 1200 kvar	285 MVA at 3300 V 2250 hp 2250 hp 2500 hp 2000 kVA 1650 kvar	400 MVA at 4600 V 3000 hp 3000 hp 3500 hp 2250 kVA 2100 kvar	570 MVA at 6600 V 4500 hp 4500 hp 5500 hp 4000 kVA 3300 kvar

### Maximum Insulation Voltage: 7200 V

Maximum interrupting current (3 operations)	8500 A (High interrupting) 4500 A (Standard interrupting) 400 A enclosed	Arcing time Pickup voltage Dropout voltage Control voltages ac dc Control circuit burden Closing (ac)/(dc) Holding (ac)/(dc)	12 milliseconds (3/4 cycle) or less 80% rated coil voltage 60% rated coil voltage
Rated current IEC make-break capability-AC4 Make Break	4000 A 3200 A	Auxiliary contact rating Voltage (maximum) Continuous current Making capacity (ac) Making capacity (dc) Breaking capacity (ac) Breaking capacity (dc)	110/120/220/240 (50/60 Hz) 125
Short-time current 30 seconds 1 second 8.7 milliseconds (0.5 cycle) ③	2400 A 6000 A 63 kA peak	Latch (when specified) Mechanical life Trip voltages (dc) Trip voltages (ac)	100 V–125 V, 1 kVA/200–250 V, 1.8 kVA 100 V–125 V, 40 VA/200–250 V, 50 VA
Standard service altitude Optional service altitudes	–1000 to +2000 meters –3500 to –1001 meters +2001 to +5000 meters	Minimum trip voltage Trip burden 24 Vdc 125 Vdc 110/120 Vac Trip time Weight	600 V 10 A 7200 VA 125 VA 720 VA 125 VA
Mechanical life Electrical life BIL Dielectric strength (60 Hz) Closing time (Energization to contact touch) Opening time	2.5 million operations 300,000 operations 60 kV (1.2 x 50 microseconds) 20 kV (1 minute) 80 milliseconds 30 to 330 milliseconds (selectable)		250,000 operations 24/125 V 110/120 V 80% rated coil voltage 400 VA 400 VA 400 VA 30 milliseconds 60 lb (27 kg) (stab-in/bolt-in)

② Higher ratings possible depending on transformer magnetizing current. Contact Eaton for more information.

③ Time stated in cycles on 60 Hz base.

**Type SL, 800 A, 7.2 kV Vacuum Contactor/Starter Ratings**

**Table 10.2-6. Type SL 800 A Vacuum Contactor Ratings**

Description	SL 25V830	SL 33V830	SL 50V830	SL 72V830
Rated utilization voltage	2200–2500 V	3000–3300 V	3800–5000 V	6000–7200 V
Interrupting rating NEMA unfused (E1) NEMA fused (E2) NEMA fused (E2)	12.5 kA 200 MVA at 2300 V 50 kA	12.5 kA 285 MVA at 3300 V 50 kA	12.5 kA 408 MVA at 4600 V 50 kA	12.5 kA 570 MVA at 6600 V 50 kA
Power rating ① Induction motor Synchronous motor (0.8 PF) (1.0 PF) Transformer Capacitor three-phase	3000 hp 3000 hp 3500 hp 2500 kVA 2400 kvar	4000 hp 4000 hp 5000 hp 3500 kVA 3200 kvar	5000 hp 5000 hp 6000 hp 4500 kVA 4000 kvar	8000 hp 8000 hp 10,000 hp 6000 kVA 4800 kvar

**Maximum Insulation Voltage: 7200 V**

Maximum interrupting current (three operations) Rated current	12,500 A 600/650/720 A enclosed 800 A open	Arcing time Pickup voltage Dropout voltage Control voltages (ac)/(dc)	12 milliseconds (3/4 cycle) or less 80% rated coil voltage 60% rated coil voltage 110/120/220/240 V (50/60 Hz) 125 Vdc
IEC make-break capability-AC4 class 3 Make Break	8000 A 6400 A	Control circuit burden (rated volt) Closing (ac)/(dc) Holding (ac)/(dc)	2600 VA 80 VA
Short time current 30 seconds 1 second 8.75 milliseconds (0.5 cycle)	4320 A 10,800 A 86 kA peak	Auxiliary contact rating (L-64) Voltage (maximum) Continuous current	600 V 10 A
Mechanical life Electrical life	250,000 operations 200,000 operations At rated current	Making capacity (ac) Making capacity (dc) Breaking capacity (ac) Breaking capacity (dc)	7200 VA 200 VA 720 VA 200 VA
BIL Dielectric strength (60 Hz) Closing time (energization to contact touch) Opening time	60 kV (1.2 x 50 microseconds) 18.2 kV (1 minute) 80 milliseconds 50–330 milliseconds, field selectable	Latch (when specified) Mechanical life Trip voltages (dc) Trip voltages (ac) Tripping voltage Tripping burden 24 Vdc 48 Vdc and 96 Vdc 110 Vac and 220 Vac Weight	100,000 operations 24/48/96 V 110/220 V (50/60 Hz) 80% rated coil voltage  1200 VA 400 VA 500 VA 95 lb (43 kg)

① Other power ratings are available based on the specific load data.

## Isolation Switch

### Mechanical Non-Loadbreak Isolating Switch

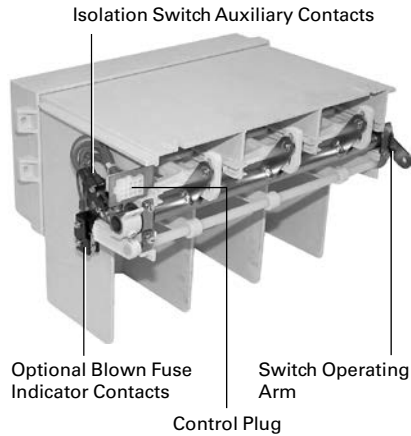

**JMT-400/800 A Isolation Switch  
Front View**

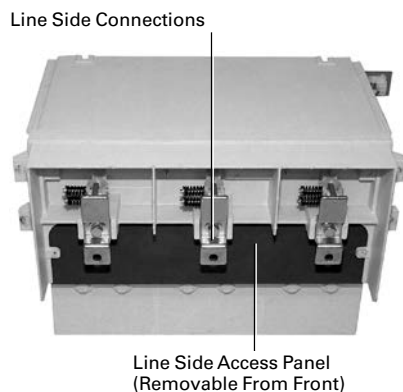

**JMT-400/800 A Isolation Switch  
Rear View**

### General Description

Eaton's Type JMT-4/8 is a drawout, lightweight, three-pole, manually operated isolating switch mounted in the top of the starter enclosure. They may be easily removed by loosening two bolts in the rear of the switch. The JMT-4 is rated 400 A continuous while the JMT-8 is rated 720 A continuous. All isolation switches have a mechanical life rating of 10,000 operations.

The component-to-component circuitry concept includes the mountings for the current limiting fuses as part of the isolating switch.

### Features

A positive mechanical interlock between the isolating switch handle mechanism and contactor prevents the isolating switch from being opened when the contactor is closed or from being closed if the contactor is closed.

An operating lever in the isolating switch handle mechanism is designed to shear off if the operator uses too much force in trying to open the non-loadbreak isolating switch when the contactor is closed. This feature ensures that the operator cannot open the switch with the main contactor closed, even if excessive force is used on the operating handle.

To operate the isolating switch, the operating handle is moved through a 180° vertical swing from the ON to the OFF position. In the ON position, a plunger on the back of the handle housing extends through a bracket on the rear of the starter high-voltage door, preventing the door from being opened with the switch closed. When the high-voltage door is open, a door interlock prevents the handle from being inadvertently returned to the ON position.

When the operating handle is moved from ON to OFF, copper stabs are withdrawn from incoming line fingers. As the stabs withdraw, they are visible above the top of the fuses when viewed from the front, and simultaneously grounded. As the fingers are withdrawn, a spring-driven isolating shutter moves across the back barrier to prevent front access to the line connections. As the shutter slides into position, distinctive markings appear on the back barrier, making it easier to check the position of the shutter.



**Switch Handle  
Closed**



**Switch Handle  
Open**

## Contactors

### 400 A, 7.2 kV Vacuum Contactor, Type SL

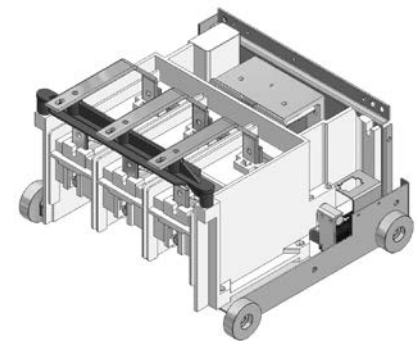

**400 A Bolt-in Contactor  
7200 Volt Maximum**

### General Description

Eaton's Type SL Vacuum Contactors were designed and engineered specifically for use in Ampgard starters. 7.2 kV SL 400 A Vacuum Contactors are self-supporting, compact, drawout, three-pole, dc magnet closed contactors. To permit application matching of the starter to the motor rating, the SL Contactor is available in 400 A standard and high interrupting ratings.

SL Contactors are available in the standard bolt-in configuration and optional stab-in design. Either bolt-in or stab-in designs can be supplied in a two-high configuration, with a starter maximum of 400 full load amperes. The total NEMA 1 structure rating cannot exceed 720 A for a combination of two starters. Refer to **Table 10.2-4 on Page 10.2-12** for other ratings.

### Design

Eaton Vacuum Contactors are highly versatile, low-chop contactors that have been designed to meet all applicable NEMA standards and are UL® recognized components. The contactors accommodate mechanical interlocks that function with the starter isolation switch and with other contactors. These interlocks provide unmatched safety and service protection.

The contactors consist of a molded frame with moving armature, magnet and vacuum interrupters. The contactor is easily positioned into the starter, and vacuum interrupters provide long life with a minimal maintenance program. The SL operating coils are energized by a control board that provides a pulse-width-modulated dc output. Control voltages and contactor dropout times are programmed using a DIP switch located on the control board.

The control board is mounted in a protected cavity in the molded contactor frame to prevent inadvertent access to the voltage and dropout DIP switch. Four auxiliary contacts (2NO, 2NC) are supplied with each contactor and are wired to terminal blocks on the starter control panel.

The vacuum interrupters employ special main contact materials that exhibit a low chop current plus other specially engineered characteristics that minimize switching surges. Surge protection is therefore not required due to the use of the vacuum contactor. Surge protection may be required for other reasons such as the high probability of lightning strike, etc.

**Supplemental Devices**

A lift device is available to assist in withdrawal, removal and installation of medium-voltage breaker or contactor.

**Maintenance**

Reduced maintenance is one of the outstanding features of Eaton's Vacuum Contactor line. The special contact material in the vacuum interrupters provides long life even under severe operating conditions. The main coils operate with a very low temperature rise to maximize insulation life. Steel bearings on the main shaft provide long, trouble-free operation.

An included simple go/no-go gauge is used for checking contact wear. Wear can be checked without removing the contactor from the starter. The vacuum contactor at 60 lb is much lighter than previous generation airbreak or vacuum contactors, which allows for easier insertion and removal from the starter structure.

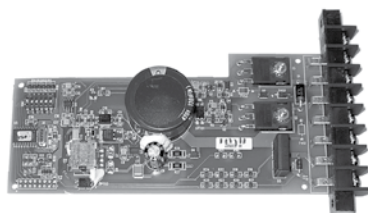

**Contactor Control Board**

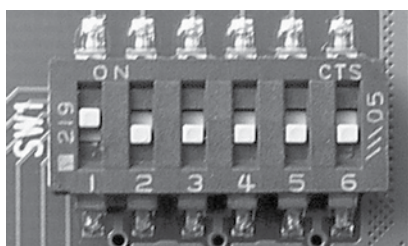

**DIP Switch on Contactor Control Board**

**400 A, 7.2 kV Bolt-in**

The bolt-in version of the SL Contactor is supplied as standard for those applications requiring a 400 A contactor. The contactor is mounted on wheels and rolls into the Ampgard structure on steel rails. Bolted bus bars connect the contactor line and load terminals to the power components in the starter cell. A three-phase current transformer, three-phase potential transformer and ground fault current transformer are mounted in the cell when required. A plug on the side of the contactor connects the contactor to the low-voltage control panel.

The contactor is easily withdrawn from the structure by removing the six bolts securing the contactor line and load terminals, and the pin connecting the isolating switch interlock arm. The contactor can be removed from the starter without disconnecting any medium-voltage cables.



**400 A Bolt-in Contactor  
7200 V Maximum**

**400 A, 7.2 kV Stab-in**

A stab-in version of the SL Contactor is an available option. The stab-in contactor is mounted on wheels and rolls into the Ampgard structure. Contactor line and load fingers engage cell-mounted stabs as the contactor is inserted into the starter cell. The contactor is held in position by a bolt and bracket combination. It can be easily withdrawn from the starter cell by removing the bolt holding the contactor against the bracket and disconnecting the isolation switch interlock. The contactor can be removed from the starter without disconnecting any medium-voltage cables.

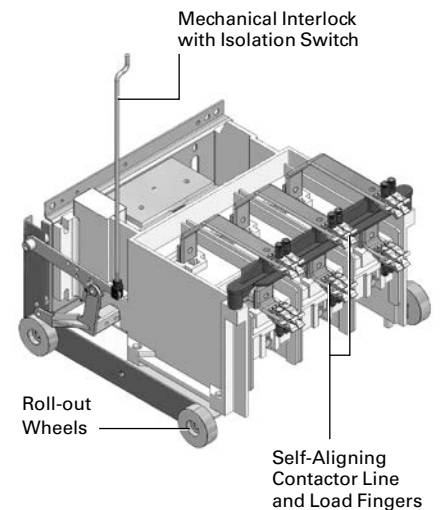

**400 A Stab-in Contactor 7200 V  
Maximum with Mechanical Interlock**

**800 A, 7.2 kV Vacuum Contactors**

The 800 A SL Contactor is available in a one-high configuration and is rated at 600/650/750 A enclosed. The 800 A contactor is available with a stab-in or bolt-in type connection. The 800 A contactor is mounted on wheels and has similar features to the stab-in 400 A contactor.



**800 A Vacuum Break Contactor  
7200 V Maximum Stab-in with Wheels,  
and Line and Load Fingers**

## Current Limiting Fuses

Ampgard starters use Eaton's Type CLS power fuses with special time/current characteristics for motor service. Type CLE or Type HLE power fuses are applied when the starter is used to feed a transformer. The fuse is coordinated with the contactor and overload relay characteristics to provide maximum motor/transformer utilization and protection. The only mounting method for power fuses is bolted for arc resistant contactors.

Interruption is accomplished without expulsion of gases, noise or moving parts. Type CLS/CLE/HLE fuses are mounted in a vertical position to ensure maximum rating reliability, proper operation and to eliminate the possibility of dust and dirt collecting, resulting in a deterioration of dielectric properties. When a fault has been cleared, a plastic indicator in the top of the fuse, normally depressed, pops up to give visible blown fuse indication. This indicator also operates the optional blown fuse mechanism on the isolation switch that gives a contact closure to allow use in the starter control circuit.

Blown fuses may be removed and replaced without removing or drawing out the contactor. The control circuit primary fuses are also current limiting.



CLS Bolted Fuse

**Standard Fuse Mounting is Bolted**



Blown Fuse Indicator  
Operating Arm (Optional)      Fuse Fault Indicator

**Blown Fuse Indicating Device**

## Incoming Line

Depending on the size and number of incoming cables, an incoming line enclosure may be necessary. Different designs are available for incoming power for top or bottom entry.

When incoming line metering is specified, an additional 24-inch (610 mm) wide metering structure is typically supplied.

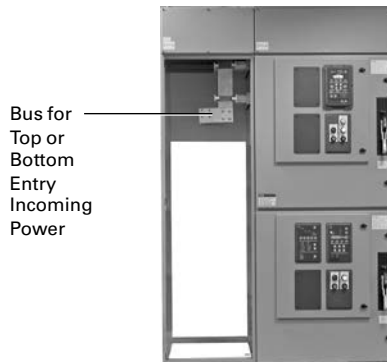

**Typical 24-Inch (610 mm) Wide  
Incoming Line Structure  
Shown in Non-Arc Enclosure**

## Incoming Line Connection Options

- Cable: Maximum of six per phase, 750 kcmil maximum, top or bottom entry
- Bus connected Eaton medium-voltage switchgear

## Potential Transformers, Control Power Transformer Disconnect and Fuses

Bus connected potential transformers and/or control power transformers are mounted in a 40-inch (1016 mm) high assembly that includes a disconnect and primary fuses.

## Microprocessor-Based Relays

Eaton's protective relays provide programmable circuit protection, information and operator conducted testing.

## Metering

Power Xpert® meters are available for multi-function metering.

## Communications

Eaton's Power Xpert Architecture communications provides for monitoring and controlling complete electrical distribution systems of those parts of a system selected by the operator.

## Accessories

### Remote Operator

A remote operator for the starter isolation switch is an available option. The Ampgard Remote Operator (ARO) enables users to open or close the switch through the use of a pushbutton station operated up to 30 feet away from the starter. Users can mount the ARO on the front of the starter, plug it into any available 120 Vac source, then easily operate the isolation switch from outside the starter arc flash boundary.



**Ampgard Remote Operator**



## Full Voltage

### Full Voltage Squirrel Cage Starters Catalog S210 Non-Reversing Catalog S310 Reversing

#### Equipment Details

##### Mounted in the Medium-Voltage Section

- Three incoming line connectors
- Drawout three-pole gang-operated line isolating switch assembly with isolating shutter, external operating handle interlocked to prevent opening the medium-voltage compartment door until the isolating switch is open and grounded
- Vertically mounted current limiting power fuses with pop-up blown fuse indicators
- One magnetic three-pole vacuum contactor with dc operating coils and mechanical interlock to prevent opening the isolating switch when contactor is closed
- One control power transformer (115V secondary)
- Two CPT primary current limiting fuses
- Four electrical interlocks (2NO, 2NC)
- Three current transformers

##### Reversing Starter

One additional magnetic three-pole vacuum contactor (duplicate of above), both contactors are mechanically and electrically interlocked.

##### Mounted in the Low-Voltage Compartment

- Control panel with:
  - One EMR-3000 motor protection relay
  - One interposing control relay
- Set of control circuit terminal blocks
  - One control circuit secondary fuse
  - One run-test circuit

## Specifications

Table 10.2-7. Starter Selection Information—Dimensions in Inches (mm)  
Dimensions for estimating purposes only.

Horsepower ①	Volts	Contactor Ampere Rating (Enclosed)	Starter Interrupting Rating (kVA)	Equipment Arrangement Number	Dimensions			Additional Starter Spaces	Weight Lb (kg)
					Height ②	Width	Depth		
<b>2200–2400 V Non-Reversing</b>									
700/800 ③	2300	400	200,000	1	127 (3226)	36 (914)	50 (1270)	1 ⑤	1350 (613)
1500/1750 ④	2300	400	200,000	1	127 (3226)	36 (914)	50 (1270)	1 ⑤	1350 (613)
3000	2300	720	200,000	2	127 (3226)	36 (914)	50 (1270)	0	1700 (772)
<b>2200–2400 V Reversing</b>									
700/800 ③	2300	400	200,000	3	127 (3226)	36 (914)	50 (1270)	0	1800 (817)
1500/1750 ④	2300	400	200,000	3	127 (3226)	36 (914)	50 (1270)	0	1800 (817)
3000	2300	720	200,000	4	127 (3226)	36 (914)	50 (1270)	0	2400 (1090)
<b>4000–4800 V Non-Reversing</b>									
1250/1500 ③	4600	400	400,000	1	127 (3226)	36 (914)	50 (1270)	1 ⑤	1350 (613)
2500/3000 ④	4600	400	400,000	1	127 (3226)	36 (914)	50 (1270)	1 ⑤	1350 (613)
5500	4600	720	400,000	2	127 (3226)	36 (914)	50 (1270)	0	1700 (772)
<b>4000–4800 V Reversing</b>									
1250/1500 ③	4600	400	400,000	3	127 (3226)	36 (914)	50 (1270)	0	1800 (817)
2500/3000 ④	4600	400	400,000	3	127 (3226)	36 (914)	50 (1270)	0	1800 (817)
5500	4600	720	400,000	4	127 (3226)	36 (914)	50 (1270)	0	2400 (1090)
<b>6600 V Non-Reversing</b>									
2000/2250 ③	6600 ⑥	400	570,000	1	127 (3226)	36 (914)	50 (1270)	1 ⑤	1500 (681)
4000/4500 ④	6600 ⑥	400	570,000	1	127 (3226)	36 (914)	50 (1270)	1 ⑤	1500 (681)
8000	6600 ⑥	720	570,000	2	127 (3226)	36 (914)	50 (1270)	0	1800 (817)
<b>6600 V Reversing</b>									
2000/2250 ③	6600 ⑥	400	570,000	3	127 (3226)	36 (914)	50 (1270)	0	1800 (817)
4000/4500 ④	6600 ⑥	400	570,000	3	127 (3226)	36 (914)	50 (1270)	0	1800 (817)
8000	6600 ⑥	720	570,000	4	127 (3226)	36 (914)	50 (1270)	0	2400 (1090)

① Horsepower based on NEMA standard design B motor at 1800 rpm.

② Includes Plenum.

③ At higher hp rating, maximum acceleration time is 3.5 seconds.

④ At higher hp rating, maximum acceleration time is 6 seconds.

⑤ Maximum current for two starters in a single structure is 720 A.

⑥ May be applied on 6900 V systems where maximum voltage does not exceed 7200 V.

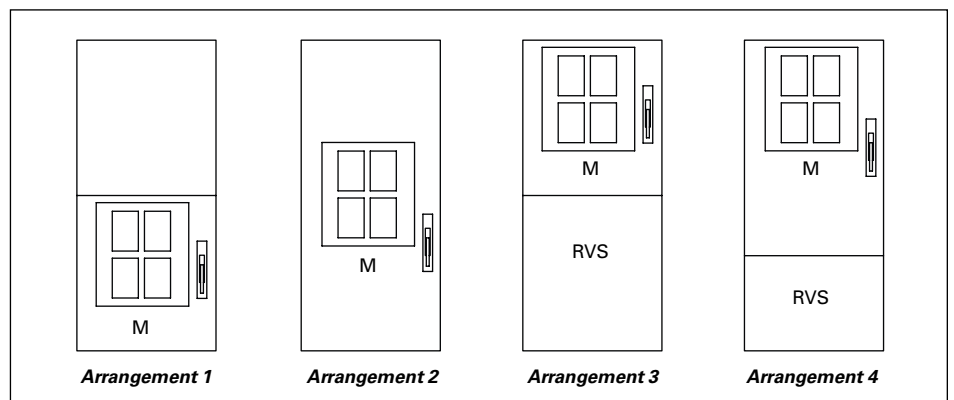

Figure 10.2-4. Starter Arrangements

## Reactor

### Primary Reactor, Reduced Voltage Starters Catalog S510 Non-Reversing Catalog S710 Reversing

#### Mounted in the Medium-Voltage Section

- Three incoming line connectors
- One drawout three-pole gang-operated line isolation switch assembly with isolating shutter, external operating handle interlocked to prevent opening the medium-voltage compartment door until the isolating switch is open and grounded
- One vertically mounted current limiting power fuse with pop-up blown fuse indicators
- One magnetic three-pole vacuum contactor with dc operating coils and mechanical interlock to prevent opening the isolation switch when the contactor is closed
- One control power transformer (115 V secondary)
- Two CPT primary current limiting fuses
- Four electrical interlocks (2NO, 2NC)

#### Reversing Starter

One additional magnetic contactor (duplicate of above), both contactors are mechanically and electrically interlocked.

#### Mounted in the Low-Voltage Compartment

- One control panel with:
  - One EMR-3000 motor protection relay
  - Two interposing relays
- One set of control circuit terminal blocks
  - One control circuit secondary fuse
  - One run-test circuit

#### Reduced Voltage Structure

- One magnetic three-pole vacuum run contactor with dc operating coil and electrical interlocks
- Three current transformers
- One medium-duty starting reactor with 50–65–80% taps

#### Locked Rotor Amps

- Locked Rotor Amps (LRA) must be specified to ensure proper sizing of reactor

## Starting Characteristics

Table 10.2-8. Type 502 Reactor Starting Characteristics

Starter Type	% Motor Voltage	% Motor Current	% Line Current	% Torque
80% tap	80	80	80	64
65% tap ①	65	65	65	42
50% tap	50	50	50	25

① Factory set on 65% tap.

## Specifications

Table 10.2-9. Starter Selection Information—Dimensions in Inches (mm)  
Dimensions for estimating purposes only.

Horsepower ②	Volts	Contactor Ampere Rating (Enclosed)	Starter Interrupting Rating (kVA)	Equipment Arrangement Number	Dimensions			Weight Lb (kg)
					Height ③	Width	Depth	

#### 2200–2400 V Non-Reversing

700/800 ④	2300	400	200,000	1	127 (3236)	72 (1829)	30 (762)	2800 (1271)
1500/1750 ⑤	2300	400	200,000	1	127 (3236)	72 (1829)	30 (762)	2800 (1271)

#### 2200–2400 V Reversing

700/800 ④	2300	400	200,000	3	127 (3236)	72 (1829)	30 (762)	3250 (1476)
1500/1750 ⑤	2300	400	200,000	3	127 (3236)	72 (1829)	30 (762)	3250 (1476)

#### 4000–4800 V Non-Reversing

1250/1500 ④	4600	400	400,000	1	127 (3236)	72 (1829)	30 (762)	2800 (1271)
2500/3000 ⑤	4600	400	400,000	1	127 (3236)	72 (1829)	30 (762)	2800 (1271)

#### 4000–4800 V Reversing

1250/1500 ④	4600	400	400,000	3	127 (3236)	72 (1829)	30 (762)	3250 (1476)
2500/3000 ⑤	4600	400	400,000	3	127 (3236)	72 (1829)	30 (762)	3250 (1476)

#### 6600 V Non-Reversing

2000/2250 ④	6600	400	570,000	1	127 (3236)	72 (1829)	30 (762)	3300 (1498)
4000/4500 ⑤	6600	400	570,000	1	127 (3236)	72 (1829)	30 (762)	3300 (1498)

#### 6600 V Reversing

2000/2250 ④	6600	400	570,000	3	127 (3236)	72 (1829)	30 (762)	3250 (1476)
4000/4500 ⑤	6600	400	570,000	3	127 (3236)	72 (1829)	30 (762)	3250 (1476)

② Horsepower based on NEMA standard design B motor at 1800 rpm.

③ When horizontal bus is added, height becomes 92.00 inches (2336.8 mm).

④ At higher hp rating maximum acceleration time is 3.5 seconds.

⑤ At higher hp rating maximum acceleration time is 6 seconds.

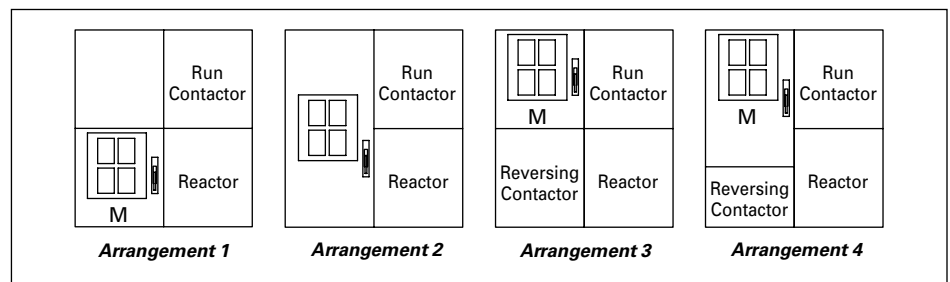

Figure 10.2-5. Starter Arrangements

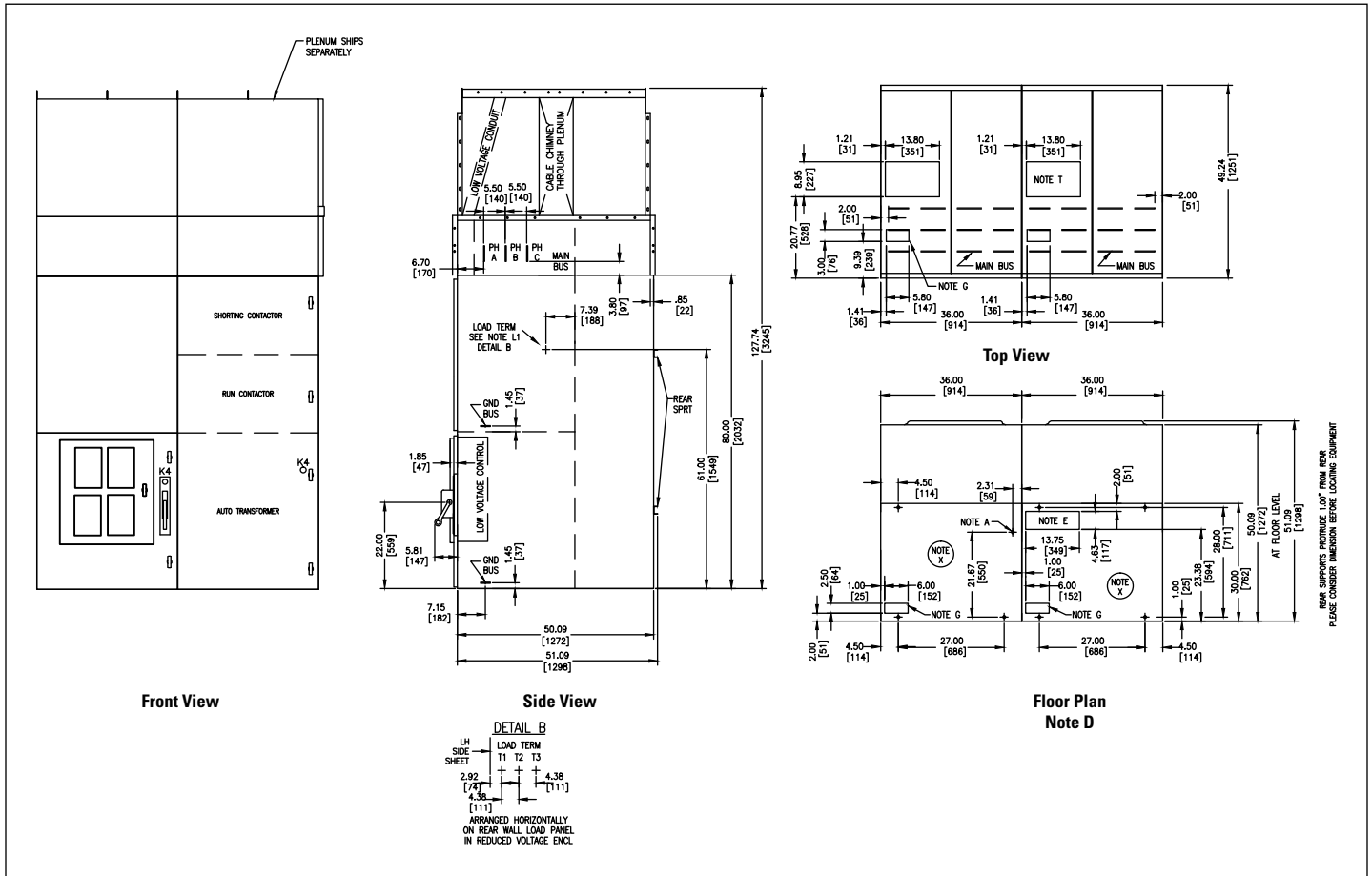

Figure 10.2-6. Arrangement 1 Detail (Reduced Voltage, 400 A)—Dimensions in Inches (mm)—See Table 10.2-13 on Page 10.2-24 for Notes (this outline applies to both reactor and autotransformer type starters)

## Autotransformer

### Reduced Voltage Autotransformer Starters Catalog S610 Non-Reversing Catalog S810 Reversing

#### Mounted in the Medium-Voltage Section

- Three incoming line connectors
- One drawout three-pole gang-operated line isolation switch assembly with isolating shutter, external operating handle interlocked to prevent opening the medium-voltage compartment door until the isolating switch is open and grounded
- Three vertically mounted current limiting power fuses with pop-up blown fuse indicators
- One magnetic three-pole vacuum contactor with dc operating coils and mechanical interlock to prevent opening the isolation switch when the contactor is closed
- One control power transformer (115 V secondary)
- Two CPT primary current limiting fuses
- Four electrical interlocks (2NO, 2NC)

#### Reversing Starter

One additional magnetic contactor (duplicate of above), both contactors are mechanically and electrically interlocked.

#### Mounted in the Low-Voltage Compartment

- One control panel with:
  - One EMR-3000 motor protection relay
  - Three interposing relays
- One set of control circuit terminal blocks
  - One control circuit secondary fuse
  - One run-test circuit

#### Reduced Voltage Structure(s)

- One magnetic three-pole vacuum run contactor with dc operating coil and electrically and mechanically interlocked with the starting contactor
- One magnetic two-pole vacuum start contactor with dc operating coil and electrical and mechanical interlocks
- Three current transformers
- One medium-duty starting auto-transformer with 50–65–80% taps
- Three distribution class lightning arresters for high-voltage stress protection on the transformer zero tap

#### Locked Rotor Amps

- Locked Rotor Amps (LRA) must be specified to ensure proper sizing of autotransformer

#### Starting Characteristics

**Table 10.2-10. Type 602 Auto-transformer Starting Characteristics**

Starter Type	% Motor Voltage	% Motor Current	% Line Current	% Torque
80% tap	80	80	67	64
65% tap ①	65	65	45	42
50% tap	50	50	28	25

① Factory set on 65% tap.

**Specifications**

**Table 10.2-11. Starter Selection Information—Dimensions in Inches (mm)**  
Dimensions for estimating purposes only.

Horsepower ②	Volts	Contactor Ampere Rating (Enclosed)	Starter Interrupting Rating (kVA)	Equipment Arrangement Number	Dimensions			Number of Structures	Weight Lb (kg)
					Height ③	Width	Depth		
<b>2200–2400 V Non-Reversing</b>									
700/800 ④	2300	400	200,000	1	127 (3226)	72 (1829)	50 (1270)	2	3100 (1407)
1500/1750 ⑤	2300	400	200,000	1	127 (3226)	72 (1829)	50 (1270)	2	3100 (1407)
<b>2200–2400 V Reversing</b>									
700/800 ④	2300	400	200,000	3	127 (3226)	72 (1829)	50 (1270)	2	3650 (1657)
1500/1750 ⑤	2300	400	200,000	3	127 (3226)	72 (1829)	50 (1270)	2	3650 (1657)
<b>4000–4800 V Non-Reversing</b>									
1250/1500 ④	4600	400	400,000	1	127 (3226)	72 (1829)	50 (1270)	2	3100 (1407)
2500/3000 ⑤	4600	400	400,000	1	127 (3226)	72 (1829)	50 (1270)	2	3100 (1407)
<b>4000–4800 V Reversing</b>									
1250/1500 ④	4600	400	400,000	3	127 (3226)	72 (1829)	50 (1270)	2	3650 (1657)
2500/3000 ⑤	4600	400	400,000	3	127 (3226)	72 (1829)	50 (1270)	2	3650 (1657)
<b>6600 V Non-Reversing</b>									
2000/2250 ④	6600	400	570,000	1	127 (3226)	72 (1829)	50 (1270)	2	3100 (1407)
4000/4500 ⑤	6600	400	570,000	1	127 (3226)	72 (1829)	50 (1270)	2	3100 (1407)
<b>6600 V Reversing</b>									
2000/2250 ④	6600	400	570,000	3	127 (3226)	72 (1829)	50 (1270)	3	3650 (1657)
4000/4500 ⑤	6600	400	570,000	3	127 (3226)	72 (1829)	50 (1270)	3	3650 (1657)

② Horsepower based on NEMA standard design B motor at 1800 rpm.

③ Includes horizontal bus and plenum.

④ At higher hp rating, maximum acceleration time is 3.5 seconds.

⑤ At higher hp rating, maximum acceleration time is 6 seconds.

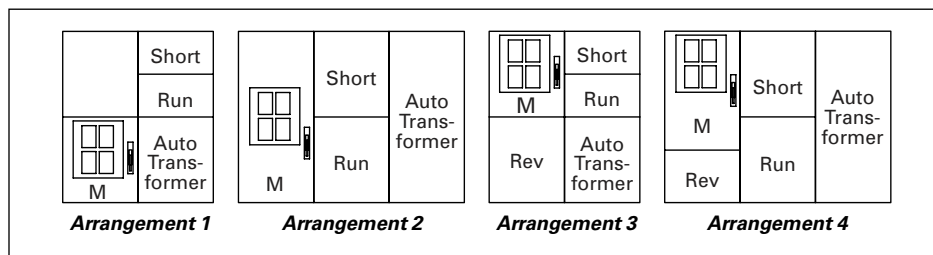

**Figure 10.2-7. Starter Arrangements**

## Reduced Voltage Solid-State

### Soft Starter Ampgard MV4S Starters



**Ampgard 400A Soft Starter**  
(Shown in Non-Arc-Resistant Enclosure)

#### Equipment Details

##### Mounted in the Medium-Voltage Sections

- Three incoming line connectors
- Drawout three-pole gang-operated line isolating switch assembly with isolating shutter, external operating handle interlocked to prevent opening the medium-voltage compartment door until the isolating switch is open and grounded
- Vertically mounted current limiting power fuses with pop-up blown fuse indicators
- One magnetic three-pole vacuum contactor with dc operating coils and mechanical interlock to prevent opening the isolating switch when contactor is closed
- One control power transformer (115 V secondary)
- Two CPT primary current limiting fuses
- Four electrical interlocks (2NO, 2NC)
- Three current transformers
- Withdrawable SCR truck with fully rated vacuum bypass contactor

##### Mounted in the Low-Voltage Compartment

- Control panel with:
  - One EMR-3000 motor protection relay
  - One interposing control relay
- Set of control circuit terminal blocks
  - One control circuit secondary fuse
  - One run-test circuit

##### Mounted in Lower Door Compartment

- Soft start control module with Modbus and RS-232 interface for remote communications
- User interface module with 2 x 20 character LCD display, 12 LEDs, and eight pushbuttons

**Table 10.2-12. Starter Selection Information—Dimensions in Inches (mm)**  
Dimensions for estimating purposes only.

Volts	Horsepower ①②	SCR/Contactor Ampere Rating	Starter Interrupting Rating (AIC)	Dimensions			Add. Starter Spaces	Weight Lb (kg)
				Height ③	Width ④	Depth		
2300	1500	400	50,000	127.00 (3226.0)	36.00 (914.4)	50.00 (1270.0)	0	2000 (908)
3300	1800	400	50,000	127.00 (3226.0)	36.00 (914.4)	50.00 (1270.0)	0	2000 (908)
4160	2500	400	50,000	127.00 (3226.0)	36.00 (914.4)	50.00 (1270.0)	0	2000 (908)

① Horsepower based on NEMA standard design B motor at 1800 rpm.

② Based on maximum acceleration time of 30 seconds.

③ Includes horizontal bus and plenum.

④ Does not include incoming line provisions.

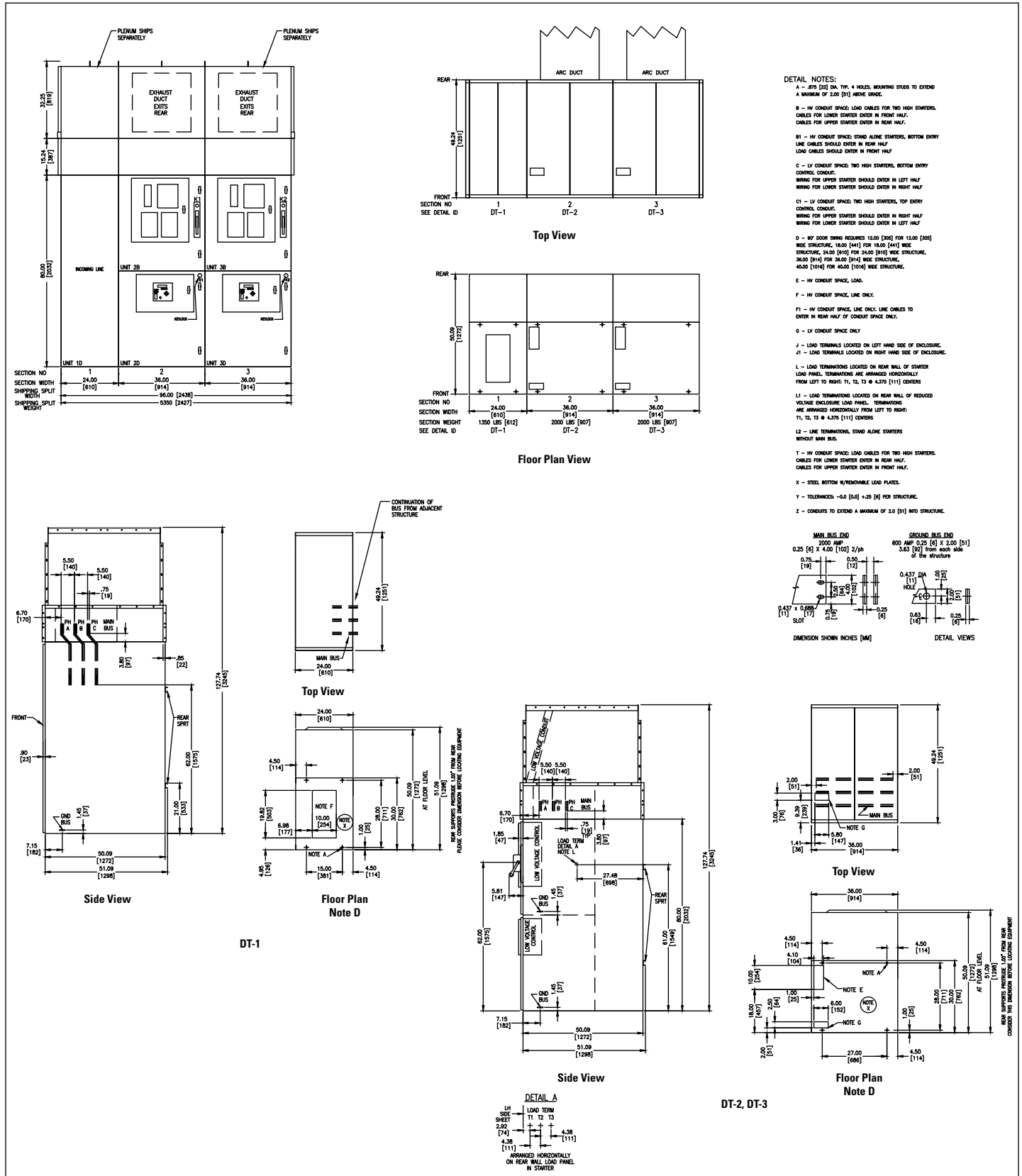

Figure 10.2-8. Arrangement Detail (400 A Solid-State Reduced Voltage)—Dimensions in Inches (mm)—See Table 10.2-13 on Page 10.2-24 for Notes

**Table 10.2-13. Arrangement Detail Notes**

Note	Description
<b>Cable Notes</b>	
	400 A starter load connection is designed for maximum of one 500 kcmil or two 350 kcmil.
	800 A starter load connection is designed for maximum of one 750 kcmil or two 500 kcmil.
<b>Arrangement Notes</b>	
A	0.875 dia. typical 4 holes. Mounting studs to extend a maximum of 2.00 inches (50.8 mm) above grade.
B	HV conduit space, load cables for two-high starters. Cables for lower starter enter in front half of conduit space, and cables for upper starter enter in rear half.
B1	HV conduit space, line and load cables for bottom entry stand-alone starters. Line cables should enter in rear half of conduit space, and load cables should enter in front half of conduit space.
C	LV conduit space for two-high starters with bottom entry control conduit. Control wiring for upper starter should enter in left half of conduit space, and lower starter control wiring should enter in right half of conduit space.
C1	LV conduit space for two-high starters with top entry control conduit. Control wiring for upper starter should enter in right half of conduit space, and lower starter control wiring should enter in left half of conduit space.
D	90 ° door swing requires 12.00 inches (304.8 mm) for 12.00-inch (304.8 mm) wide structure, 18.00 inches (457.2 mm) for 18.00-inch (457.2 mm) wide structure, 24.00 inches (609.6 mm) for 24.00-inch (609.6 mm) wide structure, 36.00 inches (914.4 mm) for 36.00-inch (914.4 mm) wide structure and 40.00 inches (1016.0 mm) for 40.00-inch (1016.0 mm) wide structure.
E	HV conduit space, load.
F	HV conduit space, line only.
F1	HV conduit space, line only. Line cables to enter in rear half of conduit space only.
G	LV conduit space only.
L	Load terminations located on rear wall of starter mounted on a load panel. Terminations are arranged horizontally from left to right. T1, T2, T3 left to right at 4.38-inch (111.3 mm) centers.
L1	Load terminations located on rear wall of reduced voltage enclosure mounted on a load panel. Terminations are arranged horizontally from left to right. T1, T2, T3 left to right at 4.38-inch (111.3 mm) centers.
T	HV conduit space, load cables for two-high starters. Cables for lower starter enter in rear half of conduit space, and cables for upper starter enter in front half.
X	Steel bottom with removable lead plates.
Y	Tolerances -0.0 inches +0.25 inches per structure.
Z	Conduits to extend a maximum of 2.00 inches (50.8 mm) into structure.



Arc-Resistant Starter Layout

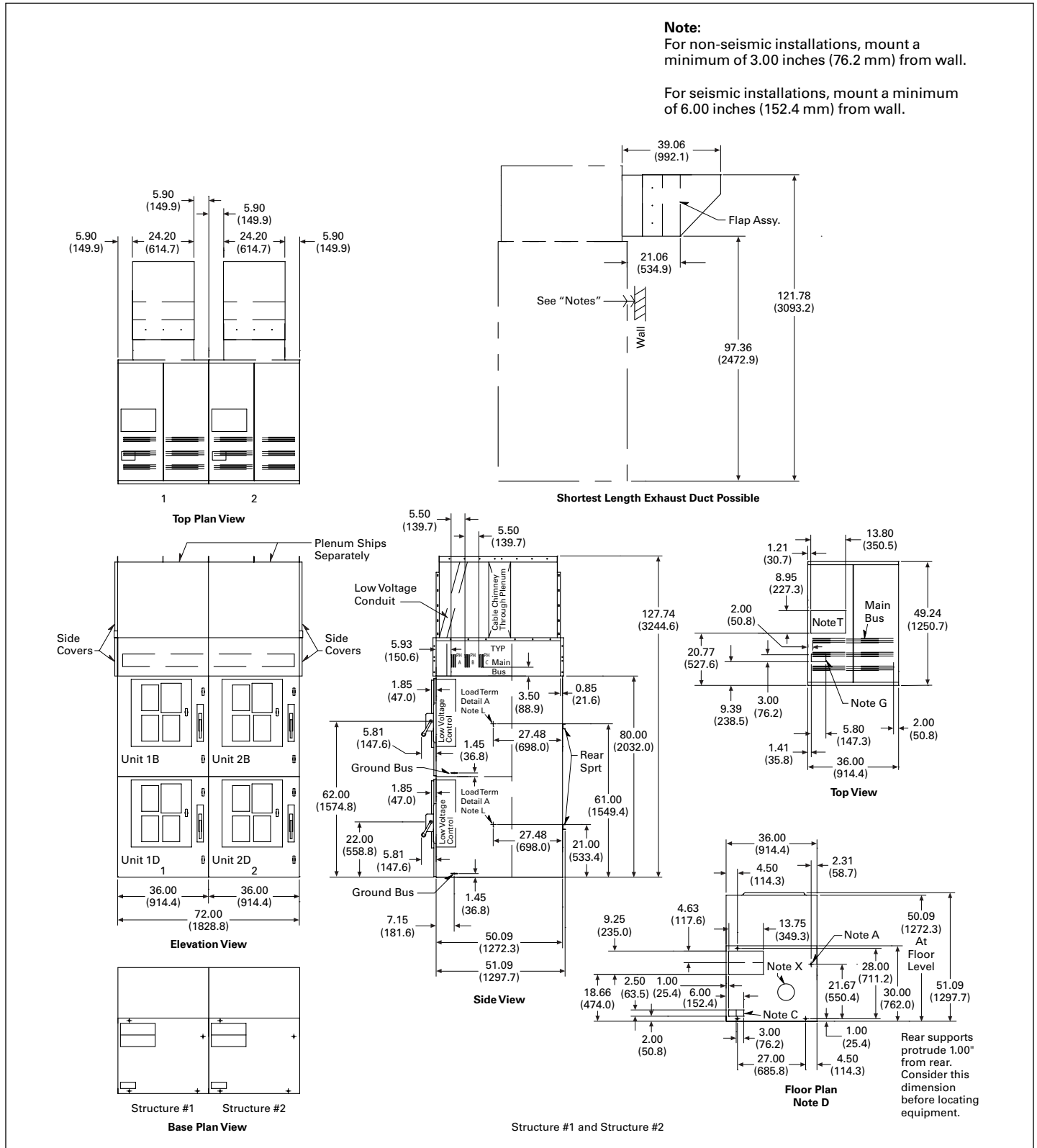

Figure 10.2-9. 50 kA Arc-Resistant, 24.00-Inch (609.6 mm) Incoming Cable Section and Two-High 400 A Starter Section—Dimensions in Inches (mm)

Typical Wiring Diagrams

Full Voltage FVNR Starter

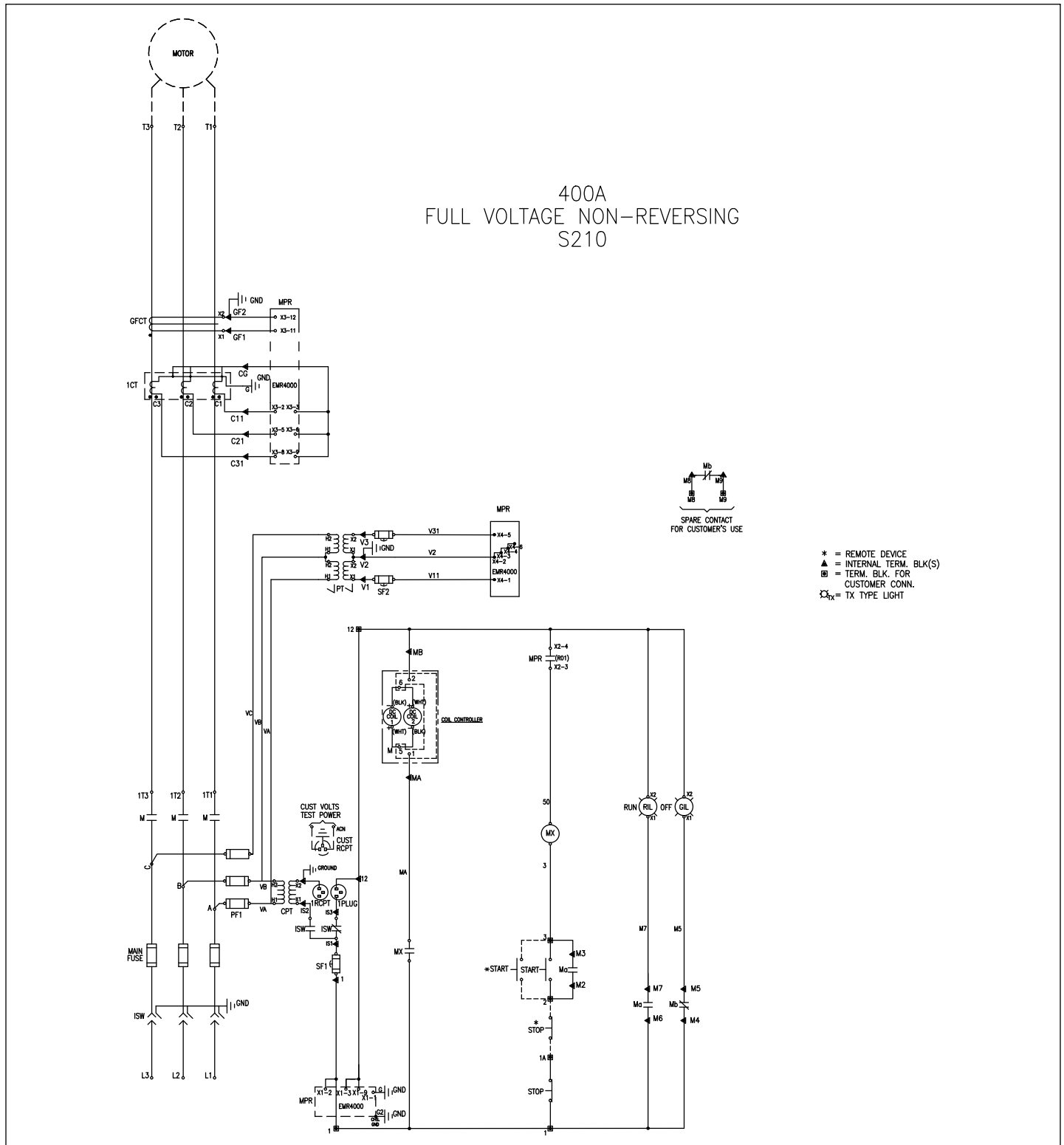

Figure 10.2-10. Induction Motor Across-the-Line Starter, Vacuum Contactor with Optional EMR-4000 Motor Protection, Start-Stop Pushbuttons, and Red and Green Indicating Lights

Reduced Voltage Autotransformer RVAT Starter

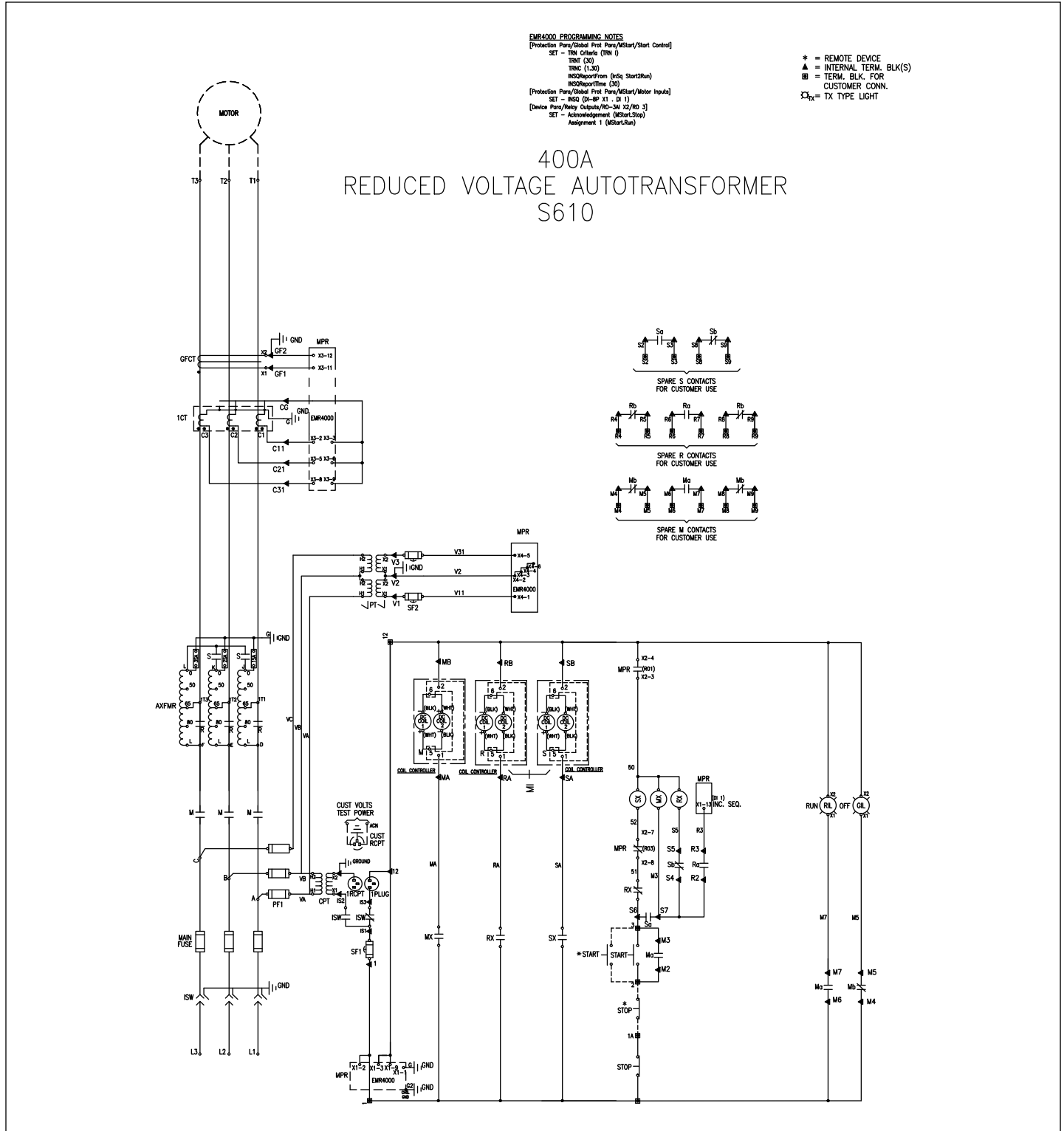

Figure 10.2-11. Induction Motor Reduced Voltage Autotransformer Starter, Vacuum Contactor with Optional EMR-4000 Motor Protection, Start-Stop Pushbuttons, and Red and Green Indicating Lights

Solid-State Reduced Voltage Starter

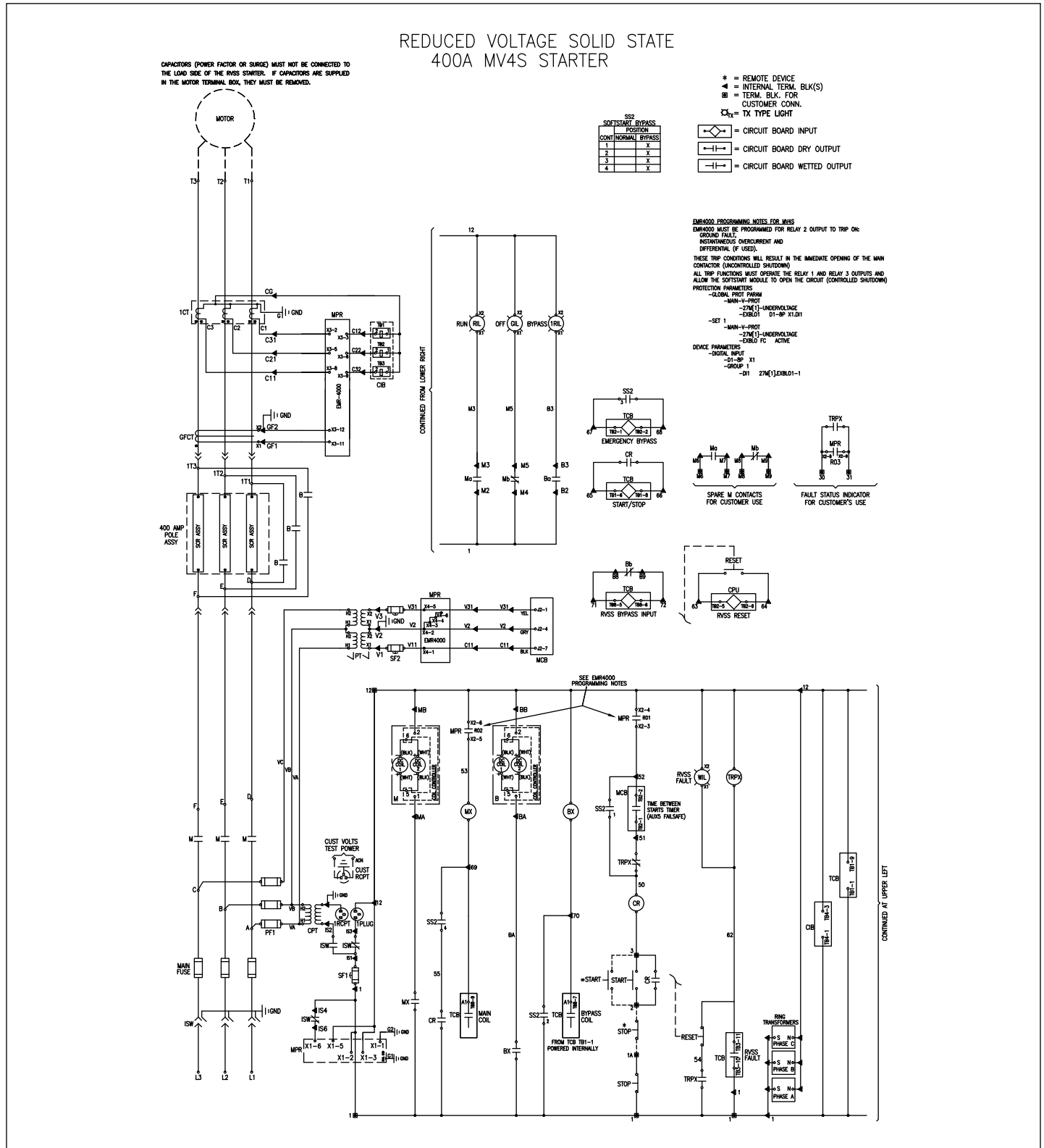

Figure 10.2-12. Induction Motor Reduced Voltage Solid-State Starter, Vacuum Contactor with EMR-4000 Motor Protection, Local and Remote Start-Stop Pushbuttons, and Local and Remote Red and Green Indicating Lights

## Fuses and Current Transformers

### Starter Fuse Information

Table 10.2-14. R-Rated Fuses—Motor Application

Voltage	Starter Size	FLA-Min.	FLA-Max.	Fuse	
5 kV	400 A	10.9	18.6	1R	
		18.7	31.1	70-2R	
31.2		46.7	100-3R		
46.8		62.3	130-4R		
62.4		74.7	150-5R		
74.8		93.5	170-6R		
93.6		137	200-9R		
137.1		187	230-12R		
187.1		244	390-18R		
244.1		400	450-24R ①		
800 A		400.1	750	800-44R ②	
7.2 kV		400 A	10.9	34.2	70-2R
			34.3	46.7	100-3R
	46.8		56.7	130-4R	
	56.8		68.4	150-5R	
	68.5		85.1	170-6R	
	85.2		137	200-9R	
	137.1		187	230-12R	
	187.1		273	390-18R	
	273.1		400	450-24R ①	
	800 A		400.1	720	800-44R

① For FLA >360, verify motor LRA and accel times are within allowable fuse characteristics.

② For FLA >720, verify motor LRA and accel times are within allowable fuse characteristics.

**Note:** For motor applications, fuses are sized based on locked rotor amperes of 6-times full load amperes and acceleration time of 10 seconds.

Table 10.2-15. Current Transformer Application

Voltage	Starter Size	FLA-Min.	FLA-Max.	CT(R:5)	
5 kV/7.2 kV	400 A	10	22.9	25	
		23	41.9	50	
		42	62.9	75	
		63	82.9	100	
		83	123.9	150	
		124	165.9	200	
		166	246.9	300	
		247	328.9	400	
		329	400	600	
		800 A	401	492.9	600
		493	656.9	800	
		657	750	1000	

**Note:** CT class is C5 or higher. All have sufficient burden capability to drive most electronic overload relays.

Table 10.2-16. E-Rated Fuses—Feeder/Transformer Application

Voltage	Starter Size	FLA-Min.	FLA-Max.	Fuse	
5 kV	400 A	1	7.1	10E	
		7.2	10.7	15E	
		10.8	14.3	20E	
		14.4	17.9	25E	
		18	21.4	30E	
		21.5	28.6	40E	
		28.7	35.7	50E	
		35.8	46.4	65E	
		46.5	57.1	80E	
		57.2	71.4	100E	
		71.5	89.3	125E	
		89.4	107.1	150E	
		107.2	125	175E	
		125.1	142.9	200E	
		143	178.6	250E	
		178.7	214.3	300E	
		214.4	250	350E	
		250.1	285.7	400E	
		285.8	321.4	450E	
		800 A	321.5	428.6	600E
		428.7	535.7	750E	
		7.2 kV	400 A	1	7.1
	7.2			10.7	15E
10.8	14.3			20E	
14.4	17.9			25E	
18	21.4			30E	
21.5	28.6			40E	
28.7	35.7			50E	
35.8	46.4			65E	
46.5	57.1			80E	
57.2	71.4			100E	
71.5	89.3			125E	
89.4	107.1			150E	
107.2	125			175E	
125.1	142.9			200E	
143	178.6			250E	
178.7	214.3			300E	
214.4	250			350E	

**Note:** For feeder (transformer) applications, fuses are sized for transformer full load amperes times 1.4.

**Note:** 350E is largest rating available in 7.2 kV rating.

## Voltage Transformers

**Table 10.2-17. Standard Voltage Transformer, 60 Hz Accuracy**

kV Class	Standard Ratios	Burdens at 120V	Thermal Rating VA at 55 °C	Metering VA at 55 °C
7.2	20, 30, 35, 40, 55, 60	0.6WXY 1.2Z	100	25

**Table 10.2-18. Standard Voltage Transformer Ratio Information**

Rating—Volts	2400	3600	4200	4800	6600	7200	12,000	12,500	13,200	13,800	14,400
Ratio	20:1	30:1	35:1	40:1	55:1	60:1	100:1	105:1	110:1	115:1	120:1

## Heat Loss Data

**Table 10.2-19. Heat Loss in Watts, at 60 Hz**

Contacting Rating	Operating Amperes	Heat Loss
400 A	187 A	400 W
400 A	400 A	800 W
800 A	720 A	1150 W

**Eaton**  
1000 Eaton Boulevard  
Cleveland, OH 44122  
United States  
Eaton.com

© 2019 Eaton  
All Rights Reserved  
Printed in USA  
Publication No. CA020003EN / Z23219  
September 2019