

Medium-voltage power distribution and control systems > Motor control >

# 15 kV motor control (Ampgard)— medium voltage

## Contents

<b>General Description</b> .....	<b>10.3-2</b>
General Description .....	10.3-2
Starter Types .....	10.3-7
Standard Ratings .....	10.3-9
<b>Devices</b> .....	<b>10.3-10</b>
Isolation Switch .....	10.3-10
Contactors .....	10.3-11
Current Limiting Fuses .....	10.3-12
Incoming Line .....	10.3-12
Accessories .....	10.3-12
<b>Layouts and Dimensions</b> .....	<b>10.3-13</b>
Full Voltage .....	10.3-13
Reactor .....	10.3-15
Autotransformer .....	10.3-17
Synchronous .....	10.3-20
<b>Application Details</b> .....	<b>10.3-21</b>
Typical Wiring Diagrams .....	10.3-21
Fuses and Current Transformers .....	10.3-23
Voltage Transformers .....	10.3-23
Heat Loss Data .....	10.3-23



# EATON

Powering Business Worldwide



More about this product  
[Eaton.com/Ampgard](https://Eaton.com/Ampgard)



Complete library of design guides  
[Eaton.com/designguides](https://Eaton.com/designguides)



Ampgard Motor Control Assembly

## General Description

Eaton's Ampgard® medium-voltage metal-enclosed control family provides control and protection of medium-voltage motors and equipment rated 2300–13,800 V nominal/15,000 V maximum.

## Application Description

Ampgard control has a complete metal-enclosed offering of full and reduced voltage starting of medium-voltage motors up to 7500 hp induction and 8500 hp synchronous.

## Enclosures

Ampgard products are available in NEMA® 1 general purpose enclosures as standard. NEMA 12 (dust tight), NEMA 3R (outdoor) and arc-resistant enclosures are available options for most products. Contact Eaton for exceptions. Enclosure type affects the maximum continuous current rating of the starters in the enclosure. Refer to **Table 10.3-3 on Page 10.3-9** for specific ratings.

## Features, Benefits and Functions

**Personnel safety:** Positive mechanical isolating switch with visible disconnect completely grounds and isolates the starter from the line connectors with a mechanically driven isolating shutter, leaving no exposed high voltage. Medium-voltage door is mechanically locked closed with interlocking mechanism; low-voltage section has separate door and is segregated from the medium-voltage section.

**Ease of installation:** Current limiting fuses, contactor assembly and isolating switch assembly are easily removed from the enclosure; line and load terminals are completely accessible from the front.

**Ease of maintenance:** All components are front accessible, facilitating routine inspection and/or parts replacement. The low-voltage compartment is painted white as standard to maximize serviceability.

**Simplicity of design:** Component-to-component design eliminates half of the electrical connections.

**Time-proven contactor technology:** Vacuum contactor ratings are 300 A at 15 kV. 300 A 15 kV contactor is available as stab-in design only.

**High degree of isolation:** Main bus is located in separate compartment on top of lineup. Vertical bus is barriered in rear of starter. A vertical low-voltage wireway is provided for isolation of customer control wiring. The low-voltage control compartment is isolated from medium voltage by grounded steel barriers.

Starter catalog types are available for the following applications:

- Squirrel cage, full voltage (reversing and non-reversing)
- Squirrel cage, primary reactor
- Squirrel cage, autotransformer
- Synchronous full voltage
- Synchronous primary reactor
- Synchronous auto-transformer (reversing and non-reversing)

## Personnel Safety Features

One of the most important considerations in designing the Ampgard starter was personnel safety. The result is an extensive system of interlocks and other safety features.

### Interlocks

Interlocking on Ampgard starters includes:

- Isolating switch mechanism locks the medium-voltage door closed when the switch is in the ON position
- Provision for optional key interlocks
- When door is open, interlock prevents operating handle from being moved inadvertently to ON position
- When contactor is energized, isolating switch cannot be opened or closed

### Other Safety Features

Ampgard starters include many additional features designed to protect operating personnel. These features include:

- Provision for a padlock on the isolating switch handle in OFF position
- Shutter barrier between line terminals and isolation switch stabs is mechanically driven
- Distinctive marking on switch assembly appears when shutter barrier is in position and starter is completely isolated from the line
- Grounding clips provide a positive grounding of the starter and main fuses when the isolating switch is opened
- High- and low-voltage circuits are compartmentalized and isolated from each other
- The drawout isolation switch is easily removed by loosening two bolts in the back of the switch. The shutter remains in place when the switch is withdrawn

**Isolated Low-Voltage Control**

The low-voltage door has four cutouts as standard.

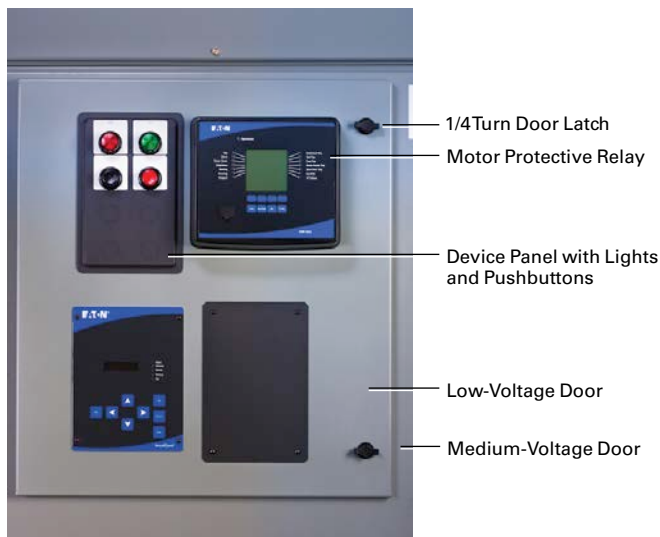

**Ampgard Starter Door Closed**

Distinctive Markings on Isolation Switch Shutter Indicate Shutter is Closed and Switch is Open

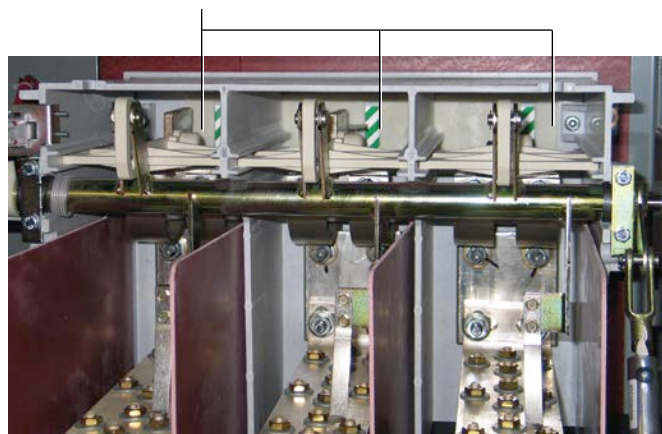

**View of Isolation Switch Through Viewing Window**

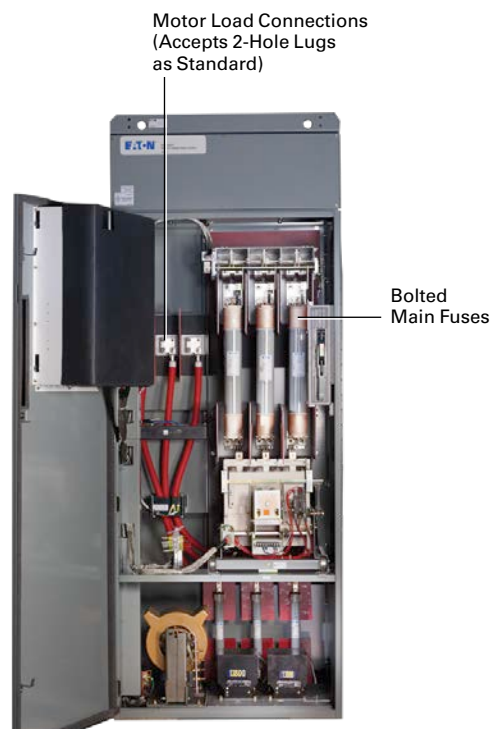

**Ampgard 300 A Starter—Medium-Voltage Door Open**

Device panels are provided on the low-voltage door to simplify the mounting of pilot devices. The low-voltage control panel is behind the low-voltage door and is completely isolated from the medium-voltage compartment. A standard viewing window allows visual verification of the isolation switch status before attempting to open the medium-voltage door. The medium-voltage door is locked closed whenever the isolation switch is closed.

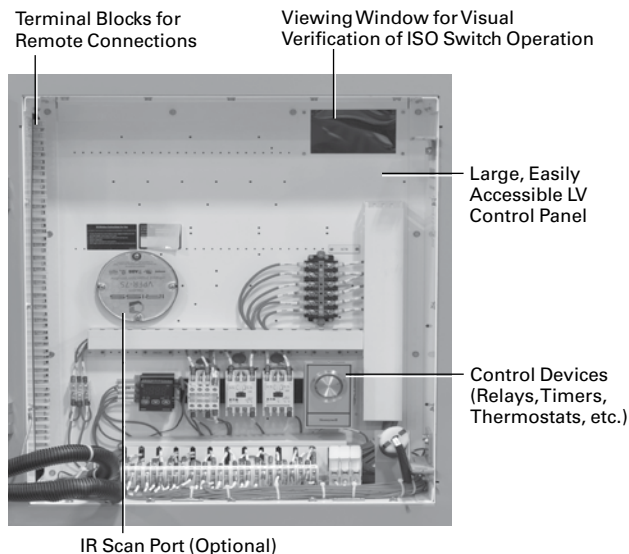

**Ampgard Starter—Low-Voltage Compartment**

Estimated low-voltage compartment dimensions  
22 inches W x 25 inches H x 8 inches D.

## Bus and Optional Features

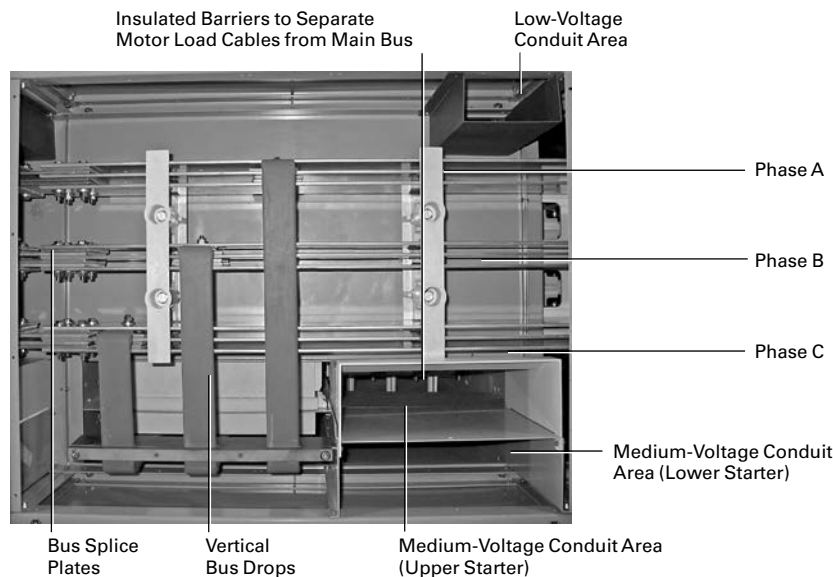

*Bus Compartment Top View 3000 A Main Horizontal Bus*

### Main Bus

When starters are grouped together in a lineup, a typical option is the main bus. The Ampgard main bus is mounted in its own 12-inch (305 mm) high top-mounted enclosure, which isolates it from the starter. The connection from the main bus to the starter is done with rigid vertical bus. Insulated barriers are provided for separate top entry of power and control cables. The main bus is top, side and front accessible, which allows for ease of maintenance or extension of lineup without disassembling the starters.

Main bus is available for 1000, 1200, 2000 and 3000 A. Fully insulated bus is standard on 15 kV starters. Bus may be supplied with either tin or silver plating. Crossover bus available in 1000, 1200, 2000 and 3000 A. Busway entry and pull boxes for 3000 A require an additional 24-inch section or main bus without vertical bus drops.

The standard bus short circuit rating is 50 kA for 10 cycles per NEMA and UL standards. An optional 50 kA, 2-second bus rating is available for customers that require a higher rating for the main bus.

### Vertical Bus

Vertical bus is located behind a fixed barrier in the rear of the enclosure. It is fully insulated as standard, with plating to match that of the main bus.

### Other Optional Features

Ampgard starters are available with a variety of accessories and modifications to satisfy a wide range of application requirements. Some of the broad areas covered include:

- Bus and cable entrance enclosures
- Transformers
- Power factor correction capacitors
- Operators and pilot devices
- Instruments and meters
- Control relays and timers
- Solid-state or selected electro-mechanical protection devices

## Standards and Certifications

### UL, CSA and IEC Certification

Ampgard starters are designed, assembled and tested to meet all applicable standards:

- NEMA/ANSI ICS3
- UL 347
- CSA® C22.2 No. 14

The major components, i.e., contactor, isolating switch, fuses, EMR-3000 and EMR-4000 are UL recognized.

UL or CSA labeling of a specific starter requires review to ensure that all requested modifications and auxiliary devices meet the appropriate standards. Refer to factory when specified. Ampgard starters meet the requirements of IEC standards 60694, 60298 and 60470.

**Contactor-Fuse Coordination**

The AMGARD starter provides ensured coordination between its fuses, contactor, current transformers, protective relays, and the motor it is controlling.

One of the most critical coordination issues is between the contactor and the starter fuses. The fuses must interrupt faults greater than the interrupting rating of the contactor. By comparing the fuse curve with the contactor rating, it can be observed that for faults greater than 8500 A, the fuse will open before the contactor. With faults less than 8500 A, the contactor may clear the fault before the fuse blows, depending on the settings of the protective relays. Refer to **Figure 10.3-1** for an illustration of Ampgard coordination.

Other vacuum contactors available today may have lower interrupting ratings than the Ampgard Type SL vacuum contactors. Dropout times also vary, and may be as short as two cycles on other starter designs. Lower interrupting ratings and shorter dropout times can result in fault current levels where the contactor may be required to interrupt a fault greater than its rating. This can result in equipment failure. Refer to **Figure 10.3-2** for an illustration of an improperly coordinated starter.

Ampgard starters also ensure coordination between other starter components. The current transformers and protective relays are selected to work properly with each other, and to protect the motor. Protective relays like Eaton’s EMR-3000 provide optimal motor protection, while also rapidly opening the contactor during fault conditions. This rapid opening signal cannot open the contactor in less than its set dropout time, but it will take the motor off-line in the shortest possible time.

This will help minimize mechanical damage to the motor and may prevent the starter fuses from blowing by allowing the contactor to clear the fault (only if the fault is less than the contactor interrupting rating).

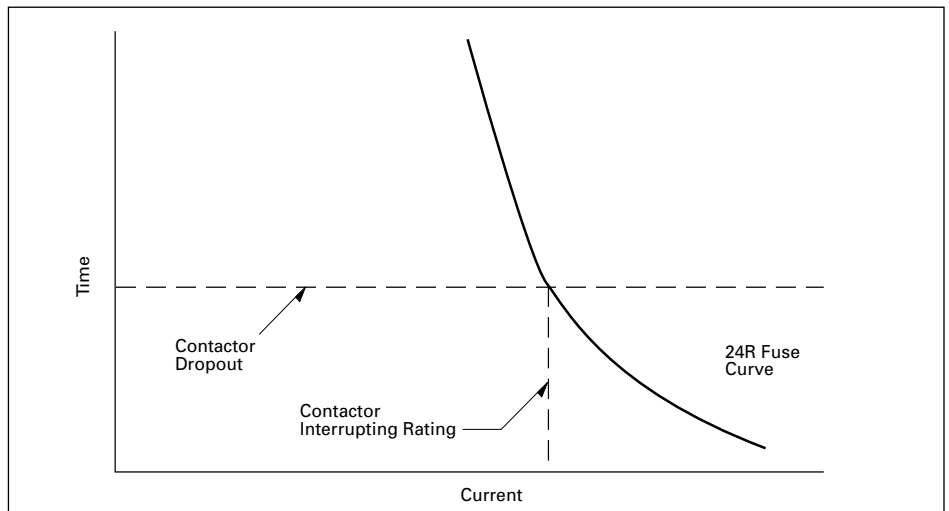

**Figure 10.3-1. Proper Contactor Fuse Coordination Found in Ampgard Starter**

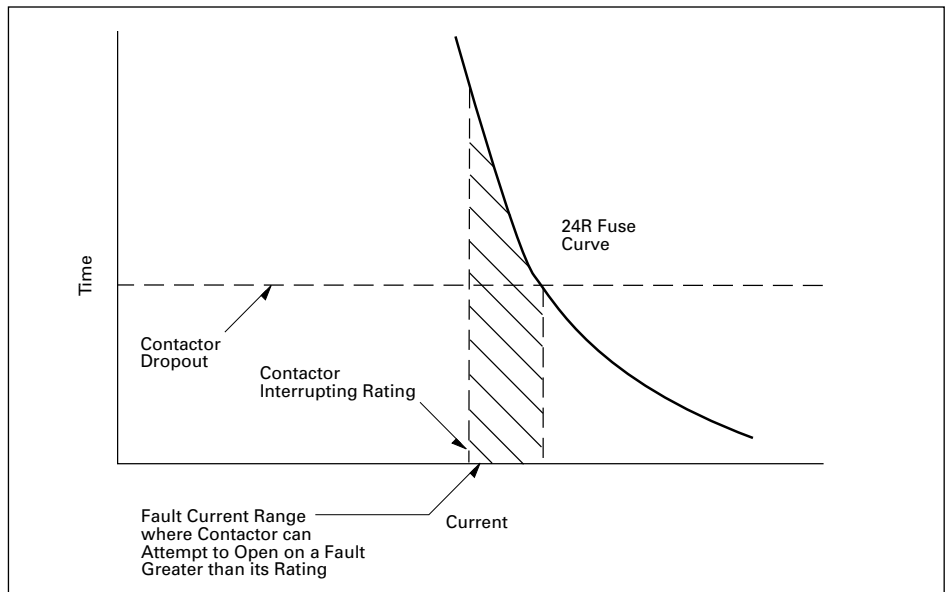

**Figure 10.3-2. Contactor Fuses That Are Not Properly Coordinated**



**Protection Considerations**

Coordinated with the motor’s characteristics, the protective devices in the Ampgard starter provide motor protection from overload to full system capacity faults.

Ampgard starters are supplied with an adjustable thermal overload relay as standard.

Multifunction solid-state motor protection relays are a common option on Ampgard starters. The EMR-3000 is typically provided when a multi-function relay is specified. The EMR-3000 provides many types of protection including overload, locked rotor, ground fault and phase loss/phase unbalance. The EMR-3000 also provides start control logic to protect the motor against excessive starting. The relay may be applied to either across-the-line or reduced voltage starters. On reduced voltage starters, the EMR-3000 can control the transition from reduced to full voltage, offering the greatest protection for the motor and starter. An optional RTD module can be supplied for motors with built-in RTDs. The EMR-4000 can be supplied when voltage monitoring and protection are required.



**EMR-3000 Motor Protective Relay**

InsulGard™ relays are an available option on Ampgard starters. The InsulGard provides early warning of increasing partial discharge levels in the starting equipment, cables and motor.

This early warning will help the user to better schedule maintenance and avoid unplanned downtime.

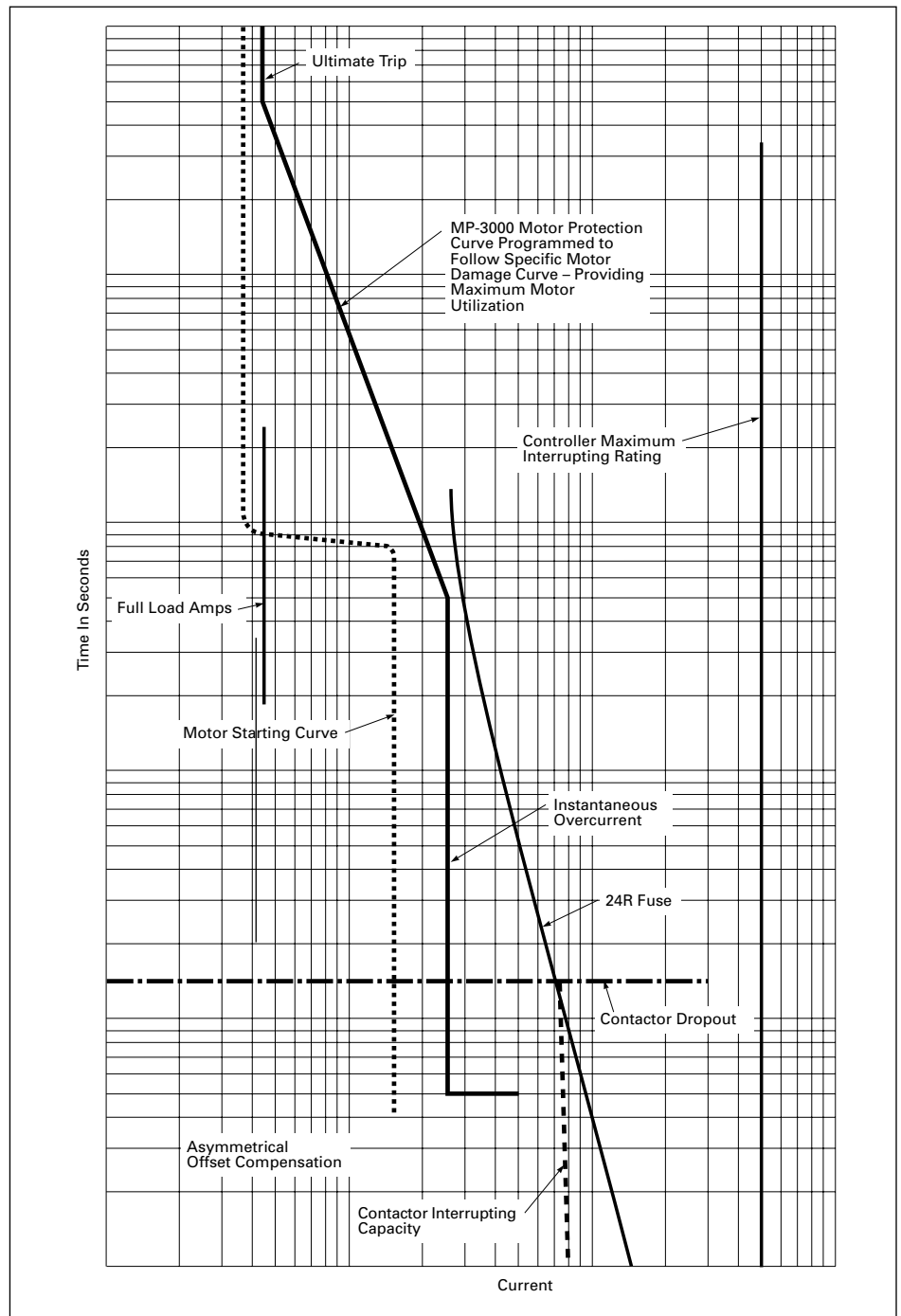

**Figure 10.3-3. Full Range Coordinated Protection Between Current Limiting Type CLS Fuses, Vacuum Contactor and Motor Protection Relay**

## Starter Types

### Reduced Voltage Starters

Eaton offers traditional electro-mechanical reduced voltage starters in addition to reduced voltage solid-state (RVSS) starters. Unless otherwise specified, reactors and autotransformers are NEMA medium duty rated. They are designed for three 30-second starts per hour. Heavy-duty reactors and transformers can be supplied when specified. Locked rotor current must be specified when ordering reduced voltage starters to ensure that the reactors or autotransformers are properly sized.

### Reduced Voltage Reactor Starter

**Table 10.3-1. Type 502 Reactor Starting Characteristics**

Starter Type	% Motor Voltage	% Motor Current	% Line Current	% Torque
80% tap	80	80	80	64
65% tap ①	65	65	65	42
50% tap	50	50	50	25

① Factory set on 65% tap.

#### Advantages

- Reduces starting currents
- Least costly reduced voltage starting method

#### Disadvantages

- Large footprint: 4 structures at 400 A
- “Bump” on transition to full voltage
- Not as efficient as autotransformer
- Due to reduced torque during starting, motor must typically be unloaded during the start sequence

#### Sequence of Operation

- Main contactor (M) closes
- Current flows through reactor reducing voltage to motor (based on tap setting)
- When motor current reaches ~125%, the run contactor (R) closes providing full voltage to the motor

### Reduced Voltage Autotransformer Starter

**Table 10.3-2. Type 602 Auto Transformer Starting Characteristics**

Starter Type	% Motor Voltage	% Motor Current	% Line Current	% Torque
80% tap	80	80	67	64
65% tap ①	65	65	45	42
50% tap	50	50	28	25

① Factory set on 65% tap.

#### Advantages

- Produces the most torque per incoming line ampere of any reduced voltage starting method
- Less costly than RVSS

#### Disadvantages

- Large footprint: 4 structures at 400 A
- More costly than reactor
- “Bump” on transition to full voltage
- Due to reduced torque during starting, motor must typically be unloaded during the start sequence

**Note:** Care should be taken when selecting the motor for reduced voltage starting to ensure that there is sufficient torque to accelerate the load at reduced voltage. Motors that do not fully accelerate at reduced voltage will generate high voltages at transition that can damage the autotransformer and void the factory warranty.

#### Sequence of Operation

- Shorting contactor (S) closes
- Main contactor (M) closes
- Current flows through autotransformer reducing voltage to motor (based on tap setting)
- When motor current reaches ~125%, the shorting contactor (S) opens and the run contactor (R) closes providing full voltage to the motor

**Note:** Because the motor is never disconnected from the supply voltage, the starting is closed transition.

### Full Voltage Starters

Eaton offers full voltage starters in single-high and two-high configurations to satisfy your most rigorous motor starting applications. The full voltage starter provides the most compact and cost-effective means for starting and stopping your motors and is available in single-speed and two-speed applications.

#### Ratings

- 2400–13,800 V
- Up to 8000 hp or 750 FLA
- NEMA 1, 12, 3R and arc-resistant enclosure ratings

#### Optional Features

- Main breaker
- Two-speed one winding and two-speed two winding
- Latched contactor option for transformer feeders

#### Industry Standards

- NEMA ICS3
- UL 347
- CSA
- EEMAC E14-1
- Manufactured in ISO 9001 and ISO 14001 certified facility

## Synchronous Starters

### Synchronous Motor Control, Brush-type or Brushless

Ampgard synchronous starters are available for Brush-type and Brushless Motors. The Brush-type design features the Ampgard exclusive “Soft-sync” that minimizes mechanical shock as the motor is synchronized.

Eaton Factory Authorized Start-up Service is recommended with all Synchronous Starters.

#### Brush-type

The Brush-type starter includes a three-phase exciter to generate dc rotor current up to 200 A plus a control board that determines the proper time to apply the dc field. Output voltage is available at 125 Vdc or 250 Vdc. Basic protections include:

- Locked rotor protection
- Incomplete sequence
- Failure to synchronize
- Blown fuse protection
- Pullout protection
- Field loss protection
- Power factor regulation/var regulation (option)

The protective features are displayed on an Eaton GP02 interface module. Stator protection is provided by an EMR-3000 or other solid-state motor protection relay.



*Ampgard Synchronous Starter*



*Brush-type Display with Trip Indication*

#### Brushless

The Basic Brushless starter includes a three-phase dc power supply to generate exciter field current up to 10 A plus a control board that provides basic protection. A solid-state motor protective relay is supplied for pullout protection. Output voltage is adjustable from 62–125 Vdc.

Stator protection is provided by an EMR-3000 or other solid-state motor protection relay.



## Standard Ratings

**Table 10.3-3. Starter Maximum Continuous Current Ratings**

Starter Class	Enclosure Type	
	NEMA 1	NEMA 12/NEMA 3R
One-high with 300 A 15 kV contactor	300	300

① Limited acceleration time and locked rotor current. Contact Eaton for details.

### Type SL, 300 A, 15 kV Vacuum Contactor/Starter Ratings

**Table 10.3-4. Type SL 15 kV Vacuum Contactor Ratings**

Description	SL12V330	SL15V330
Utilization voltage	10,000–11,000 V	12,400–13,800 V
Interrupting rating E1 (unfused) E2 (fused) E2 (fused)	5 kA 950 MVA at 11,000 V 50 kA	5 kA 1190 MVA at 13,800 V 50 kA
Induction motor	6000 hp (300 FLA)	7500 hp (300 FLA)
Synchronous motor (0.8 PF)	6000 hp	7500 hp
Synchronous motor (1.0 PF)	6750 hp	8500 hp
Transformer	3800 kVA at 11 kV	6800 kVA at 13.8 kV
BIL	75 kV	95 kV (with arrestors)

**Table 10.3-5. Type SL 15 kV Vacuum Contactor Specifications**

Specification	Rating
Maximum voltage	15,000 V
Maximum interrupting current (three operations)	5000 A
Rated current	300 A enclosed 300 A open
IEC make-break capability	AC3–make 3000 AC3–break 2400
Short-time current 30 seconds 1 second 8.75 milliseconds	1800 A 4500 A 43 kA peak
Mechanical life	250,000 operations
Electrical life	200,000 operations
Dielectric strength (60 Hz)	36 kV (1 minute)
BIL	75 kV (1.2 x 50 microseconds)
Closing time	80 milliseconds
Opening time	50 to 330 milliseconds (selectable)
Weight	95 lbs (43 kg)
Arcing time	12 milliseconds (3/4 cycle) or less
Pickup voltage	80% rated coil voltage
Dropout voltage	60% rated coil voltage
Control voltages (ac) (dc)	110/120/220/240 V (50/60 Hz) 125 V
Control circuit burden (rated voltage) Closing Holding	2600 VA 80 VA
Auxiliary contact ratings Voltage (maximum) Continuous current Making capacity (ac) Making capacity (dc) Breaking capacity (ac) Breaking capacity (dc)	600 V 10 A 7200 VA 200 VA 720 VA 200 VA
Latch (when specified) Mechanical life Trip voltages (dc) Trip voltages (ac) Tripping voltage Tripping burden 24 Vdc 48 Vdc and 96 Vdc 110 Vac and 220 Vac	250,000 operations 24/48/96 V 110/220 V (50/60 Hz) 80% rated coil voltage 1200 VA 400 VA 500 VA
Weight	95 lb (43 kg)

## Isolation Switch

### Mechanical Non-Loadbreak Isolating Switch

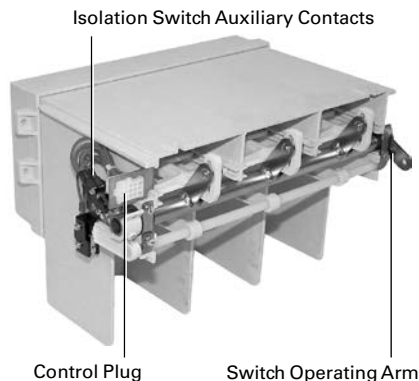

**JMT-400/800 A Isolation Switch  
Front View**

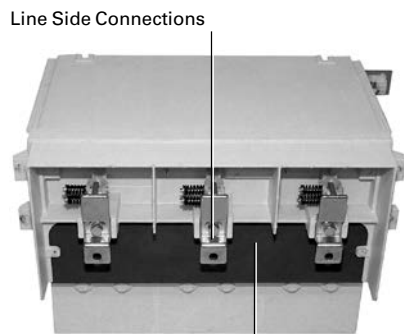

**JMT-400/800 A Isolation Switch  
Rear View**

#### General Description

Eaton's Type JMT-15 is a drawout, lightweight, three-pole, manually operated isolating switch mounted in the top of the starter enclosure. They may be easily removed by loosening two bolts in the rear of the switch. The JMT-15 is rated 300 A continuous at 15 kV. All isolation switches have a mechanical life rating of 10,000 operations.

The component-to-component circuitry concept includes the mountings for the current limiting fuses as part of the isolating switch.

#### Features

A positive mechanical interlock between the isolating switch handle mechanism and contactor prevents the isolating switch from being opened when the contactor is closed or from being closed if the contactor is closed.

An operating lever in the isolating switch handle mechanism is designed to shear off if the operator uses too much force in trying to open the non-loadbreak isolating switch when the contactor is closed. This feature ensures that the operator cannot open the switch with the main contactor closed, even if excessive force is used on the operating handle.

To operate the isolating switch, the operating handle is moved through a 180° vertical swing from the ON to the OFF position. In the ON position, a plunger on the back of the handle housing extends through a bracket on the rear of the starter high-voltage door, preventing the door from being opened with the switch closed. When the high-voltage door is open, a door interlock prevents the handle from being inadvertently returned to the ON position.

When the operating handle is moved from ON to OFF, copper stabs are withdrawn from incoming line fingers. As the stabs withdraw, they are visible above the top of the fuses when viewed from the front, and simultaneously grounded. As the fingers are withdrawn, a spring-driven isolating shutter moves across the back barrier to prevent front access to the line connections. As the shutter slides into position, distinctive markings appear on the back barrier, making it easier to check the position of the shutter.



**Switch Handle  
Closed**



**Switch Handle  
Open**

**Contactors**

**300 A, 15 kV Vacuum Contactor, Type SL**



**300 A Stab-in Contactor**  
15 kV Maximum

**300 A, 15 kV Stab-in Contactor**

The 300 A 15 kV SL Contactor is available in a one-high configuration and is rated at 300 A enclosed. The 300 A contactor is available with a stab-in type connection only. The 15 kV contactor is mounted on wheels and has similar features to the 800 A 7.2 kV contactor. The maximum starter current is 300 full load amperes when supplied with 15 kV 400 ampere CLS fuses.

**Design**

Eaton Vacuum Contactors are highly versatile, low-chop contactors that have been designed to meet all applicable NEMA standards and are UL® recognized components. The contactors accommodate mechanical interlocks that function with the starter isolation switch and with other contactors. These interlocks provide unmatched safety and service protection.

The contactors consist of a molded frame with moving armature, magnet and vacuum interrupters. The contactor is easily positioned into the starter, and vacuum interrupters provide long life with a minimal maintenance program. The SL operating coils are energized by a control board that provides a pulse-width-modulated dc output. Control voltages and contactor dropout times are programmed using a DIP switch located on the control board.

The control board is mounted in a protected cavity in the molded contactor frame to prevent inadvertent access to the voltage and dropout DIP switch. Four auxiliary contacts (2NO, 2NC) are supplied with each contactor and are wired to terminal blocks on the starter control panel.

The vacuum interrupters employ special main contact materials that exhibit a low chop current plus other specially engineered characteristics that minimize switching surges. Surge protection is therefore not required due to the use of the vacuum contactor. Surge protection may be required for other reasons such as the high probability of lightning strike, etc.

**Supplemental Devices**

A lift device is available to assist in withdrawal, removal and installation of medium-voltage breaker or contactor.

**Maintenance**

Reduced maintenance is one of the outstanding features of Eaton’s Vacuum Contactor line. The special contact material in the vacuum interrupters provides long life even under severe operating conditions. The main coils operate with a very low temperature rise to maximize insulation life. Steel bearings on the main shaft provide long, trouble-free operation.

An included simple go/no-go gauge is used for checking contact wear. Wear can be checked without removing the contactor from the starter. The vacuum contactor at 90 lb is much lighter than previous generation airbreak or vacuum contactors, which allows for easier insertion and removal from the starter structure.

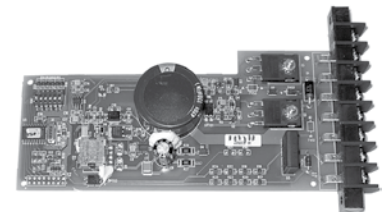

**Contactor Control Board**

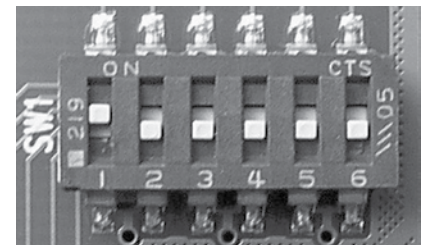

**DIP Switch on Contactor Control Board**

### Current Limiting Fuses

Ampgard starters use Eaton's Type CLS power fuses with special time/current characteristics for motor service. Type CLE or Type HLE power fuses are applied when the starter is used to feed a transformer. The fuse is coordinated with the contactor and overload relay characteristics to provide maximum motor/transformer utilization and protection. The standard mounting method for power fuses is bolted.

Interruption is accomplished without expulsion of gases, noise or moving parts. Type CLS/CLE/HLE fuses are mounted in a vertical position to ensure maximum rating reliability, proper operation and to eliminate the possibility of dust and dirt collecting, resulting in a deterioration of dielectric properties. When a fault has been cleared, a plastic indicator in the top of the fuse, normally depressed, pops up to give visible blown fuse indication.

Blown fuses may be removed and replaced without removing or drawing out the contactor. The control circuit primary fuses are also current limiting.



*Standard Fuse Mounting is Bolted with Optional Clip Mounting*



*Blown Fuse Indicating Device*

### Incoming Line

Depending on the size and number of incoming cables, an incoming line enclosure may be necessary. Different designs are available for incoming power for top or bottom entry.

When incoming line metering is specified, an additional 24-inch (610 mm) wide metering structure is typically supplied.

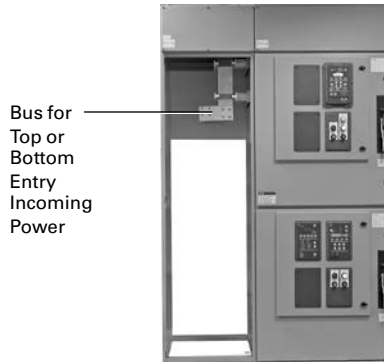

*Typical 24-Inch (610 mm) Wide Incoming Line Structure*

### Incoming Line Connection Options

- **Cable:** Maximum of six per phase, 750 kcmil maximum, top or bottom entry
- **Bus Duct:** Top only, 1200 A, 2000 A. Standard Eaton three-wire designs only
- **Transformer Throat:** Must be the standard design used by Eaton

### Microprocessor-Based Relays

Eaton's protective relays provide programmable circuit protection, information and operator conducted testing.

### Metering

Power Xpert® meters are available for multi-function metering.

### Communications

Eaton's Power Xpert Architecture communications provides for monitoring and controlling complete electrical distribution systems of those parts of a system selected by the operator.

### Accessories

#### Remote Operator

A remote operator for the starter isolation switch is an available option. The Ampgard Remote Operator (ARO) enables users to open or close the switch through the use of a pushbutton station operated up to 30 feet away from the starter. Users can mount the ARO on the front of the starter, plug it into any available 120 Vac source, then easily operate the isolation switch from outside the starter arc flash boundary.



*Ampgard Remote Operator*

## Full Voltage

### Full Voltage Squirrel Cage Starters Catalog S210 Non-Reversing

#### Equipment Details

##### *Mounted in the Medium-Voltage Section*

- Three incoming line connectors
- Drawout three-pole gang-operated line isolating switch assembly with isolating shutter, external operating handle interlocked to prevent opening the medium-voltage compartment door until the isolating switch is open and grounded
- Vertically mounted current limiting power fuses with pop-up blown fuse indicators
- One magnetic three-pole vacuum contactor with dc operating coils and mechanical interlock to prevent opening the isolating switch when contactor is closed
- One control power transformer (115 V secondary)
- Two CPT primary current limiting fuses
- Four electrical interlocks (2NO, 2NC)
- Three current transformers

##### *Mounted in the Low-Voltage Compartment*

- Control panel with:
  - One EMR-3000 motor protection relay
  - One interposing control relay
- Set of control circuit terminal blocks
  - One control circuit secondary fuse
  - One run-test circuit

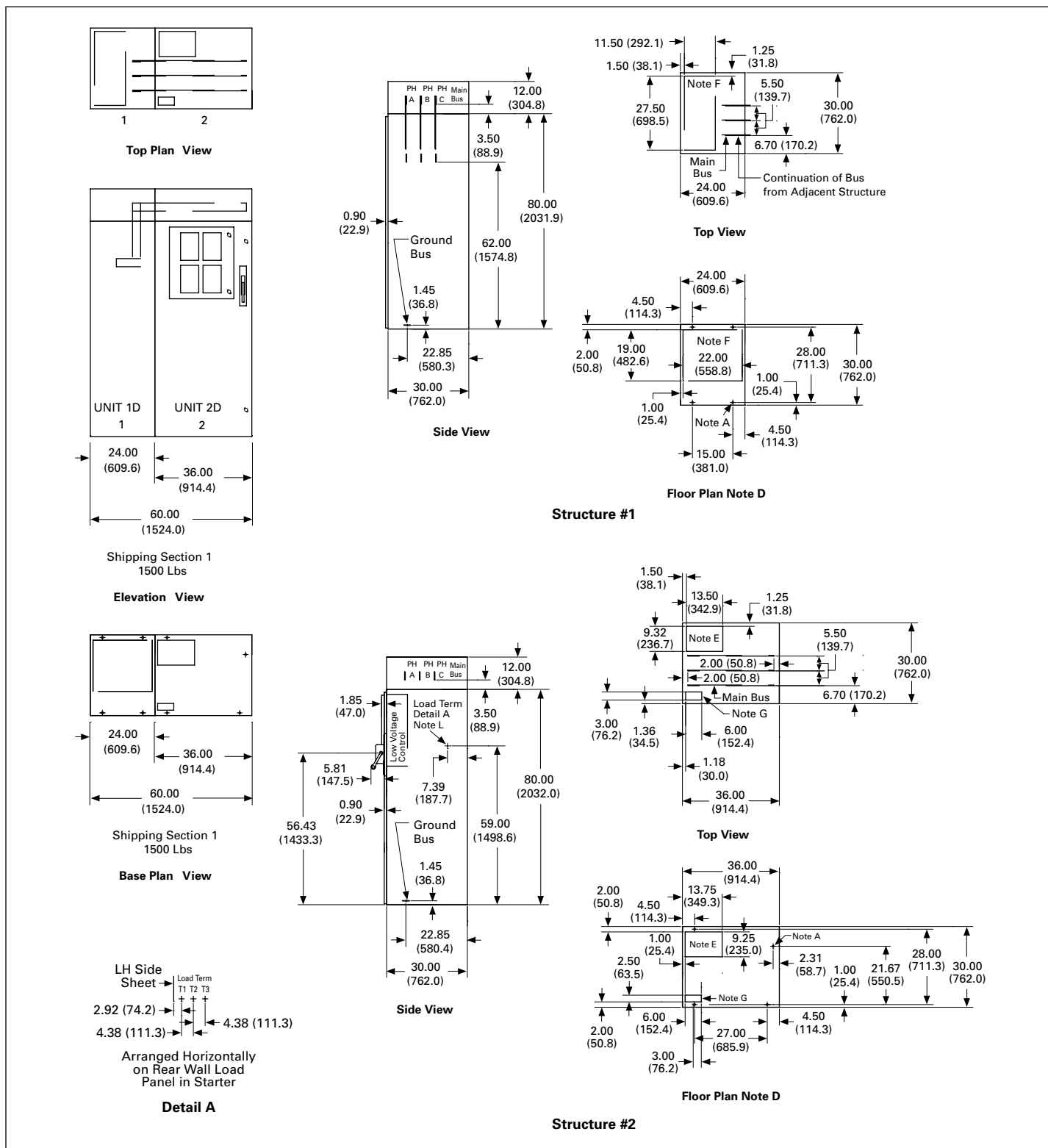

Figure 10.3-4. Arrangement 1 Detail (Full Voltage 15 kV)—Dimensions in Inches (mm)—See Table 10.3-8 on Page 10.3-19 for Notes



## Reactor

### Primary Reactor, Reduced Voltage Starters Catalog S510 Non-Reversing

#### Mounted in the Medium-Voltage Section

- Three incoming line connectors
- One drawout three-pole gang-operated line isolation switch assembly with isolating shutter, external operating handle interlocked to prevent opening the medium-voltage compartment door until the isolating switch is open and grounded
- One vertically mounted current limiting power fuse with pop-up blown fuse indicators
- One magnetic three-pole vacuum contactor with dc operating coils and mechanical interlock to prevent opening the isolation switch when the contactor is closed
- One control power transformer (115 V secondary)
- Two CPT primary current limiting fuses
- Four electrical interlocks (2NO, 2NC)

#### Mounted in the Low-Voltage Compartment

- One control panel with:
  - One EMR-3000 motor protection relay
  - Two interposing relays
- One set of control circuit terminal blocks
  - One control circuit secondary fuse
  - One run-test circuit

#### Reduced Voltage Structure

- One magnetic three-pole vacuum run contactor with dc operating coil and electrical interlocks
- Three current transformers
- One medium-duty starting reactor with 50–65–80% taps

#### Locked Rotor Amps

- Locked Rotor Amps (LRA) must be specified to ensure proper sizing of reactor

#### Starting Characteristics

**Table 10.3-6. Type 502 Reactor Starting Characteristics**

Starter Type	% Motor Voltage	% Motor Current	% Line Current	% Torque
80% tap	80	80	80	64
65% tap ①	65	65	65	42
50% tap	50	50	50	25

① Factory set on 65% tap.

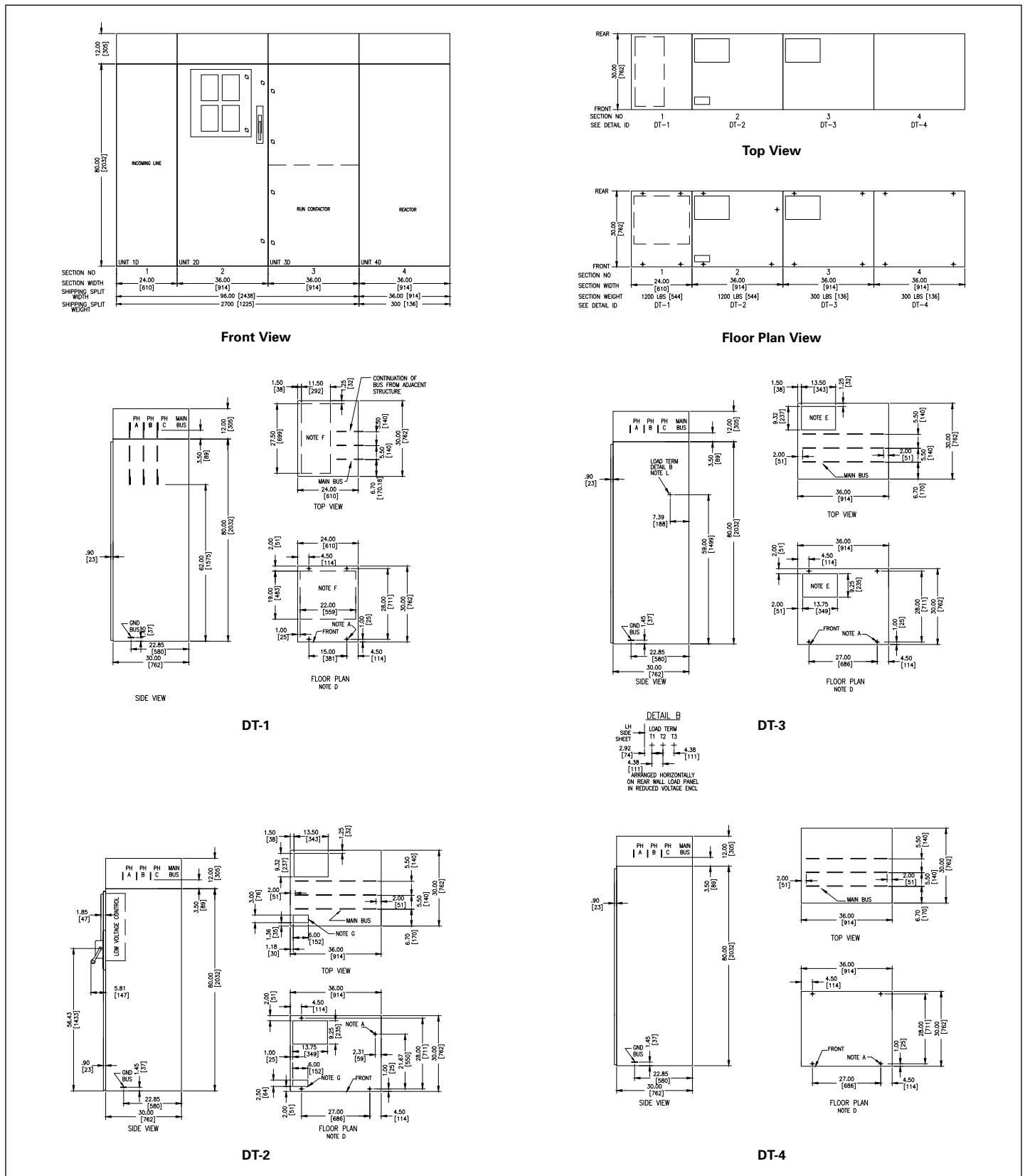

Figure 10.3-5. 15 kV Reactor—Dimensions in Inches (mm)

## Autotransformer

### Reduced Voltage Autotransformer Starters Catalog S610 Non-Reversing

#### Mounted in the Medium-Voltage Section

- Three incoming line connectors
- One drawout three-pole gang-operated line isolation switch assembly with isolating shutter, external operating handle interlocked to prevent opening the medium-voltage compartment door until the isolating switch is open and grounded
- Three vertically mounted current limiting power fuses with pop-up blown fuse indicators
- One magnetic three-pole vacuum contactor with dc operating coils and mechanical interlock to prevent opening the isolation switch when the contactor is closed
- One control power transformer (115 V secondary)
- Two CPT primary current limiting fuses
- Four electrical interlocks (2NO, 2NC)

#### Mounted in the Low-Voltage Compartment

- One control panel with:
  - One EMR-3000 motor protection relay
  - Three interposing relays
- One set of control circuit terminal blocks
  - One control circuit secondary fuse
  - One run-test circuit

#### Reduced Voltage Structure(s)

- One magnetic three-pole vacuum run contactor with dc operating coil and electrically and mechanically interlocked with the starting contactor
- One magnetic two-pole vacuum start contactor with dc operating coil and electrical and mechanical interlocks
- Three current transformers
- One medium-duty starting auto-transformer with 50–65–80% taps
- Three distribution class lightning arresters for high-voltage stress protection on the transformer zero tap

#### Locked Rotor Amps

- Locked Rotor Amps (LRA) must be specified to ensure proper sizing of autotransformer

#### Starting Characteristics

Table 10.3-7. Type 602 Auto-transformer Starting Characteristics

Starter Type	% Motor Voltage	% Motor Current	% Line Current	% Torque
80% tap	80	80	67	64
65% tap <sup>ⓐ</sup>	65	65	45	42
50% tap	50	50	28	25

<sup>ⓐ</sup> Factory set on 65% tap.

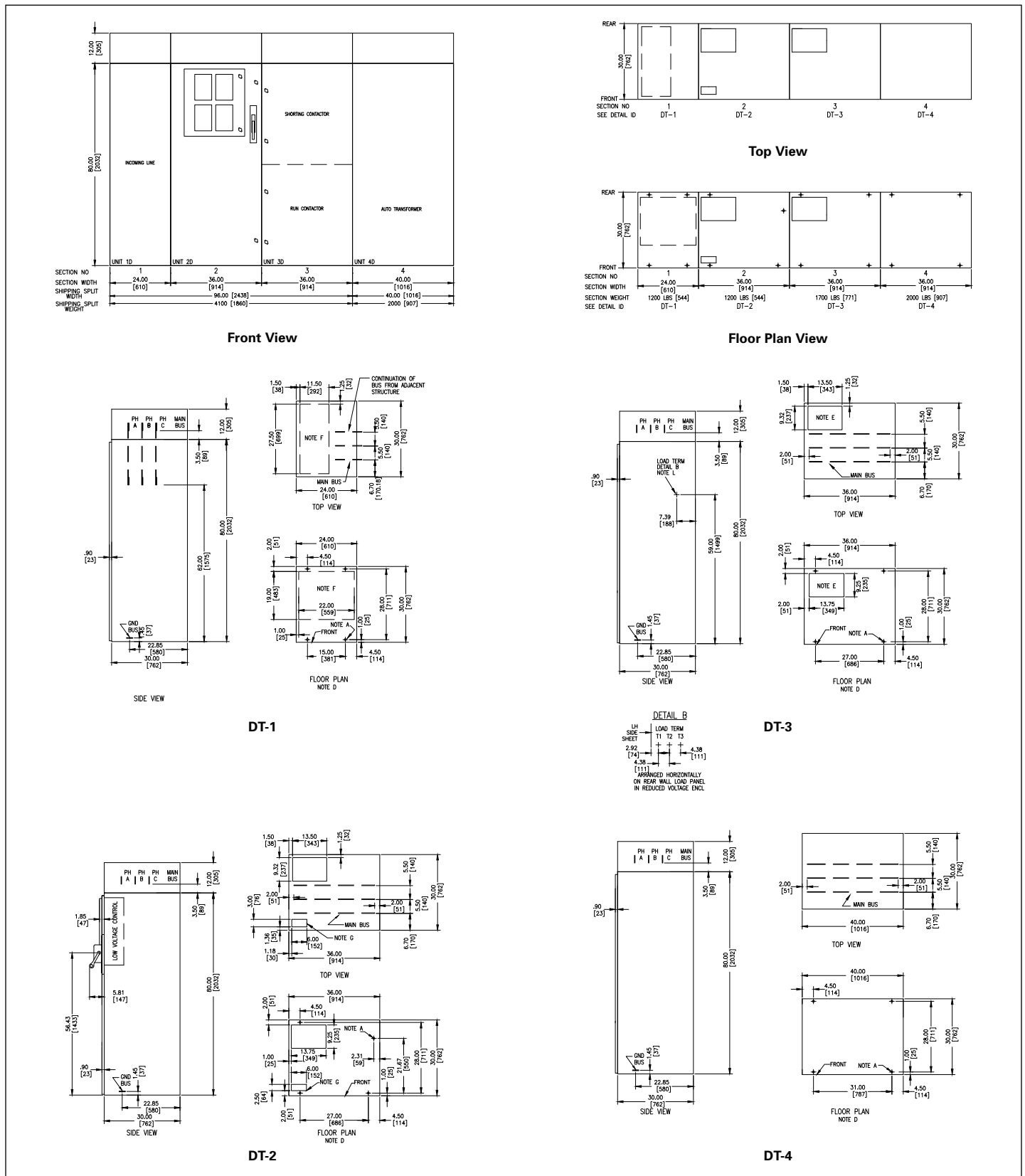

Figure 10.3-6. RVAT Starter—Dimensions in Inches (mm)

**Table 10.3-8. Arrangement Detail Notes**

Note	Description
<b>Cable Notes</b>	
	Starter load connection is designed for maximum of one 500 kcmil or two 350 kcmil.
<b>Arrangement Notes</b>	
A	0.875 dia. typical 4 holes. Mounting studs to extend a maximum of 2.00 inches (50.8 mm) above grade.
B	HV conduit space, load cables for two-high starters. Cables for lower starter enter in front half of conduit space, and cables for upper starter enter in rear half.
B1	HV conduit space, line and load cables for bottom entry stand-alone starters. Line cables should enter in rear half of conduit space, and load cables should enter in front half of conduit space.
C	LV conduit space for two-high starters with bottom entry control conduit. Control wiring for upper starter should enter in left half of conduit space, and lower starter control wiring should enter in right half of conduit space.
C1	LV conduit space for two-high starters with top entry control conduit. Control wiring for upper starter should enter in right half of conduit space, and lower starter control wiring should enter in left half of conduit space.
D	90 ° door swing requires 12.00 inches (304.8 mm) for 12.00-inch (304.8 mm) wide structure, 18.00 inches (457.2 mm) for 18.00-inch (457.2 mm) wide structure, 24.00 inches (609.6 mm) for 24.00-inch (609.6 mm) wide structure, 36.00 inches (914.4 mm) for 36.00-inch (914.4 mm) wide structure and 40.00 inches (1016.0 mm) for 40.00-inch (1016.0 mm) wide structure.
E	HV conduit space, load.
F	HV conduit space, line only.
F1	HV conduit space, line only. Line cables to enter in rear half of conduit space only.
G	LV conduit space only.
L	Load terminations located on rear wall of starter mounted on a load panel. Terminations are arranged horizontally from left to right. T1, T2, T3 left to right at 4.38-inch (111.3 mm) centers.
L1	Load terminations located on rear wall of reduced voltage enclosure mounted on a load panel. Terminations are arranged horizontally from left to right. T1, T2, T3 left to right at 4.38-inch (111.3 mm) centers.
T	HV conduit space, load cables for two-high starters. Cables for lower starter enter in rear half of conduit space, and cables for upper starter enter in front half.
X	Steel bottom with removable lead plates.
Y	Tolerances -0.0 inches +0.25 inches per structure.
Z	Conduits to extend a maximum of 2.00 inches (50.8 mm) into structure.

## Synchronous

### Full Voltage Synchronous Starters, Brush Type Controller Catalog S241 Non-Reversing

#### Mounted in the Medium-Voltage Section

- Three incoming line connectors
- One drawout three-pole gang-operated line isolation switch assembly with isolating shutter. External operating handle interlocked to prevent opening the medium-voltage compartment door until the isolating switch is open and grounded
- Three vertically mounted current limiting power fuses with pop-up blown fuse indicators
- One magnetic three-pole vacuum contactor with dc operating coils and mechanical interlock to prevent opening the isolation switch when the contactor is closed
- One control power transformer (115V secondary)
- Two CPT primary current limiting fuses
- Four electrical interlocks (2NO, 2NC)
- Three current transformers

#### Mounted in the Low-Voltage Compartment

- One control panel with:
  - One EMR-3000 motor protection relay
  - One interposing relay
  - One set of control circuit terminal blocks
  - One control circuit secondary fuse
  - One run-test circuit

#### Mounted in the Upper Compartment or Auxiliary Structure

One brush-type solid-state field panel:

- Mounted on door:
  - One ac line ammeter, panel type
  - One dc field ammeter, panel type
  - One exciter field potentiometer
  - One set of externally ventilated heatsinks
  - One graphic display
- Mounted on inside compartment:
  - One step-down exciter transformer three-phase
  - One "SCR" power supply panel
  - One synchronous control board
  - "MOV" surge protection
  - One three-phase CT
  - One ELC controller
  - One set of control circuit blocks
  - Three primary fuses
  - Three secondary fuses
- Mounted on top of starter:
  - One starting and field discharge resistor



Typical Wiring Diagrams

Full Voltage FVNR Starter

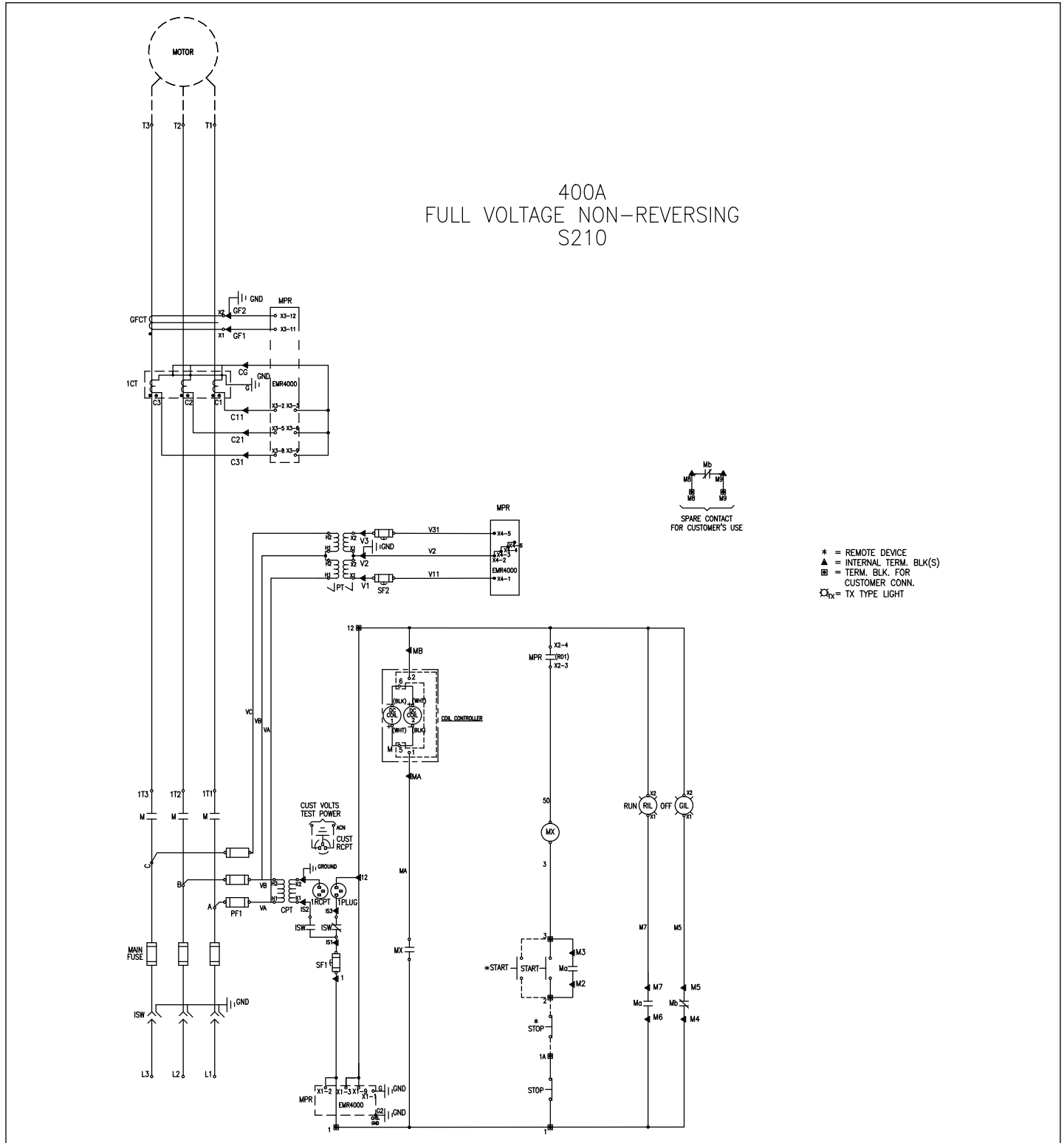

Figure 10.3-7. Induction Motor Across-the-Line Starter, Vacuum Contactor with Optional EMR-4000 Motor Protection, Start-Stop Pushbuttons, and Red and Green Indicating Lights

Reduced Voltage Autotransformer RVAT Starter

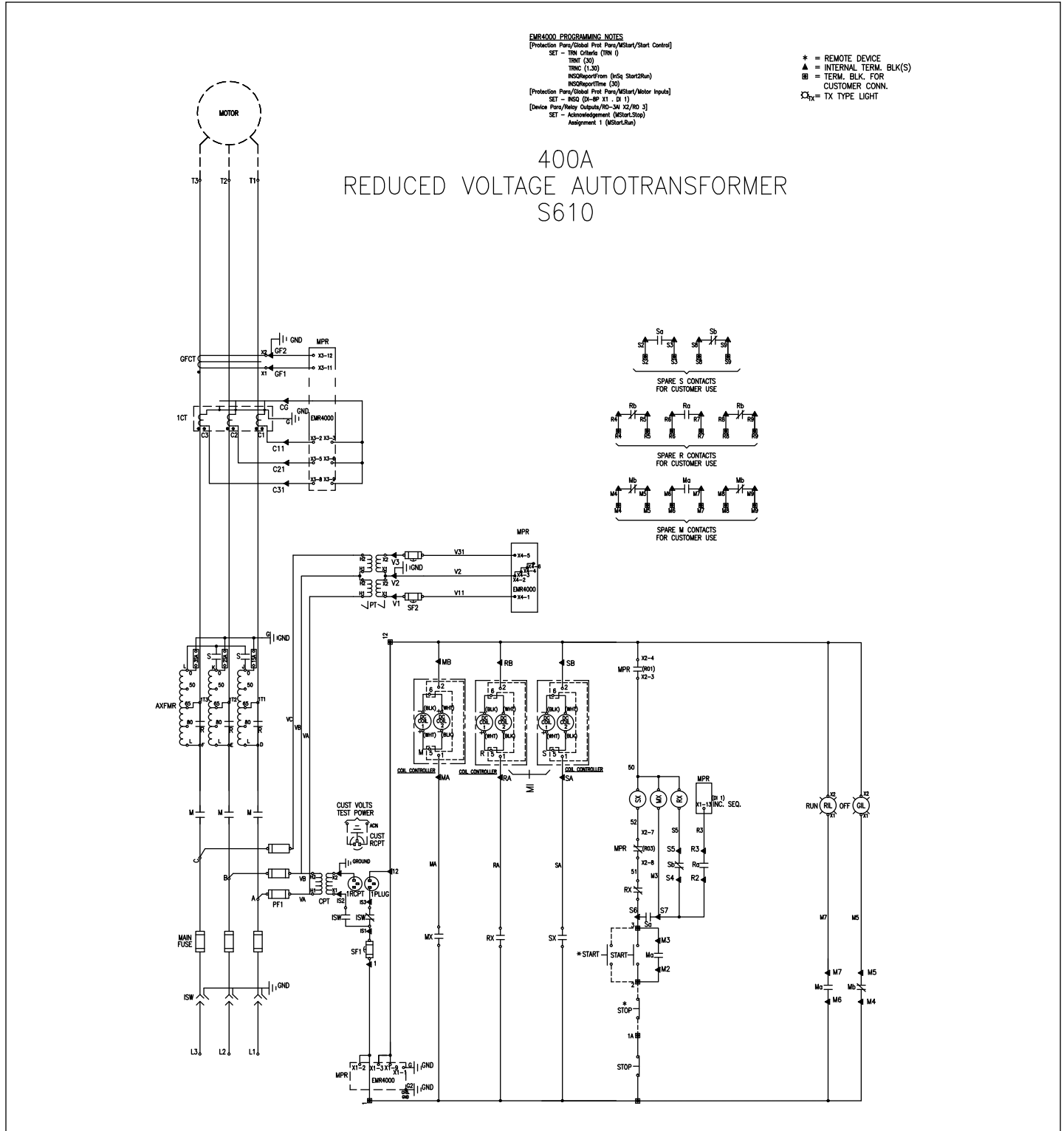

Figure 10.3-8. Induction Motor Reduced Voltage Autotransformer Starter, Vacuum Contactor with Optional EMR-4000 Motor Protection, Start-Stop Pushbuttons, and Red and Green Indicating Lights

## Fuses and Current Transformers

### Starter Fuse Information

Table 10.3-9. R-Rated Fuses—Motor Application

Voltage	Starter Size	FLA-Min.	FLA-Max.	Fuse
15 kV	300 A	1	23.3	40A
		23.4	29.3	50A
		29.4	34.7	65A
		34.8	44	80A
		44.1	56	100A
		56.1	80	125A
		80.1	90.7	150A
		90.8	98.7	175A
		98.8	113.3	200A
		113.4	160	250A
		160.1	200	300A
		200.1	300	400A

**Note:** For motor applications, fuses are sized based on locked rotor amperes of 6-times full load amperes and acceleration time of 10 seconds.

Table 10.3-10. Current Transformer Application

Starter Size	FLA-Min.	FLA-Max.	CT(R:5)
300 A	10	22.9	25
	23	41.9	50
	42	62.9	75
	63	82.9	100
	83	123.9	150
	124	165.9	200
	166	246.9	300
	247	300	400

**Note:** CT class is C5 or higher. All have sufficient burden capability to drive most electronic overload relays.

Table 10.3-11. E-Rated Fuses—Feeder/Transformer Application

Voltage	Starter Size	FLA-Min.	FLA-Max.	Fuse
15 kV	300 A	1	300	400E

**Note:** For feeder (transformer) applications, fuses are sized for transformer full load amperes times 1.4.

## Voltage Transformers

Table 10.3-12. Standard Voltage Transformer, 60 Hz Accuracy

kV Class	Standard Ratios	Burdens at 120V	Thermal Rating VA at 55 °C	Metering VA at 55 °C
15	100, 105, 110, 115, 120	0.3WXYMZ	500	10

Table 10.3-13. Standard Voltage Transformer Ratio Information

Rating—Volts	7200	12,000	12,500	13,200	13,800	14,400
Ratio	60:1	100:1	105:1	110:1	115:1	120:1

## Heat Loss Data

Table 10.3-14. Heat Loss in Watts, at 60 Hz

Contacting Rating	Operating Amperes	Heat Loss
300 A	300 A	400 W

**Eaton**  
 1000 Eaton Boulevard  
 Cleveland, OH 44122  
 United States  
 Eaton.com

© 2020 Eaton  
 All Rights Reserved  
 Printed in USA  
 Publication No. DG020003EN / Z23483  
 February 2020



Eaton is a registered trademark.  
 All other trademarks are property of their respective owners.