

ADE1F2 ADCC

CAP184252

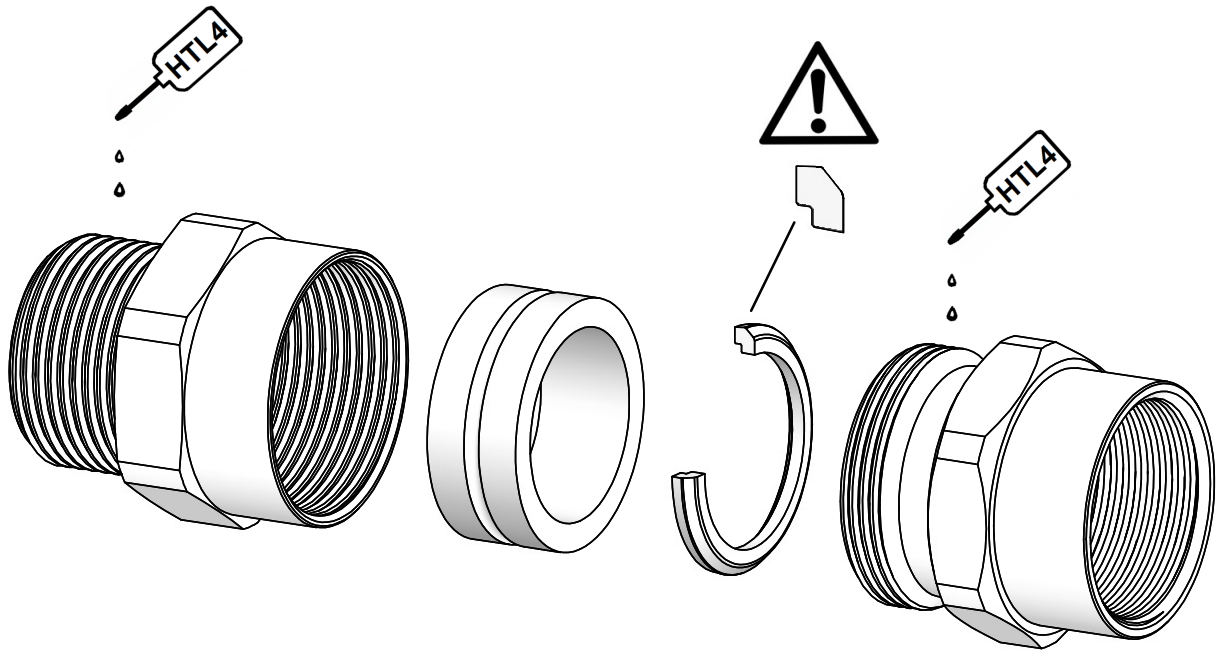

Edition 2017/07 A

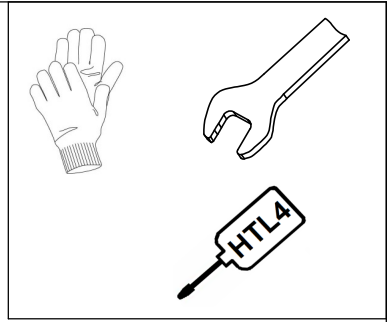
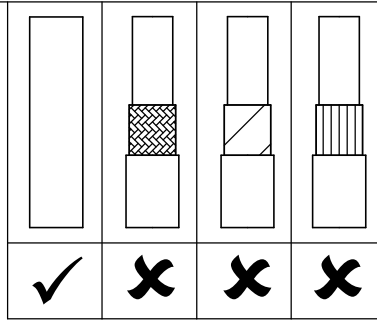

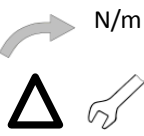
ISO	NPT	 N/m
M10	1/8"	6,5
M12	1/4"	7,5
M16	3/8"	12,5
M20	1/2"	20
M25	3/4"	30
M32	1"	55
M40	1"1/4	75
M50	1"1/2	100
M63	2"	135
M75	2"1/2	175
M90	3"	300
M100	3"1/2	400
M110	4"	480

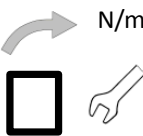
ADE	 A (mm)	 N/m
N°		
3	2,75 - 5,5	6,5
4	4,5 - 8,5	7,5
5	7 - 12	12,5
6	10 - 16	20
7	13,5 - 21	30
8	18 - 27,5	55
9	23 - 34	75
10	29 - 41	100
11	35 - 48	135
12	42 - 56	175
13	50 - 65	240
14	58 - 74	300
15	66 - 83	400
16	75 - 93	480
17	85 - 104	610

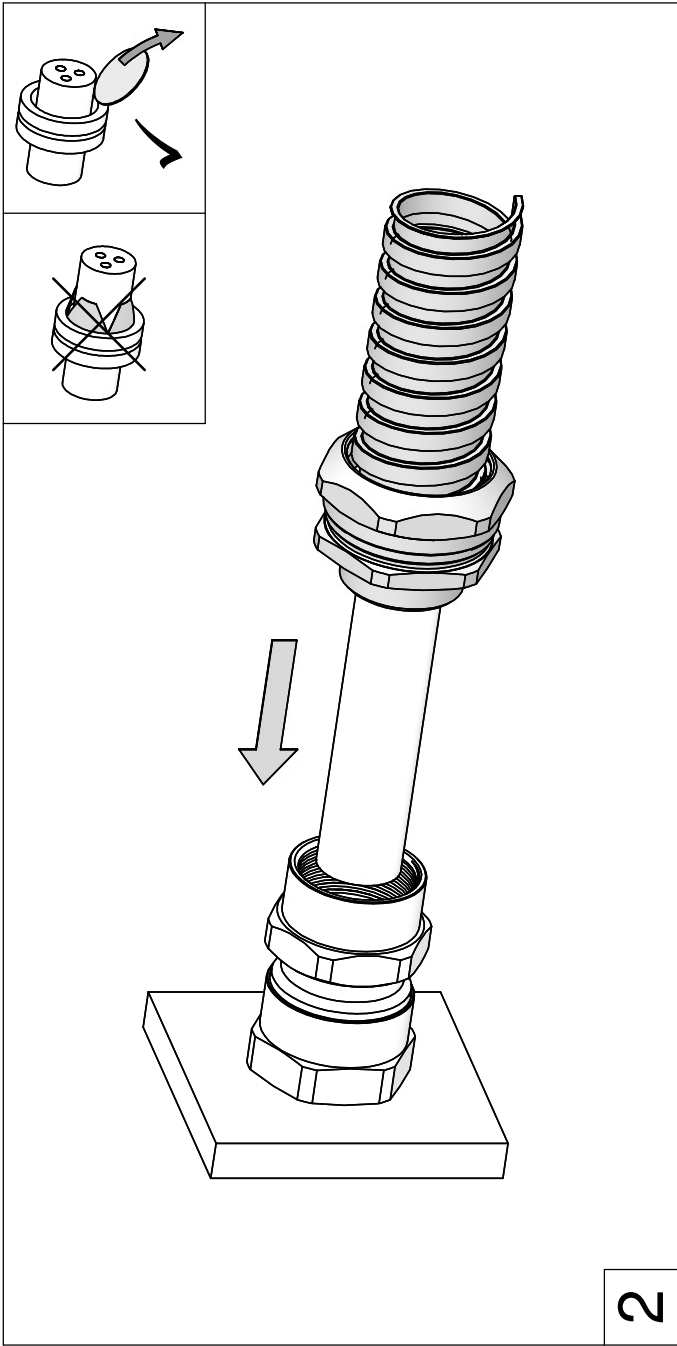

2

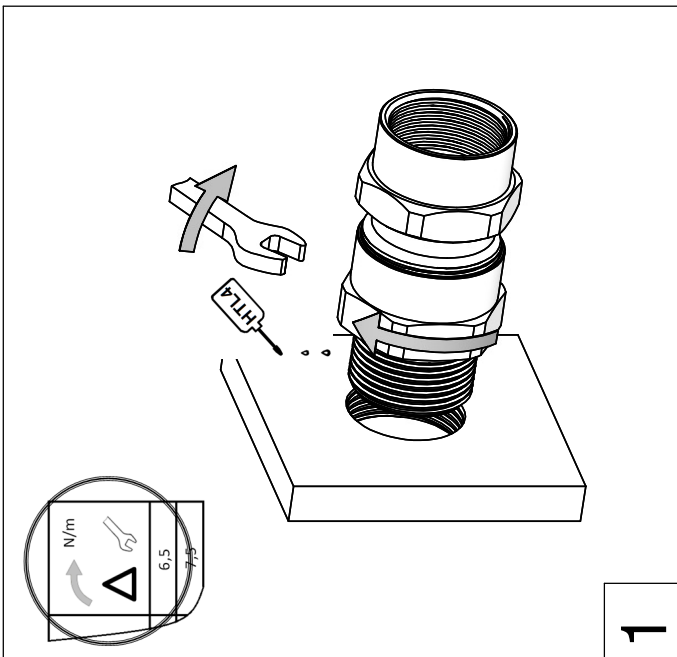

1

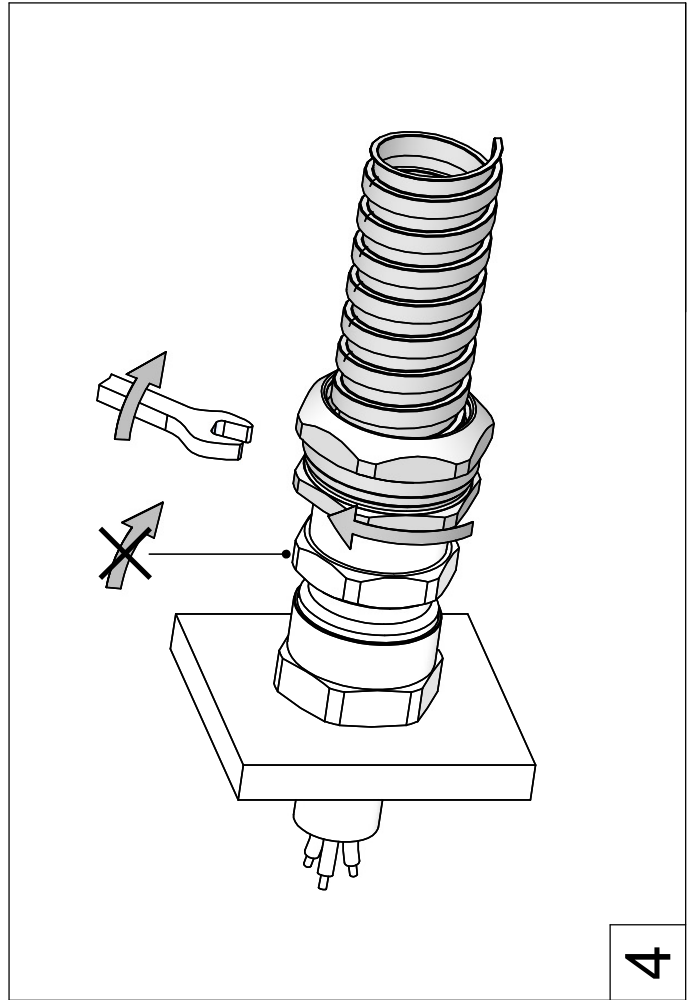

4

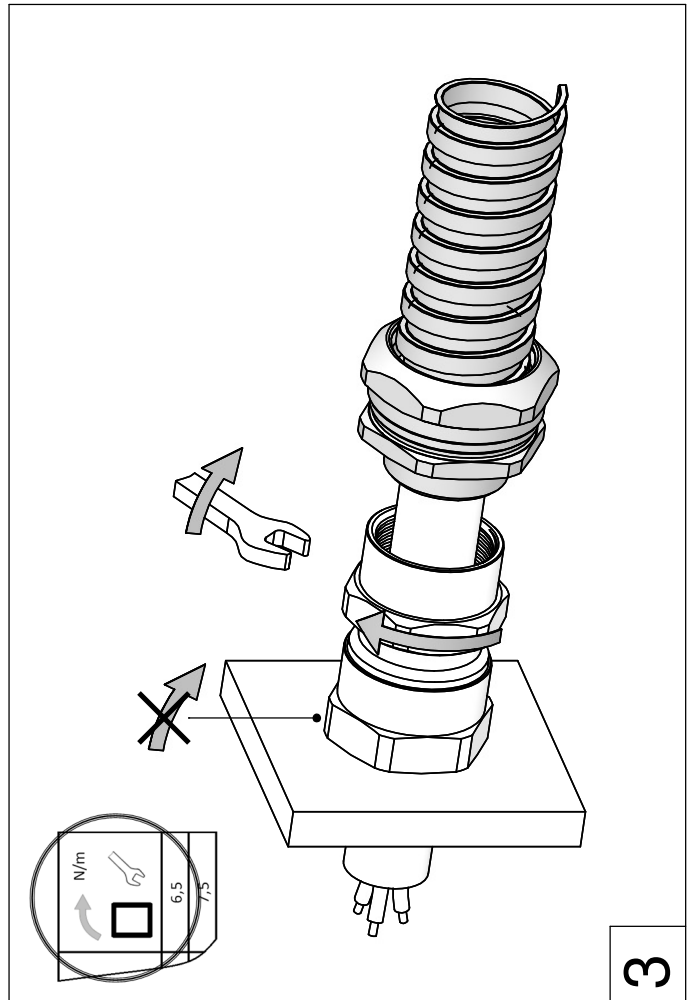

3