

Installation Instructions for Eaton Surge Protective Device XXCNXXX30



Contents

Description	Page
1.0 Setup	2
1.1 Before Installation	2
1.2 Installation	2
1.2.1 DIN Rail Kits	2
1.3 Wiring	2
1.3.1 Series Wiring Applications	3
1.3.2 Parallel Wiring Applications	3
1.4 Apply Power	3
1.5 Specifications	4
1.6 Warranty	4

⚠ WARNING

HAZARDOUS VOLTAGES PRESENT

IMPROPER INSTALLATION OR MISAPPLICATION OF THESE DEVICES MAY RESULT IN SERIOUS INJURY TO INSTALLER AND/OR DAMAGE TO ELECTRICAL SYSTEM OR RELATED EQUIPMENT. READ AND UNDERSTAND ALL INSTRUCTIONS BEFORE BEGINNING INSTALLATION. PROTECTIVE EYEWEAR SHOULD BE WORN WHENEVER WORKING AROUND HAZARDOUS VOLTAGES.

NOTICE

ALL INSTRUCTIONS AND MEASUREMENTS MUST BE COMPLETED BY A LICENSED/QUALIFIED ELECTRICIAN IN ACCORDANCE WITH THE U.S. NATIONAL ELECTRICAL CODE, STATE AND LOCAL CODES OR OTHER APPLICABLE COUNTRY CODES. THE U.S. NATIONAL ELECTRICAL CODE AND STATE AND LOCAL REQUIREMENTS (OR OTHER APPLICABLE COUNTRY CODES) SUPERSEDE THIS INSTRUCTION.

Catalog Number	Voltage Range	Mode	SVR	MCOV	In	SCCR	Peak Surge Current
XXCN02430 ¹	5 - 38 Vdc 5 - 30 Vdc	L-N	N/A	N/A	N/A	N/A	20kA
		L-G					
		N-G					
XXCN04830 ¹	24 - 65 Vdc 24 - 50 Vdc	L-N	N/A	N/A	N/A	N/A	65kA
		L-G					
		N-G					
XXCN12030 ²	48 - 149 Vdc ¹ 100 - 127 Vac	L-N	500	150	5kA	10kA	80kA
		L-G	500	150			
		N-G	500	150			
XXCN23030 ²	150 - 300 Vdc ¹ 128 - 230 Vac	L-N	800	275	3kA	10kA	80kA
		L-G	800	275			
		N-G	800	275			

¹ UL 1449 4th Edition does not list SPD products rated less than 110 Vac or DC voltages.

² UL 1449 4th Edition, UL 1283 7th Edition

1.0 Setup

Verify that system voltages do not exceed those listed in Section 1.5, Specifications.

- All AC measurements should be completed with an RMS voltmeter.
- All DC measurements should be completed with a DC voltmeter.
- **DO NOT INSTALL DEVICE IF MEASURED VOLTAGE EXCEEDS MAXIMUM OPERATION LIMITS.**

Choose location for installation so that maximum separation can be maintained between input leads, output leads and ground leads.

1.1 Before Installation

REMOVE POWER FROM ELECTRICAL SYSTEM BEFORE MOUNTING DEVICE.

- These devices must be mounted within an enclosure to assure personnel safety from exposed terminals.

IMPORTANT

DEVICE SHOULD BE LOCATED SO THAT THE SHORTEST POSSIBLE CONDUCTOR LENGTH MAY BE USED.

- Device should be mounted to allow maximum separation between input and output wiring.
- Device contains no position-oriented components and can be mounted upside down or sideways.
- Device should be placed in electrical circuit so that it is the last device in the circuit before equipment to be protected.

1.2 Installation

DEVICE MUST BE CONNECTED TO ELECTRICAL SYSTEM WITH A CIRCUIT BREAKER:

For AC Applications

- 1 – Single Pole / Single Throw 40A circuit breaker. The Interrupting Rating of the Circuit Breaker Shall Not Be Less Than the Available Fault Current. Circuit Breaker Ratings of 40A, 240V/415V, 10kA Min. AIC Rating.

Note: Pre-existing breaker of the rated load size may be utilized if provision for multi-conductor connections are made according to N.E.C. 110-14A.

- If Neutral wire is to be utilized as NEU/HOT 2 then another circuit breaker should be provided for that phase.

For DC Applications

- DC units to be installed after an overcurrent protective device that is rated not to exceed 100% of the current rating of the unit.

REMOVE POWER FROM ELECTRICAL SYSTEM BEFORE INSTALLING DEVICE.

Mechanically mount device.

- Mount device using mounting flange holes or optional DIN bracket listed below.
- Device should be mounted to allow maximum separation between input and output wiring.
- Device contains no position oriented components and can be mounted upside down or sideways.
- Device should be placed in electrical circuit so that it is the last device in circuit before equipment to be protected.

1.2.1 DIN Rail Kits

Mounting bracket and foot adaptable to DIN Rail systems DIN EN 50022, DIN EN 50035 and DIN EN 50045 are available through Eaton Center and can be ordered separately.

- Eaton Cat# DINRAILKIT-30ACF
- Eaton Innovative Technology Cat# DINRAILKIT-30ITCF

1.3 Wiring

NOTICE

AN INSULATED GROUNDING CONDUCTOR THAT IS IDENTICAL IN SIZE AND INSULATION MATERIAL AND THICKNESS TO THE GROUNDED AND UNGROUNDED CIRCUIT SUPPLY CONDUCTORS, EXCEPT THAT IT IS GREEN WITH OR WITHOUT ONE OR MORE YELLOW STRIPES, IS TO BE INSTALLED AS PART OF THE CIRCUIT THAT SUPPLIES THE DEVICE. SEE TABLE 250-122 OF THE NATIONAL ELECTRIC CODE (NEC) REGARDING THE APPROPRIATE SIZE OF THE GROUNDING CONDUCTOR.

THE GROUNDING CONDUCTOR IS TO BE GROUNDED TO EARTH AT THE SERVICE EQUIPMENT OR OTHER ACCEPTABLE BUILDING EARTH GROUND SUCH AS THE BUILDING FRAME IN THE CASE OF HIGH-RISE STEEL FRAME STRUCTURE.

ANY ATTACHMENT-PLUG RECEPTACLES IN THE VICINITY OF THE DEVICE ARE TO BE GROUNDING TYPE, AND THE GROUNDING CONDUCTORS SERVING THESE RECEPTACLES ARE TO BE CONNECTED TO EARTH GROUND AT THE SERVICE EQUIPMENT OR OTHER ACCEPTABLE BUILDING EARTH GROUND SUCH AS THE BUILDING FRAME IN THE CASE OF HIGH-RISE STEEL FRAME STRUCTURE.

NOTICE

PRESSURE TERMINAL OR PRESSURE SPLICING CONNECTORS AND SOLDERING LUGS USED IN THE INSTALLATION OF THE DEVICE SHALL BE IDENTIFIED AS BEING SUITABLE FOR THE MATERIAL OF THE CONDUCTORS. CONDUCTORS OF DISSIMILAR METALS SHALL NOT BE INTERMIXED IN A TERMINAL OR SPLICING CONNECTOR WHERE PHYSICAL CONTACT OCCURS BETWEEN DISSIMILAR CONDUCTORS UNLESS THE DEVICE IS IDENTIFIED FOR THE PURPOSE AND CONDITIONS OF USE.

CONDUCTORS SHOULD BE TWISTED TOGETHER TO REDUCE IMPEDANCE FACTOR. EXCESSIVE WIRE LENGTH AND SHARP BENDS DEGRADE FILTER PERFORMANCE; THEREFORE, AVOID EXCESSIVE WIRE LENGTH AND SHARP BENDS.

1.3.1 Series Wiring Applications

- Connect incoming system **GROUND** wire to terminal labeled **GND** on unprotected end (labeled as **LINE**).
- Connect load side **GROUND** wire to terminal labeled **GND** on protected end (labeled as **EQUIP**).

For AC Applications

- Connect incoming system **NEUTRAL** wire to terminal labeled **NEU/HOT 2** on unprotected end (labeled as **LINE**).
- Connect load side **NEUTRAL** wire to terminal labeled as **NEU/HOT 2** on protected end (labeled as **EQUIP**).
- Connect incoming system **HOT** wire to terminal labeled **HOT 1** on unprotected end (labeled as **LINE**).
- Connect load side **HOT** wire to terminal labeled as **HOT 1** on protected end (labeled as **EQUIP**).

For DC Applications

- Connect incoming system **NEGATIVE** wire to terminal labeled **NEU/HOT 2** on unprotected end (labeled as **LINE**).
- Connect incoming system **POSITIVE** wire to terminal labeled **HOT 1** on unprotected end (labeled as **LINE**).

1.3.2 Parallel Wiring Applications

IMPORTANT

DEVICE SHOULD BE LOCATED SO THAT THE SHORTEST POSSIBLE CONDUCTOR LENGTH MAY BE USED. CONDUCTORS SHOULD BE TWISTED TOGETHER TO REDUCE IMPEDANCE FACTOR. EXCESSIVE WIRE LENGTH AND SHARP BENDS DEGRADE DEVICE PERFORMANCE; THEREFORE, AVOID EXCESSIVE WIRE LENGTH AND SHARP BENDS.

- Connect incoming system **GROUND** wire to terminal labeled **GND** on unprotected end (labeled as **LINE**).

For AC Applications

- Connect incoming system **NEUTRAL** wire to terminal labeled **NEU/HOT 2** on unprotected end (labeled as **LINE**).
- Connect incoming system **HOT** wire to terminal labeled **HOT 1** on unprotected end (labeled as **LINE**).

For DC Applications

- Connect incoming system **NEGATIVE** wire to terminal labeled **NEU/HOT 2** on unprotected end (labeled as **LINE**).
- Connect incoming system **POSITIVE** wire to terminal labeled **HOT 1** on unprotected end (labeled as **LINE**).

Note: For ungrounded or isolated control transformer secondary, DO NOT CONNECT Ground terminal on either **LINE** or **EQUIP** side.

1.4 Apply Power

Apply power to system. Indicator light should glow. If the light does not glow, remove power and contact supplier.

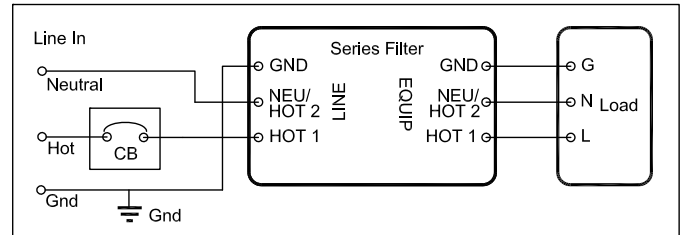

Figure 1. Single Phase Series AC Application

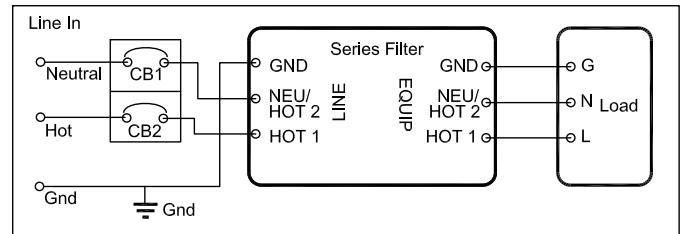

Figure 2. Split Phase Series AC Application (shown with Neutral utilized as NEU/HOT 2)

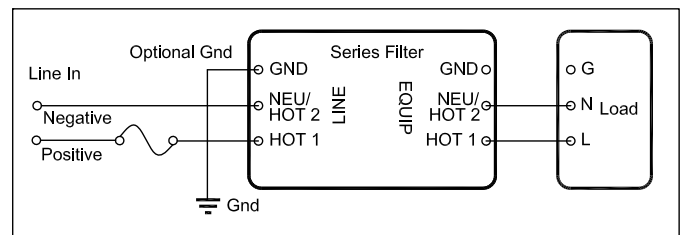

Figure 3. Series DC Application

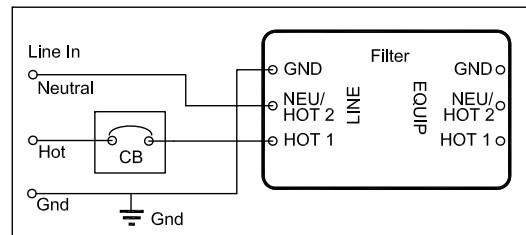

Figure 4. Single Phase Parallel AC Application

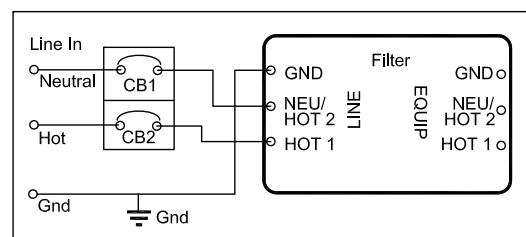

Figure 5. Split Phase Parallel AC Application (shown with Neutral utilized as NEU/HOT 2)

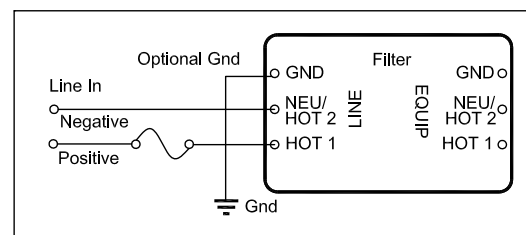

Figure 6. Parallel DC Application

1.5 Specifications

Description	Ratings
Agency Approvals XXCNXXX30	UL1449 4th Edition, UL1283 7th Edition Type 2 SPD
Terminal Connections	Wire clamping terminals, 10-18 AWG (UL), 10-22 AWG (CSA) Torque 12 in-lb
System voltages	
DC	5 - 38 Vdc, 24 - 65 Vdc, 48 - 149 Vdc, 150 - 300 Vdc
AC	100 - 127 Vac, 200 - 230 Vac
Operating Temperature	-40F(-40C) to +140F(+60C)
Circuit Breaker	40A, 240V/415V, 10kA Min. AIC Rating (Eaton P/N:FAZ-C40/1-NA-SP)
Amps*	30
Input Power Frequency	50/60 Hz
Warranty	5 Years, 10 Years if registered on www.eaton.com/spd
RoHS Compliant	Yes

* Amp rating is for series connection only. Parallel connection is not current dependent.

1.6 Warranty

Eaton warrants these products for a period of 5 years from the date of delivery to the purchaser, 10 years if registered on www.eaton.com/spd, to be free from defects in both workmanship and materials. Eaton assumes no risk or liability for results of the use of the products purchased from it, including but without limiting the generality of the foregoing; (1) The use in combination with any electrical or electronic components, circuits, systems, assemblies, or any other materials or substances; (2) Unsuitability of any product for use in any circuit or assembly.

Purchaser's right under the warranty shall consist solely of requiring Eaton to repair, or at Eaton's sole discretion, replace, free of charge, F.O.B. factory, and defective items received at said factory or failure to give any advice or recommendations by Eaton shall not constitute any warranty by or impose any liability upon Eaton. The foregoing constitutes the sole and exclusive liability of Eaton AND IS IN LIEU OF ANY AND ALL OTHER WARRANTIES EXPRESSED, IMPLIED OR STATUTORY AS TO THE MERCHANTABILITY, FITNESS FOR PURPOSE SOLD, DESCRIPTION, QUALITY, PRODUCTIVENESS OR ANY OTHER MATTER.

In no event shall Eaton be liable for special or consequential damages or for delay in performance of the warranty.

This warranty does not apply if the product has been misused, abused, altered, tampered with, or used in applications other than specified on the nameplate. At the end of the warranty period, Eaton shall be under no further warranty obligation expressed or implied.

The product covered by this warranty certificate can only be repaired or replaced by the factory. For help on troubleshooting the Critical Protection Product, or for warranty information, call 1-800-809-2772, Option 4, sub-option 2. Repair or replacement units will be returned collect. If Eaton finds the return to be a manufacturer's defect, the product will be returned prepaid.

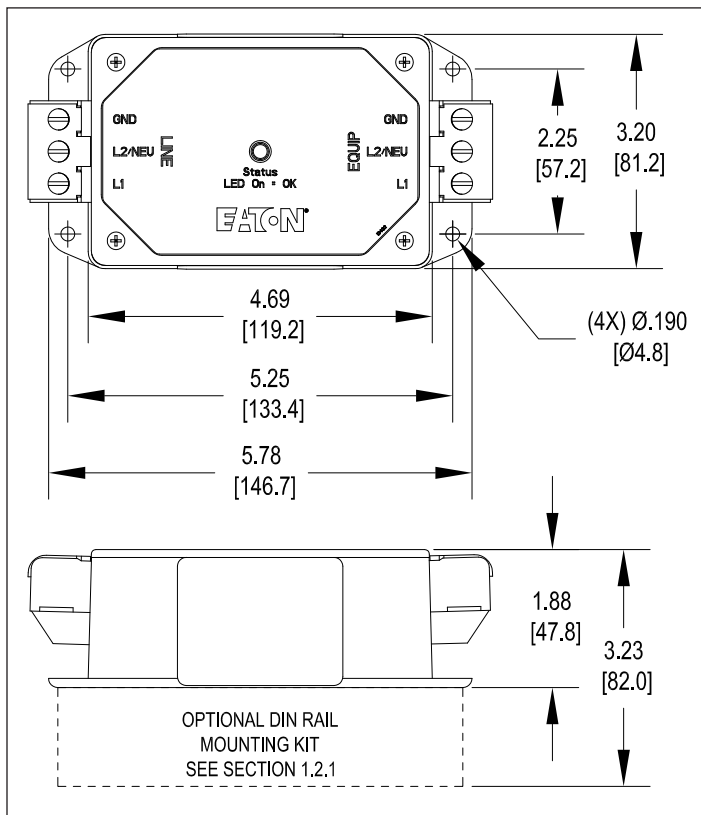

Figure 7. Product Dimensions

Eaton
Electrical Sector
1000 Eaton Boulevard
Cleveland, OH 44122
United States
877-ETN-CARE (877-386-2273)
Eaton.com

© 2018 Eaton
All Rights Reserved
Printed in USA
Publication No. IM01005029E / TBG000471
October 2018

Eaton is a registered trademark.

All other trademarks are property of their respective owners.