

Network Management Card (Network-MS)

User Manual



Network Management Card (Network-MS) User Manual

Contents

1	EATON NETWORK SOLUTION	6
1.1	GENERAL PRESENTATION	6
1.1.1	Connecting the UPS to the Ethernet network	7
1.1.2	Protection of the computers/servers	7
1.1.3	Supervision of the UPSs over the network	8
1.1.4	Connection	8
1.2	PRESENTATION OF THE NETWORK MANAGEMENT CARD (NMC)	10
1.2.1	Compatibility with UPSs	10
1.2.2	Direct sending of E-mail	11
1.2.3	Sending text messages (SMS)	11
1.2.4	Compatibility with the Network Management Systems (NMS) – Trap sending	11
1.2.5	Environment Sensor (option)	11
1.3	TECHNICAL DATA	12
1.3.1	Hardware characteristics	12
1.3.2	EMC Compatibility	12
1.3.3	Configuration	12
1.3.4	Administration	13
1.3.5	Network	13
1.3.6	Environment sensor	14
1.3.7	MIB (Management Information Base)	14
1.3.8	Default parameters	15
2	INSTALLATION	17
2.1	UNPACKING AND CHECK ON CONTENTS	17
2.2	INDICATIONS	17
2.3	INSTALLATION IN THE UPS	18
2.4	SENSOR INSTALLATION (OPTION)	19
3	CONFIGURATION	20
3.1	CONFIGURE IP PARAMETERS	20
3.1.1	Your network is equipped with a DHCPv4 server	21
3.1.2	Your network is not equipped with a DHCPv4 server	22
3.1.3	IPv6 Parameters	22
3.2	TEST AFTER CONFIGURATION	22
4	SUPERVISION AND ADMINISTRATION BY BROWSER	23
4.1	OPTIMISING THE PERFORMANCE OF YOUR BROWSER	23
4.2	UPS	24
4.2.1	UPS properties page	24

Network Management Card (Network-MS) User Manual

4.2.2	On-line help	37
4.2.3	Logging In	38
4.2.4	UPS control	39
4.2.5	UPS weekly schedule programming	41
4.2.6	Shutdown parameters	42
4.2.7	Measurements	44
4.2.8	Event log	45
4.2.9	System log	46
4.3	NOTIFICATION	47
4.3.1	Email Notification	47
4.3.2	E-mail Message Settings	49
4.4	CONFIGURATION	51
4.4.1	Network settings	51
4.4.2	RADIUS	54
4.4.3	LDAP	56
4.4.4	System	59
4.4.5	Notified Applications	60
4.4.6	Central shutdown configuration	63
4.4.7	Access control	64
4.4.8	SNMP Setting	66
4.4.9	Date and time	68
4.4.10	Firmware upload	69
4.5	ENVIRONMENT SENSOR (OPTION)	70
4.5.1	Characteristics	70
4.5.2	Environment Status	71
4.5.3	Environment Settings	72
4.5.4	Log	74
5	SERVER PROTECTION	75
5.1	SET-UP OF THE SHUTDOWN PARAMETERS	75
5.1.1	Shutdown criteria managed by the Network Management Card	75
5.1.2	Controlled outlets	78
5.1.3	Protection of a server connected to a controlled outlet	78
5.2	THE DIFFERENT SERVER AND UPS SHUTDOWN SEQUENCES	80
5.2.1	Extended power outage, shutdown initiated by the Shutdown Timer (Shutdown after)	80
5.2.2	Extended power outage, shutdown initiated by the "Low battery power" message	80
5.2.3	Case of power restoration before the end of the "shutdown duration" counter	81
5.3	SHUTDOWN MANAGEMENT WITH 2 NMC BOARDS	82
5.3.1	Shutdown Duration	82
5.3.2	Settings	82
6	TELNET/SSH/CLI INTERFACES	83

Network Management Card (Network-MS) User Manual

6.1	INTRODUCTION	83
6.2	SETTINGS LIST	83
6.2.1	Network settings	83
6.2.2	System settings	84
6.2.3	Trap receivers	84
6.2.4	Access control	84
6.2.5	Shutdown settings	84
6.2.6	Authentication settings	85
6.2.7	RADIUS settings	85
6.2.8	LDAP settings	85
6.2.9	SNMP settings	86
6.2.10	Date and time	86
6.2.11	Environment settings	86
6.3	MENU INTERFACE	87
6.3.1	Tree description	88
6.3.2	Main menu	89
6.3.3	Reset item	90
6.3.4	Network menu	90
6.3.5	Trap receivers menu	92
6.3.6	System menu	93
6.3.7	Shutdown menu	93
6.3.8	Access Control menu	94
6.3.9	Date and time menu	95
6.3.10	Environment menu	95
6.3.11	Authentication settings	97
6.3.12	Return to default Login/Password	99
6.3.13	Return to default configuration	99
6.4	COMMAND LINE INTERFACE	99
6.4.1	Generic command	100
6.4.2	Network settings	101
6.4.3	Trap receivers	104
6.4.4	System settings	105
6.4.5	Shutdown settings	106
6.4.6	Access control settings	107
6.4.7	Authentication settings	108
6.4.8	Date and time settings	112
6.4.9	Environment settings	113
6.5	CONSTRAINTS/LIMITATIONS	116
7	CONFIGURATION VIA RS232	117
7.1	CHOICE 1: RESTART / RESET	118

Network Management Card (Network-MS) User Manual

7.2	CHOICE 2: NETWORK CONFIGURATION	118
7.2.1	Choice 1: Read IPv4&IPv6 Network settings	118
7.2.2	Choice 2: Modify IPv4 Network settings	119
7.2.3	Choice 3: Set Ethernet speed	119
7.3	CHOICE 3: LOST PASSWORD / SET LOGIN PASSWORD TO DEFAULT	120
7.4	CHOICE 4: RETURN TO DEFAULT CONFIGURATION	121
8	APPENDIX	122
8.1	TABLES OF ALARMS AND EVENTS	122
8.1.1	Table of alarms	122
8.1.2	Table of UPS events	125
8.1.3	Table of system alarms	128
8.2	SNMP OBJECTS	129
8.2.1	IETF MIB	129
8.2.2	EATON Pulsar MIB (ex MGE)	129
8.2.3	TRAPS table: (1.3.6.1.4.1.705.1.11)	133
8.2.4	EATON Powerware MIB	134
8.3	AUTHENTICATION CONFIGURATION EXAMPLE	137
8.3.1	RADIUS	137
8.3.2	LDAP	138
9	GLOSSARY	140

1 EATON Network Solution

1.1 General Presentation

EATON Network Solution:

- Provides information on events concerning the supply of power to the computers connected to your network,
- Carries out automatic shutdown of computer systems,
- Monitors and controls all the UPSs connected to the network.

EATON Network Solution provides 3 main functions:

- Supervision of the UPSs over the Network: Web browser, Intelligent Power Manager, or SNMP Network Management System (NMS).
- Protection of the computers (multi-platform) with Intelligent Power Protector
- Connexion of the UPS to the Network.

Network Management Card (Network-MS) User Manual

1.1.1 Connecting the UPS to the Ethernet network

This function can be performed through network Cards inserted in the UPS (Network Management Card). Also a software "agent" running on a nearby PC that is called the IPP Shutdown controller feature can be used. IPP Shutdown controller feature allows USB or Serial connected UPS to be seen on the network through the PC.

The Network Management Card or Shutdown Controller:

- Manages communication with the UPS (as well as local protection of the machine on which Proxy is installed).
- Periodically accesses the information concerning the UPS.
- Makes this information available to the connected applications (Intelligent Power Protector, Web Browser, Network Management Systems, Intelligent Power Manager).
- Sends notifications on certain events.

Operation may be in standard secure mode (the default mode) or in SSL secured mode (Secure Socket Layer SSL).

1.1.2 Protection of the computers/servers

This function is performed by **Intelligent Power Protector** installed on each of the computers to be protected. Note that Intelligent Power Protector are available on several Operating Systems.

Protection applications:

- Continuously gets information from the **Network Management Card/Proxy** connected to the UPS.
- Warns administrators and users if AC power fails and proceeds to a graceful system shutdown before the end of battery backup power is reached.

Network Management Card (Network-MS)

User Manual

1.1.3 Supervision of the UPSs over the network

Depending on your needs, you can either use:

- Internet browser to monitor each UPS, as IPP Shutdown Controller and Management Card includes a Web server
- Company's standard Network Management System (HP-Openview, CA Unicenter, HP Insight Manager, IBM Tivoli Netview)

To simplify integration of EATON UPSs, use one of the Network Management System Kits for EATON devices. These kits are available on the Software Suite CD-ROM or on the <http://powerquality.eaton.com> website.

- The supervisor "Intelligent Power Manager".

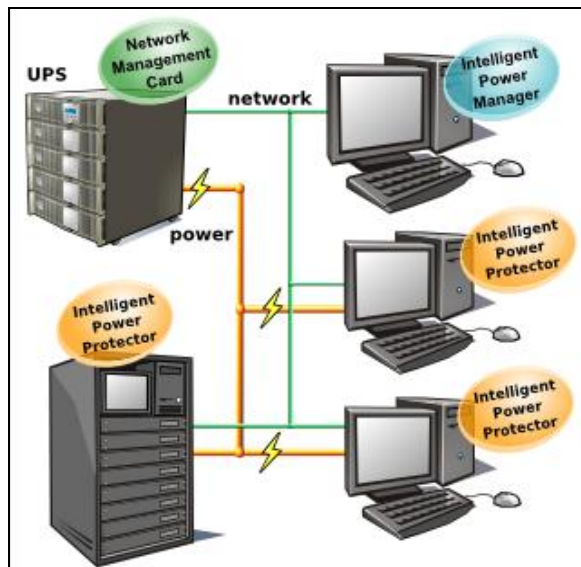

1.1.4 Connection

Before installing the Network Solution, the UPS must be set up as indicated in the steps below.

Shut down the computers to be protected by the UPS.

Connect the UPS to a wall outlet. (For UPSs above 3kVA, please refer to the UPS installation manual).

Connect the power cord of each computer to an outlet on the UPS. (For more details, please refer to the UPS installation manual)

Network Management Card (Network-MS)

User Manual

1.1.4.1 How to connect UPS / agent / network:

Insert the optional NMC communication card in the UPS and connect the UPS to the computer network.
Start the UPS, then the computers.

1.1.4.2 Setting up the protection:

Set up the Network Management Card (see user manual).

Install and configure the protection application on all machines that are to be protected by the UPS:

- Intelligent Power Protector for EATON Pulsar series UPS: The software components for each platform and the user manuals are on the Software Suite CD or available at <http://powerquality.eaton.com>

Network Management Card (Network-MS) User Manual

1.2 Presentation of the Network Management Card (NMC)

1.2.1 Compatibility with UPSs

The Minislot Network Management Card is compatible with the UPS listed into the compatibility list:

Pulsar MX	All models
MX, MX frame	All models
Pulsar M 2200 / 3000	All models
Pulsar 700 / 1000 / 1500	All models
EX 700 / 1000 / 1500 / 2200 / 3000	All models
Evolution 650 / 850 / 1150 / 1550 / 2000	All models
Evolution S 1250 / 1750 / 2500 / 3000	All models
Pulsar Evolution 500 / 800 / 1100	Technical level 06 or higher
Pulsar Evolution 2200 / 3000	Technical level 05 or higher
Pulsar Evolution 1500	Technical level 05 or higher
EXtreme C 700 / 1000 / 1500	Technical level B2 or higher
EXtreme C 2200 - 3200	Technical level 02 or higher
Pulsar EX 700 / 1000 / 1500 RT (US°)	Technical level 03 or higher
Pulsar EX 2200 / 3200 (US°)	Technical level 09 or higher
EX 5 / 7 / 11 RT	Equipped with Minislot port.
Powerware 5130	All models
9120	All models
9130	All models
9135	All models
9170	All models
9E 20000 / 30000 / 40000 / 60000 / 80000 / 100000 / 120000 / 160000 / 200000	All models
9P 50000 / 100000 / 150000 / 200000	All models
5PX 1000 / 1500 / 2000 / 2200 / 3000	All models
5P 550 / 650 / 750 / 850 / 1000 / 1150 / 1500 / 1550 / 2200 / 3000	All models
93PM 50 / 100 / 150 / 200 / 250 / 300 / 350 / 400 / 450 / 500 / 550 / 600 / 650 / 700 / 750	All models
9SX 5000 / 6000 / 8000 / 11000	All models
9PX 5000 / 6000 / 8000 / 11000	All models
9PX 6000 SP / 8000 SP / 10000 SP	All models
9PX 6000i 3 :1 / 8000i 3 :1 / 11000i 3:1	All models

Network Management Card acquires information regarding the operation status of the UPS systems and provides remote control of the system through the ETHERNET network from any SNMP administration station or Web browser.

Network Management Card (Network-MS) User Manual

NMC also supplies alarms to the Intelligent Power Protector in order to trigger shutdowns or manage other automatic actions on protected servers.

1.2.2 Direct sending of E-mail

When a UPS event occurs, the Network Management Card can directly notify up to 4 addresses by e-mail. (see E-mail Notification and [E-mail message settings](#))

1.2.3 Sending text messages (SMS)

SMS notification requires the use of a third-party application that converts emails to SMS. The card offers the possibility of redirecting UPS alarms to an e-mail server. The format of these e-mails is compatible with mobile telephone e-mail/SMS transfer systems proposed by ISPs. The format to be used depends on the service provider.

1.2.4 Compatibility with the Network Management Systems (NMS) – Trap sending

The Network Management Cards are compatible with the major Network Management Systems (IBM Tivoli, CA Unicenter, HP Insight Manager). The Software Suite offering includes the necessary SNMP plug-ins to allow an easy integration in the NMS. Events are notified by SNMP trap.

- NMS can subscribe on page "[Notified Applications](#)"
- The trap list is given in the [appendix](#).

1.2.5 Environment Sensor (option)

The optional [Environment Sensor](#) (EMP) solution can be connected to the Card Settings port of the Network Management Cards.

Environment Sensor enables measurement of temperature and humidity around the UPS, allows managing external alarms via 2 dry contacts and notification of alarms according to pre-programmed thresholds. (see [Environment Status](#) and [Environment Configuration](#))

1.3 Technical data

1.3.1 Hardware characteristics

Dimensions

- Dimensions (L x l x H) 132 x 66 x 42 mm
- Weight (gr) 70 g

Storage

- Storage temperature -10 °C to 70 °C

Ambient conditions

- Operating temperature 0 °C to 40 °C
- Ambient humidity 90 % RH max without condensation
- ROHS 100 % compatible

1.3.2 EMC Compatibility

When correctly installed and used in accordance with the manufacturer's instructions, the Network ManagementCard complies with the following standards:

- Safety for ATI: IEC/EN 60950-1 2005
- EMC: EN 61000-6-2 (2002), EN 61000-6-3 (2002). IEC/EN 62040-2 (2002).

As per European directives:

- Low voltage: 73/23/EEC and 93/68/EEC
- EMC: 89/336/EEC and 93/68/EEC.

1.3.3 Configuration

- The NMC Card can be easily installed while the UPS is online, maintaining the highest system availability

The user can configure the card with one of the following means:

- Web browser
- Telnet/SSH/CLI
- Local serial link (network parameters)
- BOOTP/DHCP (network parameters).

1.3.4 Administration

- NEW features:
 - External User Authentication from RADIUS or LDAP
- Up to 35 workstations (in TCP connected mode) or up to 100(in UDP broadcasted mode) protected by Intelligent Power Protector.
- Up to 5 browsers connected at the same time (3 in SSL).
- Minimum recommended browser versions: Internet Explorer 8, Mozilla Firefox 3.6, Chrome.
- E-mail sending configurable according to UPS alarms and transmission of a periodical report.
- Control of UPS on/off switching via the HTML interface.
- Adjustment and control of PowerShare outlets via the HTML interface, sequential starting of the installation and optimisation of backup time by shutting down non-priority systems.
- Automatic data and time adjustment via NTP server.
- Protection by encrypted password.
- Protection by secure SSL connection.
- Backup logs in the non-volatile memory.
- Languages available: English / French/ Spanish / German / Italian / Chinese Traditional / Chinese Simplified / Japanese / Portuguese / Russian / Korean / Czech.
- On-line help in English available for each page.
- Card firmware update via the network.
- Card Mass settings via the network with Intelligent Power Manager.
- Firmware Mass Upgrade via the network with Intelligent Power Manager.
- Ability to change the SMTP, SNMP and TRAP ports.

1.3.5 Network

Fast ETHERNET 10/100 Mb/s compatibility with auto-negotiation on the RJ45 outlet.
Compatible with 1Gb/s networks in 100 Mb/s mode

1.3.5.1 List of ports used

Protocol	Direction	Type	Port Number
SSH	in	TCP	22
TELNET	in	TCP	23
SMTP	out	TCP	25*
HTML	out	TCP	80
NTP	in/out	UDP	68, 67
BootP, DHCP	in/out	UDP	68, 67
SNMP V1 & V3	in/out	UDP	161*
TRAP SNMP	in/out	UDP	162*
SSL	out	TCP	443

Network Management Card (Network-MS)

User Manual

IPP in connected mode	in/out	TCP	5000
IPP in UDP broadcast mode	in/out	UDP	4679, 4680R
RADIUS	out	UDP	1812*
LDAP	out	TCP	389*

* These ports can be changed by the user, the values shown are the defaults defined by the standards.

1.3.6 Environment sensor

- Temperature measurement from 0 to 70 °C with +/- 1 °C accuracy.
- Measurement of humidity from 0 to 100 % with +/- 6 % accuracy.
- Min / max time-stamped function for temperature and humidity.
- Choice of temperature readings in Celsius or Fahrenheit.
- High and low thresholds, hysteresis and offset adjustable via Web interface.
- Possibility of notification of status changes by e-mail, SMS or SNMP trap.
SMS notification requires the use of a third-party application that converts emails to SMS.
- Position detection of 2 dry contacts (maximum sensor/contact distance: 20 m).
- Name and status of each configurable contact.
- Recording of events and measurements in the card log
- Possibility of shutting down the installation in the event of a threshold being exceeded or on opening / closure of a dry contact
- Connection to the card with straight shielded CAT5 RJ45 network cables (maximum card/sensor distance: 10 m)

1.3.7 MIB (Management Information Base)

- The card is Compatible with following MIBs:
- MIB II (RFC 1213)
- Internet Engineering Task Force (IETF) Standard UPS MIB (RFC 1628)
- EATON Pulsar MIB (ex MGE) V1.7
- EATON Powerware MIB (PowerMib)
-
- See the [appendix](#) Chapter

Network Management Card (Network-MS) User Manual

1.3.8 Default parameters

Function	Parameter	Default value	Possible value
Network	IP address	192.168.1.2	Network IP address
	Subnet mask	255.255.0.0	Network IP address
	Gateway Address	0.0.0.0	Network IP address
	BOOTP/DHCP	Enabled	Active / Deactivated
	IPv6 Enabled	Disabled	Active / Deactivated
	IPv6 Auto Config Enabled	Disabled	Active / Deactivated
	Firmware Upload	Enabled	Active / Deactivated
	SMTP server	smtpserver	49 characters maximum
	Port	25	1 to 65535
RADIUS	Port	1812	1 to 65535
	Time Out	10	1 to 9999
	Retry Number	3	1 to 9999
LDAP	Authentication Mechanism	Simple	Simple or by digest MD5
	User Search	Anonymous	Anonymous or by a dedicated LDAP user
	Authorization Mode	None	None/by attribute/by group
	Port	389	1 to 65535
System	UPS Contact	Computer Room Manager	49 characters maximum
	UPS Location	Computer Room	31 characters maximum
	History log interval (sec.)	60	10 to 99999 sec.
	Environment log interval (sec.)	300	10 to 99999 sec.
	Default Language	English	English / French / Spanish / German / Italian / Chinese Traditional / Chinese Simplified / Japanese / Portuguese / Russian / Korean / Czech
Notified Application table		empty	NA
Access control	User name	admin	10 characters maximum
	Password	admin	10 characters maximum
	Telnet access enabled	Enabled	Enabled/Disabled
	Telnet security enabled	Disabled	Enabled/Disabled
	Console interface	Menu	Menu/CLI
	External Authentication	None	
	Authentication Order	Local First, then External	
	Session duration without activity	300 seconds	
	Maximum sessions duration	9999 seconds	

Network Management Card (Network-MS) User Manual

SNMP	Community name read SNMP port Trap port SNMP Version Read-Only User Read-Only Security Level Read-Only Password Read-Write User Read-Write Security Level Read-Write Password Notification Username	public 161 162 V1&V3 readuser Authentication readuser writeuser Authentication&Privacy writeuser notifuser	32 characters maximum 1 to 65535 1 to 65535 Disabled,V1,V3,V1&V3 1 character minimum, 32 characters maximum None, Authentication, Authentication&Privacy 8 characters minimum, 24 characters maximum 1 character minimum, 32 characters maximum None, Authentication, Authentication&Privacy 8 characters minimum, 24 characters maximum 8 characters minimum, 24 characters maximum
Date and time	Date and time adjustment NTP server	Accept automatic update from IPP or IPM ntpserver	Synchronise with an NTP server Accept automatic update from NSM or EPM Synchronise manually 49 characters maximum
Serial link	Speed Data bits Stop bits Parity Flow control	9600 baud 8 1 without without	Not configurable Not configurable Not configurable Not configurable Not configurable

2 Installation

2.1 Unpacking and check on contents

The installation kit contents:

- A Network Management Card (Network-MS)
- A serial communication cable for configuration (720-C2270-00)
- Installation manual (34003905)

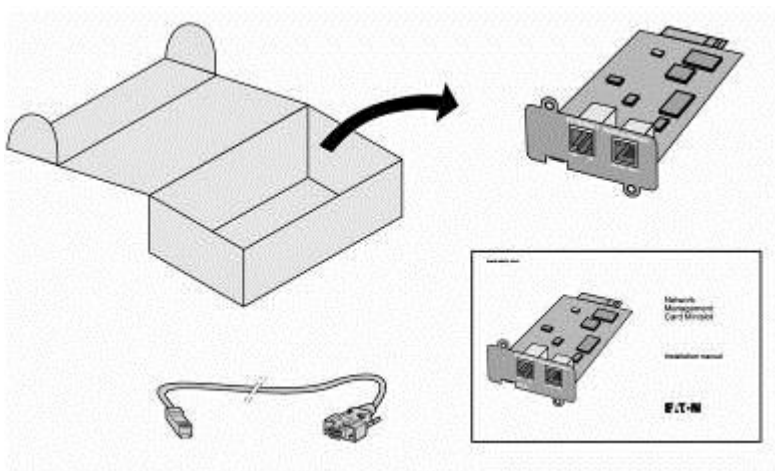

2.2 Indications

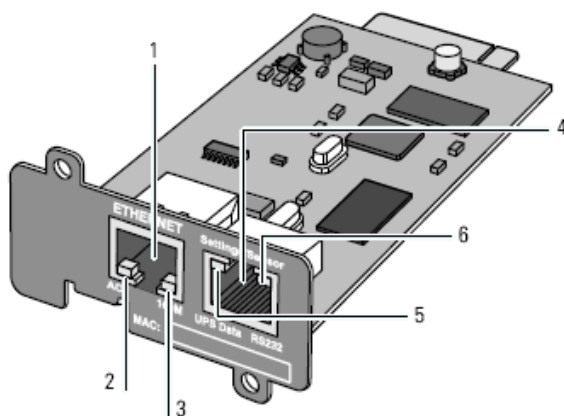

1. Ethernet Port (10/100BaseT)
2. ACT LED (green)
3. 100M LED (orange)
4. Settings/Sensor Port
5. UPS Data LED (green)
6. RS232 LED (orange)

Network Management Card (Network-MS)

User Manual

Ethernet Port

LED	Colour	Activity	Description
ACT	Green	• Off	• Card not connected to the network.
		• On	• Card connected to the network but without activity
		• Flashing	• Port is active in receiving / transmission
100M	Orange	• Off	• Port operating at 10Mbits/s.
		• On	• Port operating at 100Mbits/s.

Settings/Sensor Port

LED	Colour	Activity	Description
UPS Data	Green	• Off	• Card startup in progress.
		• On	• Communication with UPS in progress
		• Flashing	• Normal operation. Communication with the UPS is operational
RS232	Orange	• Off	• Configuration menu is active
		• On	• Normal operation. Configuration menu is deactivated
		• Flashing	• Communication with the Environment Sensor (option).

2.3 Installation in the UPS

The **Network Management Card (Network-MS)** is "hot-swappable". It can be installed in all UPSs of the EATON Pulsar series or EATON Powerware series equipped with a Minislot without having to shut it down.

- On the UPS, remove the cover from the Minislot

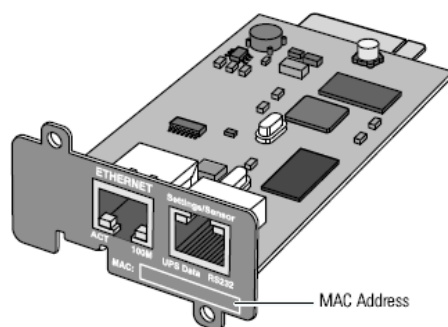

- Insert and tighten the card's retaining screws
- Connect the ETHERNET cable
- Wait 2min 30s. The card is completely operational when the green UPS Data LED flashes continuously.

2.4 Sensor installation (option)

The Environment sensor is available as an option for the Network Management Card and is available from EATON (EMP).

The sensor allows remote monitoring of the UPS's environment through regular measurements: temperature, humidity, status of two external contacts. It also enables notification of alarms (e-mail, trap SNMP) according to pre-programmed thresholds.

It is connected to the Service port (Settings/Sensor) directly on the Network Management Card with a standard Ethernet cable (10 meters maximum).

Recognition is automatic. Supervision and configuration are performed via a menu that can be accessed directly from the home page.

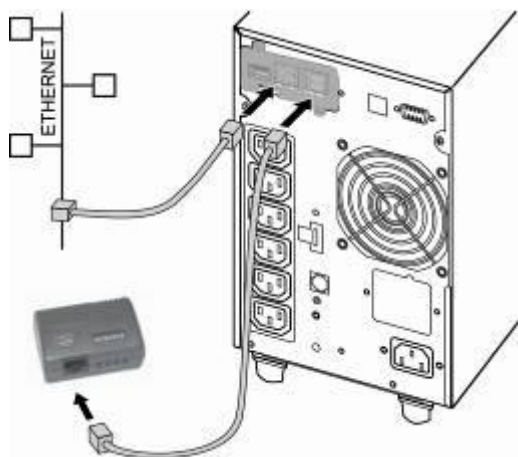

3 Configuration

3.1 Configure IP parameters

Once the card has started:

Connect one end of the cable (34003918) to the Service port.

Connect the other end of the cable to the COM port (IOIOI) of a PC.

Launch a HyperTerminal™ type emulator with the following configuration:

Speed: 9600

Data bits: 8

Parity: none

Stop bits: 1

Flow control: none

"Locally reproduce the characters entered" option: deactivated.

Enter admin. The main menu is displayed:

```
-----  
EATON  
NETWORK MANAGEMENT CARD  
-----  
1 : Reset  
2 : Network configuration  
3 : Set Login Password to Default  
4 : Return to Default Configuration  
0 : Exit  
-----
```

3.1.1 Your network is equipped with a DHCPv4 server

The card is configured by default with this service activated.

The card automatically collects IP parameters.

To know the IP parameters, type 2, the next menu is displayed:

```
-----  
Network settings  
-----  
1 : Read Network settings  
2 : Modify Network settings  
3 : Set Ethernet speed  
0 : Exit  
-----
```

Then type 1. The menu is displayed:

```
Network configuration :  
MAC address : 00:20:85:FD:1C:07  
Mode : Static IP  
IP address : xxx.xxx.xxx.xxx  
Subnet mask : xxx.xxx.xxx.xxx  
Gateway : xxx.xxx.xxx.xxx  
Link Local IPv6 address : xxxx::xxxx:xxxx:xxxx:xxxx /xx  
Global IPv6 address : xxxx:xxxx:xxxx:xxxx:xxxx:xxxx:xxxx:xxxx /xx  
Global IPv6 address : xxxx:xxxx:xxxx:xxxx:xxxx:xxxx:xxxx:xxxx /xx
```

Note the IP address.

The IPv6 parameters are only read only.

To exit, enter 0 then 0. The card is operational.

Note: As long as the card is not connected to the network, it continuously attempts to make connection. Once the connection has been established, the operational mode presented in the table above becomes effective.

3.1.2 Your network is not equipped with a DHCPv4 server

In the main menu enter 2, then 2 again. The menu is displayed:

Follow the instructions and enter the static IP parameters.

At the end of the menu, wait for the "Done" message to be displayed indicating that the IP parameters have been saved.

```
-----  
Network settings  
-----  
 1 : Read Network settings  
 2 : Modify Network settings  
 3 : Set Ethernet speed  
 0 : Exit  
-----  
For each of the following questions, you can press <Return> to select the  
value  
shown in braces, or you can enter a new value.  
Should this target obtain IP settings from the network?[N] N  
Static IP address [xxx.xxx.xxx.xxx]? xxx.xxx.xxx.xxx  
Static IP address is xxx.xxx.xxx.xxx  
Subnet Mask [xxx.xxx.xxx.xxx]? xxx.xxx.xxx.xxx  
Subnet Mask is xxx.xxx.xxx.xxx  
Gateway IP address [xxx.xxx.xxx.xxx]? xxx.xxx.xxx.xxx  
Gateway IP address is xxx.xxx.xxx.xxx  
Wait during your new configuration is saved ...  
Reset the card to take into account the new configuration.
```

Return to the main menu and enter 1 then 2.

The card restarts with the new IP parameters.

3.1.3 IPv6 Parameters

The IPv6 parameters are read only through the serial line configuration menu. If IPv6 is enabled, all IPv6 addresses of the card can be read from the HyperTerminal™. The "Your network is equipped with a DHCPv4 server" chapter describes the steps to follow to display this addresses.

3.2 Test after configuration

To check that the Network Management Card is operational after installation and configuration:

- From a station connected to the same subnet as the card, open a web browser and enter the IP address of the card in the address field
- Check the display of the [home page](#).

4 Supervision and administration by browser

- On a computer equipped with a Web browser (Internet Explorer, FireFox, Google chrome or Opera recommended), enter the address initialised previously in the Installation chapter.
- The "UPS properties" home page is displayed.

4.1 Optimising the performance of your browser

- To view status changes on the UPS in real time, the browser must be configured so that it automatically refreshes all the objects on the current page.

Example on IE 8: Tools / Internet Options / General / Parameters menu, tick Every time this page is visited and validate.

4.2 UPS

4.2.1 UPS properties page

- Essential information about the UPS status is available on the UPS Properties page (see Figure), which refreshes automatically every ten seconds.
- The UPS Properties page shows an image and generic name of the UPS range. You can customize Computer Room to name the location of your system (see “System Settings”).
- An animated diagram displays for online UPSs showing an overview of the current UPS operating mode.

Powerware 9130 700 - Computer Room

UPS Properties Help

Powerware 9130 700
Computer Room



UPS Status ▼

Power source :	AC Power
Output load level :	0%
Output :	Master: On Group1: On Group2: On
Battery	
Battery load level :	94 % Charging
Remaining backup time :	6 h 02 mn 48 s
Battery status :	OK

Last update : 2013/03/25 16:20:12

4.2.1.1 UPS status icons.

The various icons showing the status of the UPS are:

	Normal operation
	Alarm present. This icon links directly to the alarm page.
	Loss of communication with the UPS

Animated synoptic: An animated synoptic gives a global overview of the UPS current operating mode. This synoptic is available on all On-Line UPS.

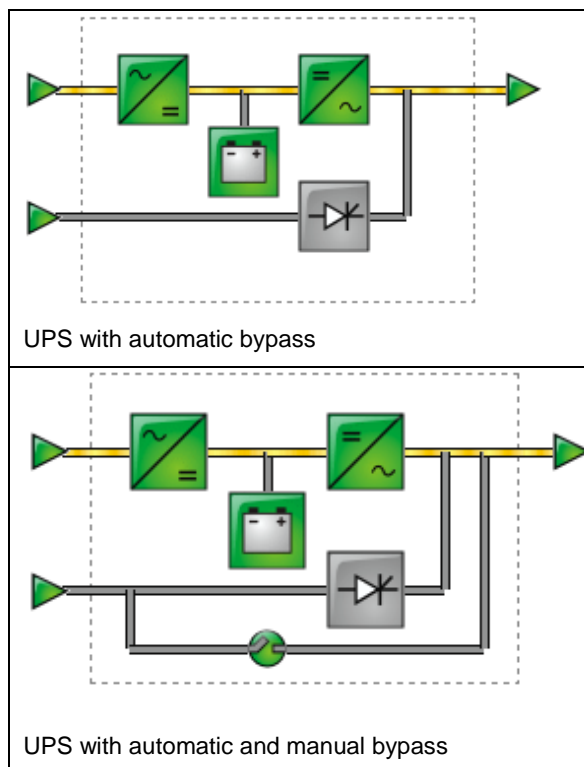

The synoptic drawing depends on the UPS topology. The different drawings are described in the table below.



Note: In case of loss of communication with the UPS, all the elements of the synoptic are grey.

The various elements of the synoptic are the following ones:



- AC Normal Input:

	Green	In tolerances
	Gray	Out of tolerances



Network Management Card (Network-MS)

User Manual



- AC Normal Flow:

	Yellow	AC to DC converter powered by AC Normal
	Gray	AC to DC converter not powered by AC Normal



- AC to DC Converter:

	Green	Powered
	Gray	Not powered
	Red	Internal failure



- Battery:

	Green	Remaining capacity > 50%
	Orange	Remaining capacity < 50%
	Red	Low battery when UPS is on Battery Battery to be checked (battery test result)

- Battery Output Flow:

	Yellow	DC to AC converter powered by battery
	Gray	DC to AC converter not powered by battery



- DC to AC Converter Input flow:

	Yellow	Energy flow present
	Gray	No energy flow



Network Management Card (Network-MS)

User Manual



- DC to AC Converter :

	Green	Powered
	Gray	Not powered
	Red	Internal failure

- DC to AC Converter Output:



	Yellow	Energy flow present
	Gray	No energy flow

- AC Bypass Input:



	Green	In tolerances
	Red	Out of tolerances

•



- AC Automatic Bypass Flow :

	Yellow	Energy flow present
	Gray	No energy flow



- AC Automatic Bypass Status:

	Green	Powered
	Gray	Not powered
	Red	Internal failure

- AC Manual Bypass Flow:

	Yellow	Energy flow present
	Gray	No energy flow



- AC Manual Bypass Status:

	Green / Gray	Open
	Red / Yellow	Closed



Network Management Card (Network-MS)

User Manual

- AC Output Flow:

	Yellow	Energy flow present
	Gray	No energy flow (or Load = 0%)

- AC Output:

	Green	Load protected
	Red	Load not protected

Network Management Card (Network-MS) User Manual

- UPS measurements :

Place the cursor over an element in the diagram to display the UPS measurement detail (see Figure). These measurements are available for Input, Battery, Output, and Bypass mode. The available measurements depend on the UPS range.

Powerware 9130 700 - Computer Room

UPS Properties

Powerware 9130 700
Computer Room

AC Output	
Voltage	230 V
Current	0.0 A
Frequency	49.0 Hz
Load level	0 %
Apparent Power	0.0 kVA

UPS Status

Power source : AC Power

Output load level : 0%

Output :
Master: On
Group1: On
Group2: On

Battery

Battery load level : 94 % Charging

Remaining backup time : 6 h 03 mn 04 s

Battery status : OK

Last update : 2013/03/25 16:24:45



4.2.1.2 UPS status

- **Active sources:** (available on parallel or modular UPS)
 x UPS + y UPS redundant : x indicates the minimal number of UPS necessary to power the load, y indicates the number of UPS in redundancy.

An alarm can be generated if the number of UPS in redundancy is less than a configurable threshold. See UPS modules section.

- **Power source:** indicates whether the power comes from the utility or from the UPS battery
- **Output load level:** indicates the power percentage used at UPS output
- **Output:** indicates if the different UPS outputs are protected.
- **Master:** indicates if the UPS main output is protected
- **Group1** and **Group2:** indicates if the controlled outlets (if available) are powered.

The various icons showing the status of the UPS outputs are:

 (green outlet)	Outlet powered
 (red outlet)	Outlet not powered or not protected

Battery Information:

- **Battery load level:** remaining battery charge (in percent).
 The information is completed with the 3 following labels:
 - **Charging:** if the utility power is present and the battery charge is in progress.
 - **Discharging:** if the UPS operates on battery.
 - **Fault:** if the battery is faulty.
- **Remaining backup time:** Estimation of the battery's maximum backup time remaining before UPS shutdown
- **Battery status:** Result of the last automatic battery test carried out by the UPS
 Possible values are:
 - **OK:** the test was completed correctly.
 - **NOK:** the battery needs to be checked.
 - **Deactivated:** the automatic battery test is not validated on the UPS.

Network Management Card (Network-MS)

User Manual

4.2.1.3 Viewing the modules (Only with Eaton MX Frame UPS)

- Click on **UPS Modules** scroll list to view the information about the UPS modules.

The screenshot shows the 'Network Management Card' interface for an 'MX Frame 16U Computer Room'. The interface is divided into several sections:

- UPS Properties:** Shows a schematic diagram of the UPS system with input and output lines.
- UPS Status:** A dropdown menu.
- Active sources:** 0 UPS + 0 UPS redundant
- Power source:** AC Power
- Output load level:** 0%
- Output:** Master: On, Group1: On, Group2: On
- Battery:**
 - Battery load level: 100% Charging
 - Remaining backup time: 5 h 49 mn 29 s
 - Battery status: OK

Last update : 2011/07/27 09:53:59

- **Active sources:**
 $x \text{ UPS} + y \text{ UPS redundant}$: x indicates the minimal number of UPS necessary to power the load, y indicates the number of UPS in redundancy.



The addition of these 2 values is the total number of available UPS.

- The **Minimum redundant UPS modules to trigger alarm** can be configured from this page. The button **Save** makes the card setting the parameter into the UPS. A warning message informs the user about the consequences of this parameters modification.
 The redundancy lost can generate Email notification (if set in the email notification page) and SNMP trap. It can also be used by IPP for server protection criteria.
- The **Module Nr** gives the location of the module in the UPS.

Network Management Card (Network-MS)

User Manual

- The **Status** can take the next forms:

 or  when the module is working properly with no alarm.

 when the module has at least one alarm (level Warning) active.

 when the module has at least one alarm (level Critical) active.

 when the module has a communication fault.

When the module is working properly with no alarms, the icon is not reactive, otherwise it is reactive and clicking on it makes the page Alarm Table appear.

- **Output load level:** Value of the percentage of load at module output
- **Battery load level:** Percentage of charge available in the battery module

4.2.1.4 Viewing the power usage

Click on **Power usage** scroll list to view the information about the consumptions.

- **Average power usage:** indicates the average consumption on the last hour of each output. The sum of these 3 consumptions is also given.
- **Cumulative power usage:** indicates the consumption cumulated of each output since the last reset. The sum of these 3 consumptions is also given.

Note: The consumptions are only available with UPS Eaton 5PX, 5P, 9PX and 9P. The consumption of each output is only available with UPS Eaton 5PX and 5P.



The displaying is the following :

Power Usage			
Output	Average power usage	Cumulative power usage	
Master	0 Wh	0.00 kWh 2012/09/14 09:51:00	<input type="button" value="Reset"/>
Group1	0 Wh	0.00 kWh 2012/09/14 09:51:00	<input type="button" value="Reset"/>
Group2	0 Wh	0.00 kWh 2012/09/14 09:51:00	<input type="button" value="Reset"/>
Total	0 Wh	0.00 kWh 2012/09/14 09:51:00	<input type="button" value="Reset"/>

4.2.1.5 Viewing the alarms

Click on "Alarm Table" scroll list to view the list of current alarms. The table of managed alarms is included in the [appendix](#).

The level of the alarms appears like below:

-  Critical
-  Warning
-  Unknown

- Alarm table for standard UPS:

Powerware 9130 700 - Computer Room

UPS

- UPS Properties
- UPS Control
- Weekly Schedule
- Shutdown Parameters

Logs and Notification

- Measurements
- Event Log
- System Log
- Email Notification

Settings

- Network
- Radius
- LDAP
- System
- Notified Applications
- Access Control
- SNMP
- Time
- Firmware Upload

UPS Properties Help



Powerware 9130 700
Computer Room



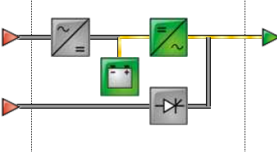

UPS Alarms	Alarm Time	Alarm Description	Severity
UPS	2013/03/25 16:26:21	Normal AC switch open	⚠
	2013/03/25 16:26:21	Normal AC NOK	⚠
	2013/03/25 16:26:32	Normal AC voltage out of tolerance	⚠
	2013/03/25 16:26:32	Normal AC voltage too low	⚠
	2013/03/25 16:26:32	Bypass AC voltage out of tolerance	⚠
	2013/03/25 16:26:32	UPS on battery	⚠

Network Management Card (Network-MS)

User Manual

- Alarm table for modular UPS:

The screenshot displays the Eaton Network Management Card interface. On the left is a navigation menu with sections for UPS, Logs and Notification, and Settings. The main area is titled 'UPS Properties' and shows a diagram of an 'MX Frame 16U Computer Room' UPS system. Below the diagram is a table of 'UPS Alarms'.

	Alarm Time	Alarm Description	Severity
UPS	1970/01/01 00:01:09	Load not protected - On Automatic Bypass	⚠

Network Management Card (Network-MS)

User Manual

4.2.1.6 Viewing the “About your UPS” page

Click on **About your UPS** scroll list to view the information about the UPS and the card.

EATON
Powering Business Worldwide

Powerware 9130 700 - Computer Room

UPS Properties

Powerware 9130 700
Computer Room

About your UPS

UPS Name :	Powerware 9130 700
UPS Part Number :	103006433-6591
UPS Serial Number :	GB371A1058
UPS Technical Level :	unknown
System Technical Level / Firmware Revision :	1.28

Network Management Card

Card Firmware revision :	JA
Card Commercial Reference :	NetworkMS
Card Technical Level :	15
Card Revision :	HE
Card Serial Number :	301C26592
Card Ethernet Mac Address :	00:20:85:F5:79:24
Card Ethernet Speed :	100 MBit
System Clock Frequency :	55 MHz

4.2.2 On-line help

On-line contextual help in English is available at the top of each page by clicking on the Help link, which is always located on the top right corner. The navigation menu of the on-line help is identical to that of the card's pages.

The Help page always opens a new window.



Powerware 9130 700 - Computer Room

- UPS
 - UPS Properties
 - UPS Control
 - Weekly Schedule
 - Shutdown Parameters
- Logs and Notification
 - Measurements
 - Event Log
 - System Log
 - Email Notification
- Settings
 - Network
 - Radius
 - LDAP
 - System
 - Notified Applications
 - Access Control
 - SNMP
 - Time
 - Firmware upload

UPS Properties Help

The UPS Properties page is the default page and displays the basic status of the UPS.

At the top of the page, the UPS is identified: image, name, and location.

The symbol that displays above the UPS image indicates the UPS status. Click the symbol to go to the UPS Alarm page.

- Red - Alarm present
- Green - No active alarm

Electric diagram of the UPS displays the main parts of the UPS and shows the electrical flow that powers the load.

Note: the electric diagram is not available for a line-interactive UPS.

The second segment of the page refreshes every 10 seconds and displays information determined by your selection in the combo box.

UPS Status selects the main status of the UPS:

Active sources shows the current use of a modular UPS, the notation x UPS + y UPS is meaning : x is the number of modules necessary to power the load, y is the number of redundant modules.

Power source shows where the power originates.

Output load level displays the load level.

Output displays the status and the average consumption on the last hour (only available with UPS Eaton 5PX) of all UPS outputs.

UPS Modules selects the status of the modules of the UPS, available only for modular UPS:

Each module of the UPS has static informations as the serial number, or dynamic information as the global status shown with an alarm icon and also its percent load and battery level.

UPS Alarms displays all the active alarms present on the UPS.

Power Usage displays information related to UPS consumption (in Wh or kWh). For each parameter, the user is allowed to reset the timestamp:

Average Power Usage displays the average of power usage in Wh. If available, this information is provided for each output and also summed over all outputs.

Cumulative power usage displays the cumulative power usage in kWh, since the last reset. If available, this information is provided for each output and also summed over all outputs. The user is allowed to reset the timestamp

About your UPS displays all the static informations identifying the UPS and the NMC card.

4.2.3 Logging In

By default, the user name and password are both admin for the local account (see Figure). If an external authentication is used, the username and password will be those defined in LDAP or RADIUS authentication depending on the type chosen.



Both the user name and password fields accept up to a maximum of ten characters. After five minutes have elapsed, or if the browser is closed and reopened, you must re-enter the user name and password. An error in either field results in rejection of the requested action (such as save, page access, or card reboot). After three unsuccessful login attempts, you must refresh the browser. Both the user name and password fields are encrypted with an MD5 type algorithm, ensuring total security.

See "[Set Login Password to Default](#)" to reset the password (from RS232 serial link).

4.2.4 UPS control



NOTE If you are not already logged on, you will be prompted to enter your user name and password before accessing this page.

UPS configuration may prevent the shutdown and restart commands from being properly run. Read the UPS user manual for more information.

Output	Status	Control	Off Delay	Toggle Duration	On Delay
Master	On	None	0 sec	0 sec	0 sec
Group1	On	None	0 sec	0 sec	0 sec
Group2	On	None	0 sec	0 sec	0 sec

This page enables triggering of [startup and shutdown sequences](#) for the UPS main output and controlled outlets.

- The status of each output is displayed by a symbol associated with the Off label (red symbol) or On (green symbol).
- The shutdown sequences take into account the time required for the registered servers to shut down without losing data ([see shutdown parameters](#)).
- The main outlet has priority over the controlled outlets. Shutdown of the main outlet causes the controlled outlets to shut down. Controlled outlets can only be started if the master outlet is on.

The system proposes six different commands, and a command is only actually started after clicking on **Execute**:

- **Safe power down:** A sequence to switch off output power is launched immediately. The systems supplied are shut down correctly while the shutdown sequence is running, then the output is cut.
- **Safe power down & reboot:** A sequence to switch off then restore output power is launched immediately. The powered systems are shut down correctly during the shutdown sequence, then the output is switched off.
- Finally, the restart sequence is launched at the end of the time delay specified in the "Toggle duration" parameter. The output status is updated.

Network Management Card (Network-MS) User Manual

- **Immediate On:** A sequence to switch on output power is launched immediately. The output is re-powered and the systems supplied start up correctly.
- **Delayed, safe power down:** This is the same switch off sequence as for the "Safe power down" command, but postponed by the number of seconds programmed in the "Off Delay" parameter.
- **Delayed, safe power down & reboot:** This is the same switch off then on sequence as for the "Safe power down & reboot" command, but postponed by the number of seconds programmed in the "Off Delay" parameter.
- **Delayed On:** This is the same switch on sequence as for the "Immediate On" command, but postponed by the number of seconds programmed in the "On Delay" parameter.

The **Save** button saves the Off Delay, Toggle duration and On Delay parameters on the card.

4.2.5 UPS weekly schedule programming

Click on the **Weekly schedule** section of the menu.



NOTE *If you are not already logged on, you will be prompted to enter your user name and password before accessing this page.*



Powerware 9130 700 - Computer Room

UPS Help

- UPS Properties
- UPS Control
- Weekly Schedule
- Shutdown Parameters

Weekly Schedule Computer Room

Powerware 9130 700

Day	Shutoff Time	Restart Time
Sunday	22:00	-
Monday	-	06:30
Tuesday	-	-
Wednesday	-	-
Thursday	-	-
Friday	-	-
Saturday	-	-

Logs and Notification

- Measurements
- Event Log
- System Log
- Email Notification

Settings

- Network
- Radius
- LDAP
- System
- Notified Applications
- Access Control
- SNMP
- Time
- Firmware Upload

UPS configuration may prevent the shutdown and restart commands from being properly run. Read the UPS user manual for more information.

The weekly schedule enables the administrator to optimise power consumption or program a reboot of the protected equipment at a set time.

In a shutdown sequence, the **Intelligent Power Protector** connected to the card are informed and ensure that each machine is shut down correctly before the UPS output is switched off. Up to 7 UPS shutdown sequences can be programmed in one week, with a minimum shutdown delay of 30 minutes.

The On / Off sequences are valid only if the card's time has been properly set.

4.2.6 Shutdown parameters



NOTE If you are not already logged on, you will be prompted to enter your user name and password before accessing this page.

This page enables viewing and configuration of UPS operating parameters in battery mode and for power restoration.

Click on the **Shutdown parameters** section in the menu to see the list of parameters.

EATON Powering Business Worldwide

Powerware 9130 700 - Computer Room

UPS

- UPS Properties
- UPS Control
- Weekly Schedule
- Shutdown Parameters

Logs and Notification

- Measurements
- Event Log
- System Log
- Email Notification

Settings

- Network
- Radius
- LDAP
- System
- Notified Applications
- Access Control
- SNMP
- Time
- Firmware Upload

Output	On battery	System Shutdown	Restart
Master	Shutdown if Remaining time under: 180 sec if Capacity under: 20 % <input type="checkbox"/> after: 30 min	Shutdown duration: 120 sec	If Capacity exceeds: 0 %
Group1	Switch Off after: 900 sec if Capacity under: 75 %	Shutdown duration: 120 sec	Switch On after: 30 sec
Group2	Switch Off after: 1800 sec if Capacity under: 66 %	Shutdown duration: 120 sec	Switch On after: 30 sec

Show advanced parameters

Save modified settings : Save

When you tick the **Show advanced parameters** option, extra parameters are displayed. These parameters enable, in particular, adjustment of certain thresholds related to the percentage of remaining battery charge level.

The Output column enables each outlet to be named (maximum 20 characters).

Note

As priority is given to the main outlet, the card cannot supply the controlled outlets when main outlet power is off.

Network Management Card (Network-MS) User Manual

For the main outlet ("Master" by default)

The first shutdown criteria initiates the restart of the [shutdown sequence](#).

- **If remaining time is under** (0 to 99999 seconds, 180 by default) is the minimum remaining backup time from which the shutdown sequence is launched.
- **If battery capacity is under** (0 to 100%); this value cannot be less than that of the UPS and is the minimum remaining battery capacity level from which the shutdown sequence is launched.
- **Shutdown after** (0 to 99999 minutes, not validated by default) is the operating time in minutes left for users after a switch to backup before starting the shutdown sequence.
- **Shutdown duration** (120 seconds by default) is the time required for complete shutdown of systems when a switch to backup time is long enough to trigger the shutdown sequences. It is calculated automatically at the maximum of Shutdown duration of subscribed clients but can be modified in the Advanced mode.
- **If battery capacity exceeds** Minimum battery level to reach before restarting the UPS after utility restoration

Important: Certain UPSs do not support this option

For the controlled outlets ("group 1 or group 2" by default)

The page enables programming of operation time and level in backup mode to manage outlet load shedding in the event of electric power failure:

- **Switch Off after** (from 0 to 99999, 65535 by default) defines the time during which the outlet is supplied starting from the moment of utility failure. Caution, this time includes the outlet shutdown duration.
- **Switch Off if battery capacity under** (0 by default) is an extra condition for outlet shutdown that can trigger the shutdown sequence before the shutdown duration runs out.
- **Shutdown duration** is the time required for complete shutdown of the systems supplied by the outlet when an outlet shutdown sequence is launched.
It is calculated automatically using the maximum shutdown durations of notified applications on the outlets.
- **Switch On after** (from 0 to 99999, default 65535) is the period between main output startup and startup of the relevant programmable outlet, therefore outlet startup can be delayed in relation to the main output.

Important: Certain UPSs do not support this option

4.2.7 Measurements

Click on "Measurements" in the menu

- The next window shows the measurements for a single phase UPS.

EATON Powering Business Worldwide

Powerware 9130 700 - Computer Room

UPS | **Measurements** | **Help**

UPS Properties | UPS Control | Weekly Schedule | Shutdown Parameters

Save Log | Clear Log

Date	Time	AC Normal		AC Output				Battery	
		Voltage	Frequency	Voltage	Frequency	Power(kVA)	Load level(%)	Capacity(%)	Remaining time(mn)
2013/03/26	03:23:32	241	49.0	230	49.0	0.0	0	100	385
2013/03/26	03:24:31	241	49.0	230	50.0	0.0	0	100	385
2013/03/26	03:25:32	242	50.0	230	49.0	0.0	0	100	385
2013/03/26	03:26:32	242	50.0	230	49.0	0.0	0	100	385
2013/03/26	03:27:32	242	50.0	230	50.0	0.0	0	100	385
2013/03/26	03:28:33	242	50.0	230	50.0	0.0	0	100	385
2013/03/26	03:29:33	242	50.0	229	50.0	0.0	0	100	385
2013/03/26	03:30:34	242	50.0	230	50.0	0.0	0	100	385
2013/03/26	03:31:34	241	49.0	230	50.0	0.0	0	100	385
2013/03/26	03:32:34	242	49.0	230	49.0	0.0	0	100	385
2013/03/26	03:33:35	241	49.0	230	50.0	0.0	0	100	385
2013/03/26	03:34:34	242	50.0	230	50.0	0.0	0	100	385
2013/03/26	03:35:35	242	50.0	230	50.0	0.0	0	100	385

Logs and Notification

- Measurements
- Event Log
- System Log
- Email Notification

Settings

- Network
- Radius
- LDAP
- System
- Notified Applications
- Access Control
- SNMP
- Time
- Firmware Upload

The following measurements are saved and time-stamped (About. 430):

- AC Normal : Voltage:** Value of the utility voltage supplying the UPS
- AC Normal : Frequency:** Value of the utility frequency supplying the UPS
- AC Output : Voltage:** Value of the output voltage of your UPS
- AC Output : Frequency:** Value of the output frequency of your UPS
- AC Output : Power (kVA):** Value of the output power of your UPS
- AC Output : Load level (%):** Value of the percentage of load at UPS output
- Battery : Capacity (%):** Percentage of charge available in the battery
- Battery : Remaining time (mn):** Estimation of the remaining backup time
- The save frequency of these values is defined in the "System" page (60 seconds by default). Approximately 435 time-stamps are stored permanently on the card. The oldest time-stamps are automatically deleted.
- Save Log** enables all saved values to be opened or saved in CSV format. (compatible with Excel type spread sheets)
- Clear Log** enables deletion of all records. Enter the login/password to validate this action.

Network Management Card (Network-MS) User Manual

4.2.8 Event log

- Click on **Event Log** in the menu

EATON
Powering Business Worldwide

Powerware 9130 700 - Computer Room

Event Log Help

Powerware 9130 700 Computer Room

Date	Time	Event Description
2013/03/25	16:26:21	Normal AC switch open
2013/03/25	16:26:21	Normal AC NOK
2013/03/25	16:26:32	Normal AC voltage out of tolerance
2013/03/25	16:26:32	Normal AC voltage too low
2013/03/25	16:26:32	Bypass AC voltage out of tolerance
2013/03/25	16:26:32	UPS on battery
2013/03/25	16:26:32	System shutdown in 4 h 45 mn 44 s
2013/03/25	16:26:32	Outlet group 1 shutdown in 13 mn 00 s
2013/03/25	16:26:32	Outlet group 2 shutdown in 28 mn 00 s
2013/03/25	16:31:02	Normal AC switch closed
2013/03/25	16:31:02	Normal AC OK
2013/03/25	16:31:12	Normal AC voltage OK
2013/03/25	16:31:12	Bypass AC voltage OK
2013/03/25	16:31:12	UPS on normal AC
1970/01/01	00:00:00	UPS communication restored

- **Save log** enables all saved values to be opened or saved in CSV format. (compatible with Excel type spread sheets)
- **Clear log** enables deletion of all records. The administrator must enter his/her login / password to validate this action.

The card can save 435 events. The table of managed alarms is included in the [appendix](#).

4.2.9 System log

- Click on **System log** in the menu

The screenshot shows the Eaton Network Management Card interface. The top left features the Eaton logo and the tagline "Powering Business Worldwide". The top right displays "Powerware 9130 700 - Computer Room". Below this is a navigation menu with sections: UPS (UPS Properties, UPS Control, Weekly Schedule, Shutdown Parameters), Logs and Notification (Measurements, Event Log, System Log, Email Notification), and Settings (Network, Radius, LDAP, System, Notified Applications, Access Control, SNMP, Time, Firmware Upload). The main content area is titled "System Log" for "Powerware 9130 700" and includes "Save Log" and "Clear Log" buttons. A table of log entries is shown below:

Date	Time	Event Description
2013/03/25	17:02:00	Network Management Card startup
2013/03/26	09:14:53	Time changed by user with 2013/03/26 09:14:49

- **Save log** enables all saved values to be opened or saved in CSV format. (compatible with Excel type spread sheets)
- **Clear log** enables deletion of all records. The administrator must enter his/her login / password to validate this action.

The card can save 435 events. The table of managed alarms is included in the [appendix](#).

4.3 Notification

4.3.1 Email Notification



NOTE If you are not already logged on, you will be prompted to enter your user name and password before accessing this page.

The card offers the possibility of redirecting UPS alarms to an e-mail server. The format of these e-mails is compatible with mobile telephone transfer systems using text messages (SMS).

SMS notification requires the use of a third-party application that converts emails to SMS.

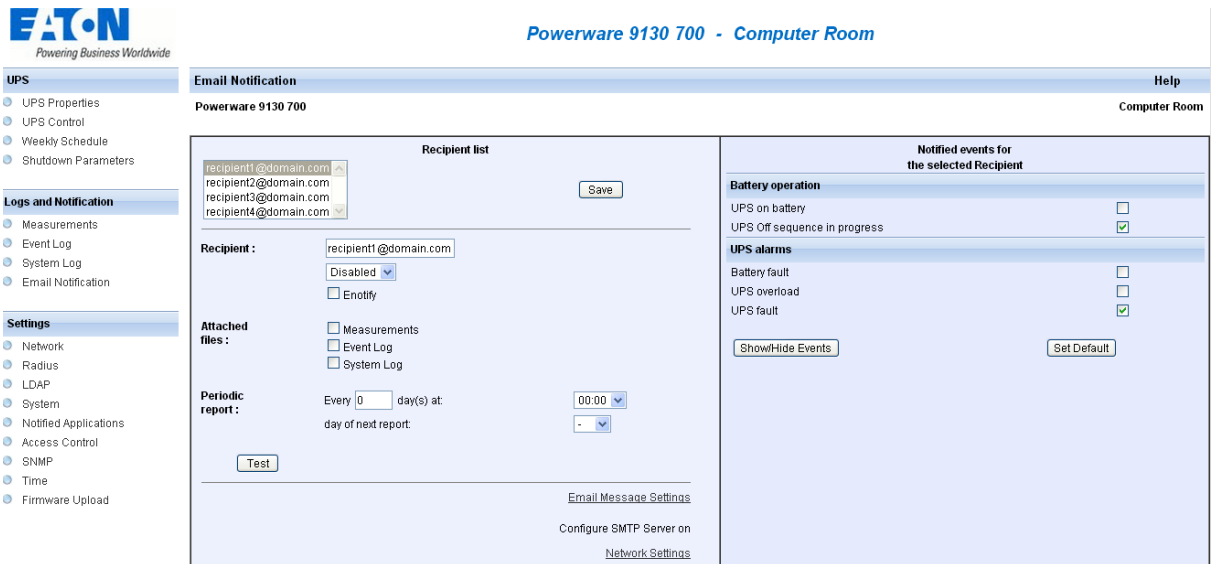

- **Recipient List:**

On the left side of this page, up to four recipients can be configured to receive e-mails from the card. Each addressee has its own trigger events, selected from the right side of the page, for which an e-mail is sent. The card's log indicates e-mail transmission errors.

Each recipient is configured with the following parameters:

- ⊗ **Recipient:** (Field is limited to 99 characters) this is the e-mail address of the person or department to receive the e-mail.
The default value is : recipientx@domain.com
- ⊗ **eNotify:** This parameter enables communications to the Eaton eNotify Monitoring and Diagnostics Service. NOTE: Available only for customers with a valid eNotify Service Contract.
- ⊗ **Attached files:** The files selected (Measurements, Event log, System log, Environment measurements) are enclosed with each e-mail sent. The files are sent in CSV format
- ⊗ **Periodic report:** In addition to the e-mails sent when events occur, a periodic e-mail containing the 3 log files (or 4 when the optional Sensor is connected) can be sent to the

Network Management Card (Network-MS) User Manual

recipient every x days at the time specified by the user.

To configure the first transmission, specify the day, time and frequency of the next transmission in the "next report" box. After this date, the page will show the date and time of the next transmission.

Data are sent in CSV format.

- **Save:** Saves any modifications.
- **Test:** enables an e-mail to be sent to the recipient immediately. This is one way of checking e-mail transmission, particularly access to the SMTP server configured in "Network" settings. A transmission report is added to the system log.
The event label in the subject and text of the message is replaced with a test label.
If the user makes any modifications to the page, they must be saved before using the "Test" function.
- **Notified events:**
The right side of the page shows the events that can be notified.
By default, only the main events of battery operation and a few UPS alarms are accessible. All the events appear if the Show/Hide Events option is actuated.
By default, two events are selected for notification. The user can modify this pre-selection by ticking other events or can, on the contrary, restore the initial configuration by clicking Set Default.
- **Email Message Settings:** access to the message configuration page
- **Network Settings:** enables the name of the SMTP server to be entered. [See page](#)

4.3.2 E-mail Message Settings

This page enables customisation of the content of the messages received by recipients of e-mails sent by the card.

Customisation is common to the four recipients that can be notified (see [E-mail notification](#)).

The screenshot shows the 'Email Message Settings' page for a Powerware 9130 700 UPS in a Computer Room. The interface includes a left sidebar with navigation menus for UPS, Logs and Notification, and Settings. The main content area is titled 'Email Message Settings' and contains the following fields and options:

- Sender:** A text input field containing 'ups@domain.com'.
- Subject:** A text input field containing 'Network Management Card - <Event message>'.
- Message text:** A large text area containing 'Type here your own text'.
- Options:** Three checkboxes are present: 'UPS Name' (unchecked), 'UPS Location' (unchecked), and 'Event message' (checked).
- Buttons:** A 'Save' button is located at the bottom of the form.

- Sender:** (59 characters maximum) identifies the source of the message. The default value is *ups@domain.com*.

This field is free. However, depending on the type of SMTP server configuration, it is possible that the server checks that the domain name contained in the Sender address exists, and even that the user in the Sender address belongs to this domain.
- Subject:** enables the user to specify the subject of the e-mail to be sent. By entering some free text and selecting from several optional fields, if desired, the message subject is built:

 - **UPS name** recalls the name of the UPS; it may or may not be selected.
 - **UPS location** recalls the geographic location of the UPS (see System Settings); it may or may not be selected.
 - **Event message** identifies the event generating the e-mail; it may or may not be selected.
- Message text** is a free zone long of 255 characters maximum.

The body of the e-mail sent is composed of:

 - Message text, which is free text.
 - The date and time of the event, as saved in the log.
 - URL of the card, enabling a direct link with the card to be established.
 - Attachments, as configured for the e-mail recipients.
 - Duplication of the subject, as configured.

Network Management Card (Network-MS) User Manual

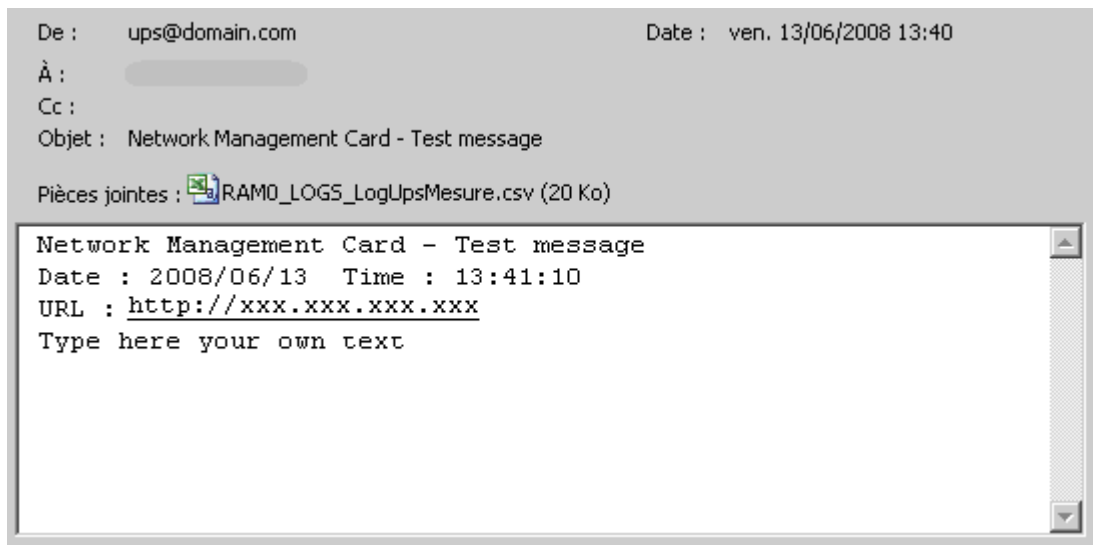

4.4 Configuration

4.4.1 Network settings

Click on **Network** in the menu.



NOTE If you are not already logged on, you will be prompted to enter your user name and password before accessing this page.

This menu enables the administrator to configure the network parameters of the card and authorisation of the remote upgrade of the embedded system.

EATON Powering Business Worldwide

Powerware 9130 700 - Computer Room

UPS Properties, UPS Control, Weekly Schedule, Shutdown Parameters

Logs and Notification: Measurements, Event Log, System Log, Email Notification

Settings: Network, Radius, LDAP, System, Notified Applications, Access Control, SNMP, Time, Firmware Upload

Network Settings Help

Powerware 9130 700 Computer Room

BootP/DHCP : Enabled

IP address : [x000.000.000.000]

Subnet Mask : [x000.000.000.000]

Gateway Address : [x000.000.000.000]

Hostname : ups36

Domain Name : ups.domain.com

IPv6 Enabled

IPv6 Auto Config Enabled

IPv6 Address 1 : [Waiting Router Advertisement...]

Prefix length : [0]

IPv6 Gateway : []

IPv6 Local Address : FE80::220:85FF:FEF5:7924

IPv6 Address 2 : [Waiting Router Advertisement...]

Firmware Upload : Enabled

Primary DNS Server (IPv4 or IPv6) : [x000.000.000.000]

Secondary DNS Server : [x000.000.000.000]

SMTP Server (for Email Notification) : []

SMTP port : [25]

SMTP server authentication

Login : smtplogin

Password : [*****]

Save modified settings : [Save]

- **BOOTP/DHCP:** Authorises (choose "Enabled") configuration of network parameters with your BootP/DHCP server when the card is booted.

Network Management Card (Network-MS) User Manual

Sequence with BootP/DHCP server: After each startup, the card makes 3 attempts to recover the network parameters. If no response is received from the server, the card boots with the last saved parameters from the previous start. These parameters are those shown on the page.

The default value for this parameter is "Enable"

Note 1:

If the hostname is not used, the IP address supplied by the DHCP server must be fixed to maintain connection with the clients installed on the stations to be protected.

Note 2:

During the first connection, if the DHCP query is not successful, the NMC starts with the following IP configuration:

Default IP address: 192.168.1.2

Subnet mask: 255.255.255.0

Gateway Address: 0.0.0.0

- **IP Address:** The IPv4 address of the card.
- **Subnet Mask:** The mask of the sub-network of your IPv4 network.
- **Gateway Address:** Indicate the IP address of the gateway to access the stations located outside the card's subnet.
- **Hostname** must be suited to the card. This is the first part of the fully qualified domain name, used by the DNS.
As the card does not support NetBIOS protocol, the hostname will only be sent to DNS if the DHCP server sends it the hostname with the new IP address. This mechanism is described in the update of the Dynamic DNS protocol [RFC 2136](#)
- **Domain Name** is the domain to which the card belongs. This is the part of the fully qualified domain name that follows the hostname and is used by the DNS. The default value of the two parameters comprising the fully qualified domain name: ups.domain.com
- **IPv6 Enabled:** Authorises (choose "Enabled") IPv6 support.
- **IPv6 Auto Config Enabled:** Authorises (choose "Enabled") the card to obtain configuration of IPv6 parameters from an IPv6 router. In this case, none IPv6 parameters are editable.
- **IPv6 Address 1:**
 - If Auto Config is enabled: this field displays the first IPv6 address built from the IPv6 router (not editable).
 - If Auto Config is not enabled: this field is editable and allows setting a static IPv6 address.
- **Prefix length:**
 - If Auto Config is enabled: this field displays the prefix received from router (not editable).
 - If Auto Config is not enabled: this field is editable and allows setting a prefix.
- **IPv6 Gateway:**
 - If Auto Config is enabled: this field is empty and not editable.
 - If Auto Config is not enabled, this field is editable and allows setting the default gateway.

Network Management Card (Network-MS) User Manual

- **IPv6 Local Address:** display the IP local address of the card, build from the MAC address. This field is not editable. Always available when the IPV6 is enabled.
- **IPv6 Address 2:**
 - If Auto Config is enabled: this field displays the second IPv6 address built from the IPv6 router (not editable).
 - If Auto Config is not enabled, this field is empty and not editable.
- **Firmware Upload:** Authorise (chose "Enabled") remote updating of the card's embedded software. The default value for this parameter is "Enabled".
- **Primary DNS Server:** contains the IPv4 or IPv6 address of the main DNS server ensuring conversion of the domain name to IP address.
- **Secondary DNS Server:** contains the IPv4 or IPv6 address of the secondary DNS server ensuring conversion of the domain name to IP address if the primary DNS server is not available.
- **SMTP Port:** contains the port number of the SMTP server.
- **SMTP Server:** contains the name or IP address of the local server with which the card connects to send e-mails.
It may be filled in either as host + domain name (DNS resolution), or directly with the IP address.
The default value is smtpserver. The card uses the standard port (25) for sending e-mails.
- **SMTP Server Authentication:** Displays **login** and **password** fields in order to connect the NMC card to a SMTP Server that requires an authentication.

Important note:

The card must be rebooted after any changes to these IP parameters. [See "System" page](#)

4.4.2 RADIUS

4.4.2.1 Setting Page Configuration

Click on **RADIUS** in the menu.



NOTE *If you are not already logged on, you will be prompted to enter your user name and password before accessing this page.*

This menu allows the administrator to configure RADIUS settings on the card. They are editable only if the parameter of the External Authentication on the [Access control](#) Access controlpage is set to RADIUS.

The screenshot shows the 'RADIUS Configuration' page for 'Evolution 650 - Computer Room'. The page includes a left-hand navigation menu with sections for 'UPS', 'Logs and Notification', and 'Settings'. The 'Settings' section is expanded to show 'Radius' selected. The main content area features a table with two columns for 'Evolution 650' and 'Computer Room'. The table lists two RADIUS servers: a PRIMARY server and a SECONDARY server, both with IP addresses 'xxx.xxx.xxx.xxx', authentication port '1812', a 'Time Out' of '10', and a 'Retry Number' of '3'. Below the table, there is a text prompt 'Select the Radius Server to be modified.' and a 'Modify Server' button.

	Evolution 650	Computer Room																				
	<table border="1"><thead><tr><th>Priority</th><th>Radius Server Name or IP Address</th><th>NAS IP Address</th><th>Auth. Port</th><th>Time Out</th><th>Retry Number</th></tr></thead><tbody><tr><td><input type="radio"/></td><td>PRIMARY</td><td>xxx.xxx.xxx.xxx</td><td>xxx.xxx.xxx.xxx</td><td>1812</td><td>10</td><td>3</td></tr><tr><td><input checked="" type="radio"/></td><td>SECONDARY</td><td>xxx.xxx.xxx.xxx</td><td>xxx.xxx.xxx.xxx</td><td>1812</td><td>10</td><td>3</td></tr></tbody></table>	Priority	Radius Server Name or IP Address	NAS IP Address	Auth. Port	Time Out	Retry Number	<input type="radio"/>	PRIMARY	xxx.xxx.xxx.xxx	xxx.xxx.xxx.xxx	1812	10	3	<input checked="" type="radio"/>	SECONDARY	xxx.xxx.xxx.xxx	xxx.xxx.xxx.xxx	1812	10	3	
Priority	Radius Server Name or IP Address	NAS IP Address	Auth. Port	Time Out	Retry Number																	
<input type="radio"/>	PRIMARY	xxx.xxx.xxx.xxx	xxx.xxx.xxx.xxx	1812	10	3																
<input checked="" type="radio"/>	SECONDARY	xxx.xxx.xxx.xxx	xxx.xxx.xxx.xxx	1812	10	3																

Two RADIUS servers can be registered. The secondary server is used when the primary does not respond in the delay (time out) and after the number of retry set.

The button "Modify Server" allows to edit and to modify the server configuration selected.

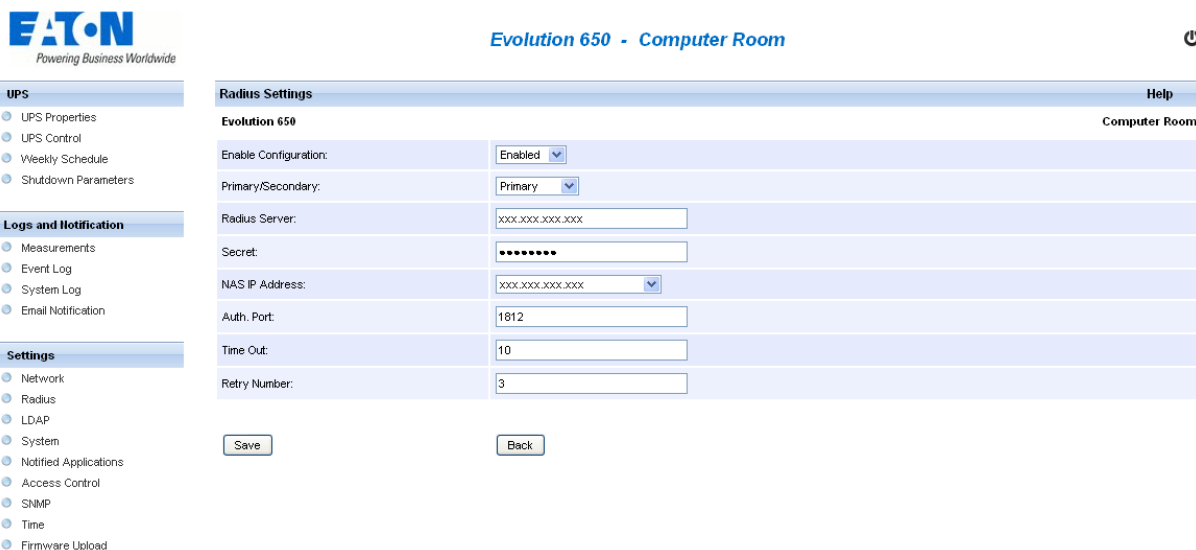

- **Enable Configuration:** If enabled, this server will be used during radius authentication process.
- **Primary/Secondary:** identifies the priority order between Radius servers. The primary is used in first (if enabled) , if it is unreachable, the secondary is used.
- **Radius Server:** identifies the name or the IP (IPv4 or IPv6) address of the server.
- **Secret:** identifies the secret shared between the card and the Radius Server
- **NAS IP Address:** identifies the IP address of the NAS (the Network Management Card) to use. The possible values in the GUI list are based on the IPv4 and IPv6(s) addresses of the card.
- **Auth. Port:** identifies the remote radius server port.
- **Time Out:** identifies the delay to wait before to send another radius request.
- **Retry Number:** identifies the number of request to send before testing another Radius server (if available).

4.4.2.2 Authorization management

After an authentication success, the card must check if the user has the permission to open a (admin) session.

Two radius attributes are used to manage admin authorization:

- An IETF attribute: Service-Type (6)
- An Eaton Vendor Specific Attribute (534): Eaton-UserLevel (28)

If one of these attribute is present with the value as defined in the following table the access of the card is allowed, else the access is **refused**:

Attribute Definition			Value for Admin Authorization
IETF Attribute Name	Attribut ID		
Service-Type	6		6
Vendor Specific Attribute Name	Vendor ID	Attribut ID	
Eaton-UserLevel	534	28	1

4.4.3 LDAP

4.4.3.1 Setting Page Configuration

Click on **LDAP** in the menu.



NOTE If you are not already logged on, you will be prompted to enter your user name and password before accessing this page.

This menu allows the administrator to configure LDAP settings on the card. The settings on this page are editable only if the parameter of the External Authentication on the [Access control](#) page is set to LDAP.

The screenshot shows the 'LDAP Configuration' page for 'Evolution 650 - Computer Room'. The page includes a left-hand navigation menu with sections for 'UPS', 'Logs and Notification', and 'Settings'. The 'Settings' section is expanded to show 'LDAP' as the selected option. The main configuration area contains the following fields:

- Authentication Mechanism: Single
- User Search Bind: By Accredited User
- Search User: CN=UPSAdminUser,CN=Users,DC=mbdevd,DC=ch,DC=etn
- Search User Password: [Redacted]
- User Base DN: CN=Users,DC=mbdevd,DC=ch,DC=etn,DC=com
- User Object: user
- User Attribute: sAMAccountName
- Authorization Mode: By Group
- UPS Group Base DN: OU=eUPSOU,DC=mbdevd,DC=ch,DC=etn,DC=com
- Group Name Attribute: sAMAccountName
- User Name Attribute: member

Below the configuration fields is a 'Set' button. At the bottom of the configuration area is a table of LDAP servers:

	Priority	LDAP Server Name or IP Address	Port
<input checked="" type="radio"/>	PRIMARY	xxx.xxx.xxx.xxx	389
<input type="radio"/>	SECONDARY		389

Below the table is a 'Select the LDAP Server to be modified.' label and a 'Modify Server' button.

- **Authentication Mechanism:** identifies the binding type used. The card supports simple and Digest MD5 (SASL) mechanisms. For Digest MD5, your DNS server **MUST** support the reverse lookup on the IP address of your LDAP server.
- **User Search Bind:** identifies the binding type used to search user. The card supports anonymous bind and a bind with an accredited user. When an accredited user is used, the Mechanism used is the Mechanism set in the Authentication Mechanism field.
- **Search User:** identifies the User which is used to search user information during login step. This attribute is a Distinguished Name when the Authentication Mechanism is set to simple, and a SASL username when the Authentication Mechanism is set to Digest MD5.
- **Search User Password:** identifies the password of the Search User.

Network Management Card (Network-MS)

User Manual

- **User Base DN:** identifies the database entry from which the user search is started.
- **User Object:** identifies the LDAP class of the user object.
- **User Attribute:** identifies the attribute name where the login identifier is stored.
- **Authorization Mode:** identifies the method to use for authorization:
 - None: all authenticated users are authorized.
 - By User Attribute: the authorization credential (UPSAdministrators value) is stored in the Group Name Attribute of the LDAP user.
 - By Group: the authorization credential is stored in LDAP Groups.
- **UPS Group Base DN:** identifies the database entry from which the UPS group search is started.
- **Group Name Attribute:** identifies the attribute name where the UPS group identifier ("UPSAdministrators" value) is stored.
- **User Name Attribute:** identifies the attribute name in the object group where the user identifier is stored.

Two LDAP servers can be registered. The secondary server is used when the primary does not respond in the delay (time out).

The button 'Modify Server' allows to edit and to modify the server configuration selected.

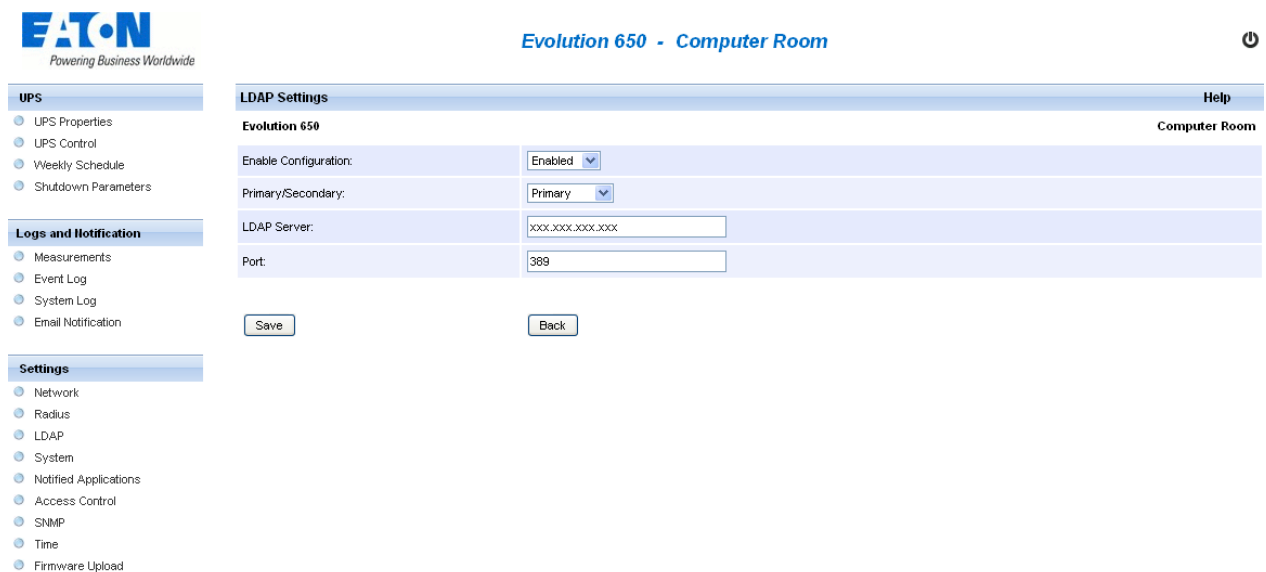

- **Enable Configuration:** If enabled, this server will be used during LDAP authentication process.
- **Primary/Secondary:** identifies the priority order between LDAP servers. The primary is used in first (if enabled) , if it is unreachable, the secondary is used.
- **LDAP Server:** Server Name or IP Address of the server.
- **Port:** identifies the remote LDAP server port.

4.4.3.2 Authorization management

When an authorization mode is set, the “**UPSAdministrators**” string is searched in the LDAP Directory. Consequently, the LDAP Directory must be updated in the following way to allow users to open Web session in the NCM card:

- If the mode is “**By User Attribute**”: the administrator must set the LDAP attribute defined by the “**Group Name Attribute**” with the “**UPSAdministrators**” value. This update must be done for all allowed users.
- If the mode is “**By Group**”: the LDAP administrator must create a group with the following properties :
 - The location of this group in the LDAP directory must set under the DN path set in the **UPS Group Base DN** value.
 - The attribute defined in the **Group Name Attribute** must be set with the “**UPSAdministrators**” value.
 - All allowed users must be declared as member of this group: the multi valued attribute defined in the **User Name Attribute** must be set with all allowed users DN .

4.4.3.3 MD5 Authentication Mechanism

When MD5 is set as Authentication Mechanism, the following rule must be applied:

- A DNS server must be registered in the Network Configuration of the card.
- A DNS reverse lookup must be possible for the LDAP IP server.
- If an Accredited User is used for the LDAP search, its name is no longer a DN but a SASL name.
- The user login must be compliant with the SASL name rules of the LDAP server used.

4.4.3.4 Typical Setting Values for Active Directory

If the LDAP server is Active Directory, the following values are usually employed:

For user settings :

- User Object: **user**
- User Attribute: **sAMAccountName**

For Authorization settings when the group mode is set:

- Group Name Attribute: **sAMAccountName**
- User Name Attribute: **member**

4.4.4 System

Click on **System** in the menu.



NOTE *If you are not already logged on, you will be prompted to enter your user name and password before accessing this page.*

This menu enables the customisation of the information on the [UPS properties](#) pages.

- **UPS Contact:** This text field is limited to 49 characters. Enter the name of the person responsible for UPS administration at IT network level and/or electrical maintenance. This field does not appear on any other Web page. By default, its value is "Computer Room Manager".
- **UPS Location:** Enter a description (limited to 31 characters) of the location of the UPS in your installation (e.g. Computer room E1-C066). This text is displayed in the home page and in the title of the page. By default, its value is "Computer Room".
- **Default Language:** Enables initialisation of the browser language at card connection. Choice of one of the available languages: English, French, German, Spanish, Italian, Chinese Traditional, Chinese simplified, Japanese, Portuguese, Russian, Korean, Czech changes the language of the html interface pages (Refresh the web page <F5> after modification).
- **History log interval:** [from 5 to 99999 sec., 60 by default]. Measurement save period.
- **Environment log interval:** [from 60 to 99999 sec., 300 by default]. Temperature and humidity measurement save period.
- **Reset Communication button:** performs a remote reboot of the card without modifying the configuration. This action is compulsory for consideration of any changes made on the "Network Settings" page.
- **Factory Reset button:** enables restoration of the default configuration of all the card's parameters. TCP/IP parameters: IP address, subnet mask, gateway and BootP/DHCP value are maintained if the "Keep TCP/IP parameters" option is selected.

4.4.5 Notified Applications

Click on **Notified Applications** in the menu.



NOTE *If you are not already logged on, you will be prompted to enter your user name and password before accessing this page.*

This menu enables:

- The addition of the supervision stations receiving traps and configuration of the trap type.
- To list all the Notified Applications and the main parameters.
- To test the operation of notified applications by simulating power loss by sending a real shutdown sequence.

Up to 100 destinations can be managed by the card:

- 35 in TCP connected mode or
- 100 in UDP not connected mode or
- mixed mode: 20 connected and 50 not connected.

Important note: It is not necessary to add the Intelligent Power Protector protecting your servers in this list. These modules subscribe and unsubscribe themselves automatically.

Select an entry in the list to modify the values in the edit zone at the bottom of the page. The table displays the following information:

- **All:** selects all the lines.
- **Nr:** the index where the application is stored into the table.
- **Hostname or Address IP:** By priority, the hostname of the computer is displayed when the IP address can be converted into a hostname by a DNS server or if the application has been entered as a hostname.

Network Management Card (Network-MS) User Manual

- **Application Name:** Given by the application at subscription time.
- **Output:** number of the UPS output from which the client is powered.
- **Configuration:** shows where the parameters of the Intelligent Power Protector come from: Local (coming from the application) or Central (coming from the card).
The [Central shutdown configuration](#) is available by clicking on the **Configuration** link.
- **Shutdown duration:** the shutdown duration necessary to properly shutdown the computer.
- **Shutdown after:** the time available to the user from the power failure until the launch of the shutoff sequence of the UPS and equipment.
- **Connected:** This value is set to YES if the notified application connects through TCP protocol.

Many actions are available on this page:

- **Remove:** Depending on the kind of application, the selected ones will definitively disappear from the table as SNMP applications, or they will disappear and automatically re-subscribe as Intelligent Power Protector applications.
- **Utility failure Test:** Two alarms, 'Utility failure' and 'Utility restored' spaced 60 seconds apart, will be sent to the applications selected, making sure that the applications can be reached over the network.
- **Shutdown Test:** This test simulates a UPS low battery sequence. It enables an easy check to see if the server protection works correctly.
 - No intervention on the UPS is required.
 - The applications selected will process the simultaneous alarms and perform an actual shutdown sequence.

WARNING!

- This test will generate a REAL shutdown sequence of the selected servers on which the Intelligent Power Protector application is running.

- **Add NMS:** allows an SNMP trap receiver to be added such as a Network Management System.
- **Modify NMS:** allows an SNMP trap receiver to be modified.

Both buttons open a new window where it is possible to enter the Application name, the Hostname or IP Address, the trap port, the protocol version needed: V1, V3 or both, the Trap community (only used in V1) and the filter on the several implemented MIBs.

Network Management Card (Network-MS)

User Manual



Powerware 9130 700 - Computer Room

UPS	Network Management System
<ul style="list-style-type: none">UPS PropertiesUPS ControlWeekly ScheduleShutdown Parameters	Powerware 9130 700 Computer Room
Logs and Notification	Application Name : <input type="text"/>
<ul style="list-style-type: none">MeasurementsEvent LogSystem LogEmail Notification	Hostname or IP address : <input type="text"/>
Settings	<input type="checkbox"/> Trap Port : <input type="text" value="162"/>
<ul style="list-style-type: none">NetworkRadiusLDAPSystemNotified ApplicationsAccess ControlSNMPTimeFirmware Upload	Protocol : <input type="text" value="V1&V3"/>
	Trap Community : <input type="text"/>
	MIB filter: <input type="checkbox"/> Pulsar
	<input type="checkbox"/> IETF
	<input checked="" type="checkbox"/> Powerware
	<input type="button" value="Cancel"/> <input type="button" value="Save"/>

By default, the MIB filter selected corresponds to UPS: Pulsar or Powerware.

4.4.6 Central shutdown configuration

Note: Intelligent Power® Manager provides more advanced configuration management features. Click on Notified Applications in the menu, then Configuration.

The screenshot shows the configuration interface for a Powerware 9130 700 UPS in a Computer Room. The left sidebar contains navigation menus for UPS, Logs and Notification, and Settings. The main content area is titled 'Central shutdown configuration' and includes a 'Help' link. Below the title, it identifies the device as 'Powerware 9130 700' and notes that this configuration will be used by the shutdown application on the next connection. The 'Shutdown Parameters' section contains a checkbox for 'Shutdown after:' with a value of 30 minutes, and a 'Shutdown duration:' field set to 120 seconds. The 'Broadcast' section has checkboxes for 'Administrators' and 'Users', both of which are checked. A 'Save' button is located at the bottom of the configuration area.

This page is used to define either the "shutdown" or the "notification" settings used by the Intelligent Power Protector that connects to Network Management Card. These settings are used by the Intelligent Power Protector if they are in central-configuration mode or if their configuration is not valid.

- **Shutdown duration:** the shutdown duration necessary to properly shutdown the computer.
- **Shutdown after:** the time available to the user from the power failure until the launch of the shutoff sequence of the UPS and equipment. This parameter is optional. Uncheck the box if you wish not to use this parameter.
- **Broadcast :** Sends network notifications to the **Administrators** and **Users** groups on events declared in the server hosting the NSM

If you wish to set up a new configuration for the Network Shutdown Modules already set to "central-configuration mode", proceed as follows:

- Change the IPP parameters in the "Notified Applications" page.
- Click the "Save" button.
- In this page, select the IPPs for which you want to apply the new configuration.
- Press the "Remove" button.
- The IPPs selected will disconnect then reconnect and use the new configuration.

4.4.7 Access control

Click on **Access Control** in the menu.



NOTE *If you are not already logged on, you will be prompted to enter your user name and password before accessing this page.*

This menu enables configuration of the different parameters enabling secure access to the card via a browser.

- **Enter New Manager Login:** The login user name. This text field (limited to ten characters) enables secure access and modification of pages. Default value is admin.
- **Enter New Password:** This text field (limited to ten characters) enables secure access to Configuration menu pages. Default value is **admin**.
- **Confirm New Password:** Re-enter the new password.
- **External Authentication:** identifies the type of authentication used between LDAP and Radius. If None is chosen, the local user database is used.
- **Authentication Order:** identifies the priority order used between local and external authentication.
- **Session Time expiration after inactivity (s):** identifies the time after which the session is closed if no activity is detected.
- **Maximum Session Time (s):** identifies the maximum time of a session whatever activity.
- **Security mode:** Manages the various authentication methods for page access:
 - Authentication for configuration:** Only the configuration pages are protected by login / password
 - Full authentication:** All pages are protected by login / password
 - SSL and full authentication:** All pages are protected by login / password and are only accessible in SSL

SSL Access: When selected, access to the Web interface is made in secure mode (https).

Network Management Card (Network-MS) User Manual

Connections with Intelligent Power Protector stay in standard mode (secure TCP)

SSL Security Implementation:

SSL	→ version 3.0
TLS	→ version 1.0
Method	→ TLS_RSA_WITH_512_MD5
Certificate	→ 1024 bits
Auth	→ RSA
Key Exchange	→ RSA
Encryption	→ RC4_512
Digest	→ MD5

Changes take effect after a card reboot

- **Telnet access:** This parameter enables the access to the setting parameters interface via a Telnet/SSH connection.
- **Telnet security:** This parameter defines the protocol for the access to the setting parameters interface. These 2 values are mutually exclusive.
- **TELNET:** The data are read or written via an unsecured access.
- **SSH:** The data are read or written via a secured access.
- **Console interface:** This parameter defines the way to access the setting parameters. The 2 values are mutually exclusive. The selected HMI (Human Machine Interface?) is available for the TCP/IP connection (RS232 not concerned) and for the 2 protocols (Telnet, SSH). The new value will be taken into account after a manual reset of the NMC.
- **MENU:** The HMI is a menu interface and the parameters are accessible via some pre-defined menus.
- **CLI:** The access to the parameters is done independently of each other using the command line interface.
- **Save:** Saves any modifications.

4.4.8 SNMP Setting

Click on **SNMP** in the menu.

To access this page, the login and password are systematically requested if they have not already been entered. This menu enables configuration of the SNMP security parameters.

The screenshot shows the 'SNMP Settings' page for a Powerware 9130 700 UPS in a Computer Room. The page is divided into several sections:

- UPS Settings:** Includes links for UPS Properties, UPS Control, Weekly Schedule, and Shutdown Parameters.
- Logs and Notification:** Includes links for Measurements, Event Log, System Log, and Email Notification.
- Settings:** Includes links for Network, Radius, LDAP, System, Notified Applications, Access Control, SNMP, Time, and Firmware Upload.
- SNMP Settings:**
 - Powerware 9130 700:**
 - SNMP Version: V1 & V3 (dropdown)
 - SNMP Port: 161 (input field)
 - SNMP V1 Setting:**
 - Community Read-Only: public (input field)
 - SNMP Write: Enabled (dropdown)
 - Community Write: private (input field)
 - SNMP V3 Setting:**
 - Read-Only User: readuser (input field)
 - Read-Only Security Level: Auth No Priv (dropdown)
 - Read-Only Password: [masked] (input field)
 - Read-Write User: writeuser (input field)
 - Read-Write Security Level: Auth Priv (dropdown)
 - Read-Write Password: [masked] (input field)
 - Notification Username: notifuser (input field)
- Save modified settings:** A 'Save' button is located at the bottom of the settings section.

- **SNMP Version:** This field allows the user to select the snmp protocol version: {Disabled, V1, V3 are supported by the card}.
- **SNMP Port:** Allows the user to select and modify the port number of the SNMP server.
- **SNMP Community Read-Only:** The SNMPv1 Read community name that identifies a sub-group attached to a network manager or a logical entity. The card and the clients must share the same community name to communicate.
- **SNMP Write Enabled:** Enables SNMP write function.
SNMP Community Write: Displays only if SNMP Write is enabled. The SNMPv1 Write community name that identifies a sub-group attached to a network manager or a logical entity. The card and the clients must share the same community name to communicate.
- **Read-Only User:** identifies the login of the user in the SNMPv3 version which is authorized to read only SNMP variables.
- **The Read-Only Security Level:** selects the security level
 - No Auth No Priv: the user must not use authentication and privacy to access to SNMP variables.
 - Auth No Priv: the user must use authentication and NOT privacy to access to SNMP variables.
 - Auth Priv: the user must use authentication and privacy to access to SNMP variables.

Network Management Card (Network-MS) User Manual

- **The Read-Only Password:** allows administrator to specify a new password for the Read-Only User. Its length must be ranging between 8 and 24 characters and used only letters, numbers and <>&@#%_=:;,./?|\$*() symbols.
- **The Read-Write User:** identifies the user in the SNMPv3 version which is authorized to read and write SNMP variables.
- **The Read-Write Security Level:** selects the security level:
 - No Auth No Priv: the user must not use authentication and privacy to access to SNMP variables.
 - Auth No Priv: the user must use authentication and NOT privacy to access to SNMP variables.
 - Auth Priv: the user must use authentication and privacy to access to SNMP variables.
- **The Read-Write Password:** allows administrator to specify a new password for the Read-Write User. Its length must be ranging between 8 and 24 characters and used only letters, numbers and <>&@#%_=:;,./?|\$*() symbols.
- **The Notification username:** allows administrator to specify the “username” field for SNMPV3 notifications. This field has to also be defined in the applications that received those notifications.
- **Save:** Saves any modifications.

4.4.9 Date and time

Click on **Date and Time** in the menu.

This menu enables initialisation of the date and time of the card in three different ways.

The date format is always of year/month/day type

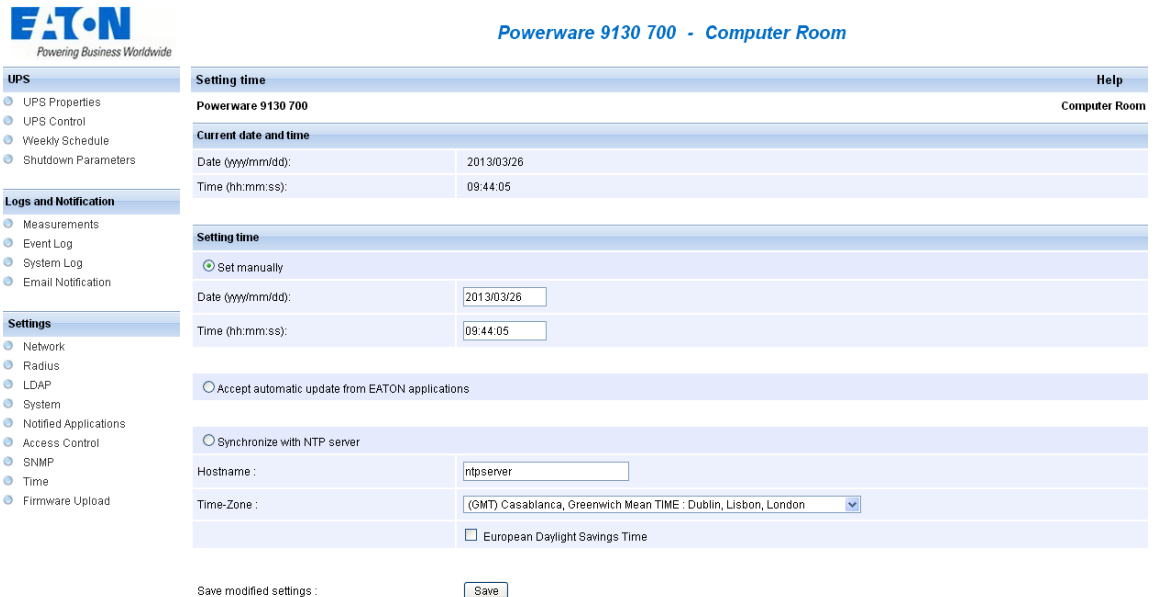

- **Set manually:** Enables initialisation of the date and time of the card, with the values entered in the Date and Time fields. This update is made after clicking on the **Save** button.

Maximum drift is +/- 2 min./month
- **Accept automatic update from IPP or IPM:** Enables initialisation of the date and time of the card, with the values provide by the Intelligent Power Protector or the Intelligent Power Manager.
- **Synchronize with NTP server:** Enables connection with a time server, either available on the company's internal network or on the Web. This server communicates GMT time. The IP address or hostname of the time server must be entered, and the time zone of your geographic area must then be selected from the list. Connection is made with the server and the date and time are set after clicking on the "Save" button. Time is updated every five hours, thus preventing any drift in the time. After two attempts, if the NTP server is not accessible, the card resends periodic requests.

The card uses the NTP protocol (UDP 123 port). The "firewall" must be configured to transmit queries outside the intranet. When ntp could not be contacted, an error message is issued at the top of the web page.

Note 1:

The even the card is used in a UPS supporting time-stamping, the card's time is automatically synchronized with that of the UPS.

Note 2:

After start-up, if the card is in manual mode or if no NTP server was reached, the card initializes at 01/01/1970.

4.4.10 Firmware upload

Click on **Firmware Upload** in the menu.

This menu enables a new firmware version to be uploaded

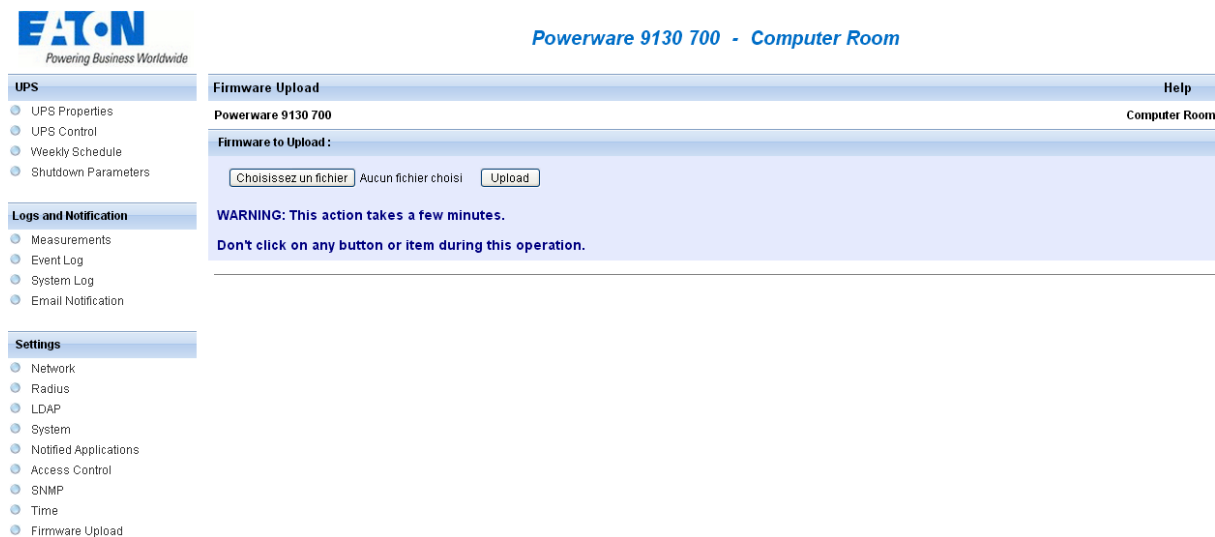

To upload a new version of the card's firmware, select the file to be loaded using the **Browse...** button and click **Upload**.

Do not interrupt the operation before the card displays the following screen:

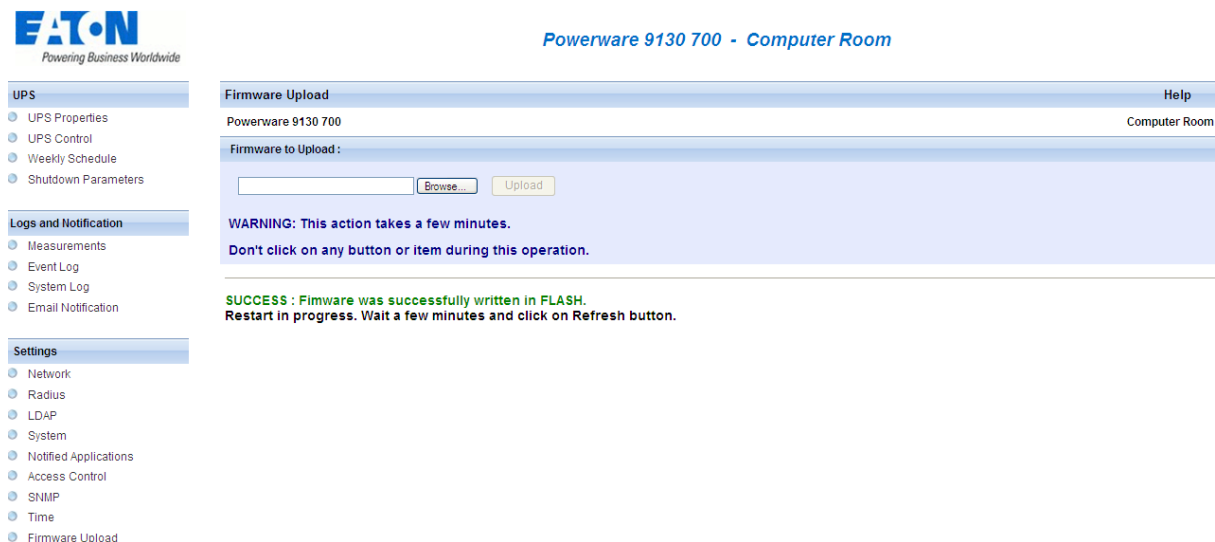

4.5 Environment Sensor (option)

The environment sensor (66846) is an option that enables temperature and humidity to be measured, and indication of the position of two external contacts. It is connected with a standard network cable to the Card Settings port of the Network Management Card.

The card automatically detects sensor presence. The main menu then displays an additional section "Environment" with the following elements:

- Status
- Configuration
- Log

Important note: To switch the serial port to the configuration mode, just disconnect the cable and [reset the card](#).

4.5.1 Characteristics

- Temperature measurement from 0 to 70 °C with +/- 1°C accuracy
- Measurement of humidity from 0 to 100% with +/- 6% accuracy
- Min / max time-stamped function for temperature and humidity
- Choice of temperature readings in Celsius or Fahrenheit
- High and low thresholds, hysteresis and offset adjustable via Web interface
- Possibility of notification of status changes by e-mail, SMS or SNMP trap
Note: SMS notification requires the use of a third-party application that converts emails to SMS
- Position detection of 2 dry contacts (maximum sensor/contact distance: 20 m)
- Name and status of each configurable contact
- Recording of events and measurements in the card log
- Possibility of shutting down the installation safely if one of the thresholds is exceeded or dry contact status change
- Connection to the Network Management Card by shielded CAT5 straight RJ45 network cables (maximum card/sensor distance: 10m)

4.5.2 Environment Status

EATON
Powering Business Worldwide

Powerware 9130 700 - Computer Room

Environment Status Help

Powerware 9130 700 Computer Room

Temperature

0 **25.3 °C** 70

Min: 19.0 recorded on 2013/02/25 07:50:02
Max: 26.1 recorded on 2013/02/15 17:48:07

Configure thresholds on [Environment Settings](#)

Humidity

0 % **25.6 %** 100 %

Min: 15.0 % recorded on 2013/02/24 06:50:27
Max: 28.8 % recorded on 2013/03/07 10:11:49

Configure thresholds on [Environment Settings](#)

Input #1

1970/01/01 00:00:00 Input #1 open

Input #2

1970/01/01 00:00:00 Input #2 open

UPS

- UPS Properties
- UPS Control
- Weekly Schedule
- Shutdown Parameters

Logs and Notification

- Measurements
- Event Log
- System Log
- Email Notification

Settings

- Network
- Radius
- LDAP
- System
- Notified Applications
- Access Control
- SNMP
- Time
- Firmware Upload

Environment

- Status
- Settings
- Log

For both measurements, a graduated gauge proposes the following functions:

The cursor indicates the current value.

Two red zones to the left and right represent the high and low thresholds that can be set on the Environment Settings page.

When the measured value enters one of these zones, an alarm can be notified (see Notification parameter in the Environment Settings page).

Time-stamped minimum and maximum temperatures show the extreme values recorded since the last Reset Min/Max.

Min and Max can be forced at any time to the current value by clicking on the Reset Min/Max button.

Calibrate: The sensor is factory-calibrated, but the user can apply an offset to adjust the measurement.

Input #1 and Input #2 show the position of the two contacts acquired by the sensor.

The position is displayed with the parameters entered in the Environment Settings page.

The last status change of each contact is time-stamped.

The Internet browser updates this page every 10 seconds

4.5.3 Environment Settings



NOTE If you are not already logged on, you will be prompted to enter your user name and password before accessing this page.

Powerware 9130 700 - Computer Room

UPS	Environment Settings	Help																																													
<ul style="list-style-type: none"> ● UPS Properties ● UPS Control ● Weekly Schedule ● Shutdown Parameters 	<p>Powerware 9130 700 Computer Room</p> <table border="1" style="width: 100%; border-collapse: collapse;"> <thead> <tr> <th style="width: 30%;">Sensor name:</th> <th style="width: 40%;">Environment sensor</th> <th style="width: 15%;">Notification</th> <th style="width: 15%;">System Shutdown</th> </tr> </thead> <tbody> <tr> <td rowspan="3">Temperature</td> <td>High threshold: <input type="text" value="40"/></td> <td><input type="checkbox"/></td> <td><input type="checkbox"/></td> </tr> <tr> <td> <div style="display: flex; align-items: center;"> <div style="border: 1px solid #ccc; padding: 2px; margin-right: 5px;">°C</div> <div style="flex-grow: 1;"> Low threshold: <input type="text" value="5"/> </div> </div> </td> <td><input type="checkbox"/></td> <td><input type="checkbox"/></td> </tr> <tr> <td>Hysteresis: <input type="text" value="2"/></td> <td></td> <td></td> </tr> <tr> <td rowspan="3">Humidity</td> <td>High threshold: <input type="text" value="90"/> %</td> <td><input type="checkbox"/></td> <td><input type="checkbox"/></td> </tr> <tr> <td>Low threshold: <input type="text" value="5"/> %</td> <td><input type="checkbox"/></td> <td><input type="checkbox"/></td> </tr> <tr> <td>Hysteresis: <input type="text" value="5"/> %</td> <td></td> <td></td> </tr> <tr> <td rowspan="4">Settings</td> <td>Input #1:</td> <td><input type="text" value="Input #1"/></td> <td><input type="text" value="closed"/> when closed</td> <td><input type="checkbox"/></td> <td><input type="checkbox"/></td> </tr> <tr> <td></td> <td></td> <td><input type="text" value="open"/> when open</td> <td><input type="checkbox"/></td> <td><input type="checkbox"/></td> </tr> <tr> <td>Input #2:</td> <td><input type="text" value="Input #2"/></td> <td><input type="text" value="closed"/> when closed</td> <td><input type="checkbox"/></td> <td><input type="checkbox"/></td> </tr> <tr> <td></td> <td></td> <td><input type="text" value="open"/> when open</td> <td><input type="checkbox"/></td> <td><input type="checkbox"/></td> </tr> </tbody> </table> <p style="text-align: center;"><input checked="" type="checkbox"/> Show advanced parameters</p> <p>Save modified settings : <input type="button" value="Save"/></p>	Sensor name:	Environment sensor	Notification	System Shutdown	Temperature	High threshold: <input type="text" value="40"/>	<input type="checkbox"/>	<input type="checkbox"/>	<div style="display: flex; align-items: center;"> <div style="border: 1px solid #ccc; padding: 2px; margin-right: 5px;">°C</div> <div style="flex-grow: 1;"> Low threshold: <input type="text" value="5"/> </div> </div>	<input type="checkbox"/>	<input type="checkbox"/>	Hysteresis: <input type="text" value="2"/>			Humidity	High threshold: <input type="text" value="90"/> %	<input type="checkbox"/>	<input type="checkbox"/>	Low threshold: <input type="text" value="5"/> %	<input type="checkbox"/>	<input type="checkbox"/>	Hysteresis: <input type="text" value="5"/> %			Settings	Input #1:	<input type="text" value="Input #1"/>	<input type="text" value="closed"/> when closed	<input type="checkbox"/>	<input type="checkbox"/>			<input type="text" value="open"/> when open	<input type="checkbox"/>	<input type="checkbox"/>	Input #2:	<input type="text" value="Input #2"/>	<input type="text" value="closed"/> when closed	<input type="checkbox"/>	<input type="checkbox"/>			<input type="text" value="open"/> when open	<input type="checkbox"/>	<input type="checkbox"/>	
Sensor name:	Environment sensor	Notification	System Shutdown																																												
Temperature	High threshold: <input type="text" value="40"/>	<input type="checkbox"/>	<input type="checkbox"/>																																												
	<div style="display: flex; align-items: center;"> <div style="border: 1px solid #ccc; padding: 2px; margin-right: 5px;">°C</div> <div style="flex-grow: 1;"> Low threshold: <input type="text" value="5"/> </div> </div>	<input type="checkbox"/>	<input type="checkbox"/>																																												
	Hysteresis: <input type="text" value="2"/>																																														
Humidity	High threshold: <input type="text" value="90"/> %	<input type="checkbox"/>	<input type="checkbox"/>																																												
	Low threshold: <input type="text" value="5"/> %	<input type="checkbox"/>	<input type="checkbox"/>																																												
	Hysteresis: <input type="text" value="5"/> %																																														
Settings	Input #1:	<input type="text" value="Input #1"/>	<input type="text" value="closed"/> when closed	<input type="checkbox"/>	<input type="checkbox"/>																																										
			<input type="text" value="open"/> when open	<input type="checkbox"/>	<input type="checkbox"/>																																										
	Input #2:	<input type="text" value="Input #2"/>	<input type="text" value="closed"/> when closed	<input type="checkbox"/>	<input type="checkbox"/>																																										
			<input type="text" value="open"/> when open	<input type="checkbox"/>	<input type="checkbox"/>																																										
<ul style="list-style-type: none"> ● Status ● Settings ● Log 																																															

The environment sensor measures temperature, humidity and gives the status of the 2 contacts (used for door, alarms or generator unit).

The temperature and humidity thresholds can be adjusted and can trigger notification and correct shutdown of the protected system.

The Sensor name is the function name given to the sensor, usually it enables location of the sensor.

Temperature: Choose the temperature unit (°C or °F) from the selection box.

Note: Changing the temperature unit clear the log file.

High threshold: if this value is exceeded, a notification if enabled. The default value is 40 °C / 104 °F.

Low threshold: If this value is exceeded, a notification if enabled. The default value is 5 °C / 41 °F.

Hysteresis must be set to prevent multiple notifications if temperature fluctuates around a threshold.

The default value is 2 °C / -3.6 °F.

The high alarm disappears when the value drops below the High threshold - Hysteresis value

The low alarm disappears when the value returns above the Low threshold + Hysteresis value

Humidity

High threshold: If this value is exceeded, a notification is sent if this is validated. The default value is 90%.

Low threshold: If this value is exceeded, a notification is sent if this is validated. The default value is 5%.

Hysteresis must be set to prevent multiple notifications if humidity fluctuates around a threshold. The default value is 5%.

Network Management Card (Network-MS) User Manual

The high alarm disappears when the value drops below the High threshold - Hysteresis value

The low alarm disappears when the value returns above the Low threshold + Hysteresis value

Input #1 and **Input #2**: Enter an identifier corresponding to the acquired contact (e.g.: rack door, air conditioning, generator unit, etc.). Max. length is 28 characters.

When closed and when open: are the names associated to the two contact positions. (e.g.: "open" and "closed" for a door, "On" and "Off" for a generator).

Each status change triggers a notification if enabled.

When the **Notification** box is enabled, the following functions are activated for each event selected:

- display in the [list of current alarms](#)
- Consideration in the [UPS log](#)
- SNMP trap generation
- notification by e-mail (if the Environment sensor notification option is enabled in the [e-mail notification](#) page)

The list of messages is provided in the [appendix](#)

System shutdown can be triggered for each notification if this option is enabled. If notification is disabled, the Shutdown option cannot be used.

4.5.4 Log

EATON
Powering Business Worldwide

Powerware 9130 700 - Computer Room

Environment Log Data Help

Powerware 9130 700 Computer Room

Date	Time	Temperature (°C)	Humidity (%)
2013/03/06	09:32:11	23	24
2013/03/06	09:37:19	23	24
2013/03/06	09:42:27	23	24
2013/03/06	09:47:35	23	24
2013/03/06	09:52:43	23	24
2013/03/06	09:57:51	23	24
2013/03/06	10:02:59	23	24
2013/03/06	10:08:07	23	24
2013/03/06	10:13:15	23	24
2013/03/06	10:18:23	23	24
2013/03/06	10:23:31	23	24
2013/03/06	10:28:39	23	24
2013/03/06	10:33:47	23	24
2013/03/06	10:38:55	23	24
2013/03/06	10:44:03	23	24
2013/03/06	10:49:12	23	24
2013/03/06	10:54:20	23	24
2013/03/06	10:59:28	23	24

The two environment sensor measurements: Temperature and Humidity are recorded at an interval defined by the Environment log interval in the [System settings](#) page.

By default, this period is 300 seconds.

Each measurement is dated and stored in the log of the UPS's communication card.

The size of log files is limited by a time indexing system.

The user can **Save** the log on his/her workstation at any time, in a CSV format file.

The user can also **Clear** the files contained in the card to reset the log.

5 Server protection

5.1 Set-up of the shutdown parameters

The protection application: Intelligent Power Protector, on protected server boot, subscribes itself automatically to [notified applications](#) list and sends its essential data:

- IP Address or hostname of the server on which it is installed: So that the card can inform it of power events.
- Time required to shutdown the server (Shutdown Duration, configurable in the "Set-up" menu of each IPP): The card takes into account the longest shutdown time of all the Intelligent Power Protector subscribed (This is the Shutdown duration of the [Shutdown parameters](#)) page to manage UPS shutdowns without affecting any of IPP connected.

During normal operation, the protection application periodically checks its connection with the card.

In case of a major power event, the card sends information to the protection application which reacts according to the situation. (shutdown order, programmed actions, messages to the administrator and to users via the network)

When the server shuts down, the protection application unsubscribes itself from the [notified applications](#).

5.1.1 Shutdown criteria managed by the Network Management Card

During an extended power failure, three criteria may cause the server shutdown procedure to be initiated. If several criteria are selected, (See page [Shutdown parameters](#)), the first criterion encountered will launch the shutdown procedure.

At the end of the shutdown procedure, when all servers have been shut down, the UPS may shut down to avoid unnecessary discharge of its batteries, depending on its configuration.

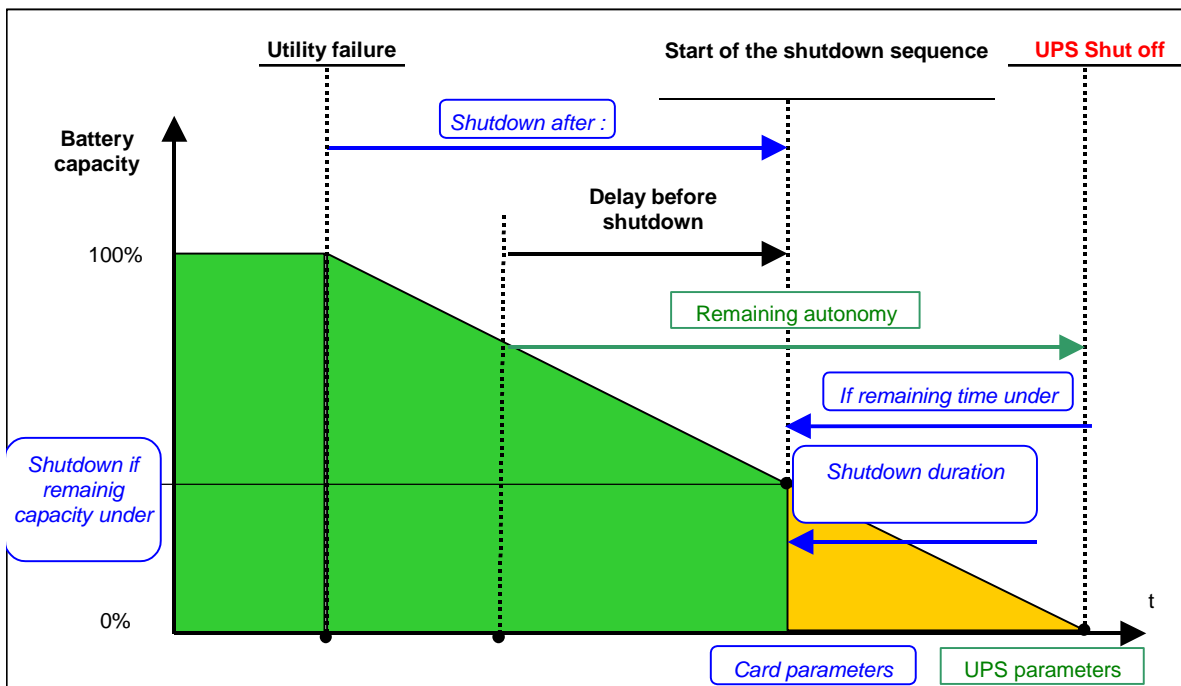

5.1.1.1 Backup time before initiating the shutdown procedure (Shutdown After – Shutdown Timer)

When the UPS switches to battery, the Network Management Card starts the Shutdown Timer countdown and launches the system shutdown procedure at the end of the countdown. This value must be chosen so that users have time to complete their tasks and disconnect, without exceeding battery backup time.

Note 1:

The Intelligent Power Protector can also manage its own Shutdown Timer (configurable in the Shutdown Module "set-up" menu of each Intelligent Power Protector) launched when the UPS switches to battery. Note that if this criterion is selected to initiate system shutdown, automatic system reboot when power is restored is not guaranteed (e.g. power restoration if only this system was shut down).

5.1.1.2 Initiating the shutdown procedure when the battery level is lower than: (If Capacity under)

When the card detects that the remaining backup time percentage is less than the configured level, the shutdown sequence is started. By default, this value is set at 20%.

Note:

The UPS already manages an equivalent parameter for the end of backup pre-alarm.

Network Management Card (Network-MS) User Manual

The card does not accept values less than that programmed in the UPS.
Check the UPS documentation.

5.1.1.3 Shutdown when backup time is less than

When the Network Management Card detects that the percentage of backup time remaining is less than the value set, the shutdown sequence is started.

5.1.1.4 Shutdown duration

Duration (in seconds) required for the system protected by the protection application to shut down.

The protection applications send their own "Shutdown duration" to the Network Management Card.
Based on these values (maximum Shutdown duration of all subscribed customer systems) that the card will send to the delayed shutdown order to the UPS.

5.1.2 Controlled outlets

Certain UPS models are equipped with controlled outlets (generally 2) which are always dependant on the UPS's main outlet.

Shutdown of the main outlet systematically causes shutdown of the programmable outlets.

Warning: Some inverters have only 2 programmable plugs without mains plug (Powerware). With this type of UPS, stopping a programmable outlet causes the UPS shutdown.

The following notations are used to identify these outlets:

- Main outlet: Main
- Controlled outlet 1 1
- Controlled outlet 2 2

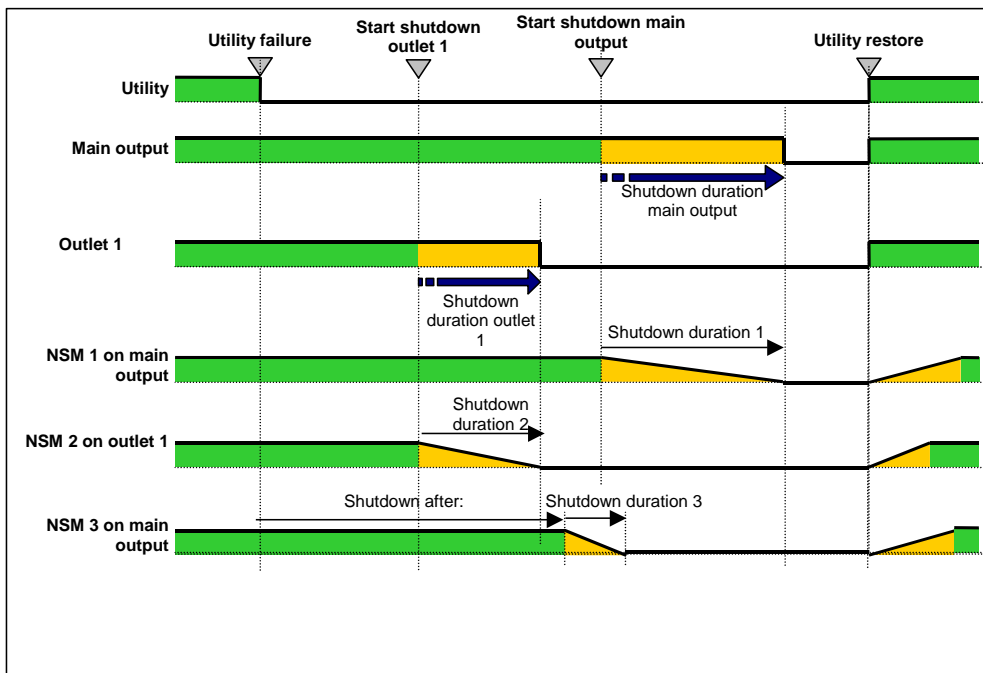

5.1.3 Protection of a server connected to a controlled outlet

Intelligent Power Protector (IPP) starting with version 3.0 are compatible with the controlled outlets.

After connecting the server electrically to one of the controlled outlets, the IPP must be informed of the outlet number to which it is connected.

Refer to the documentation of the IPP available on the internet site www.eaton.com

5.1.3.1 Load shedding or sequential shutdown

It is possible to optimise backup time by shutting down non-priority equipment or sequencing the shutdown of several devices.

Network Management Card (Network-MS) User Manual

Two shutdown criteria are possible:

- Shutdown of outlets after a set battery back-up time (After)
- Shutdown of outlets at a given battery discharge level (if battery capacity under)

It is possible to specify values for both criteria. The first criterion reached will initiate server shutdown.

5.1.3.2 Sequential startup

It is possible to delay outlet power-on to reduce inrush currents on startup or to sequence the startup of several devices.

Controlled outlet startup after a given time is based on startup of the main outlet.

5.2 The different server and UPS shutdown sequences

5.2.1 Extended power outage, shutdown initiated by the Shutdown Timer (Shutdown after)

During battery backup time, the Shutdown Timer of the Network Management Card is reached: After a user-defined backup time period ([Shutdown parameters](#) page), the shutdown of all servers is initiated, followed by the UPS shutdown (depending on its configuration). The UPS restarts when utility power is restored (depending on its configuration)

Shutdown duration: Maximum value of shutdown times of protection application subscribed to the card. This value is updated each time a client subscribes/ unsubscribes.

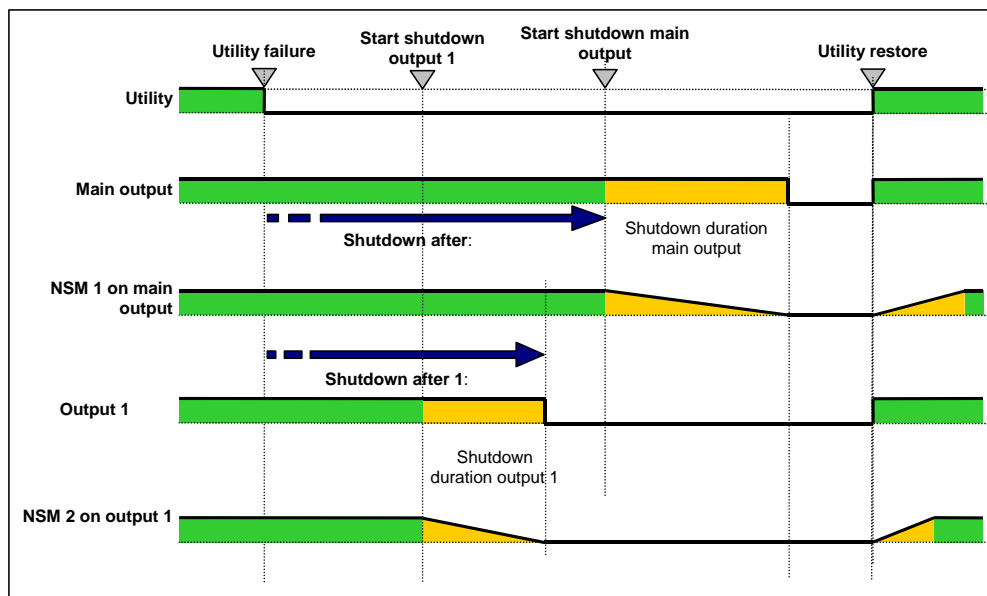

5.2.2 Extended power outage, shutdown initiated by the "Low battery power" message

When the "Low battery power" criterion is displayed, the UPS is shut off after taking into account the shutdown duration of the servers.

"Low battery power": The message appears if either of the two following criteria is reached:

- Low Battery Level
- Low Battery Delay

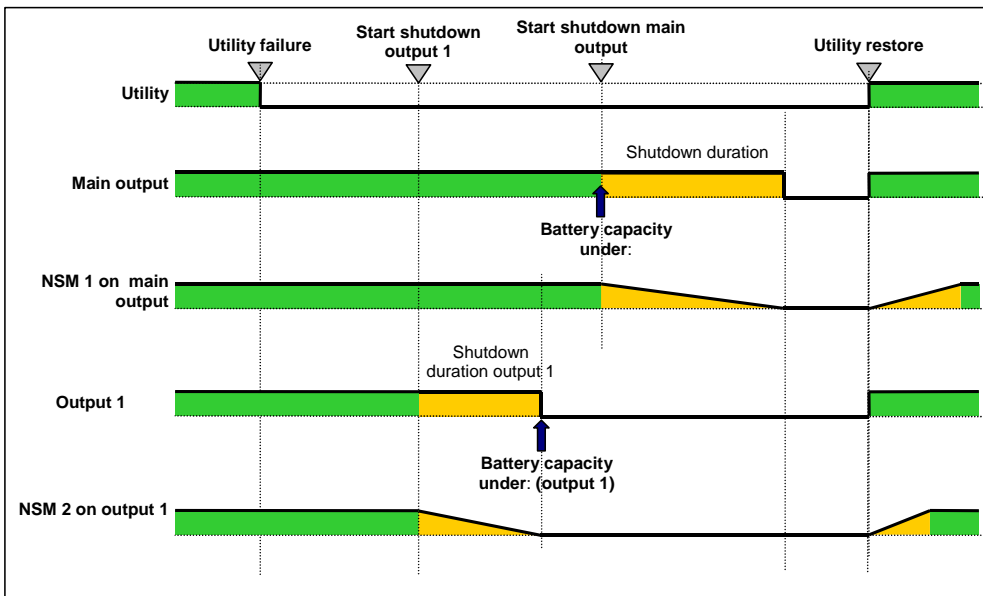

5.2.3 Case of power restoration before the end of the "shutdown duration" counter

If power is restored before the end of the Shutdown Duration, the UPS is shut off after the Shutdown Duration for a time equal to the forced reboot delay (10 seconds)

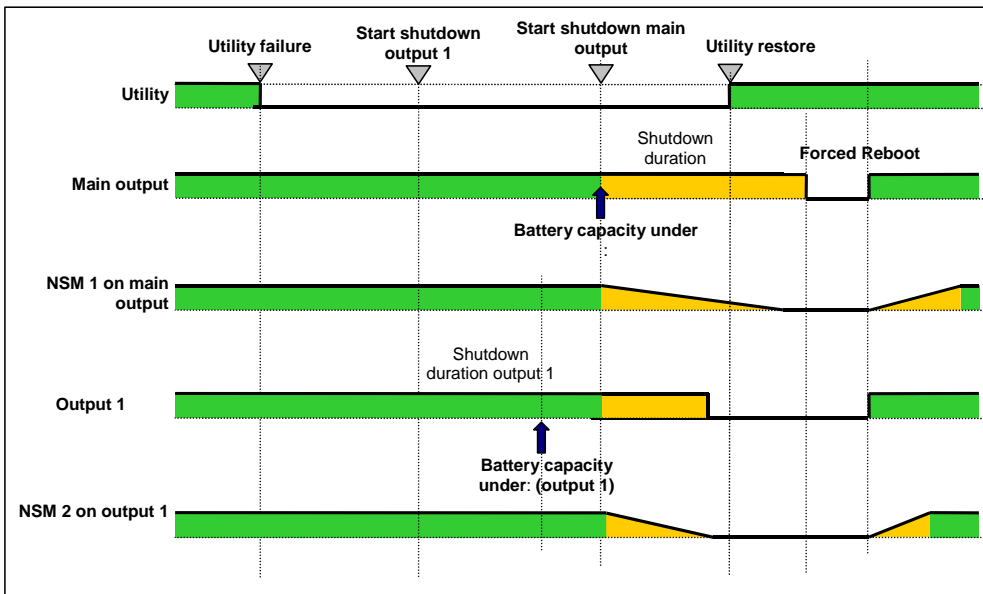

5.3 Shutdown management with 2 NMC boards

Certain UPS can have 2 NMC boards in order to:

- Increase the number of protected servers,
- Protect 2 groups of server connected to different networks physically separated.

5.3.1 Shutdown Duration

As described in the 5.1.1.4 paragraph, the protection application transmit their own "Shutdown duration" to the Network Management Card. Based on these values (maximum Shutdown duration of all subscribed customer systems) that the card will send to the delayed shutdown order to the UPS.

If the UPS have two NMC cards, the maximum shutdown duration of the two groups of protected systems will be used for the delayed shutdown order.

Example: If the subscribed customers of the first NMC card have a maximum Shutdown duration of 60s and the ones of the second NMC card of 120s, the servers shutdown will be launched 120s before the UPS shutoff..

5.3.2 Settings

Set-up shutdown parameters to the same value on the 2 cards are highly recommended (for the main output and the controlled outlets).

If the settings are not the same, the first criteria reached on one the 2 cards will launch the secure shutdown of all servers

Please, note that in any case the shutdown of the protected servers will be executed safely.

6 TELNET/SSH/CLI interfaces

6.1 Introduction

This chapter describes how to use the Telnet/SSH/CLI interfaces of the IBM Network Management Card.

6.2 Settings list

The parameters accessible via Telnet, SSH or CLI are the same as those offered by WEB interface.

The use of these parameters remains the same. For more explanation about these parameters, the default values, possible values, please refer to the previous chapter (§4 - Supervision and administration by browser) of this document

6.2.1 Network settings

These settings enable the administrator to configure the network parameters of the card and authorisation of the remote upgrade of the embedded system.

The parameter list is the following:

- MAC address (read only)
- IP address
- Subnet mask
- Gateway address
- Host name
- Domain name
- BOOTP/DHCP
- IPv6
- IPv6 autoConfig
- IPv6 address 1
- IPv6 prefix length
- IPv6 Gateway address
- IPv6 local address (read only)
- IPv6 address 2 (read only)
- Updating software
- Primary DNS server
- Secondary DNS server
- SMTP server
- SMTP port
- SMTP server authentication
- SMTP login
- SMTP password

6.2.2 System settings

These settings enable the customisation of the information on the UPS properties pages.

The parameter list is the following:

- UPS contact
- UPS location
- History log interval
- Environment log interval
- Default language

6.2.3 Trap receivers

This is the list of the supervision stations receiving traps. There is a maximum of 3 trap receivers.

The parameter list is the following:

- Receiver 1, 2 or 3 :
 - Application name
 - Host name
 - Trap port
 - Protocol
 - Trap community
 - MIB filter

6.2.4 Access control

These settings enable the configuration for secure access to the card via a web browser or SNMP. This menu can also define Telnet/SSH/CLI procedure to access to the card.

The parameter list is the following:

- Login
- Password
- Security mode
- Telnet access
- Telnet security
- Console interface

6.2.5 Shutdown settings

These settings are used to define the behaviour of the UPS during a shutdown.

The parameter list is the following:

- Outlet 1 (main):
 - Name
 - Remaining time limit
 - Remaining capacity limit
 - Shutdown after

- Shutdown timer selected
- Shutdown duration
- Battery capacity exceeds
- Outlet 2 & 3:
 - Name
 - Switch off after
 - Remaining capacity limit
 - Shutdown duration
 - Switch on after

6.2.6 Authentication settings

6.2.7 RADIUS settings

This is the list of Radius Servers. There is a maximum of 2 servers.

The parameter list is the following:

- Radius Server Primary&Secondary:
 - Radius Server
 - Secret
 - NAS IP Address
 - Auth. Port
 - Time Out
 - Retry Number

6.2.8 LDAP settings

This is the list of LDAP Settings.

The parameter list is the following:

- Authentication Mechanism
- User Search Bind
- Search User
- Search User Password
- User Base DN
- User Object
- User Attribute
- Authorization Mode
- UPS Group Base DN
- Group Name Attribute
- User Name Attribute
- LDAP Server Primary&Secondary:
 - Server Name

- Port
- Time Out

6.2.9 SNMP settings

These settings configure the 2 SNMP versions available, v1 and v3.

The parameter list is the following:

- Version
- SNMP port
- SNMP v1 community Read-Only
- SNMP v1 write enables
- SNMP v1 community write
- SNMP v3 user Read-Only
- SNMP v3 security Read-Only
- SNMP v3 password Read-Only
- SNMP v3 user Read-Write
- SNMP v3 security Read- Write
- SNMP v3 password Read- Write
- Notification user name

6.2.10 Date and time

These settings enable the initialisation of the date and time of the card in three different ways.

The parameter list is the following:

- Date & Time
- Type of synchronisation
- NTP host name
- Time-Zone
- Daylight saving time

6.2.11 Environment settings

These settings enable the configuration of the environment sensor. If not present, this menu is not available.

The parameter list is the following:

- Sensor name
- Temperature:
 - Unity
 - High threshold
 - Low threshold
 - Hysteresis
 - Offset
 - High notify

- Low notify
- High shutdown
- Low shutdown
- Humidity:
 - High threshold
 - Low threshold
 - Hysteresis
 - Offset
 - High notify
 - Low notify
 - High shutdown
 - Low shutdown
- Input#1:
 - Identifier
 - Close label
 - Close notify
 - Close shutdown
 - Open label
 - Open notify
 - Open shutdown
- Input#2:
 - Identifier
 - Close label
 - Close notify
 - Close shutdown
 - Open label
 - Open notify
 - Open shutdown

6.3 Menu interface

The setting parameter “HMI Type” defines which HMI will be available. To use the menu interface, this parameter has to be equal to “MENU”.

The menu interface is defined with menus and submenus. It is available with the 2 protocols, Telnet and SSH.

The only language implemented is English.

For simplicity, the settings are sorted in the same way as the Web interface.

According to the current configuration, some settings may be read-write, read-only, write-only or hidden.

In each screen, it is possible to close the session with the command “quit”.

The code colour is the following:

- Settings in read-write or write-only mode: light green.

- Settings in read-only mode: yellow.
- Warning message: green.
- Error message: light red.

6.3.1 Tree description

- Main menu
 - Reset menu
 - Network menu
 - MAC address
 - ../..
 - SMTP menu
 - Host name
 - ../..
 - SNMP menu
 - Version
 - ../..
 - Trap receivers
 - Receiver 1
 - Host name
 - ../..
 - Receiver 2
 - Host name
 - ../..
 - Receiver 3
 - Host name
 - ../..
 - System menu
 - UPS contact
 - ../..
 - Shutdown menu
 - Master
 - Name
 - ../..
 - Outlet 2
 - Name
 - ../..
 - Outlet 3
 - Name
 - ../..
 - Access Control menu
 - Login
 - ../...
 - Date & Time menu
 - Date
 - ../..
 - Environment menu
 - Sensor Name
 - Temperature
 - Unity
 - ../..
 - Humidity
 - High Threshold
 - ../..
 - Input#1
 - Identifier
 - ../..
 - Input#2
 - Identifier
 - ../..
- Authentication settings menu
 - Authentication Methode
 - Authentication Order

Network Management Card (Network-MS) User Manual

- Session Time
 - Max Session Time
 - Radius Menu Primary Server: Enable
 - Radius Menu Primary Server: Name
 - Radius Menu Primary Server: Secret
 - Radius Menu Primary Server: Port
 - Radius Menu Primary Server: NAS
 - Radius Menu Primary Server: Retry
 - Radius Menu Primary Server: TimeOut
 - Radius Menu Secondary Server: Enable
 - Radius Menu Secondary Server: Name
 - Radius Menu Secondary Server: Secret
 - Radius Menu Secondary Server: Port
 - Radius Menu Secondary Server: NAS
 - Radius Menu Secondary Server: Retry
 - Radius Menu Secondary Server: TimeOut
 - LDAP Menu Primary Server: Enable
 - LDAP Menu Primary Server: Name
 - LDAP Menu Primary Server: Port
 - LDAP Menu Secondary Server: Enable
 - LDAP Menu Secondary Server: Name
 - LDAP Menu Secondary Server: Port
 - LDAP Menu Mechanism
 - LDAP Menu Search Mode
 - LDAP Menu Search User Distinguished Name
 - LDAP Menu Search User Password
- Login password to default
 - Default Configuration

6.3.2 Main menu

This screen is the main screen displayed when the connection is established.

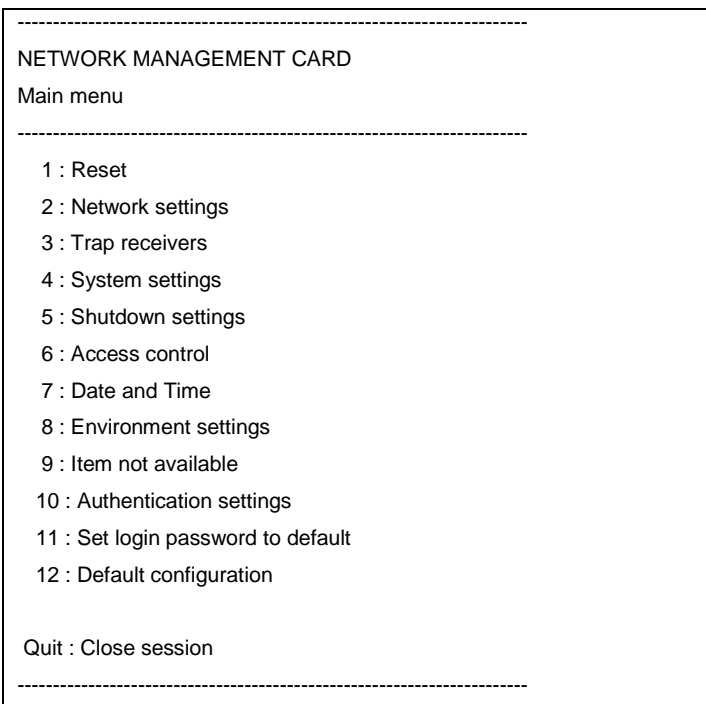

6.3.3 Reset item

This menu item is used to reset the card. It is not possible to reset the card when a flash write process is in progress. When a reset operation is completed, a prompt is displayed to confirm the reset.

6.3.4 Network menu

This menu is used to view or modify the network settings.

```
-----  
NETWORK MANAGEMENT CARD  
Network settings  
-----  
  : MAC address [00:20:85:FD:1C:07] (3)  
1 : BootP/DHCP (0=Disabled, 1=Enabled) [1]  
2 : IP Address [xxx.xxx.xxx.xxx] (1)  
3 : Subnet Mask [xxx.xxx.xxx.xxx] (1)  
4 : Gateway Address [xxx.xxx.xxx.xxx] (1)  
5 : Host Name [ups1]  
6 : UPS Domain Name [ups.domain.com]  
7 : IPv6 (0=No, 1=Yes) [0]  
8 : IPv6 Auto-config (0=No, 1=Yes) [0] (2)  
9 : IPv6 add.1/prefix len. [ ] (3)(5)  
10 : IPv6 gateway address [ ] (3)  
11 : IPv6 local address (4)  
12 : IPv6 address 2 (4)  
13 : Firmware upgradable (0=No, 1=Yes) [1]  
14 : Primary DNS Server (IPv4 or IPv6) [xxx.xxx.xxx.xxx]  
15 : Secondary DNS Server [xxx.xxx.xxx.xxx]  
16 : SMTP menu  
17 : SNMP menu  
  
0 : Exit  
-----
```

- (1) Read-only or read-write according to "BootP/DHCP" status
- (2) Read-only or read-write according to "IPv6 enabled" status
- (3) Read-only or read-write according to "IPv6 enabled" and "IPv6 auto-config" status
- (4) Read-only
- (5) The value is a concatenation of the IPv6 address 1 and of the prefix length.

```
-----  
NETWORK MANAGEMENT CARD  
Network settings - SMTP  
-----  
 1 : Hostname (for Email notification) [smtpserver]  
 2 : SMTP Port (Default Value: 25) [25]  
 3 : Authentication (0=No, 1=Yes) [1]  
 4 : Login [smtplogin] (1)  
 5 : Password [*****] (2)  
  
0 : Exit  
-----
```

- (1) Read-only or read-write according to "Authentication" status
- (2) Write-only or hidden according to "Authentication" status

```
-----  
NETWORK MANAGEMENT CARD  
Network settings - SNMP  
-----  
  
1 : Version (Disabled, V1, V3, V1V3) [V1V3]  
2 : SNMP port (Default value: 161) [161]  
  
** About V1 **  
3 : Community read-only [publicuser]  
4 : SNMP write (0=No, 2=Yes) [2]  
5 : Community write [privateuser] (1)  
  
** About V3 **  
6 : Read-only user [readuser]  
7 : R/O security (1=No Auth, 2=Auth NoPriv, 3=Auth Priv) [2]  
8 : Read-only password [*****] (2)  
9 : Read-Write user [writeuser]  
10 : R/W security (1=No Auth, 2=Auth NoPriv, 3=Auth Priv) [2]  
11 : Read-Write password [*****] (3)  
12 : Notification user name [notifuser]  
  
0 : Exit  
-----
```

All items from 3 to 11 are read-write or masqued according to "Version" status.

- (1) Read-write or read-only according to "SNMP write" status;
- (2) Write-only or hidden according to "R/O security" status; the length has to be 8 characters at least;
- (3) Write-only or hidden according to "R/W security" status; the length has to be 8 characters at least.

6.3.5 Trap receivers menu

This menu is used to view or modify the applications receiving traps and to configure trap type.

```
-----  
NETWORK MANAGEMENT CARD  
Trap receiver  
-----  
  
1 : Receiver 1  
2 : Receiver 2  
3 : Receiver 3  
  
0 : Exit  
-----
```

```
-----  
NETWORK MANAGEMENT CARD  
Trap receiver X  
-----  
 1 : Hostname or IP address [xxx. xxx. xxx. xxx]  
 2 : Application mane [MyTrap]  
 3 : Trap Port (Default value: 162) [162 ]  
 3 : Trap community [ ]  
 4 : Protocol (Disabled, V1, V3, V1V3) [Disabled]  
 5 : MIB filter (b0=Pulsar, bit1=Power MIB, bit2=IETF) [2] (1)  
  
 0 : Exit  
-----
```

(1) Only the 3 less significant bits are used (b0 to b2). The possible value are from 0 to 7 (3 bits used set to 1).

6.3.6 System menu

This menu is used to view or modify the system settings.

```
-----  
NETWORK MANAGEMENT CARD  
System settings  
-----  
 1 : UPS contact [Computer Room Manager]  
 2 : UPS Location [Room Manager]  
 3 : Item not available  
 4 : History log interval (sec) [50]  
 5 : Environment log interval (sec) [300]  
 6 : Item not available  
 7 : Language (AUTO,FRE,ENG,SPA, GER,ITA,CHI,CHT,JPN,KOR,CZI,RUS,POR) [AUTO]  
  
 0 : Exit  
-----
```

6.3.7 Shutdown menu

This menu is used to view or modify the shutdown settings for the 3 outlets.

```
-----  
NETWORK MANAGEMENT CARD  
Shutdown settings  
-----  
 1 : Master  
 2 : Outlet 2  
 3 : Outlet 3  
  
 0 : Exit  
-----
```

```
-----  
NETWORK MANAGEMENT CARD  
Shutdown settings - Master  
-----  
1 : Name [Master]  
2 : Shutdown if remaining time under (sec) [180]  
3 : Shutdown if capacity under (%) [20]  
4 : Shutdown timer enabled (0=No, 1=Yes) [0]  
5 : Shutdown timer (sec) [1800]  
6 : Shutdown duration (sec) [120]  
7 : Restart if capacity exceed (%) [0]  
  
0 : Exit  
-----
```

```
-----  
NETWORK MANAGEMENT CARD  
Shutdown settings – Outlet 1  
-----  
1 : Name [Group1]  
2 : Switch off after (sec) [2147483647]  
3 : Switch off if capacity under (%) [0]  
4 : Shutdown duration (sec) [120]  
5 : Switch on after (sec) [0]  
  
0 : Exit  
-----
```

6.3.8 Access Control menu

This menu defines the accessibility of the card by a client.

```
-----  
NETWORK MANAGEMENT CARD  
Access settings  
-----  
1 : New Login [MyName]  
2 : Password [*****] (1)  
3 : Security Mode (1=conf., 2=full auth., 3=full auth. & SSL) [1]  
4 : Telnet access enabled (0=No, 1=Yes) [1]  
5 : Telnet security enabled (0=No, 1=Yes) [0] (2)  
6 : Console interface (Menu, CLI) [Menu] (2)  
  
0 : Exit  
-----
```

(1) Write-only and encrypted

(2) Read-write or read-only according to “Telnet access enabled” status.

6.3.9 Date and time menu

This menu defines the date and time management.

```
-----  
NETWORK MANAGEMENT CARD  
Date & Time settings  
-----  
 1 : Date (yyyy/mm/dd) [2010/11/05] (1)  
 2 : Hour (HH:MM:SS) [11:30:00] (1)  
 3 : Type of synchronization (MANUAL, AUTO, NTP) [MANUAL]  
 4 : Host Name [ntpserver]  
 5 : Time zone (+/-hh:mm) [ 0: 0] (2)  
 6 : Day light enabled (0=No, 1=Yes) [0]  
  
 0 : Exit  
-----
```

(1) Read-write or read-only according to “Type of synchronization” status

(2) Setting resolves to the nearest half hour; for example, sending +02:36 results in +02:30, and sending +02:46 results in +03:00.

6.3.10 Environment menu

These menus define the settings of the environment sensor.

```
-----  
NETWORK MANAGEMENT CARD  
Environment settings  
-----  
 1 : Sensor Name [My Sensor]  
 2 : Temperature  
 3 : Humidity  
 4 : Input #1  
 5 : Input #2  
  
 0 : Exit  
-----
```

NETWORK MANAGEMENT CARD

Environment settings - Temperature

- 1 : Unity (C=Celsius, F=Fahrenheit) [C]
- 2 : High Threshold [40]
- 3 : Low Threshold [5]
- 4 : Hysteresis [2]
- 5 : Offset [0.0]
- 6 : High notify (0=No, 1=Yes) [0]
- 7 : Low notify (0=No, 1=Yes) [0]
- 8 : High shutdown (0=No, 1=Yes) [0]
- 9 : Low shutdown (0=No, 1=Yes) [0]

0 : Exit

NETWORK MANAGEMENT CARD

Environment settings - Humidity

- 1 : High Threshold [90]
- 2 : Low Threshold [5]
- 3 : Hysteresis [5]
- 4 : Offset [0.0]
- 5 : High notify (0=No, 1=Yes) [0]
- 6 : Low notify (0=No, 1=Yes) [0]
- 7 : High shutdown (0=No, 1=Yes) [0]
- 8 : Low shutdown (0=No, 1=Yes) [0]

0 : Exit

```
-----  
NETWORK MANAGEMENT CARD  
Environment settings – Input #1  
-----  
1 : Identifier [Fan1]  
  
*** State 0 ***  
2 : Label [Fan running]  
3 : Notify (0=No, 1=Yes) [0]  
4 : Shutdown (0=No, 1=Yes) [0]  
  
*** State 1 ***  
5 : Label [Fan stopped]  
6 : Notify (0=No, 1=Yes) [0]  
7 : Shutdown (0=No, 1=Yes) [0]  
  
0 : Exit  
-----
```

6.3.11 Authentication settings

These menus define the settings of the authentication.

```
-----  
EATON NETWORK MANAGEMENT CARD  
Authentication settings  
-----  
1 : Authentication Method (LOCAL, RADIUS, LDAP) [LDAP]  
2 : Authentication Order (Local_Only, Local_External, External_Local, External_Only) [Local_External] (1)  
3 : Session Time (s) [300]  
4 : Max Session Time (s) [9999]  
5 : Radius menu  
6 : LDAP menu  
  
0 : Exit  
-----
```

(1) Read-write or read-only according to “Authentication Method” status

Network Management Card (Network-MS) User Manual

EATON NETWORK MANAGEMENT CARD

Radius settings ⁽¹⁾

*** About Primary Server ***

- 1 : Enable (0=No, 1=Yes) [0]
- 2 : Name [] ⁽²⁾
- 3 : Secret ⁽²⁾
- 4 : Port [1812] ⁽²⁾
- 5 : NAS (IPV4, IPV6_1, IPV6_2, IPV6_LOCAL) [IPV4] ⁽²⁾
- 6 : Retry [3] ⁽²⁾
- 7 : TimeOut (s) [10] ⁽²⁾

*** About Secondary Server ***

- 8 : Enable (0=No, 1=Yes) [0]
- 9 : Name [] ⁽³⁾
- 10 : Secret ⁽³⁾
- 11 : Port [1812] ⁽³⁾
- 12 : NAS (IPV4, IPV6_1, IPV6_2, IPV6_LOCAL) [IPV4] ⁽³⁾
- 13 : Retry [3] ⁽³⁾
- 14 : TimeOut (s) [10] ⁽³⁾

0 : Exit

- (1) Read-write or read-only according to "Authentication Method" status
- (2) Read-write or read-only according to "Enable" and "Authentication Method" status of the Primary Server
- (3) Read-write or read-only according to "Enable" and "Authentication Method" status of the Secondary Server

EATON NETWORK MANAGEMENT CARD

LDAP settings⁽¹⁾

*** About Primary Server ***

- 1 : Enable (0=No, 1=Yes) [1]
- 2 : Name [10.130.32.6]⁽²⁾
- 3 : Port [389]⁽²⁾

*** About Secondary Server ***

- 4 : Enable (0=No, 1=Yes) [0]
- 5 : Name []⁽³⁾
- 6 : Port [389]⁽³⁾

*** About binding ***

- 7 : Mechanism (SIMPLE, DIGEST-MD5) [SIMPLE]
- 8 : Search Mode (ANONYMOUS, USERBIND) [USERBIND]
- 9 : Search User Distinguished Name
- 10 : Search User Password [*****]⁽⁴⁾

- 0 : Exit
-

- (1) Read-write or read-only according to "Authentication Method" status
- (2) Read-write or read-only according to "Enable" status of the Primary Server
- (3) Read-write or read-only according to "Enable" status of the Secondary Server
- (4) Read-write or read-only according to "Search Mode" status

6.3.12 Return to default Login/Password

If the login or password is lost, select this option to enable the return to the default Login/Password.

6.3.13 Return to default configuration

This item is used to return to default configuration which is described in this document.

The NMC card is automatically restarted after returns to default configuration.

6.4 Command Line Interface

Command Line Interface (CLI) API provides functions for building and processing a user-defined HMI. To use the CLI, the parameter "HMI type" has to be equal to "CLI".

When opening a new session, TELNET or SSH, a specific prompt "#>" is sent to the client. The user can enter a command. If the command is recognized, it is processed, else a warning message is sent to the client.

The syntax used is based on that already implemented for the XML description of objects. The blank character is

Network Management Card (Network-MS)

User Manual

not allowed in command arguments except for the strings. The strings are in double quotes (“”).

The code colour is the following:

- Setting in read-write or write-only mode: light green
- Setting in read-only mode: yellow
- Warning message: green
- Error message: light red

The recognized commands are given in the following chapters and may be updated later.

6.4.1 Generic command

6.4.1.1 “help” and “?”

Purpose	Display help about a specific command.
Syntax	help [command] or [command] ?
Examples	#> help getNetwork #> getNetwork ?

6.4.1.2 “setEcho”

Purpose	Hide, or not, all characters. If hidden, each character entered is replaced by an ‘*’
Syntax	setEcho [option] option : ON OFF
Examples	#> setEcho ON

6.4.1.3 “quit”

Purpose	Close a current CLI session
Syntax	quit
Examples	#> quit

6.4.1.4 “reset”

Purpose	Software reset
Syntax	reset
Examples	#> reset

6.4.1.5 “version”

Purpose	Get information about software versions
Syntax	version
Examples	#> version

6.4.1.6 “defaultPass”

Purpose	Returns to default Login/Password
Syntax	defaultPass
Examples	#> defaultPass

6.4.1.7 “defaultConf”

Purpose	Returns to default Configuration
Syntax	defaultConf
Examples	#> defaultConf
Comments	The card is automatically reset.

6.4.2 Network settings

6.4.2.1 “getNetwork”

Purpose	To read a network setting
Syntax	<pre>getNetwork [option1] [option2]...</pre> <p>options :</p> <ul style="list-style-type: none"> DHCP IPAddress IPMask IPGateway HostName DomainName IPv6Enable IPv6AutoConf IPv6Address1 IPv6DefaultGateway IPv6LocalAddress IPv6Address2 PrimaryDNS SecondaryDNS FirmwareUpgrade
Examples	#> getNetwork IPAddress

6.4.2.2 “setNetwork”

Purpose	To modify a network setting
Syntax	<pre>setNetwork [option1=xxxx] [option2=yyyy]...</pre> <p>options :</p> <ul style="list-style-type: none"> DHCP = 0 1 (0=No, 1=Yes) IPAddress = “xxx.xxx.xxx.xxx” (1)

Network Management Card (Network-MS) User Manual

	<p>IPMask = "xxx.xxx.xxx.xxx" ⁽¹⁾</p> <p>IPGateway = "xxx.xxx.xxx.xxx" ⁽¹⁾</p> <p>HostName = "xx..xx"</p> <p>DomainName = "xx..xx"</p> <p>IPv6Enable = 0 1 (0=No, 1=Yes)</p> <p>IPv6AutoConf = 0 1 (0=No, 1=Yes) ⁽²⁾</p> <p>IPv6Address1 = "xx.xx/xxx" ⁽³⁾⁽⁴⁾</p> <p>PrefixLength = xx ⁽³⁾</p> <p>IPv6DefaultGateway [=] ⁽³⁾</p> <p>PrimaryDNS = "xx..xx"</p> <p>SecondaryDNS = "xx..xx"</p> <p>FirmwareUpgrade = 0 1 (0=No, 1=Yes)</p>
Examples	#> setNetwork IPAddress=xxx.xxx.xxx.xxx IPMask= xxx.xxx.xxx.xxx
Comments	<p>⁽¹⁾ : Writing enabled according to "DHCP" status</p> <p>⁽²⁾ : Writing enabled according to "IPv6Enable" status</p> <p>⁽³⁾ : Writing enabled according to "IPv6AutoConf" status</p> <p>⁽⁴⁾ : The value is a concatenation of IPv6 address 1 and prefix length</p>

6.4.2.3 "getSMTP"

Purpose	To read a SMTP setting
Syntax	<p>getSMTP [option1] [option2]...</p> <p>options :</p> <p> HostName</p> <p> Smtport</p> <p> Authentication</p> <p> Login</p> <p> Password ⁽¹⁾</p>
Examples	#> getSMTP HostName
Comments	⁽¹⁾ : All characters are replaced with the star character "*" (asterisk).

6.4.2.4 "setSMTP"

Purpose	To modify a SMTP setting
Syntax	<p>setSMTP [option1=xxxx] [option2=yyyy]...</p> <p>options :</p> <p> HostName = "xx..xx"</p> <p> Smtport = xx (Default value: 25) (1..65535)</p> <p> Authentication = 0 1 (0=No, 1=Yes)</p> <p> Login = "xx..xx" ⁽¹⁾</p> <p> Password = "*** ..**" ⁽¹⁾⁽²⁾</p>

Network Management Card (Network-MS) User Manual

Examples	#> setSMTP HostName = "SmtP Server"
Comments	(1) : Writing enabled according to "Authentication" status (2) : Don't forget to set echo off

6.4.2.5 "getSNMP"

Purpose	To read a SNMP setting
Syntax	getSNMP [option1] [option2]... options : snmpVersion snmpPort ReadCommunityName WriteCommunitySecurityLevel WriteCommunityName User UserSecurityLevel UserPassword (1) Admin AdminSecurityLevel AdminPassword (1) NotificationUserName FirmwareUpgrade
Examples	#> getSNMP User
Comments	(1) : All characters are replaced with the star character '*'

6.4.2.6 "setSNMP"

Purpose	To modify a SNMP setting
Syntax	setSNMP [option1] [option2]... options : snmpVersion = Disabled V1 V3 V1V3 snmpPort = xx (Default value: 161) (1..65535) ReadCommunityName = "xx..xx" (1) WriteCommunitySecurityLevel = 0 2 (0=No, 2=Yes) (*) WriteCommunityName = "xx..xx" (1)(2) User = "xx..xx" (1) UserSecurityLevel = 1 2 3 (1=No Auth, 2=Auth NoPriv, 3=Auth Priv) (1) UserPassword = "xx..xx" (1)(3)(5)(6) Admin = "xx..xx" (1) AdminSecurityLevel = 1 2 3 (1=No Auth, 2=Auth NoPriv, 3=Auth Priv) (1) AdminPassword = "xx..xx" (1)(4)(5)(6)

	NotificationUserName = "xx.xx" FirmwareUpgrade = 0 1 (0=No, 1=Yes)
Examples	#> setSNMP User = "readuser"
Comments	(1) : Writing enabled according to "snmpVersion" status (2) : Writing enabled according to "WriteCommunitySecurityLevel" status (3) : Writing enabled according to "UserSecurityLevel" status (4) : Writing enabled according to "AdminSecurityLevel" status (5) : Don't forget to set echo off (6) : The length has to be 8 characters at least.

6.4.3 Trap receivers

6.4.3.1 "getTrap"

Purpose	To read a trap receiver setting
Syntax	getTrap N [option1] [option2]... N = 0 1 2 options : Name HostName TrapPort TrapSnmpVersion TrapCommunity TrapSelectedMibs
Examples	#> getTrap HostName Name
Comments	

6.4.3.2 "SetTrap"

Purpose	To modify a trap receiver setting
Syntax	setTrap N [option1] [option2]... N = 0 1 2 options : Name = "xx..xx" HostName = "xx..xx" TrapPort = xx (Default value: 162) (1..65535) TrapSnmpVersion = Disabled V1 V3 V1V3 TrapCommunity = "xx..xx" TrapSelectedMibs = 0 1 2 3 4 5 6 7 ⁽¹⁾
Examples	#> setTrap 0 Name="My application"
Comments	(1) : bit0 = 1 : MIB Pulsar enabled bit1 = 1 : Power MIB enabled

	bit2 = 1 : MIB IETF enabled
--	-----------------------------

6.4.4 System settings

6.4.4.1 “getSystem”

Purpose	To read a system setting
Syntax	getSystem [option1] [option2]... options : Contact Location upsCustomName Language
Examples	#> getSystem Location
Comments	

6.4.4.2 “setSystem”

Purpose	To modify a system setting
Syntax	setSystem [option1] [option2]... options : Contact = “xx..xx” Location = “xx..xx” upsCustomName = “xx..xx” Language = AUTO FRE ENG SPA GER ITA CHI CHT JPN KOR CZI RUS POR
Examples	#> setSystem Location="my office"
Comments	

6.4.4.3 “getHistSyst”

Purpose	To read a history system setting
Syntax	getHistSyst [option] options : Interval
Examples	#> getHistSyst Interval
Comments	

6.4.4.4 “setHistSyst”

Purpose	To modify a history system setting
Syntax	setHistSyst [option] options : Interval = xx (10..2147483647 in s)

Examples	#> setHistSyst Interval=12
Comments	

6.4.4.5 “getEnvSyst”

Purpose	To read a environment system setting
Syntax	getEnvSyst [option1] [option2] options : Interval Delimiter
Examples	#> getEnvSyst Delimiter
Comments	

6.4.4.6 “setEnvSyst”

Purpose	To modify a environment system setting
Syntax	setEnvSyst [option1] [option2] options : Interval = xx (10..2147483647 in s) Delimiter = Comma Tab
Examples	#> setEnvSyst Delimiter = Comma
Comments	

6.4.5 Shutdown settings

6.4.5.1 “getShutdown”

Purpose	To read a shutdown setting
Syntax	getShutdown N [option1] [option2] ... N = 1 2 3 options for N=1: iName RunTimeToEmptyLimit RemainingCapacityLimit ShutdownTimerSelected ShutdownTimer ShutdownDuration RestartLevel options for N=2 or 3: iName ShutdownTimer RemainingCapacityLimit ShutdownDuration

	StartupTimer
Examples	#> getShutdown 1 ShutdownDuration
Comments	

6.4.5.2 “setShutdown”

Purpose	To modify a shutdown setting
Syntax	<p>setShutdown N [option1] [option2] ...</p> <p>N = 1 2 3</p> <p>options for N=1:</p> <p>iName = “xx..xx”</p> <p>RunTimeToEmptyLimit = xx (0..9999 in sec)</p> <p>RemainingCapacityLimit = xx (0..100 in sec)</p> <p>ShutdownTimerSelected = 0 1 (0=No, 1=Yes)</p> <p>ShutdownTimer = xx (0..5999940/60 in min)</p> <p>ShutdownDuration = xx (0..999 in sec)</p> <p>RestartLevel = xx (0..100 %)</p> <p>options for N=2 or 3:</p> <p>iName = “xx..xx”</p> <p>ShutdownTimer = xx (99..99999 in sec)</p> <p>RemainingCapacityLimit = xx (0..100 in sec)</p> <p>ShutdownDuration = xx (0..999 in sec)</p> <p>StartupTimer = xx (0..65535 in sec)</p>
Examples	#> setShutdown 1 ShutdownDuration=120
Comments	

6.4.6 Access control settings

6.4.6.1 “getAccess”

Purpose	To read an access control setting
Syntax	<p>getAccess [option1] [option2]...</p> <p>options :</p> <p>Login</p> <p>Password ⁽¹⁾</p> <p>Security</p>
Examples	#> getAccess Login
Comments	⁽¹⁾ : All characters are replaced with the star character ‘*’

6.4.6.2 “setAccess”

Purpose	To modify an access control setting
Syntax	setAccess [option1] [option2]

	<p>options :</p> <p>Login = "xx.xx"</p> <p>Password = "***..**" (1)(2)</p> <p>ConfirmPass = "***..**" (1)(2)</p> <p>Security = 1 2 3 (1=conf., 2=full auth., 3=full auth. & SSL)</p>
Examples	#> setAccess Security=3
Comments	<p>⁽¹⁾ : Don't forget to set echo off</p> <p>⁽²⁾ : The 2 passwords entered must be the same for to be taken into account</p>

6.4.6.3 "getTelnet"

Purpose	To read a Telnet setting
Syntax	<p>getTelnet [option1] [option2]...</p> <p>options :</p> <p>Access</p> <p>Security</p> <p>Console</p>
Examples	#> getTelnet Security
Comments	

6.4.6.4 "setTelnet"

Purpose	To modify a Telnet setting
Syntax	<p>setTelnet [option1] [option2]</p> <p>options :</p> <p>Access = 0 1 (0=Disabled, 1=Enabled)</p> <p>Security = 0 1 (0=No, 1=Yes with SSH)</p> <p>Console = CLI Menu</p>
Examples	#> setTelnet Security=0
Comments	

6.4.7 Authentication settings

6.4.7.1 "getAuth"

Purpose	To read an Authentication setting
Syntax	<p>syntax: getAuth [options...]</p> <p>options :</p> <p>SessionTime</p> <p>MaxSessionTime</p> <p>AuthOrder</p> <p>AuthMethod</p>

Examples	#> getAuth SessionTime
Comments	

6.4.7.2 "setAuth"

Purpose	To modify an Authentication setting
Syntax	syntax: setAuth [options...] options: SessionTime=xx <-- in sec. 1..9999 --> MaxSessionTime=xx <-- in sec. 1..9999 --> AuthOrder=Local_Only Local_External External_Local External_Only ⁽¹⁾ AuthMethod=LOCAL RADIUS LDAP
Examples	#> setAuth SessionTime =200
Comments	⁽¹⁾ : Writing enabled according to "AuthMethod" status

6.4.7.3 "getRadPrimSrv"

Purpose	To read an Radius primary server setting
Syntax	syntax: getRadPrimSrv [options...] options: Server Enable <-- 0=No, 1=Yes --> Server ServerName Server SharedSecret Server Port Server NasIdentifierType Server Retry Server Timeout
Examples	#> getRadPrimSrv Port
Comments	

6.4.7.4 "setRadPrimSrv"

Purpose	To modify an Radius primary server setting
Syntax	syntax: setRadPrimSrv [options...] options: Server Enable <-- 0=No, 1=Yes --> ⁽¹⁾ Server ServerName="Server Name" ^{(1) (2)} Server SharedSecret="Shared Secret" ^{(1) (2)} Server Port=xx <-- 1..65535 --> ^{(1) (2)} Server NasIdentifierType=IPV4 IPV6_1 IPV6_2 IPV6_LOCAL ^{(1) (2)} Server Retry=xx <-- 1..9999 --> ^{(1) (2)} Server Timeout=xx <-- 1..9999 --> ^{(1) (2)}
Examples	#> setRadPrimSrv Port =1812

Comments	(1) : Writing enabled according to "AuthMethod" status (2) : Writing enabled according to "Enable" status
----------	--

6.4.7.5 "getRadSecondSrv"

Purpose	To read an Radius secondary server setting
Syntax	syntax: getRadSecondSrv [options...] options: Server Enable <-- 0=No, 1=Yes --> Server ServerName Server SharedSecret Server Port Server NasIdentifierType Server Retry Server Timeout
Examples	#> getRadSecondSrvPort
Comments	

6.4.7.6 "setRadSecondSrv"

Purpose	To modify an Radius secondary server setting ⁽¹⁾
Syntax	syntax: setRadSecondSrv [options...] options: Server Enable <-- 0=No, 1=Yes --> ⁽¹⁾ Server ServerName="Server Name" ^{(1) (2)} Server SharedSecret="Shared Secret" ^{(1) (2)} Server Port=xx <-- 1..65535 --> ^{(1) (2)} Server NasIdentifierType=IPV4 IPV6_1 IPV6_2 IPV6_LOCAL ^{(1) (2)} Server Retry=xx <-- 1..9999 --> ^{(1) (2)} Server Timeout=xx <-- 1..9999 --> ^{(1) (2)}
Examples	#> setRadSecondSrv Port =1812
Comments	(1) : Writing enabled according to "AuthMethod" status (2) : Writing enabled according to "Enable" status

6.4.7.7 "getLDAPPrimSrv"

Purpose	To read an LDAP primary server setting
Syntax	syntax: getLDAPPrimSrv [options...] options: Enable <-- 0=No, 1=Yes --> ServerName Port
Examples	#> getLDAPPrimSrv Port

Comments	
----------	--

6.4.7.8 “setLDAPPrimSrv”

Purpose	To modify an LDAP primary server setting
Syntax	syntax: setLDAPPrimSrv [options...] options: Enable <-- 0=No, 1=Yes --> ⁽¹⁾ ServerName="Server Name" ^{(1) (2)} Port=xx <-- 1..65535 --> ^{(1) (2)}
Examples	#> setLDAPPrimSrv Port =389
Comments	⁽¹⁾ : Writing enabled according to “AuthMethod” status ⁽²⁾ : Writing enabled according to “Enable” status

6.4.7.9 “getLDAPSecondSrv”

Purpose	To read an LDAP secondary server setting
Syntax	syntax: getLDAPSecondSrv [options...] options: Enable <-- 0=No, 1=Yes --> ServerName Port
Examples	#> getLDAPSecondSrv Port
Comments	

6.4.7.10 “setLDAPSecondSrv”

Purpose	To modify an LDAP secondary server setting
Syntax	syntax: setLDAPSecondSrv [options...] options: Enable <-- 0=No, 1=Yes --> ⁽¹⁾ ServerName="Server Name" ^{(1) (2)} Port=xx <-- 1..65535 --> ^{(1) (2)}
Examples	#> setLDAPSecondSrv Port =389
Comments	⁽¹⁾ : Writing enabled according to “AuthMethod” status ⁽²⁾ : Writing enabled according to “Enable” status

6.4.7.11 “getLDAPSearch”

Purpose	To read the Search LDAP setting
Syntax	syntax: getLDAPSearch [options...] options: AuthMechanism SearchMode

	SearchUser SearchUserPassword UserBaseSearchDn UserObject UserAttr AuthzMode UPSGroupNameAttr UserNameAttr GroupBaseSearchDn
Examples	#> getLDAPSearch AuthMechanism
Comments	

6.4.7.12 " setLDAPSearch"

Purpose	To modify the Search LDAP setting
Syntax	syntax: setSearchLDAP [options...] options: AuthMechanism=SIMPLE DIGEST-MD5 ⁽¹⁾ SearchMode=ANONYMOUS USERBIND ⁽¹⁾ SearchUser="Search User (Distinguished Name)" ^{(1) (2)} SearchUserPassword="Password" ^{(1) (2)} UserBaseSearchDn="User Base Search Dn" ⁽¹⁾ UserObject="User Object" ⁽¹⁾ UserAttr="User Attribute" ⁽¹⁾ AuthzMode=NONE USER GROUP ⁽¹⁾ UPSGroupNameAttr="UPS Group Name Attribute" ^{(1) (3)} UserNameAttr="User Name Attribute" ^{(1) (3)} GroupBaseSearchDn="Group Base Search DN" ^{(1) (3)}
Examples	#> setLDAPSearch SearchMode =USERBIND
Comments	⁽¹⁾ : Writing enabled according to "AuthMethod" status ⁽²⁾ : Writing enabled according to "SearchMode" status ⁽³⁾ : Writing enabled according to "AuthzMode" status

6.4.8 Date and time settings

6.4.8.1 "getDate"

Purpose	To read a date and time setting
Syntax	getDate [option1] [option2]... options : Date

	Time TimeSync TimeNtp TimeZone TimeDaylight
Examples	#> getDate timeSync
Comments	

6.4.8.2 “setDate”

Purpose	To modify a date and time setting
Syntax	setDate [option1] [option2]... options : Date = yyyy/mm/dd ⁽¹⁾ Time = hh:mm:ss ⁽¹⁾ TimeSync = MANUAL AUTO NTP TimeNtp = “xx.xx” TimeZone = +/-hh:mm ⁽²⁾ TimeDaylight = 0 1 (0=No, 1=Yes)
Examples	#> setDate TimeSync=MANUAL
Comments	⁽¹⁾ : Writing enabled according to “TimeSync” status ⁽²⁾ : The smallest granularity is half an hour; for a bad value, the nearest value is taken into account

6.4.9 Environment settings

6.4.9.1 “getEnv”

Purpose	To read an environment setting
Syntax	getEnv [option1] options : Name
Examples	#> getEnv Name
Comments	

6.4.9.2 “setEnv”

Purpose	To modify an environment setting
Syntax	setEnv [option1] options : Name = “xx.xx”
Examples	#> setEnv Name=”sensor”
Comments	

6.4.9.3 “getTemp”

Purpose	To read a temperature setting
Syntax	getTemp [option1] [option2] ... options : Unit HighThreshold LowThreshold Hysteresis Offset HighNotify LowNotify HighShutdown LowShutdown
Examples	#> getTemp Unit
Comments	

6.4.9.4 “setTemp”

Purpose	To modify a temperature setting
Syntax	setTemp [option1] [option2] ... options : Unit = C K HighThreshold = xx LowThreshold = xx Hysteresis = xx (0..5) Offset = xx (-5..5) HighNotify = 0 1 (0=No, 1=Yes) LowNotify = 0 1 (0=No, 1=Yes) HighShutdown = 0 1 (0=No, 1=Yes) ⁽¹⁾ LowShutdown = 0 1 (0=No, 1=Yes) ⁽¹⁾
Examples	#> setTemp Unit=C
Comments	⁽¹⁾ : Writing enabled only if the notification is enabled

6.4.9.5 “getHum”

Purpose	To read a humidity setting
Syntax	getHum [option1] [option2] ... options : HighThreshold LowThreshold Hysteresis Offset

	HighNotify LowNotify HighShutdown LowShutdown
Examples	#> getHum Offset
Comments	

6.4.9.6 “setHum”

Purpose	To modify a humidity setting
Syntax	setHum [option1] [option2] ... options : HighThreshold = xx LowThreshold =xx Hysteresis = xx (0..5) Offset = xx (-5..5) HighNotify = 0 1 (0=No, 1=Yes) LowNotify = 0 1 (0=No, 1=Yes) HighShutdown = 0 1 (0=No, 1=Yes) ⁽¹⁾ LowShutdown = 0 1 (0=No, 1=Yes) ⁽¹⁾
Examples	#> setHum HighNotify=0
Comments	⁽¹⁾ : Writing enabled only if the notification is enabled

6.4.9.7 “getInput1” or “getInput2”

Purpose	To read input setting
Syntax	getInput1 [option1] [option2] ... options : iName State[0].Description State[0].Notify State[0].Shutdown State[1].Description State[1].Notify State[1].Shutdown
Examples	#> getInput1 iName
Comments	

6.4.9.8 “setInput1” or “setInput2”

Purpose	To modify input setting
Syntax	setInput1 [option1] [option2] ... options :

Network Management Card (Network-MS) User Manual

	iName = "xx.xx" State[0].Description = "xx.xx" State[0].Notify = 0 1 (0=No, 1=Yes) State[0].Shutdown = 0 1 (0=No, 1=Yes) State[1].Description = "xx.xx" State[1].Notify = 0 1 (0=No, 1=Yes) ⁽¹⁾ State[1].Shutdown = 0 1 (0=No, 1=Yes) ⁽¹⁾
Examples	#> setInput1 State[0].Label = "Door open" State[0].Notify = 1
Comments	⁽¹⁾ : Writing enabled only if the notification is enabled

6.5 Constraints/Limitations

1. It is not possible to open sessions with different protocols (see table below).
2. The maximum number of sessions opened at same time is 5.
3. Email recipients can not be configured through Telnet/SSH/CLI.

Table of compatibility:

	TELNET & MENU	TELNET & CLI	SSH & MENU	SSH & CLI
TELNET & MENU	<input type="checkbox"/>			
TELNET & CLI	<input type="checkbox"/>	<input type="checkbox"/>		
SSH & MENU	<input type="checkbox"/>	<input type="checkbox"/>	<input type="checkbox"/>	
SSH & CLI	<input type="checkbox"/>	<input type="checkbox"/>	<input type="checkbox"/>	<input type="checkbox"/>

7 Configuration via RS232

- Use the cord supplied with the card (only with reference 34003918 or CAB-00010 or 720-C2270-00).

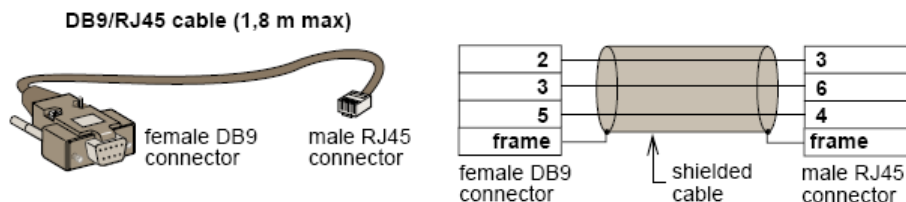

- Connect the card to a computer equipped with a hyperterminal type emulator. The serial link must be set at 9600 baud, 8 bits, no parity, 1 stop bit, and without flow control.
- Check that UPS power is on.
- Enter admin as password (not modifiable).
- The menu is in English only.

```
-----  
EATON  
NETWORK MANAGEMENT CARD  
-----  
1 : Reset  
2 : Network configuration  
3 : Set Login Password to Default  
4 : Return to Default Configuration  
0 : Exit  
-----
```

7.1 Choice 1: Restart / Reset

Use this function to restart the card from the boot
This is equivalent to a restart of the electrical power supply.

```
-----  
Reset  
-----  
1 : Restart the card from the boot  
0 : Exit  
-----
```

7.2 Choice 2: Network Configuration

Use this function to access network settings.

```
-----  
Network settings  
-----  
1 : Read Network settings  
2 : Modify Network settings  
3 : Set Ethernet speed  
0 : Exit  
-----
```

7.2.1 Choice 1: Read IPv4&IPv6 Network settings

Enables reading of the card's routine settings

```
Network configuration :  
MAC address : 00:20:85:FD:1C:07  
Mode : Static IP  
IP address : xxx.xxx.xxx.xxx  
Subnet mask : xxx.xxx.xxx.xxx  
Gateway : xxx.xxx.xxx.xxx  
Link Local IPv6 address : xxxx::xxxx:xxxx:xxxx:xxxx /xx  
Global IPv6 address : xxxx:xxxx:xxxx:xxxx:xxxx:xxxx:xxxx:xxxx /xx  
Global IPv6 address : xxxx:xxxx:xxxx:xxxx:xxxx:xxxx:xxxx:xxxx /xx
```

7.2.2 Choice 2: Modify IPv4 Network settings

Enables the modification of network parameters

For each of the following questions, you can press <Return> to select the value shown in braces, or you can enter a new value.
Should this target obtain IP settings from the network?[N]
Static IP address [xxx.xxx.xxx.xxx]?
Subnet Mask [xxx.xxx.xxx.xxx]?
Gateway IP address [xxx.xxx.xxx.xxx]?
Wait during your new configuration is saved ...
Reset the card to take into account the new configuration.

In DHCP mode, the card can receive the following parameters according to the DHCP server settings

- IPv4 address
- Subnet Mask
- IPv4 Gateway address
- Primary DNS server
- Secondary DNS server

The card must be [restarted](#) in order for the new parameters to be taken into account.

7.2.3 Choice 3: Set Ethernet speed

Enables the modification of the network speed

Set the Ethernet speed : [1 : Automatic, 2 : 10 MBit]
1
New Ethernet speed : Automatic
Wait during the new setting is saved ...
Reset the card to take into account the new configuration.

The card must be [restarted](#) in order for the new parameters to be taken into account.

7.3 Choice 3: Lost password / Set Login Password to Default

In the even the login or password is lost, choice 3 enables the return to the default password:

```
-----  
EATON  
NETWORK MANAGEMENT CARD  
-----  
1 : Reset  
2 : Network configuration  
3 : Set Login Password to Default  
4 : Return to Default Configuration  
0 : Exit  
-----  
Wait during Login Password return to default ...
```

Wait for the confirmation message.

```
Login & Password have been successfully set.
```

The card is now accessible via the Web with the password admin.

The card must be [restarted](#) in order for the new parameters to be taken into account.

7.4 Choice 4: Return to Default Configuration

Enables restoration of the [default configuration](#) of all the card's parameters

```
-----  
EATON  
NETWORK MANAGEMENT CARD  
-----  
1 : Reset  
2 : Network configuration  
3 : Set Login Password to Default  
4 : Return to Default Configuration  
0 : Exit  
-----  
Wait during configuration returns to default ...
```

Wait for the confirmation message.

```
Configuration has been set to default one.  
You must Reset the card.
```

The card must be [restarted](#) in order for the new parameters to be taken into account.

8 Appendix

8.1 Tables of alarms and events

8.1.1 Table of alarms

List of time dated alarms

Alarm on	Alarm off
Battery fuse blown	Battery fuse OK
No Battery	Battery present
Battery temperature fault	Battery temperature OK
Battery charger fault	Battery charger OK
Battery fault	Battery OK
MAX charger voltage fault	Charger voltage OK
MIN charger voltage fault	Charger voltage OK
Charger temperature fault	Charger temperature OK
Rectifier fault	Rectifier OK
Chopper fault	Chopper OK
Normal AC frequency out of tolerance	Normal AC frequency OK
Normal AC fuses blown	Normal AC fuses OK
Normal AC module fault	Normal AC module OK
Normal AC voltage out of tolerance	Normal AC voltage OK
Normal AC NOK	Normal AC OK
Site wiring fault	Site wiring OK
Bypass AC frequency out of tolerance	Bypass AC frequency OK
Bypass AC phase out of tolerance	Bypass AC phase OK
Bypass AC voltage out of tolerance	Bypass AC voltage OK
Automatic Bypass fault	Automatic Bypass OK
Automatic Bypass overload	Automatic Bypass load OK
Automatic Bypass over temperature	Automatic Bypass temperature OK
Automatic Bypass thermal overload	Automatic Bypass load OK
Automatic Bypass switch (Q4S) open	Automatic Bypass switch (Q4S) closed
Normal AC switch (Q1) open	Normal AC switch (Q1) closed
Battery switch (QF1) open	Battery switch (QF1) closed
Manual Bypass switch (Q3BP) closed	Manual Bypass switch (Q3BP) open
UPS on manual bypass	
Output switch (Q5N) open	Output switch (Q5N) closed
Single wave load fault	Load OK
Negative DC bus too high	Negative DC bus OK

Network Management Card (Network-MS) User Manual

Positive DC bus too high	Positive DC bus OK
Negative DC bus too low	Negative DC bus OK
Positive DC bus too low	Positive DC bus OK
Inverter limitation	Inverter end of limitation
Inverter fuses blown	Input fuses OK
Inverter fault	Inverter OK
Inverter overload	Inverter load OK
Inverter over temperature	Inverter temperature OK
Inverter short circuit	Inverter OK
Inverter thermal overload	Inverter load OK
Load not protected - On Automatic Bypass	Load protected - Return from Bypass
Load short circuit	Load OK
Load not powered	Load powered
Protection Lost	Protection OK
Emergency button ON	Emergency button OFF
Fan fault	Fan OK
Redundancy Lost	Redundancy OK
Low battery	Battery OK
UPS communication failed	UPS communication restored
UPS data base not available	UPS data base OK
UPS on battery	UPS on normal AC
UPS internal fault	UPS OK
UPS overload	UPS returns to normal load
UPS overtemperature	UPS temperature OK
Imminent UPS shutoff	UPS OK
<Sensor name>: Temperature is above high threshold xx °C	<Sensor name>: Temperature is in normal range
<Sensor name>: Humidity is above high threshold xx %	<Sensor name>: Humidity is in normal range
<Sensor name>: Temperature is below low threshold xx °C	<Sensor name>: Temperature is in normal range
<Sensor name>: Humidity is below low threshold xx %	<Sensor name>: Humidity is in normal range
<Sensor name>: <Input #1 label> <when closed label>	<Sensor name>: <Input #1 label> <when closed label>
<Sensor name>: <Input #1 label> <when open label>	<Sensor name>: <Input #1 label> <when open label>
<Sensor name>: <Input #2 label> <when closed label>	<Sensor name>: <Input #2 label> <when closed label>
<Sensor name>: <Input #2 label> <when open label>	<Sensor name>: <Input #2 label> <when open label>

Network Management Card (Network-MS) User Manual

If the UPS is modular UPS, for each module:

Battery fuse blown

No Battery
Battery temperature fault
Battery charger fault
Low battery
Charger temperature fault
MAX charger voltage fault
MIN charger voltage fault
Chopper fault
Normal AC fuses blown
Normal AC module fault
Inverter fuses blown
Inverter fault
Inverter short circuit
Load short circuit
Rectifier fuse blown
Rectifier fault
DC bus unbalanced
Emergency button ON
Load not powered
UPS internal fault
Battery fault
Imminent UPS shutoff
Normal AC frequency out of tolerance
Normal AC voltage out of tolerance
Normal AC switch (Q1) open
Site wiring fault
Automatic Bypass switch (Q4S) open
Bypass AC frequency out of tolerance
Automatic Bypass fault
Automatic Bypass overload
Automatic Bypass overtemperature
Automatic Bypass thermal overload
Bypass AC phase out of tolerance
Bypass AC voltage out of tolerance
Load not protected - On Automatic Bypass
Battery switch (QF1) open
Manual Bypass switch (Q3BP) closed
UPS on manual bypass

Battery fuse OK

Battery present
Battery temperature OK
Battery charger OK
Battery OK
Charger temperature OK
Charger voltage OK
Charger voltage OK
Chopper OK
Normal AC fuses OK
Normal AC module OK
Input fuses OK
Inverter OK
Inverter OK
Load OK
Rectifier OK
Rectifier OK
Load OK
Emergency button OFF
Load powered
UPS OK
Battery OK
UPS OK
Normal AC frequency OK
Normal AC voltage OK
Normal AC switch (Q1) closed
Site wiring OK
Automatic Bypass switch (Q4S) closed
Bypass AC frequency OK
Automatic Bypass OK
Automatic Bypass load OK
Automatic Bypass temperature OK
Automatic Bypass load OK
Bypass AC phase OK
Bypass AC voltage OK
Load protected - Return from Bypass
Battery switch (QF1) closed
Manual Bypass switch (Q3BP) open

Network Management Card (Network-MS) User Manual

Inverter limitation
Inverter overload
Inverter over temperature
Inverter thermal overload
Negative DC bus too high
Positive DC bus too high
Negative DC bus too low
Positive DC bus too low
Output switch (Q5N) open
Normal AC NOK
UPS on battery
UPS overload
UPS over temperature
Fan fault
UPS communication failed

Inverter end of limitation
Inverter load OK
Inverter temperature OK
Inverter load OK
Negative DC bus OK
Positive DC bus OK
Negative DC bus OK
Positive DC bus OK
Output switch (Q5N) closed
Normal AC OK
UPS on normal AC
UPS returns to normal load
UPS temperature OK
Fan OK
UPS communication restored

8.1.2 Table of UPS events

List of time dated informations

Alarm on

Battery fuse blown
Battery temperature fault
No Battery
Battery charger fault
Charger temperature fault
MAX charger voltage fault
MIN charger voltage fault
End of Warranty
End of battery life
End of life of the wearing parts
Outlet 1 open
Outlet 2 open
Chopper fault
Normal AC switch (Q1) open
Normal AC frequency out of tolerance
Normal AC fuses blown
Normal AC module fault
Normal AC voltage out of tolerance
Site wiring fault

Alarm off

Battery fuse OK
Battery temperature OK
Battery present
Battery charger OK
Charger temperature OK
Charger voltage OK
Charger voltage OK
LCM message OK
LCM message OK
LCM message OK
Outlet 1 closed
Outlet 2 closed
Chopper OK
Normal AC switch (Q1) closed
Normal AC frequency OK
Normal AC fuses OK
Normal AC module OK
Normal AC voltage OK
Site wiring OK

Network Management Card (Network-MS) User Manual

Automatic Bypass switch (Q4S) open	Automatic Bypass switch (Q4S) closed
Bypass AC frequency out of tolerance	Bypass AC frequency OK
Automatic Bypass fault	Automatic Bypass OK
Automatic Bypass overload	Automatic Bypass load OK
Automatic Bypass over temperature	Automatic Bypass temperature OK
Bypass AC phase out of tolerance	Bypass AC phase OK
Automatic Bypass thermal overload	Automatic Bypass load OK
Load not protected - On Automatic Bypass	Load protected - Return from Bypass
Bypass AC voltage out of tolerance	Bypass AC voltage OK
Battery switch (QF1) open	Battery switch (QF1) closed
Manual Bypass switch (Q3BP) closed	Manual Bypass switch (Q3BP) open
UPS on manual bypass	
Inverter limitation	Inverter end of limitation
Inverter fuses blown	Input fuses OK
Inverter fault	Inverter OK
Inverter overload	Inverter load OK
Inverter overtemperature	Inverter temperature OK
Inverter short circuit	Inverter OK
Inverter thermal overload	Inverter load OK
Output switch (Q5N) open	Output switch (Q5N) closed
Load short circuit	Load OK
Single wave load fault	Load OK
Negative DC bus too high	Negative DC bus OK
Positive DC bus too high	Positive DC bus OK
Rectifier fault	Rectifier OK
Negative DC bus too low	Negative DC bus OK
Positive DC bus too low	Positive DC bus OK
Protection Lost	Protection OK
Redundancy Lost	Redundancy OK
Normal AC NOK	Normal AC OK
Low battery	Battery OK
UPS communication failed	UPS communication restored
UPS data base not available	UPS data base OK
UPS on battery	UPS on normal AC
Emergency button ON	Emergency button OFF
Fan fault	Fan OK
Load not powered	Load powered
UPS internal fault	UPS OK
Battery fault	Battery OK
UPS overload	UPS returns to normal load
UPS over temperature	UPS temperature OK

Network Management Card (Network-MS) User Manual

Imminent UPS shutoff

< Sensor Name> : Temperature is above high threshold <xx> (°C) or (°F)

< Sensor Name> : Humidity is above high threshold <xx> (%)

< Sensor Name> : Temperature is below low threshold <xx> °C or (°F)

< Sensor Name> : Humidity is below high threshold <xx> (%)

<Sensor name>: <Input #1 label> <when closed label>

<Sensor name>: <Input #1 label> <when open label>

<Sensor name>: <Input #2 label> <when closed label>

<Sensor name>: <Input #2 label> <when open label>>

UPS OK

<Sensor Name> : Temperature is in normal range

<Sensor Name> : Temperature is in normal range

<Sensor Name> : Temperature is in normal range

<Sensor Name> : Temperature is in normal range

Network Management Card (Network-MS)

User Manual

8.1.3 Table of system alarms

Network Management Card startup
Send test mail SUCCESS
Send test mail ERROR
Send mail to <recipient> ERROR
<Sensor name> Communication failure
<Sensor name> Communication restored
Firmware upgraded
Connected NSM list Full, last connection refused
sendTrap()-> Unable to resolve hostname <hostname>
SNMP Send Trap # <num> failure to <hostname>
Time changed by user with yyyy/mm/dd hh:mm:ss
Time synchronized by NSM or EPM with yyyy/mm/dd hh:mm:ss

8.2 SNMP objects

8.2.1 IETF MIB

The Card implements the full IETF standard UPS MIB (RFC 1628), including the IETF alarm table and traps. Visit <http://tools.ietf.org> for a description of the MIB. The UPS MIB access path is 1.3.6.1.2.1.33

8.2.2 EATON Pulsar MIB (ex MGE)

This section contains an overview of MIB definitions for each of the MIB files:

Eaton Pulsar MIB (MGE MIB)

Eaton Pulsar MIB (MGE MIB) for environmental sensors

The NMC implements the reduced Eaton Pulsar MIB (MGE MIB), only the objects listed in the following tables are managed. The entire MIB description is available at <http://download.mgeops.com>

The Eaton Pulsar MIB access path is 1.3.6.1.4.1.705.1.

MIB object	SNMP Format	Add.path
upsmgIdentFamilyName	String	{1.1.0}
upsmgIdentModelName	String	{1.2.0}
upsmgIdentFirmwareVersion	String	{1.4.0}
upsmgIdentSerialNumber	String	{1.7.0}
upsmgConfigLowBatteryTime	seconds	{4.7.0}
upsmgConfigLowBatteryLevel	%	{4.8.0}
upsmgConfigAutoRestart	1(yes) 2(no)	{4.9.0}
upsmgConfigVARating	VA	{4.12.0}
upsmgBatteryRemainingTime	seconds	{5.1.0}
upsmgBatteryLevel	%	{5.2.0}
upsmgBatteryVoltage	deciVolts	{5.5.0}
upsmgBatteryCurrent	deciAmps	{5.6.0}
upsmgBatteryFaultBattery	1(yes) 2(no)	{5.9.0}
upsmgBatteryReplacement	1(yes) 2(no)	{5.11.0}
upsmgBatteryLowBattery	1(yes) 2(no)	{5.14.0}
upsmgBatteryChargerFault	1(yes) 2(no)	{5.15.0}
upsmgBatteryLowCondition	1(yes) 2(no)	{5.16.0}
upsmgInputPhaseNum		{6.1.0}
mginputVoltage_1	DeciVolts	{6.2.1.2.1.0}
mginputVoltage_2	DeciVolts	{6.2.1.2.2.0}
mginputVoltage_3	DeciVolts	{6.2.1.2.3.0}

Network Management Card (Network-MS) User Manual

mginputFrequency_1	DeciHz	{6.2.1.3.1.0}
mginputFrequency_2	DeciHz	{6.2.1.3.2.0}
mginputFrequency_3	DeciHz	{6.2.1.3.3.0}
mginputMinimumVoltage		{6.2.1.4.0}
mginputMaximumVoltage		{6.2.1.5.0}
mginputCurrent_1	DeciAmps	{6.2.1.6.1.0}
mginputCurrent_2	DeciAmps	{6.2.1.6.2.0}
mginputCurrent_3	DeciAmps	{6.2.1.6.3.0}
upsmgInputBadStatus		{6.3.0}
upsmgInputLineFailCause		{6.4.0}
upsmgOutputPhaseNum		{7.1.0}
mgoutputPhaseIndex_1		{7.2.1.1.1.0}
mgoutputPhaseIndex_2		{7.2.1.1.2.0}
mgoutputPhaseIndex_3		{7.2.1.1.3.0}
mgoutputVoltage_1	deciVolts	{7.2.1.2.1.0}
mgoutputVoltage_2	deciVolts	{7.2.1.2.2.0}
mgoutputVoltage_3	deciVolts	{7.2.1.2.3.0}
mgoutputFrequency_1	deciHz	{7.2.1.3.1.0}
mgoutputFrequency_2	deciHz	{7.2.1.3.2.0}
mgoutputFrequency_3	deciHz	{7.2.1.3.3.0}
mgoutputLoadPerPhase_1	%	{7.2.1.4.1.0}
mgoutputLoadPerPhase_2	%	{7.2.1.4.2.0}
mgoutputLoadPerPhase_3	%	{7.2.1.4.3.0}
mgoutputCurrent_1	deciAmps	{7.2.1.5.1.0}
mgoutputCurrent_2	deciAmps	{7.2.1.5.2.0}
mgoutputCurrent_3	deciAmps	{7.2.1.5.3.0}
upsmgOutputOnBattery	1(yes) 2(no)	{7.3.0}
upsmgOutputOnByPass	1(yes) 2(no)	{7.4.0}
upsmgOutputUtilityOff	1(yes) 2(no)	{7.7.0}
upsmgOutputInverterOff	1(yes) 2(no)	{7.9.0}
upsmgOutputOverLoad	1(yes) 2(no)	{7.10.0}
upsmgOutputOverTemp	1(yes) 2(no)	{7.11.0}
upsmgAgentIpAddress		{12.1.0}
upsmgAgentSubnetMask		{12.2.0}
upsmgAgentDefGateway		{12.3.0}
upsmgAgentType		{12.6.0}
upsmgAgentMibVersion		{12.11.0}
upsmgAgentFirmwareVersion		{12.12.0}
upsmgAgentCommUPS	1(yes) 2(no)	{12.13.0}

Network Management Card (Network-MS)

User Manual

Network Management Card (Network-MS)

User Manual

This table lists objects that are managed if there is an optional Sensor / Environmental Monitoring Probe (EMP) installed. The Eaton Pulsar MIB access path is 1.3.6.1.4.1.705.1.

upsmgEnvironAmbientTemp	0.1 degré	{8.1.0}
upsmgEnvironAmbientHumidity	0.1 %	{8.2.0}
upsmgEnvironmentNum		{8.6.0}
upsmgEnvironmentIndex		{8.7.1.1.1}
upsmgEnvironmentComFailure	1(yes) 2(no)	{8.7.1.2.1}
upsmgEnvironmentTemperature	0.1 degré	{8.7.1.3.1}
upsmgEnvironmentTemperatureLow	1(yes) 2(no)	{8.7.1.4.1}
upsmgEnvironmentTemperatureHigh	1(yes) 2(no)	{8.7.1.5.1}
upsmgEnvironmentHumidity	0.1 %	{8.7.1.6.1}
upsmgEnvironmentHumidityLow	1(yes) 2(no)	{8.7.1.7.1}
upsmgEnvironmentHumidityHigh	1(yes) 2(no)	{8.7.1.8.1}
upsmgEnvironmentInput1State	closed(1), open(2)	{8.7.1.9.1}
upsmgEnvironmentInput2State	closed(1), open(2)	{8.7.1.10.1}

8.2.3 TRAPS table: (1.3.6.1.4.1.705.1.11)

SNMP traps are sent when alarms appears and disappears.

Level 1: informational, 2: major, 3: critical

MIB TRAP	Trap #	Level
upsmgBatteryFault	Trap 1	Level 3
upsmgBatteryOK	Trap 2	Level 1
upsmgAtLowBattery	Trap 5	Level 3
upsmgFromLowBattery	Trap 6	Level 1
upsmgChargerFault	Trap 7	Level 3
upsmgChargerOK	Trap 8	Level 1
upsmgOnBattery	Trap 11	Level 2
upsmgReturnFromBattery	Trap 12	Level 1
upsmgOnByPass	Trap 13	Level 2
upsmgReturnFromByPass	Trap 14	Level 1
upsmgUtilityFailure	Trap 17	Level 2
upsmgUtilityRestored	Trap 18	Level 1
upsmgOverLoad	Trap 21	Level 3
upsmgLoadOK	Trap 22	Level 1
upsmgOverTemperature	Trap 23	Level 3
upsmgTemperatureOK	Trap 24	Level 1
upsmgOffToStart	Trap 29	Level 2
upsmgOffInProgress	Trap 31	Level 3
upsmgCommunicationFailure	Trap 37	Level 3
upsmgCommunicationRestored	Trap 38	Level 1
upsRedundancyLost	Trap 65	Level 2
upsRedundancyOK	Trap 66	Level 1
upsProtectionLost	Trap 67	Level 2
upsProtectionOK	Trap 68	Level 1

If the Environment Sensor is detected, the following information is managed:

upsEnvironmentComFailure	Trap 53	Level 2
upsEnvironmentComOK	Trap 54	Level 2
upsEnvironmentTemperatureLow	Trap 55	Level 2
upsEnvironmentTemperatureHigh	Trap 56	Level 2
upsEnvironmentTemperatureOK	Trap 57	Level 2
upsEnvironmentHumidityLow	Trap 58	Level 2
upsEnvironmentHumidityHigh	Trap 59	Level 2

Network Management Card (Network-MS) User Manual

upsEnvironmentHumidityOK	Trap 60	Level 2
upsEnvironmentInput1Closed	Trap 61	Level 2
upsEnvironmentInput1Open	Trap 62	Level 2
upsEnvironmentInput2Open	Trap 64	Level 2
upsEnvironmentInput2Closed	Trap 63	Level 2

The level is used to select traps to be sent to the supervisor. This adjustment is available from the “Notified applications” page

8.2.4 EATON Powerware MIB

The Card implements the full Eaton Powerware MIB (PowerMIB), including alarm tables. The Eaton traps are sent. The Eaton Powerware MIB access path is 1.3.6.1.4.1.534.

Table is an abbreviated list of objects from the PowerMIB. The UPS output/load segment controls objects and the entire MIB description is available at <http://powerquality.eaton.com/Support/SoftwareDrivers>.

MIB Object	SNMP Format	Add.path
xupsIdentManufacturer	String	{1.1.0}
xupsIdentModel	String	{1.2.0}
xupsIdentSoftwareVersion	String	{1.3.0}
xupsIdentOemCode	Integer	{1.4.0}
xupsBatTimeRemaining	Seconds	{2.1.0}
xupsBatVoltage	Volts DC	{2.2.0}
xupsBatCurrent	Amps DC	{2.3.0}
xupsBatCapacity	Percent	{2.4.0}
xupsBatteryAbmStatus	Integer	{2.5.0}
xupsBatteryLastReplacedDate	String	{2.6.0}
xupsInputFrequency	0.1 Hertz	{3.1.0}
xupsInputLineBads	Integer	{3.2.0}
xupsInputNumPhases	Integer	{3.3.0}
xupsInputTable		{3.4.0}
xupsInputPhase	Integer	{3.4.1.1.x}
xupsInputVoltage	RMS Volts	{3.4.1.2.x}
xupsInputCurrent	RMS Amps	{3.4.1.3.x}
xupsInputWatts	Watts	{3.4.1.4.x}
xupsInputSource	Integer	{3.5.0}
xupsDualInputStatus	Integer	{3.6.0}

Network Management Card (Network-MS) User Manual

xupsSecondaryInputWatch	Integer	{3.7.0}
xupsOutputLoad	Percent	{4.1.0}
xupsOutputFrequency	0.1 Hertz	{4.2.0}
xupsOutputNumPhases	Integer	{4.3.0}
xupsOutputTable		{4.4.0}
xupsOutputPhase	Integer	{4.4.1.1.x}
xupsOutputVoltage	RMS Volts	{4.4.1.2.x}
xupsOutputCurrent	RMS Amps	{4.4.1.3.x}
xupsOutputWatts	Watts	{4.4.1.4.x}
xupsOutputSource	Integer	{4.5.0}
xupsBypassFrequency	0.1 Hertz	{5.1.0}
xupsBypassNumPhases	Integer	{5.2.0}
xupsBypassTable		{5.3.0}
xupsBypassPhase	Integer	{5.3.1.1.x}
xupsBypassVoltage	RMS Volts	{5.3.1.2.x}
xupsEnvAmbientTemp	Degrees C	{6.1.0}
xupsEnvAmbientLowerLimit	Degrees C	{6.2.0}
xupsEnvAmbientUpperLimit	Degrees C	{6.3.0}
xupsEnvAmbientHumidity	Percent	{6.4.0}
xupsEnvRemoteTemp	Degrees C	{6.5.0}
xupsEnvRemoteHumidity	Percent	{6.6.0}
xupsEnvNumContacts	Integer	{6.7.0}
xupsContactSenseTable	table	{6.8.0}
xupsContactIndex	Integer	{6.8.1.1.x}
xupsContactType	Integer	{6.8.1.2.x}
xupsContactState	Integer	{6.8.1.3.x}
xupsContactDescr	String	{6.8.1.4.x}
xupsEnvRemoteTempLowerLimit	Degrees C	{6.9.0}
xupsEnvRemoteTempUpperLimit	Degrees C	{6.10.0}
xupsEnvRemoteHumidityLowerLimit	Percent	{6.11.0}
xupsEnvRemoteHumidityUpperLimit	Percent	{6.12.0}
xupsAlarmTable	table	{7.2.0}
xupsAlarmID		{7.2.1.1.x}
xupsAlarmDescr		{7.2.1.2.x}
xupsAlarmTime		{7.2.1.3.x}

Network Management Card (Network-MS)

User Manual

xupsOnBattery		{7.3.0}
xupsLowBattery		{7.4.0}
xupsUtilityPowerRestored		{7.5.0}
xupsReturnFromLowBattery		{7.6.0}
upsOutputOverload		{7.7.0}
xupsInternalFailure		{7.8.0}
xupsBatteryDischarged		{7.9.0}
xupsInverterFailure		{7.10.0}
xupsOnBypass		{7.11.0}
xupsBypassNotAvailable		{7.12.0}
xupsOutputOff		{7.13.0}
xupsInputFailure		{7.14.0}
xupsBuildingAlarm		{7.15.0}
xupsShutdownImminent		{7.16.0}
xupsOnInverter		{7.17.0}
xupsBreakerOpen		{7.20.0}
xupsAlarmBatteryBad		{7.23.0}
xupsOutputOffAsRequested		{7.24.0}
xupsDiagnosticTestFailed		{7.25.0}
xupsCommunicationsLost		{7.26.0}
xupsUpsShutdownPending		{7.27.0}
xupsAlarmTestInProgress		{7.28.0}
xupsAmbientTempBad		{7.29.0}
xupsLossOfRedundancy		{7.30.0}
xupsAlarmTempBad		{7.31.0}
xupsAlarmChargerFailed		{7.32.0}
xupsAlarmFanFailure		{7.33.0}
xupsAlarmFuseFailure		{7.34.0}
xupsPowerSwitchBad		{7.35.0}
xupsModuleFailure		{7.36.0}
xupsOnAlternatePowerSource		{7.37.0}
xupsAltPowerNotAvailable		{7.38.0}
xupsNoticeCondition		{7.39.0}
xupsRemoteTempBad		{7.40.0}
xupsRemoteHumidityBad		{7.41.0}
xupsAlarmOutputBad		{7.42.0}
xupsAlarmAwaitingPower		{7.43.0}
xupsOnMaintenanceBypass		{7.44.0}

Network Management Card (Network-MS) User Manual

xupsTestBatteryStatus	Integer	{8.2.0}
xupsLastGeneralTest	Integer	{8.3.0}
xupsLastGeneralTestResult	Integer	{8.4.0}
xupsConfigOutputVoltage	RMS Volts	{10.1.0}
xupsConfigInputVoltage	RMS Volts	{10.2.0}
xupsConfigOutputWatts	Watts	{10.3.0}
xupsConfigOutputFreq	0.1 Hertz	{10.4.0}
xupsConfigDateAndTime	String	{10.5.0}
xupsConfigLowOutputVoltageLimit RMS Volts		{10.6.0}
xupsConfigHighOutputVoltageLimit RMS Volts		{10.7.0}
xupsConfigInstallDate	String	{10.8.0}
xupsTopologyType	Integer	{13.1.0}
xupsTopoMachineCode	Integer	{13.2.0}
xupsTopoUnitNumber	Integer	{13.3.0}
xupsTopoPowerStrategy	Integer	{13.4.0}

8.3 Authentication Configuration Example

8.3.1 RADIUS

A IP card is running with the 166.99.224.96 IP address.

A freeradius (version 1.1.7-r0.0.2) is running (IP address:166.99.224.129, port :1812), with the following configuration:

- **clients.conf file:** allows NAS (NMC card) with an address in the 166.99.224/8 network to send requests to the server (shared secret between the server and the NMC cards: eaton123)

```
client 166.99.224.0/8{
  secret      = eaton123
  shortname   = nmc
  require_message_authenticator = no
}
```

- **users.conf file:** allows (with Service-Type attribute) the access to the NMC cards as an administrator for the user:
 - name: "admin",
 - password "myPassword "

Network Management Card (Network-MS) User Manual

```
admin Cleartext-Password := "myPassword"
Service-Type = Administrative-User
```

The following RADIUS configuration must be apply(value of the masked field secret: *eaton123*):

Enable Configuration:	Enabled ▾
Primary/Secondary:	Primary ▾
Radius Server:	166.99.224.129
Secret:	*****
NAS IP Address:	166.99.224.96 ▾
Auth. Port:	1812
Time Out:	10
Retry Number:	3

Save

Back

8.3.2 LDAP

A IP card is running with the 166.99.224.96 IP address.

An Active Directory server is running (IP address: 10.130.32.6, port : 389), with the following configuration:

- Base Name : **DC=mbdevd,DC=ch,DC=etn,DC=com**
- User with the necessary rights to search information about users and groups:
 - Distinguish Name : **CN=searchUser,CN=Users,DC=mbdevd,DC=ch,DC=etn,DC=com**
 - Password: **eaton**
- NMC Card User:
 - Distinguish Name: **CN=UPSUser,CN=Users,DC=mbdevd,DC=ch,DC=etn,DC=com**
 - LDAP Class Type: **user**
 - sAMAccountName Attribute: **UPSAdmin**
 - Password: **eaton**
- Group managing permissions to access to the NMC cards
 - Distinguish Name : **CN=UPSAdmins,OU=eUPSOU,DC=mbdevd,DC=ch,DC=etn,DC=com**
 - sAMAccountName Attribute: **UPSAdministrators**
 - Attribute member : **CN=UPSAdminUser,CN=Users,DC=mbdevd,DC=ch,DC=etn,DC=com**

In order to allow the Web access for the user:

- Login identifier: **UPSAdmin**

Network Management Card (Network-MS)

User Manual

- Password: **eaton**

The following LDAP configuration must be apply(value of the masked field "Search User Password": *eaton*):

Authentication Mechanism:	Simple <input type="button" value="v"/>
User Search Bind:	By Accredited User <input type="button" value="v"/>
Search User:	CN=searchUser,CN=Users,DC=mbdevd,DC=ch,DC=etn,DC=
Search User Password:
User Base DN:	CN=Users,DC=mbdevd,DC=ch,DC=etn,DC=com
User Object:	user
User Attribute:	sAMAccountName
Authorization Mode:	By Group <input type="button" value="v"/>
UPS Group Base DN:	OU=eUPSOU,DC=mbdevd,DC=ch,DC=etn,DC=com
Group Name Attribute:	sAMAccountName
User Name Attribute:	member

	Priority	LDAP Server Name or IP Address	Port
<input checked="" type="radio"/>	PRIMARY	10.130.32.6	389
<input type="radio"/>	SECONDARY		389

Select the LDAP Server to be modified.

9 Glossary

Bootp:

Protocol based on UDP used to allocate an IP address corresponding to an Ethernet card during the startup phase. Defined by the RCF 951

CLI Command line interface

This interface allows direct access to the individual configuration parameters.

Community name:

Access key to access SNMP agent information

DHCP Dynamic Host Configuration Protocol

This IETF protocol enables remote, automatic, self-configuration of the IP addresses of a workstation.

DN Distinguished Name

An LDAP object is referenced by its distinguished name (DN). A DN is a sequence of relative distinguished names (RDN) connected by commas.

DNS Domain Name Service

The DNS protocol ensure correspondence between the name of a machine and its IP address

Gateway

Interconnection equipment between networks with different conventions, to enable communication between them

HTML HyperText Markup Language

Language used to describe hypertext pages on the web.

HTTPS

Secure version of HTTP, the communication protocol of the World Wide Web. It was invented by Netscape Communications Corporation to provide authentication and encrypted communication and is used in electronic commerce.

IPP Intelligent Power Protector

Protection software installed on a PC or server to protect it

IPP SHUTDOWN CENTER

Communication software installed on a PC connected to the UPS to supervise it and communicate with Intelligent Power Protector to insure power protection on servers

Network Management Card (Network-MS) User Manual

MIB Management Informatique Base

Group of software commands to control and administrate a device through the network. Each type of device (server, hub, PC, UPS, etc.) has its own MIB

NMC Network Management Card

Communication cards to supervise UPS and communicate with Intelligent Power Protector to insure power protection on servers

NMS Network Management Station (SNMP)

The dedicated PC or workstation is used on the company's networks to administrate all devices connected to the network. Data are transmitted using the SNMP protocol. Popular NMS systems include HP OpenView, IBM Tivoli, CA Unicenter, etc.

IPP: Intelligent Power Protector

Protection software installed on a PC or server to protect it

NTP Network Time Protocol

Network protocol that synchronizes the time on several machines.

Programmable outlet (controlled outlet):

Outlet that can be remote-switched on or off. UM-Client components enable management of such outlets.

RDN Relative Distinguished Names

A RDN is an LDAP attribute with an associated value in the form attribute=value.

REBOOT: To restart a system after an interruption.

- To perform an obstacle-free "reboot", it is essential that the system is correctly and carefully shut down beforehand.
- The reboot is usually automatic if the computer is re-supplied with electricity (from the utility or from the UPS).

RFC

Request for Comments. All documents defining internal Internet operation.

SNMP Simple Network Management Protocol

Protocol used to remote-supervise, administrate and control devices connected to a company network.

SMTP Simple Mail Transfer Protocol

Enables message transfer between e-mail servers or between the client and its server. It is based on the server's port 25. It is described in RFC 821

SSH Secure SHell

Network Management Card (Network-MS) User Manual

Telnet is not a secure protocol, but it is possible to secure the connection using SSH

SSL (Secure Sockets Layers) is a protocol developed by Netscape Communications Corporation for securing data transmission in commercial transactions on the Internet. Using public-key cryptography, SSL provides server authentication, data encryption, and data integrity for client/server communications

Subnet mask

Mask of bits used to identify and differentiate the network address and the equipment address in an IP address. Normally, the mask is automatically determined by the class of address, which defines in a unique manner the network part/equipment part division of the IP address.

- Class A: internet address: 255.0.0.0.
- Class B: internet address: 255.255.0.0.
- Class C: internet address: 255.255.255.0.

TELNET TERminal over NETwork

Telnet is a terminal emulation protocol. It is used to access and configure the parameters for the NMC.

Trap (SNMP): This term describes an event that affects a MIB variable. Traps are sent to the manager, which is programmed to perform specific tasks upon reception of the traps.