

DOORS AND PANELS NOT SHOWN

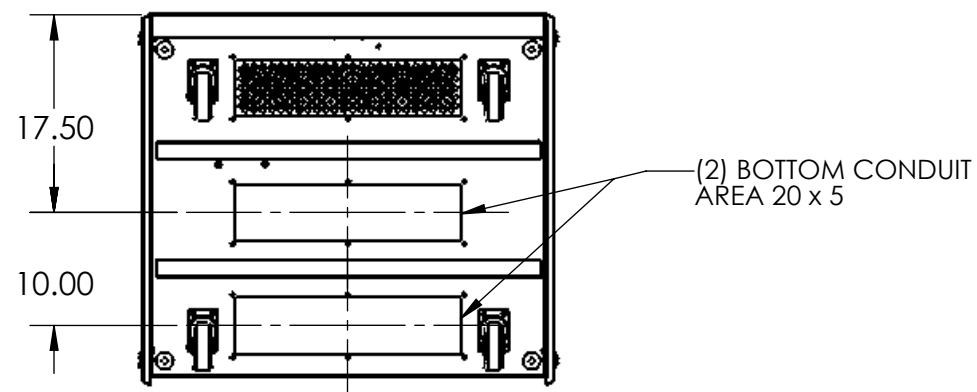
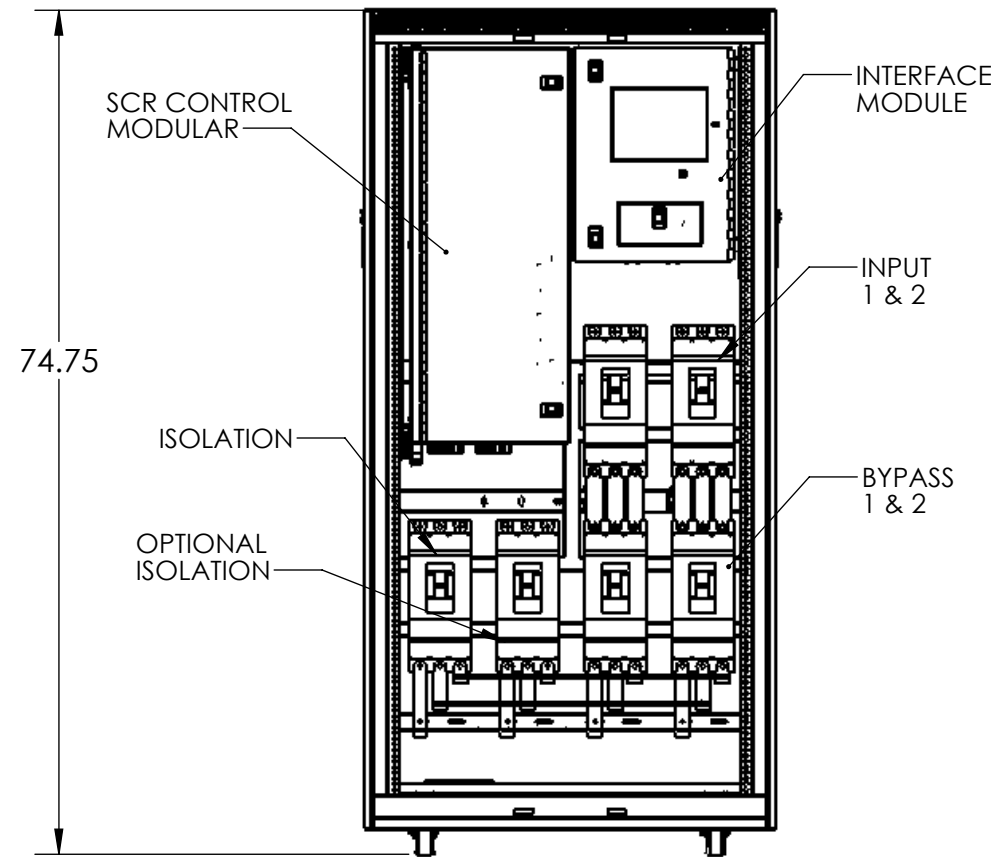

GENERAL NOTES:

1. NEMA 1 RATED CABINET
2. ALL DOOR HAVE LOCKABLE HANDLE WITH COMMON KEY
3. ALL BUS IS SILVER-PLATED COPPER, BASED ON 1000A/ SQ IN.
4. WEIGHT : 1500 LBS.... ESTIMATED
5. OPERATING AMBIENT TEMPERATURE 0C TO 40C (32 F TO 104F)
6. HEAT DISSIPATION AT FULL RATE: 9000 BTU/Hr.
7. FINISH: PDI STANDARD: PEARL WHITE
8. RECOMMENDED MINIMUM CLEARANCE :FRONT: 36" , REAR : 36" FOR SERVICE , SIDE : 6" TOP: 12"

EXTERNAL CONNECTION NOTES:

9. SOURCE AND LOAD RATING: 600V, 800 AMPS, 3 PHASE, 3 WIRE
10. GROUND BUS : 200 AMPS
11. CABLE ENTRANCE THOUGH BOTTOM OR TOP AS SHOWN PUNCH COVER PANELS AS REQUIRE FOR CONDUITS
12. LUG MATERIAL RECOMMENDED: ALUMINUM ALLOY 6061. UL LISTED
13. LUG SCREW TIGHTENING TORQUE PER UL 486B
14. REFER SOURCE AC INPUT CONNECT TO SOURCE 1 INPUT BUS BAR
15. ALTERNATE SOURCE AC INPUT CONNECT TO SOURCE 2 INPUT BUS BAR
16. SEE PAGE 2 FOR INPUT AND OUTPUT BUS LOCATION
17. SEE TABLE 1 FOR RECOMMENDED CABLE SIZE AND LUG

UNLESS OTHERWISE SPECIFIED: DIMENSIONS ARE IN INCHES [] IN MILLIMETER ANGULAR: ±0.5° BEND ±1° TWO PLACE DECIMAL ±0.02 THREE PLACE DECIMAL ±0.005		THIS DRAWING CONTAINS CONFIDENTIAL & PROPRIETARY INFORMATION AND SHALL NOT BE DISCLOSED OR COPIED WITHOUT THE EXPRESSED, WRITTEN PERMISSION OF SMITHS POWER	
THIRD ANGLE PROJECTION		DO NOT SCALE DRAWING	
APPROVALS		DATE	
DRAWN	LJN	07-07-11	
CHECKED			
ENG. APPR.			

		
TITLE: 400 AMP STAND ALONE w SIDE CABLE ACCESS		
SIZE B	DWG. NO. DWG40003	REV B
PART NO.		SHEET 1 OF 2

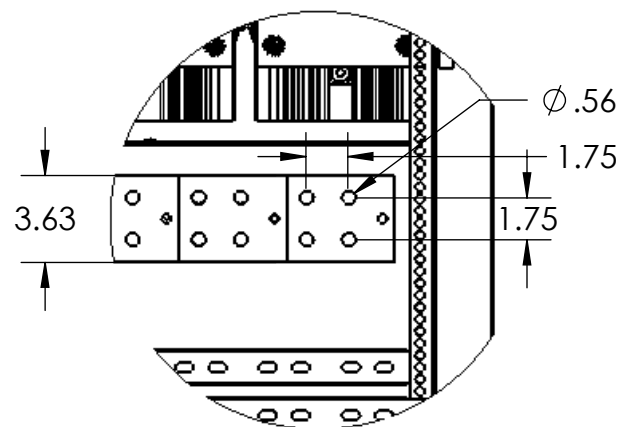
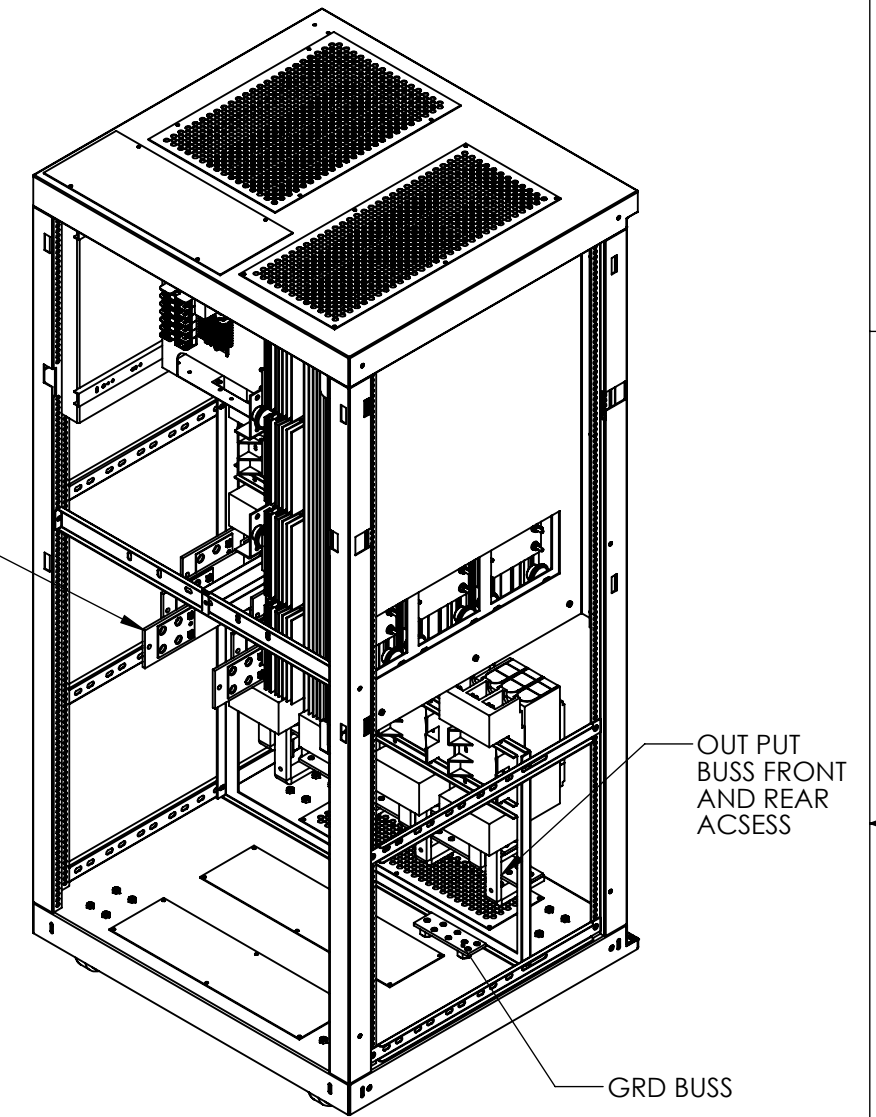
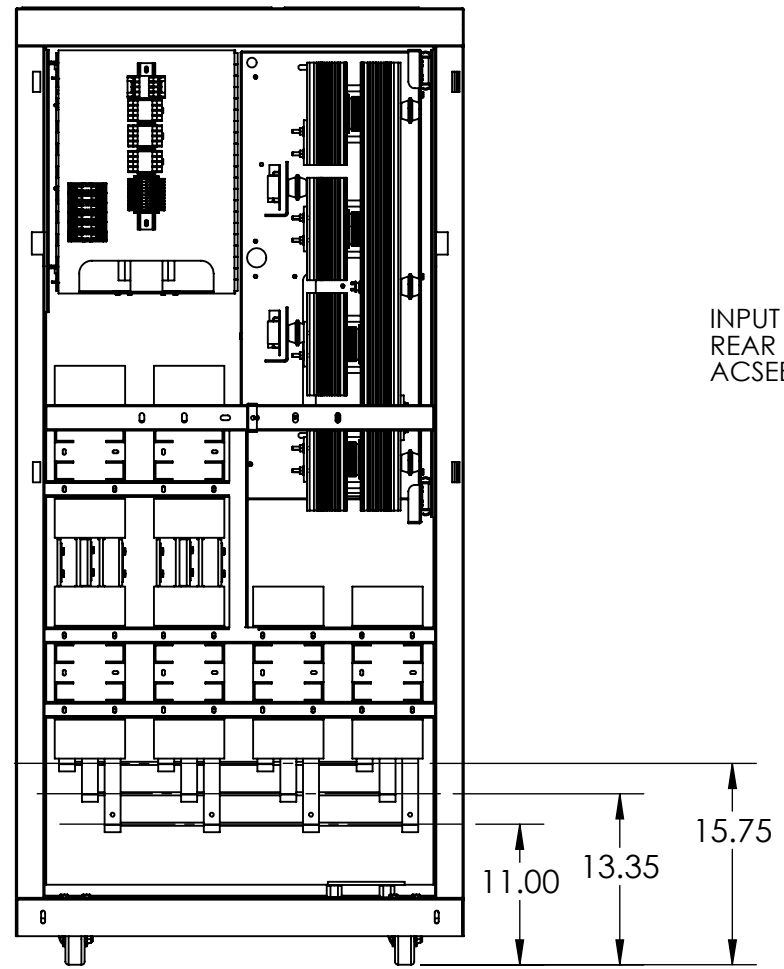
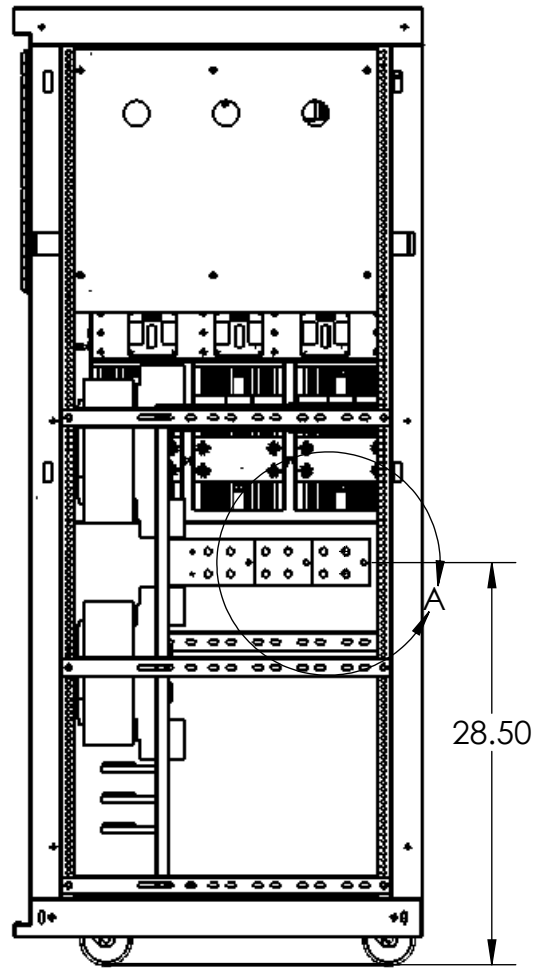

DETAIL A
INPUT BUSS

TABLE 1			
INPUT/OUTPUT	CABLE SIZE	LUG	TIGHTENING TORQUE
400 A	(2) 250 KCMIL	NEMA 2 HOLES COMPRESSION	300 LB-IN
800A	(2) 500 KCMIL	NEMA 2 HOLES COMPRESSION	300 LB-IN
SIGNAL / CONTROL	# 18 AWG	NONE REQUIRED	18 LB-IN

SIZE B	DWG. NO. DWG40003	REV
PART NO. 400 AMP		SHEET 2 OF 2