

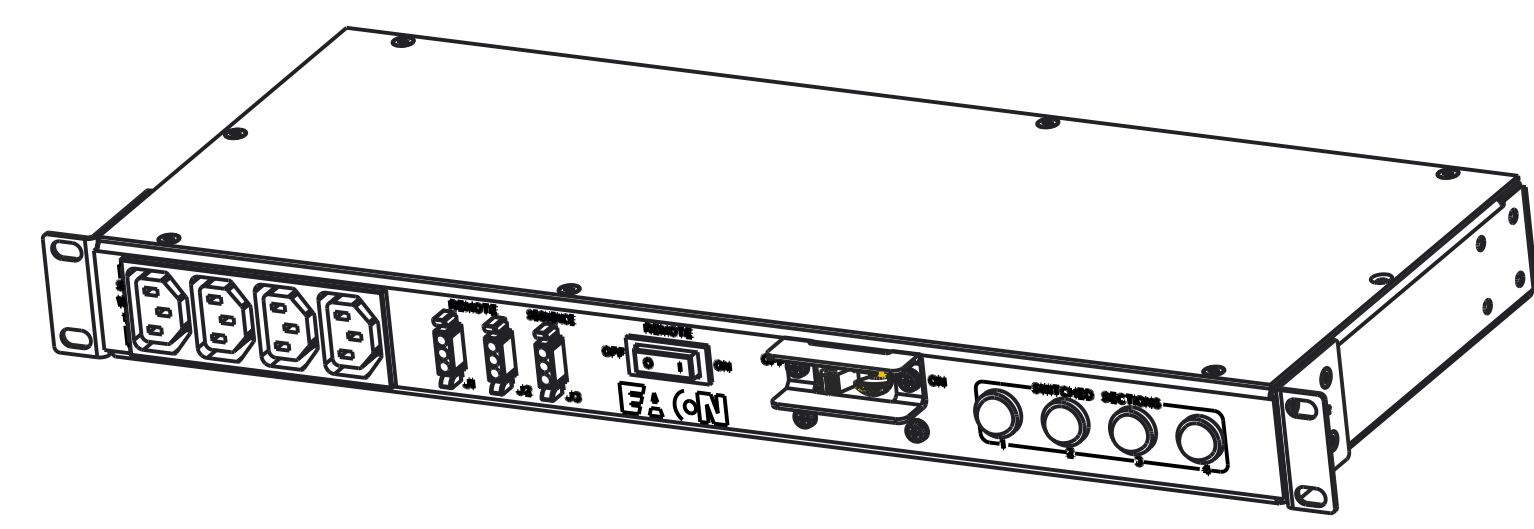

REV	ECO No.	REVISION	DR	CK	AP	AP	DATE

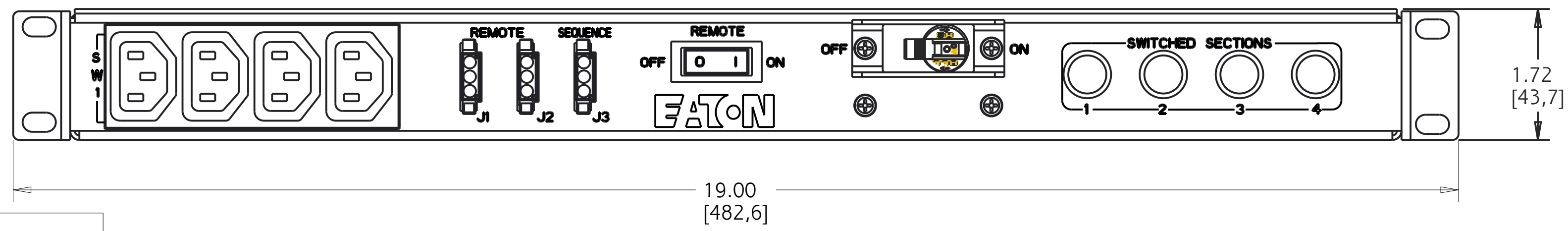
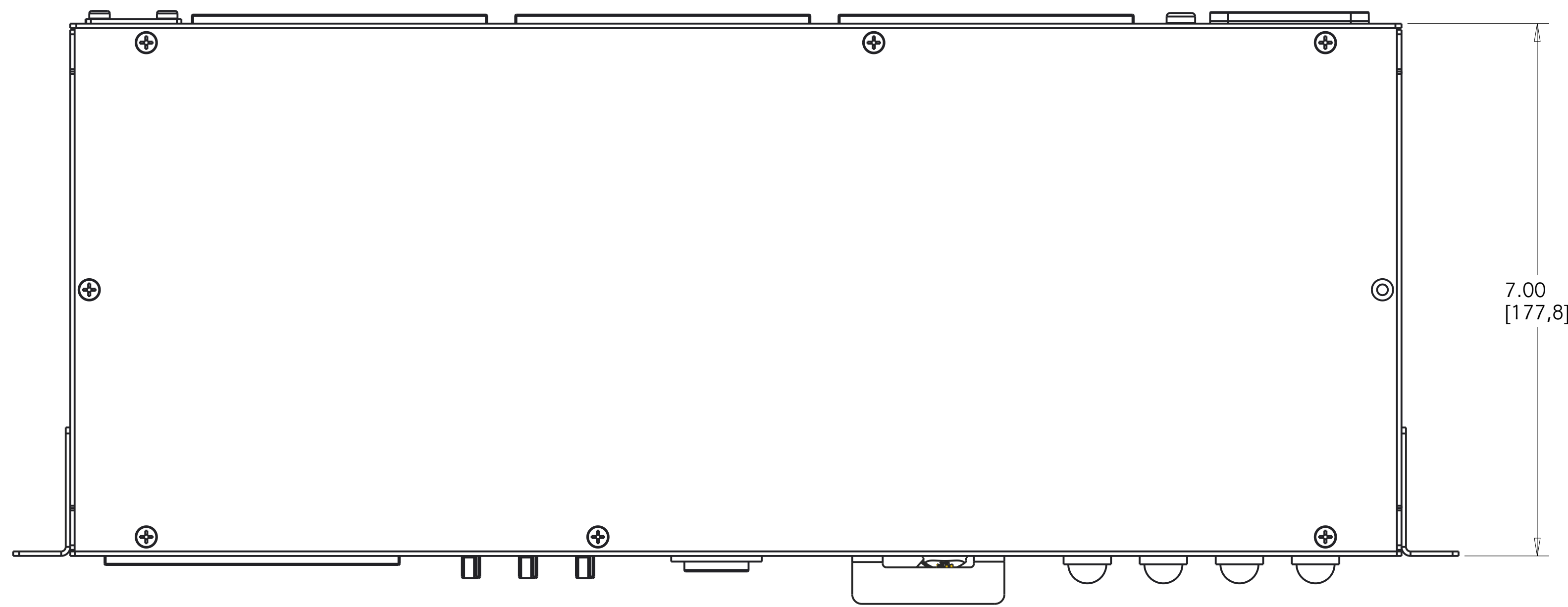
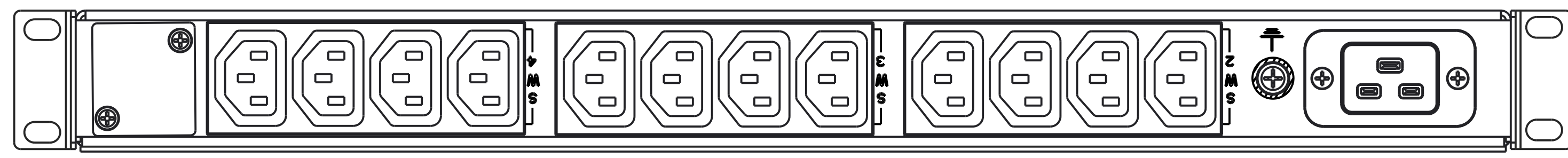

TPC2365-5403-R REMOTE EPO

FUNCTIONALITY POWER CONTROLLER WITH LATCHING REMOTE	INPUT IEC C20 INLET	OUTPUT (16) IEC C13	ENVIRONMENTAL 32° TO 113° F 0° TO 45° C
MECHANICAL 19.00" (482.6mm) WIDTH 1.72" (43.7mm) HEIGHT 7.00" (177.8mm) DEPTH BLACK CHASSIS	INPUT RATING 100-240V ~; 16A W+N+PE OR 2W+PE 50/60HZ	OUTPUT RATING 100-240V ~ 10A MAX PER C13 GANG 16A MAX TOTAL	CERTIFICATIONS   REGULATORY MODEL ER212ECAB1C2LCC
CIRCUIT BREAKER MAIN: (1) 20A 2-POLE LISTED	FILTER AND SPIKE/SURGE EMI/RFI FILTER, COMMON AND DIFFERENTIAL MODE SPIKE/SURGE PROTECTION	INDICATOR LIGHTS FOUR GREEN, ONE FOR EACH SECTION	ACCESSORIES INCLUDED SUB-HRDWARE-001 - PANEL MOUNT KIT SCREWS SPK030 - PANEL MOUNT KIT CAGE NUTS REMOTE02 - REMOTE CONNECTOR KIT (3)

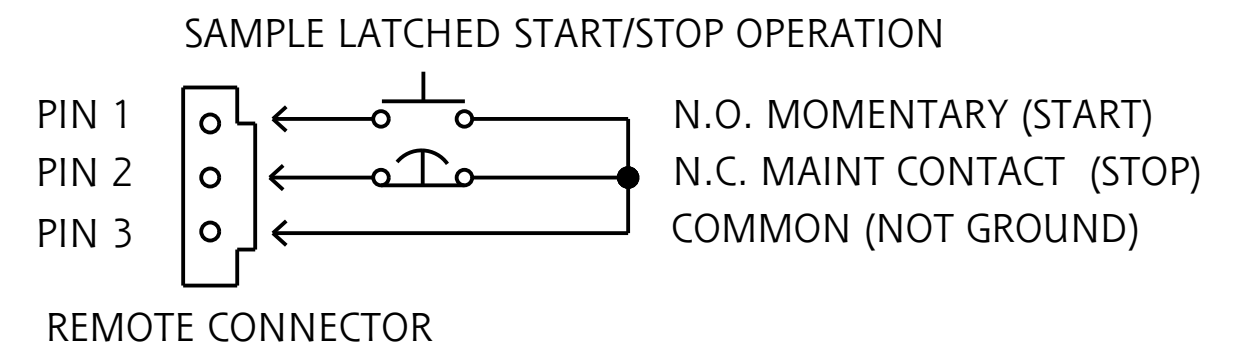

LATCHED REMOTE: REMOTE START ONLY
NO MTD: ALL SECTIONS POWER UP WHEN
UNIT IS STARTED

METRIC	THIRD ANGLE PROJECTION	EATON CORPORATION, ELECTRICAL		SIZE D
SPECIFICATION DRAWING TPC2365-5403-R				
MODIFIED BY: J. OSBORNE	DATE: 5 JUNE 2018	UNLESS OTHERWISE SPECIFIED TOLERANCES ON DIMENSIONS ARE: ANGLES: ±1/2° HOLES: ±0.13		SCALE: 0.800 DO NOT SCALE DRAWING OR CHANGE MANUALLY
ECO: 141178	STATE: RELEASE	DECIMALS: 0.X; ±0.75 X; (FOR X < 3); ±1	DIAM: ±0.25 X; (FOR X > 3); ±2.5	
PRO-ENGINEER GENERATED		PART NAME: TPC2365-5403-R	REVISION: 01	SHEET: 1 of 1
<small>EATON CORPORATION - CONFIDENTIAL AND PROPRIETARY NOTICE TO PERSONS RECEIVING THIS DOCUMENT AND/OR TECHNICAL INFORMATION THIS DOCUMENT, INCLUDING THE DRAWING AND INFORMATION CONTAINED THEREON, IS CONFIDENTIAL AND IS THE EXCLUSIVE PROPERTY OF EATON CORPORATION AND IS HEREBY ON LOAN AND SUBJECT TO RECALL BY EATON AT ANY TIME. BY TAKING POSSESSION OF THIS DOCUMENT, THE RECIPIENT ACKNOWLEDGES AND AGREES THAT THIS DOCUMENT CANNOT BE USED IN ANY MANNER ADVERSE TO THE INTERESTS OF EATON, AND THAT NO PORTION OF THIS DOCUMENT MAY BE COPIED OR OTHERWISE REPRODUCED WITHOUT THE PRIOR WRITTEN CONSENT OF EATON. IN THE CASE OF CONFLICTING CONTRACTUAL PROVISIONS, THIS NOTICE SHALL GOVERN THE STATUS OF THIS DOCUMENT. © 2008 Eaton Corporation - All Rights Reserved.</small>				