

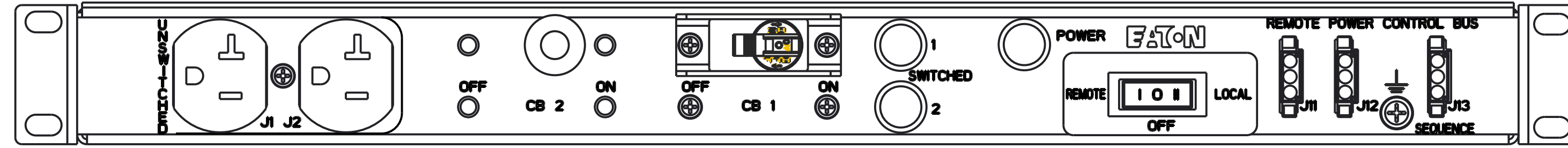

REV	ECO No.	REVISION	DR	CK	AP	DATE

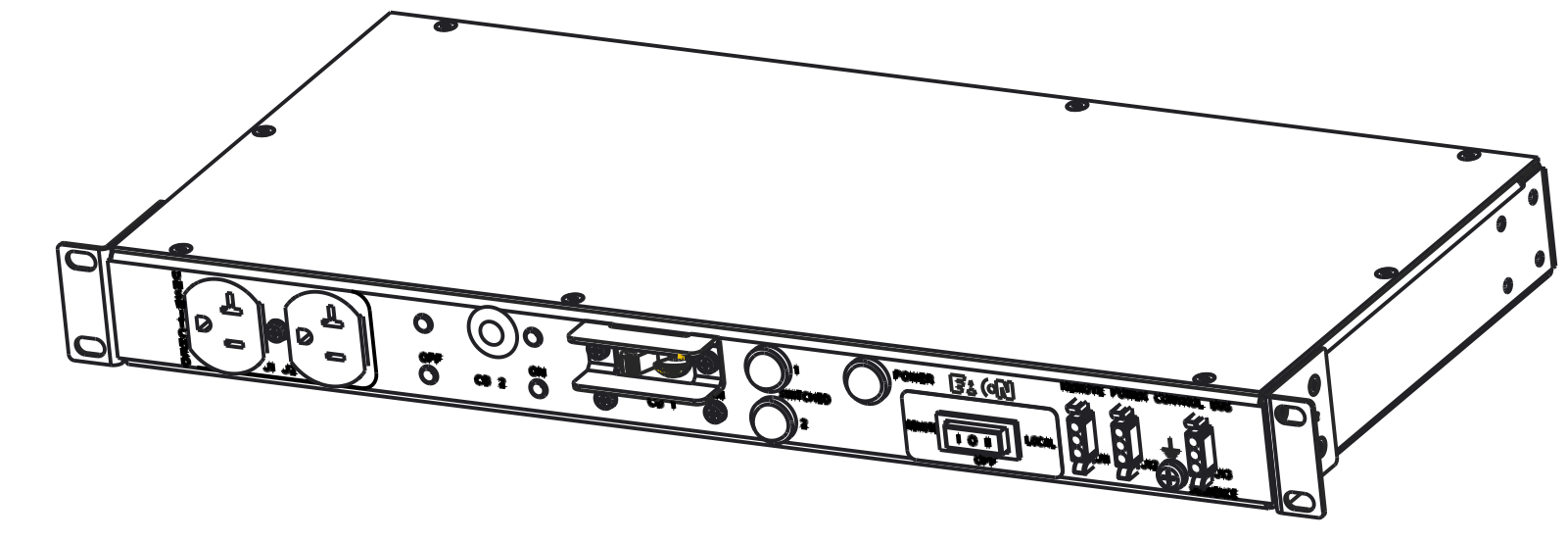
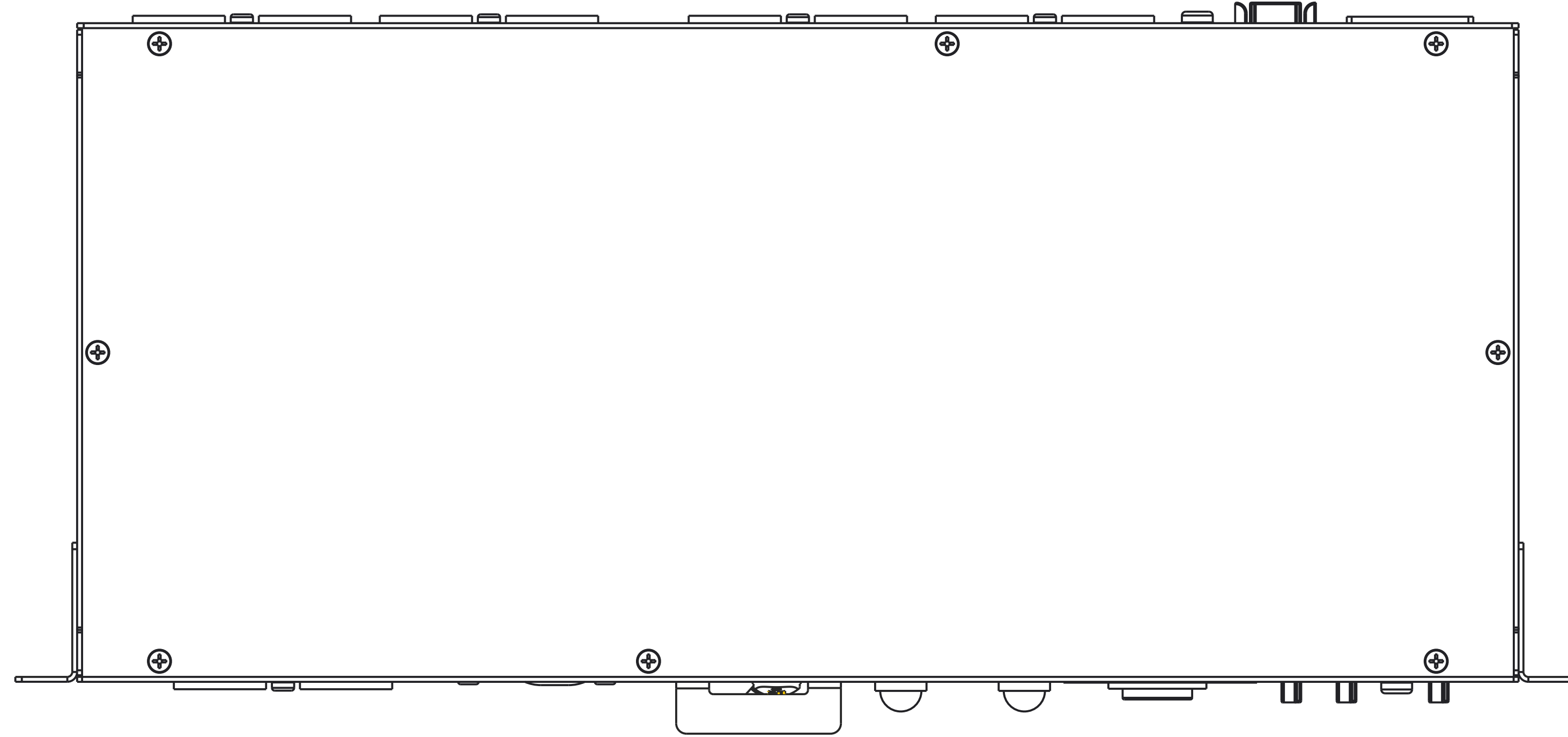
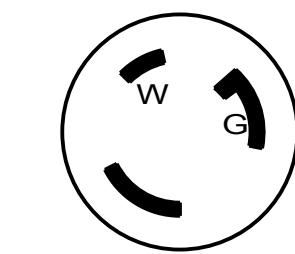
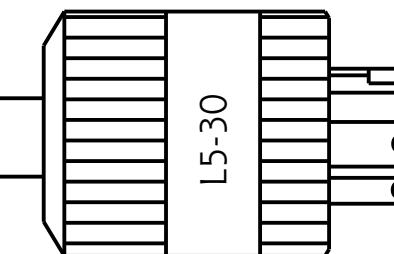
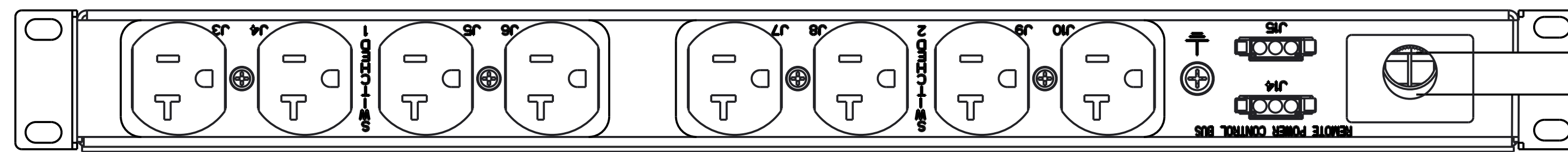

# TPC115-10D-R REMOTE CONTROL

<b>FUNCTIONALITY</b> POWER CONTROLLER WITH STANDARD REMOTE	<b>INPUT</b> NEMA L5-30 PLUG 15FT 10AWG / 3C POWERCORD	<b>OUTPUT</b> (10) NEMA 5-20 RECEPTACLES: (8) SWITCHED (2) UNSWITCHED	<b>ENVIRONMENTAL</b> 32° TO 113° F 0° TO 45° C
<b>MECHANICAL</b> 19.00" (482.6mm) WIDTH 1.72" (43.7mm) HEIGHT 8.00" (203.2mm) DEPTH BLACK CHASSIS	<b>INPUT RATING</b> 100-127V ~ W + N + PE 24A 50/60HZ	<b>OUTPUT RATING</b> 100-127V ~ 16A MAX PER SECTION 24A MAX TOTAL	<b>CERTIFICATIONS</b>  REGULATORY MODEL ER212MGYB1D2TEF
<b>CIRCUIT BREAKERS</b> 20A 2-POLE LISTED CB1	<b>FILTER AND SPIKE/SURGE</b> EMI/RFI FILTER, COMMON AND DIFFERENTIAL MODE SPIKE/SURGE PROTECTION	<b>INDICATOR LIGHTS</b> ONE GREEN FOR MAIN POWER; TWO GREEN, ONE FOR EACH SECTION	<b>ACCESSORIES INCLUDED</b> SUB-HRDWARE-001 - PANEL MOUNT KIT SCREWS SPK030 - PANEL MOUNT KIT CAGE NUTS REMOTE02 - REMOTE CONNECTOR KIT (5)

SAMPLE START/STOP REMOTE STATION

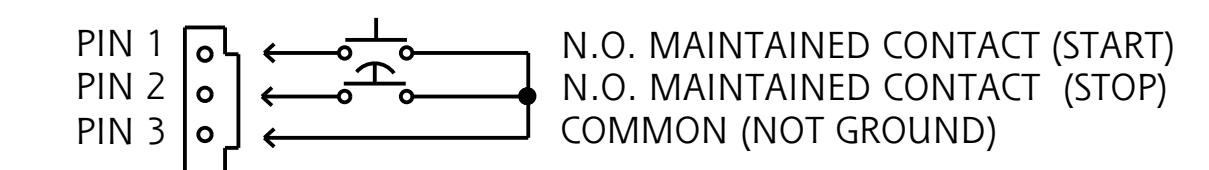

REMOTE CONNECTOR

STANDARD REMOTE: REMOTE AND LOCAL START.  
 NO MTD: ALL SECTIONS POWER UP WHEN UNIT IS STARTED

METRIC	THIRD ANGLE PROJECTION	EATON CORPORATION, ELECTRICAL	<b>EATON</b>	SIZE D
SPECIFICATION DRAWING TPC115-10D-R				
MODIFIED BY: J. OSBORNE	DATE: 24 MAY 2018	UNLESS OTHERWISE SPECIFIED TOLERANCES ON DIMENSIONS ARE: ANGLES: ±1/2°    DECIMALS: 0.X: ±0.25 X, (FOR X < 3): ±1 HOLES: ±0.13    DIMENSIONS ARE IN MILLIMETERS (INCHES) AND AFTER PLATING		SCALE: 0.800 DO NOT SCALE DRAWING OR CHANGE MANUALLY
ECO: 140920	STATE: RELEASE	PRO-ENGINEER GENERATED	PART NAME: TPC115-10D-R	REVISION: 01    SHEET: 1 of 1
<small>EATON CORPORATION - CONFIDENTIAL AND PROPRIETARY NOTICE TO PERSONS RECEIVING THIS DOCUMENT AND/OR TECHNICAL INFORMATION THIS DOCUMENT, INCLUDING THE DRAWING AND INFORMATION CONTAINED THEREON, IS CONFIDENTIAL AND IS THE EXCLUSIVE PROPERTY OF EATON CORPORATION AND IS HEREBY ON LOAN AND SUBJECT TO RECALL BY EATON AT ANY TIME. BY TAKING POSSESSION OF THIS DOCUMENT, THE RECIPIENT ACKNOWLEDGES AND AGREES THAT THIS DOCUMENT CANNOT BE USED IN ANY MANNER ADVERSE TO THE INTERESTS OF EATON, AND THAT NO PORTION OF THIS DOCUMENT MAY BE COPIED OR OTHERWISE REPRODUCED WITHOUT THE PRIOR WRITTEN CONSENT OF EATON. IN THE CASE OF CONFLICTING CONTRACTUAL PROVISIONS, THIS NOTICE SHALL GOVERN THE STATUS OF THIS DOCUMENT. © 2008 Eaton Corporation - All Rights Reserved.</small>				