

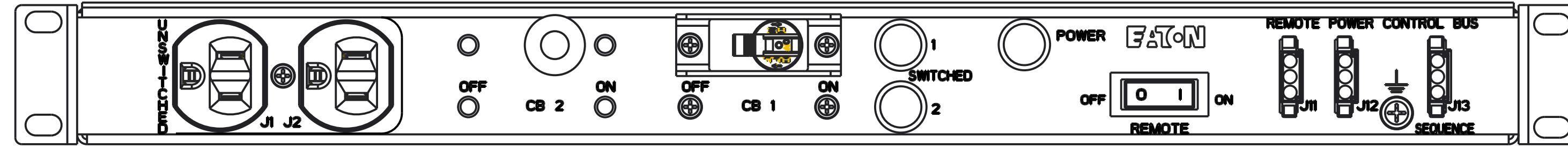

REV	ECO No.	REVISION	DR	CK	AP	DATE

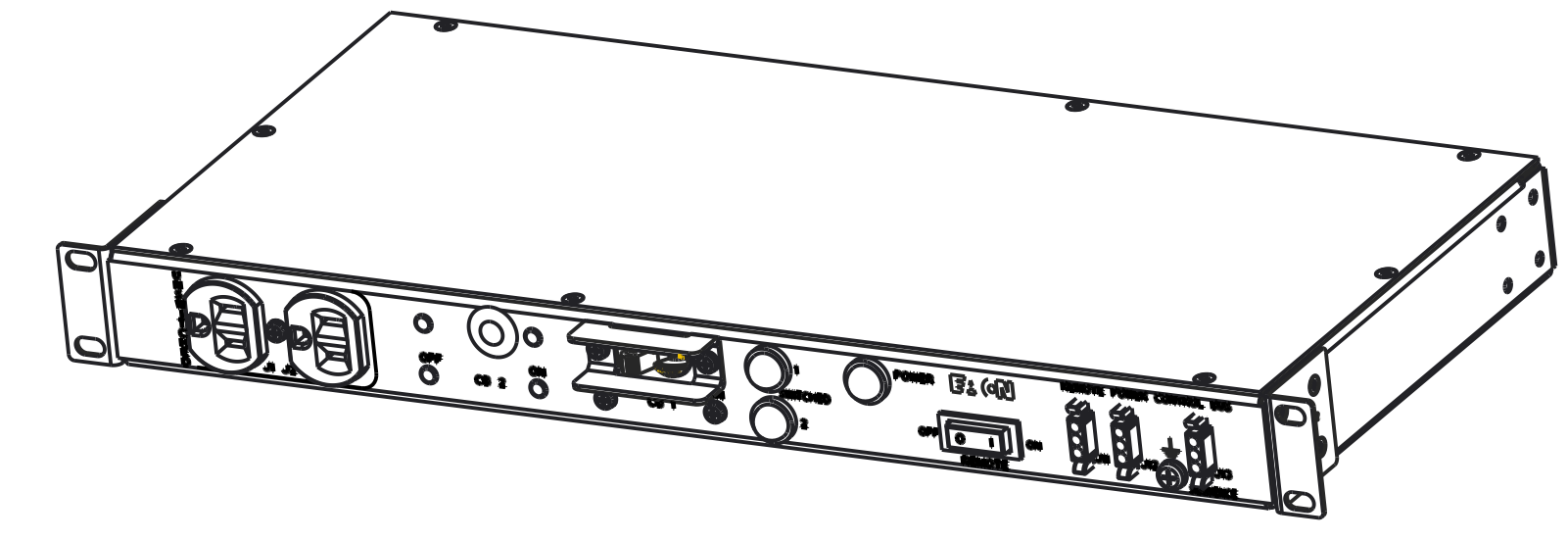
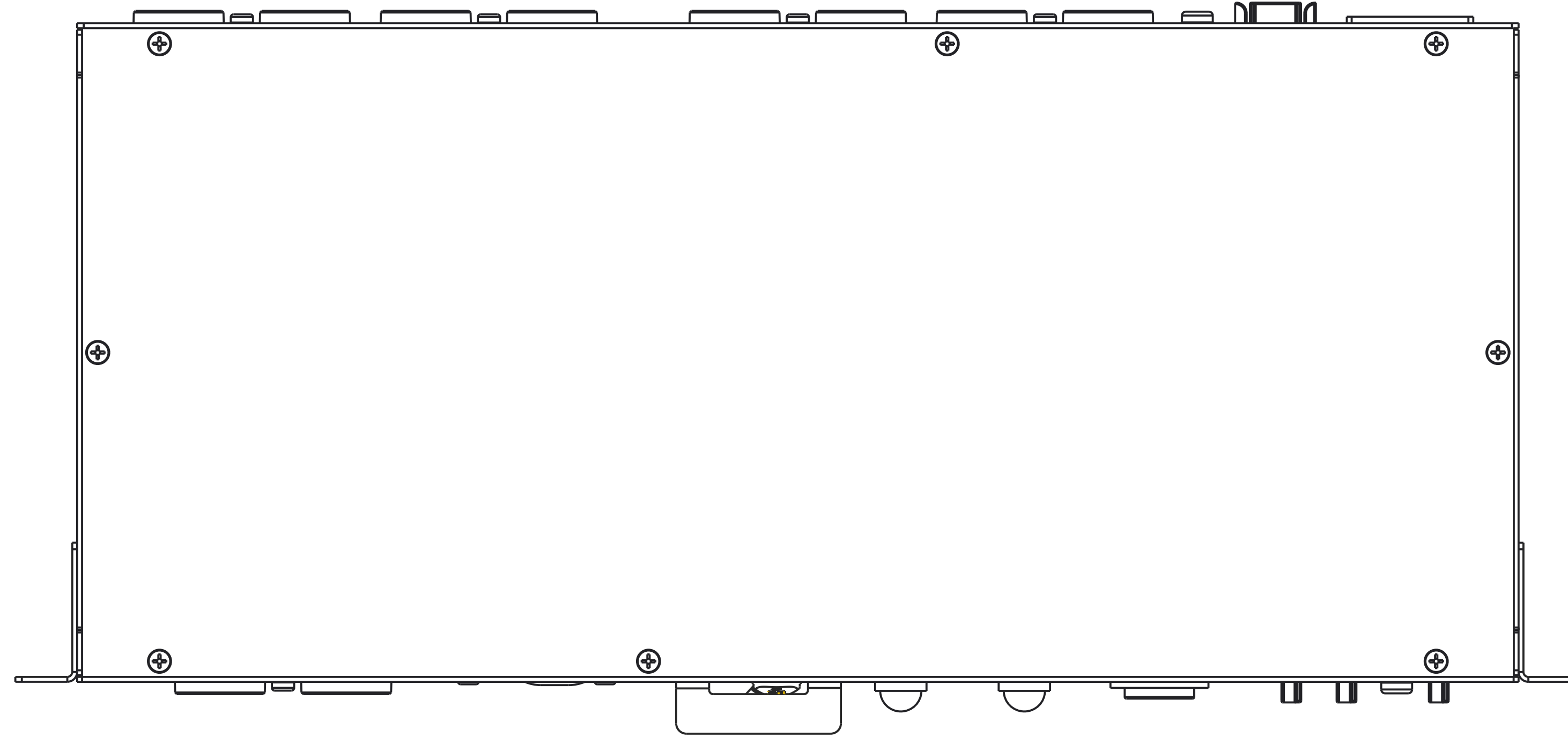
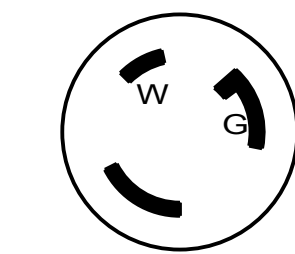
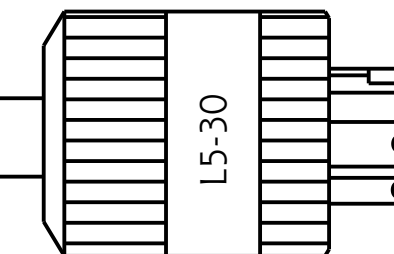
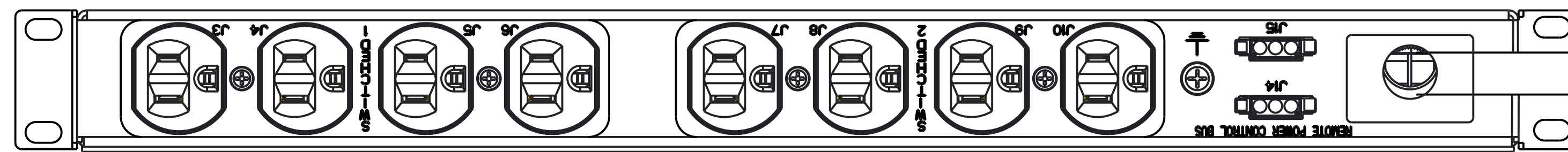

TPC115-10C-LMR REMOTE CONTROL

FUNCTIONALITY POWER CONTROLLER WITH LATCHING REMOTE	INPUT NEMA L5-30 PLUG 15FT 10AWG / 3C POWERCORD	OUTPUT (10) NEMA 5-15 RECEPTACLES: (8) SWITCHED (2) UNSWITCHED	ENVIRONMENTAL 32° TO 113° F 0° TO 45° C
MECHANICAL 19.00" (482.6mm) WIDTH 1.72" (43.7mm) HEIGHT 8.00" (203.2mm) DEPTH BLACK CHASSIS	INPUT RATING 100-127V ~ W + N + PE 24A 50/60HZ	OUTPUT RATING 100-127V ~ 16A MAX PER SECTION 24A MAX TOTAL	CERTIFICATIONS  REGULATORY MODEL ER212MGYB1D2MEB
CIRCUIT BREAKERS 20A 2-POLE LISTED CB1	FILTER AND SPIKE/SURGE EMI/RFI FILTER, COMMON AND DIFFERENTIAL MODE SPIKE/SURGE PROTECTION	INDICATOR LIGHTS ONE GREEN FOR MAIN POWER; TWO GREEN, ONE FOR EACH SECTION	ACCESSORIES INCLUDED SUB-HRDWARE-001 - PANEL MOUNT KIT SCREWS SPK030 - PANEL MOUNT KIT CAGE NUTS REMOTE02 - REMOTE CONNECTOR KIT (5)

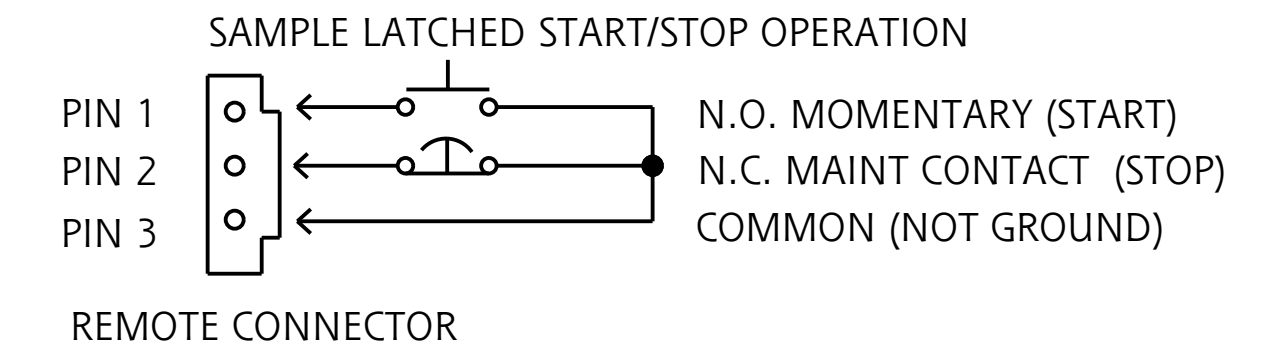

LATCHED REMOTE: REMOTE START ONLY.
 MTD: SECTIONS POWER UP AT 4-SECOND INTERVALS WHEN UNIT IS STARTED.

METRIC	THIRD ANGLE PROJECTION	EATON CORPORATION, ELECTRICAL	EATON	SIZE D
SPECIFICATION DRAWING TPC115-10C-LMR				
MODIFIED BY: J. OSBORNE	DATE: 7 JUNE 2018	UNLESS OTHERWISE SPECIFIED TOLERANCES ON DIMENSIONS ARE: ANGLES: ±1/2° DECIMALS: 0.X: ±0.25 X, (FOR X < 3): ±1 HOLES: ±0.13 0.XX: ±0.25 X (FOR X > 3); ±2.5 DIMENSIONS ARE IN MILLIMETERS (INCHES) AND AFTER PLATING		SCALE: 0.800 DO NOT SCALE DRAWING OR CHANGE MANUALLY
ECO: 141839	STATE: RELEASE	PRO-ENGINEER GENERATED	PART NAME: TPC115-10C-LMR	REVISION: 01 SHEET: 1 of 1
<small>EATON CORPORATION - CONFIDENTIAL AND PROPRIETARY NOTICE TO PERSONS RECEIVING THIS DOCUMENT AND/OR TECHNICAL INFORMATION THIS DOCUMENT, INCLUDING THE DRAWING AND INFORMATION CONTAINED THEREON, IS CONFIDENTIAL AND IS THE EXCLUSIVE PROPERTY OF EATON CORPORATION AND IS HEREBY ON LOAN AND SUBJECT TO RECALL BY EATON AT ANY TIME. BY TAKING POSSESSION OF THIS DOCUMENT, THE RECIPIENT ACKNOWLEDGES AND AGREES THAT THIS DOCUMENT CANNOT BE USED IN ANY MANNER ADVERSE TO THE INTERESTS OF EATON, AND THAT NO PORTION OF THIS DOCUMENT MAY BE COPIED OR OTHERWISE REPRODUCED WITHOUT THE PRIOR WRITTEN CONSENT OF EATON. IN THE CASE OF CONFLICTING CONTRACTUAL PROVISIONS, THIS NOTICE SHALL GOVERN THE STATUS OF THIS DOCUMENT. © 2008 Eaton Corporation - All Rights Reserved.</small>				