

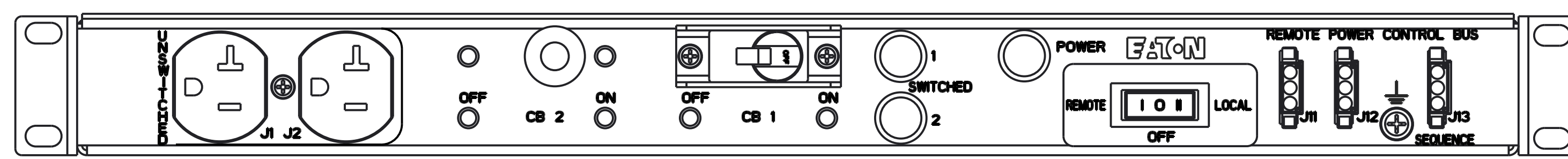

REV	ECO No.	REVISION	DR	CK	AP	DATE

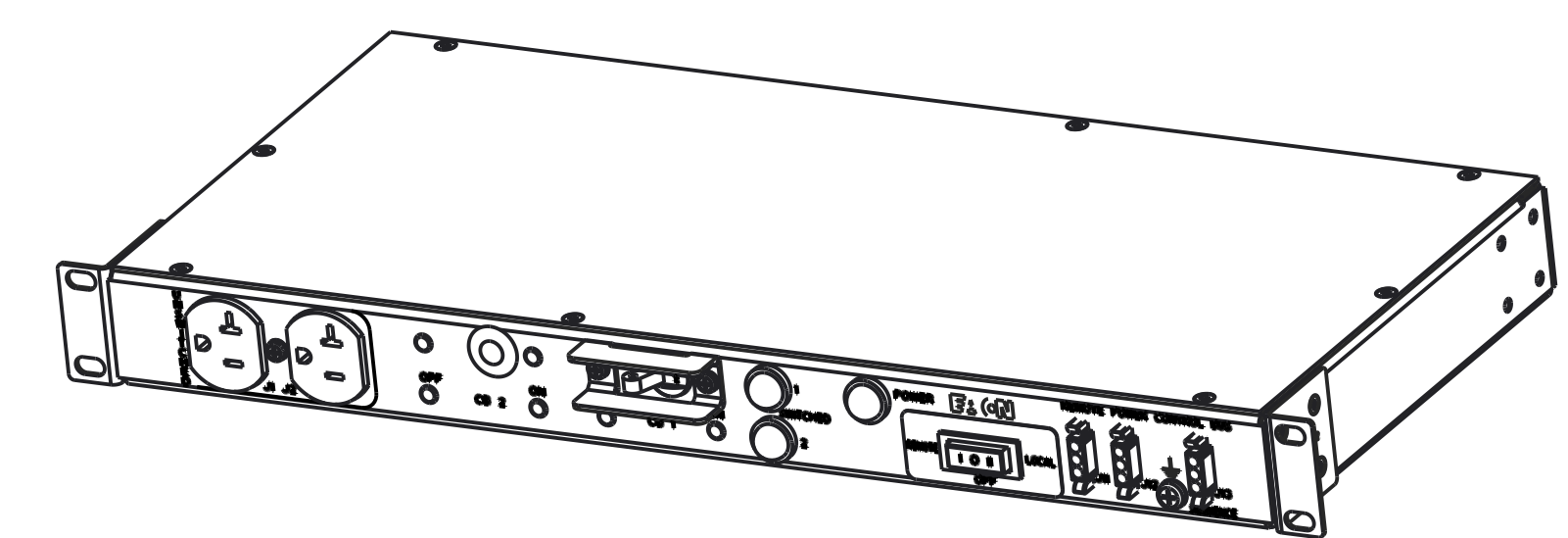
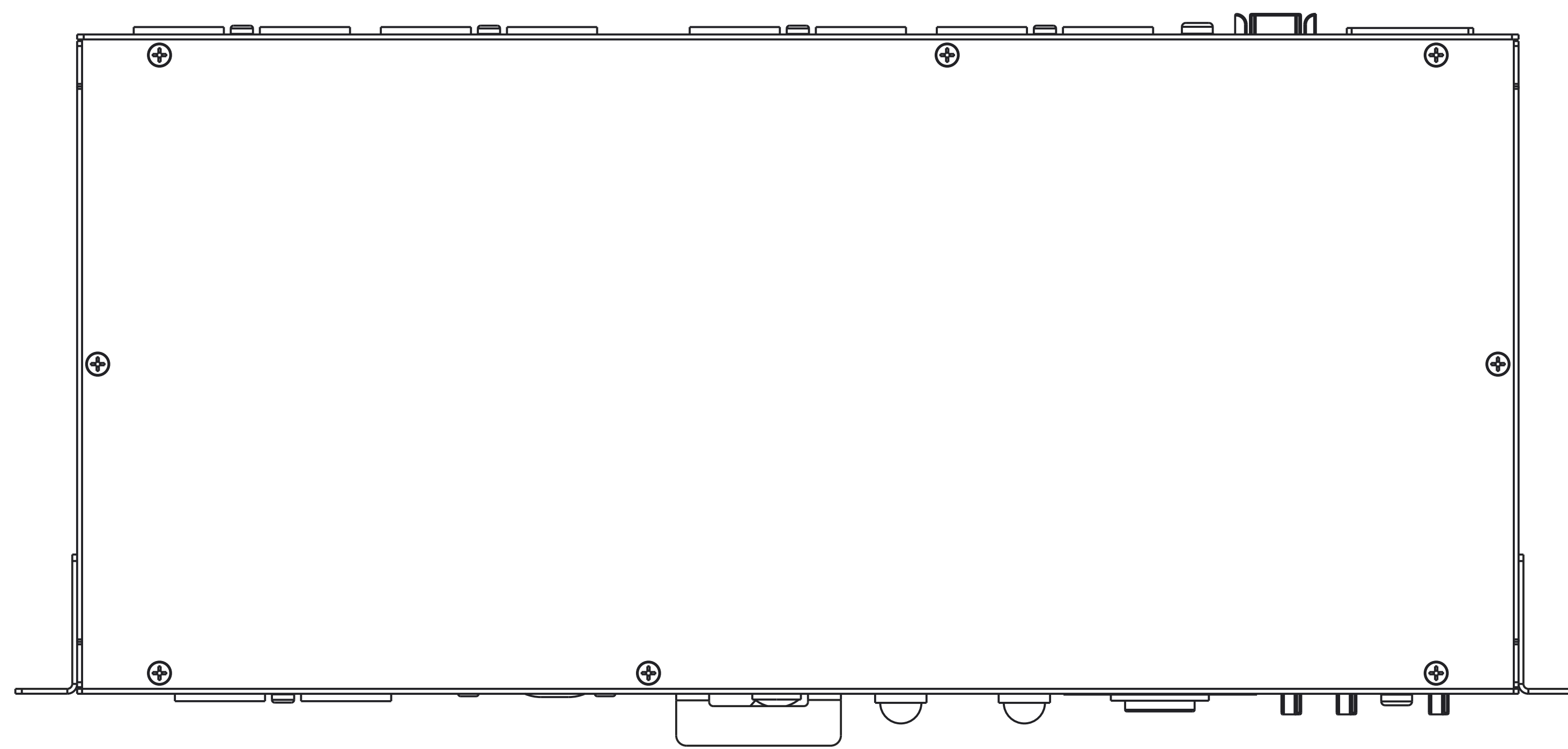
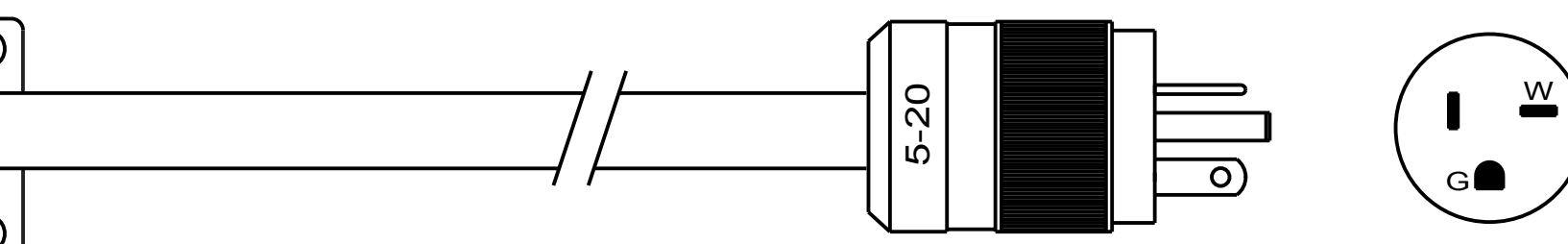
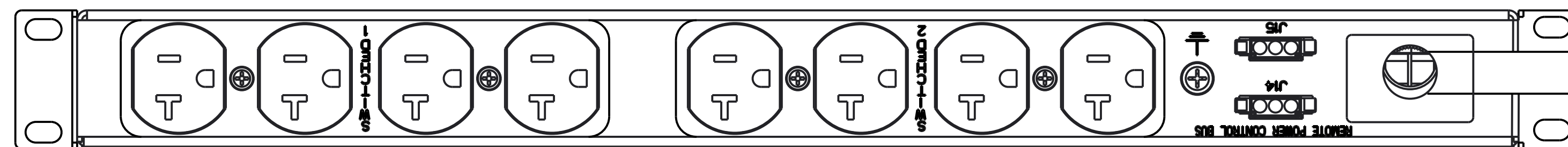

TPC115-10A2-MTR REMOTE CONTROL

FUNCTIONALITY POWER CONTROLLER WITH STANDARD REMOTE	INPUT NEMA 5-20 PLUG 10FT 12AWG / 3C POWERCORD	OUTPUT (10) NEMA 5-20 RECEPTACLES: (8) SWITCHED (2) UNSWITCHED	ENVIRONMENTAL 32° TO 113° F 0° TO 45° C
MECHANICAL 19.00" (482.6mm) WIDTH 1.72" (43.7mm) HEIGHT 8.00" (203.2mm) DEPTH BLACK CHASSIS	INPUT RATING 100-127V ~ 16A 50/60HZ	OUTPUT RATING 100-127V ~ 16A MAX 16A MAX TOTAL	CERTIFICATIONS  REGULATORY MODEL ER212MCXG1B2UEF
CIRCUIT BREAKERS 20A 1-POLE LISTED CB1	FILTER AND SPIKE/SURGE EMI/RFI FILTER, COMMON AND DIFFERENTIAL MODE SPIKE/SURGE PROTECTION	INDICATOR LIGHTS ONE GREEN FOR MAIN POWER; TWO GREEN, ONE FOR EACH SECTION	ACCESSORIES INCLUDED SUB-HRDWARE-001 - PANEL MOUNT KIT SCREWS SPK030 - PANEL MOUNT KIT CAGE NUTS REMOTE02 - REMOTE CONNECTOR KIT (5)

SAMPLE START/STOP REMOTE STATION

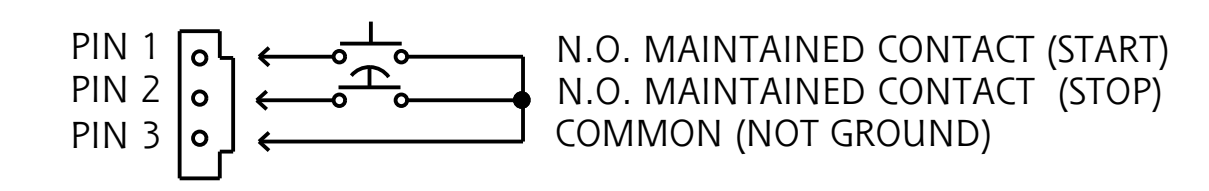

REMOTE CONNECTOR

STANDARD REMOTE: REMOTE AND LOCAL START.
 MTD: 4-SECOND POWER-UP DELAY BETWEEN EACH SECTION

METRIC	THIRD ANGLE PROJECTION	EATON CORPORATION, ELECTRICAL	EATON	SIZE D
SPECIFICATION DRAWING TPC115-10A2-MTR				
MODIFIED BY: J. OSBORNE	DATE: 18 APR 2018	UNLESS OTHERWISE SPECIFIED TOLERANCES ON DIMENSIONS ARE: ANGLES: ±1/2° HOLES: ±0.013 DIMENSIONS ARE IN MILLIMETERS (INCHES) AND AFTER PLATING		SCALE: 0.800 DO NOT SCALE DRAWING OR CHANGE MANUALLY
ECO: 138719	STATE: RELEASE	PART NAME: TPC115-10A2-MTR		REVISION: 01
PRO-ENGINEER GENERATED		PART NAME: TPC115-10A2-MTR		SHEET: 1 of 1
<small>EATON CORPORATION - CONFIDENTIAL AND PROPRIETARY NOTICE TO PERSONS RECEIVING THIS DOCUMENT AND/OR TECHNICAL INFORMATION THIS DOCUMENT, INCLUDING THE DRAWING AND INFORMATION CONTAINED THEREON, IS CONFIDENTIAL AND IS THE EXCLUSIVE PROPERTY OF EATON CORPORATION AND IS HEREBY ON LOAN AND SUBJECT TO RECALL BY EATON AT ANY TIME. BY TAKING POSSESSION OF THIS DOCUMENT, THE RECIPIENT ACKNOWLEDGES AND AGREES THAT THIS DOCUMENT CANNOT BE USED IN ANY MANNER ADVERSE TO THE INTERESTS OF EATON, AND THAT NO PORTION OF THIS DOCUMENT MAY BE COPIED OR OTHERWISE REPRODUCED WITHOUT THE PRIOR WRITTEN CONSENT OF EATON. IN THE CASE OF CONFLICTING CONTRACTUAL PROVISIONS, THIS NOTICE SHALL GOVERN THE STATUS OF THIS DOCUMENT. © 2008 Eaton Corporation - All Rights Reserved.</small>				