

Handbook

# Quick guide to power distribution

April 2019

**EATON**  
*Powering Business Worldwide*

Switch  N to Eaton.

# Introduction

Rack power distribution units, also known as rack PDUs, are a key component to any IT environment. As the name suggests, they distribute power to network equipment within racks. A common misconception is that they're just power strips, and at first glance, they even look like it, but modern rack PDUs provide benefits a simple power strip cannot. Some of the valuable features include network connectivity, environmental monitoring and remote access, but we'll get more into that later.

This guide should help you get familiar with power distribution, gain interesting insights and learn some key considerations for future IT investments.



## Table of contents

Introduction .....	2
What is power distribution? .....	3
Types of power distribution .....	3
Rack-based versus cabinet-based .....	4
Rack PDU installation options .....	5
Tour a rack PDU .....	6
Rack PDU plugs and receptacles .....	7
Tour a configurable PDU .....	9
Gaining a full understanding of PDU technology .....	10
Questions to consider when choosing a PDU .....	12
History of rack PDUs .....	13
Typical PDU configurations with UPS models .....	14
Power planning for non-traditional environments .....	16
PDU software capability .....	18
Power utilization .....	19
Spilling the beans on coffee & PDUs .....	20

I DON'T DISTRIBUTE  
ANY OF MY POWER!







## Power distribution from network closets to data centers

# What is power distribution?

Power distribution is facilitated through different pieces of equipment that take the power conditioned by your uninterruptible power supply (UPS) and send it to your IT equipment. Power distribution solutions can manage and even control energy consumption in smaller environments as well as large data center applications. Distributing power efficiently results in reduced operating costs and increased reliability.

# Types of power distribution

Whether you need integrated power distribution within a few racks or power throughout your data center, there are many solutions to consider when building out your power infrastructure. Understanding your environment and power needs allows you to begin right-sizing your distribution equipment.

Out of all the equipment listed on the next page, rack PDUs are the most common in IT environments (big or small). We will spend the remainder of this guide digging deeper into rack PDUs and their value, but first let's introduce different types of power distribution.

Rack-based

Cabinet-based

This diagram is a simple representation of how power flows in an IT environment:



In a larger data center environment, the power infrastructure will typically have more elements, and may flow like seen in this diagram:



# Rack-based versus cabinet-based

## Rack-based

**A Rack PDUs** are used to effectively distribute power in rack environments with multiple outlets and a range of intelligent features to help control the power distributed to IT devices. Rack PDUs are used in all types of environments sizes and come in a variety of plug and outlet configurations, including 120 and 200-240 volts. Whether it's the only distribution unit or part of a whole distribution strategy, it's a vital connection point and allows you to protect your entire IT investment.

**Which type of rack PDU is right for you? Go to page 8 to find out.**

**B Rack automatic transfer switches (ATS)** are designed for switching non-phase synchronized AC power sources. They provide automatic transfers from a primary to secondary source to power critical equipment without interruption. Rack ATSs are most commonly seen in network closets and server rooms.

## Cabinet-based

**C Power distribution racks (PDR)** are typically seen in larger high-density data center environments. A power distribution rack provides space-saving power distribution in a flexible design. These racks can offer 168 circuits and accommodate more servers with multiple power cords and rack PDUs with growing loads.

**D Power distribution cabinets of large PDUs** are often seen in large data centers for raised and non-raised floor applications to take incoming power and distribute it to an individual rack or groups of racks. Distribution capacity can range from 84 to 252 circuit breaker pole positions. A PDU can optimize utilization and availability down to the branch circuit level as well as address specific needs for isolation, voltage transformation, harmonic reduction, and voltage regulations. Cabinet-based PDUs should have monitoring capabilities as well.

**E Remote power panels (RPPs)** facilitate power distribution with up to 168 factory-installed branch breaker in a highly compact footprint and has extensive monitoring options. They allow for electrical expansion without the need of costly electrical rework, feeding the RPP distribution module from the existing transformer or panelboard.

## Other

**F Busways** are most often seen in high-density data center applications providing flexible overhead power distribution where change and adaptation are important. Busways don't take up any floor space and allow flexibility in data center design and scalability.



# Rack PDU installation options

How will you be installing your rack PDU? While seemingly minor, mapping out how you will set up your rack space before buying the equipment will be a time- and cost-saving activity.



Here is an example of two PDUs vertically mounted in the 0U rail space of a compatible rack with tool-less installation.

## Vertical mount

Vertically mounted PDUs have up to 60 outlets and are installed in the back of the rack in the 0U rail space. The form factor can be tailored to fit most rack heights and can help free up valuable U space being mounted in the rear of the rack. Vertically mounted PDUs free up your rack space when in the back of the rack. Mounting your PDU can potentially take time, so you should think about how you want to install it and what tools will be required. You may have the option for tool-less installation, which is a great feature that's possible in compatible racks.

## Horizontal mount

Horizontally mounted PDUs are installed within the rack U space and sit horizontally in line with your IT equipment. These typically use 1U or 2U of rack space and typically have 8 to 16 outlets.



Here is an example of a horizontally-mounted 1U PDU.

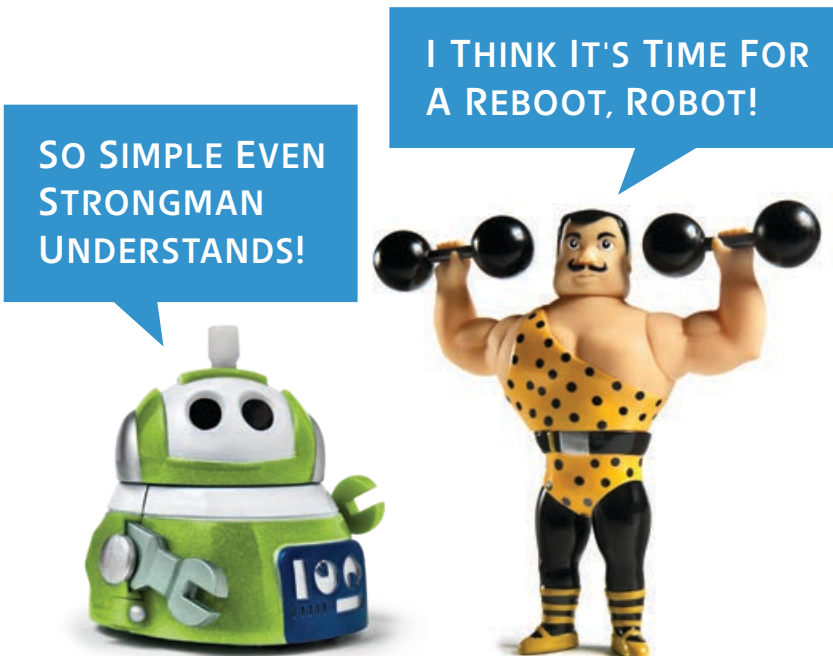

### HELPFUL HINT

Consider how you will be accessing your PDU.

**Where do you need the import cord to face?**

The high density PDU features configurable input cord options, with over 5,000 total combinations. The entry cord position is configured for front or end unit entry.

**If you need to replace the meter on the PDU, will you be able to?**

The metered, managed, and high density PDUs feature hot-swappable technology. This means the communications modules can be replaced without powering down your rack, increasing uptime and enhancing serviceability.

# Tour a rack PDU

Discover the many rack PDU features and benefits available in modern units.

## Grouped reboot for A and B feed

When connecting multiple source input servers to an A and B feed power source, the daisy-chain capability allows you to group power supplies across the rack PDU. As a result, all the power supplies are controlled with a single action, which saves time rebooting servers with two to six power supplies.



Typical server with multiple power inputs powered by two rack PDUs

## Outlet switching

Remotely control devices by powering on or off individual outlets. Save time and operating costs by rebooting machines from your control center without costly site visits.

## Turn off unused outlets

Secure and protect your environment by easily turning off unused outlets. Avoid overloading your system from others plugging in unauthorized devices. Also consider closing access with an outlet cap.



Green LED signifies power on and red is power off to outlet



Cap secures in place with cable tie

## Color-coded outlet sections

Color-coded outlet sections match a corresponding circuit breaker to easily identify which one feeds corresponding outlets and prevent unbalanced loading that would unnecessarily trip a breaker.



Mounting buttons

## One percent billing grade accuracy

**±1%**

Modern PDUs provide one percent revenue-grade power monitoring for higher accuracy in department billing for colocation data centers. Effectively measure power usage to all outlets or individual outlets.



## Advanced LCD pixel display with hot-swap capability

Eaton's new hot-swap eNMC (ePDU Network Management and Control) module can be replaced without the need to power down your rack. Increase uptime while enhancing serviceability and saving on unnecessary service calls. The menu-driven pixel display allows for easy setup and troubleshooting.



Module being removed without removing power to the ePDU

## Daisy chain eight units from one IP address

You can daisy chain up to eight rack PDUs to share the same network connection and IP address.



A and B power PDU sharing a network connection via daisy chain



O is unlocked, + is grip engaged

## Outlet grip functionality

IEC outlet grips secure plugs in place with a lever-actuated grip that's integrated into each outlet. Once the levers click into the grip position, the plugs are secured from accidental disconnect due to bumps or vibrations without the need for special power cords.



# Rack PDU plugs and receptacles

An overview of the different styles of plugs and receptacles for Eaton rackmount PDUs.

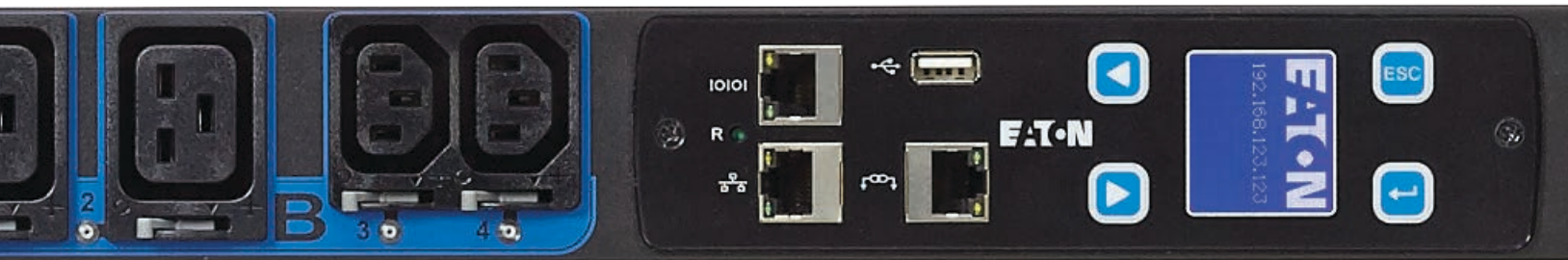

5-15R



5-15P



5-20R



5-20P



L5-20R



L5-20P



L5-30R



L5-30P



6-15R



6-15P



L6-20R



L6-20P



L6-30R



L6-30P



L14-30R



L14-30P



16A



32A



R indicates receptacle

P indicates plug











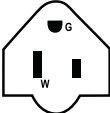
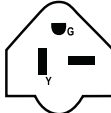

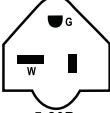

L indicates locking plug or receptacle

## General PDU environment specifications







- **Operating temperature** is 0 to 60°C (32 to 122°F)
- **Storage temperature** is -40 to 70°C (-40 to 158°F)
- **Altitude maximum** is 10,000 ft.
- **Relative humidity** is 95% max non-condensing

[Eaton.com/PDU](http://Eaton.com/PDU)

# Standard NEMA plugs

 <p>5-15P 120V 15A 1 phase straight blade</p>	 <p>6-20 208V 20A 1 phase straight blade</p>	 <p>L21-20 120/208V 20A, 3 phase wye twist lock</p>	 <p>L22-20 277/480V 20A 3 phase wye twist lock</p>
 <p>5-20 120V 20A 1 phase straight blade</p>	 <p>L6-20 208V 20A 1 phase twist lock</p>	 <p>L21-30 120/208V 30A 3 phase wye twist lock</p>	 <p>L22-30 277/480V 30A 3 phase wye twist lock</p>
 <p>L5-20 120V 20A 1 phase twist lock</p>	 <p>L6-30 208V 30A, 1 phase twist lock</p>	 <p>L15-20 208V 20A 3 phase delta twist lock</p>	 <p>L25-30 240V 30A 1 phase twist lock</p>
 <p>L5-30 120V 30A 1 phase twist lock</p>	 <p>L14-30 120/240V 30A 2 phase (split phase)</p>	 <p>L15-30 208V 30A 3 phase delta twist lock</p>	 <p>L26-30 240/415V 30A 3 phase wye twist lock</p>

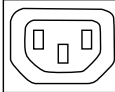

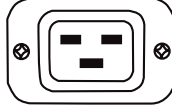



## IEC320

 <p>C13</p>	 <p>C14</p>	 <p>C19</p>	 <p>C20</p>
			
North American	15 amp	250 volts	
Europe	10 amp	250 volts	20 amp 16 amp
			250 volts



### The IEC advantage:

The IEC320 and IEC309 connectors described below are the most commonly specified. The IEC connector system is used throughout the world. By utilizing an Eaton PDU with the IEC connectors, you can attach the correct cable assembly for British, Australian, Continental European, North American and many other cable/connector configurations. This allows you to purchase and inventory one PDU for shipment anywhere in the world.

## IEC309

30A	60A	30A	60A	60A	60A
 <p>332P6 250V</p>	 <p>360P6 250V</p>	 <p>532P6 3ØY230/400V</p>	 <p>460P9 3Ø250V</p>	 <p>560P9 3ØY120/208V</p>	 <p>563P6 3ØY230/400V</p>

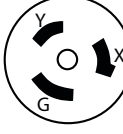
## Other

 <p>50A, 2P3W 250V CS8265</p>	 <p>50A, 3P4W 3Ø250V CS8365</p>
--	--



# Tour a configurable PDU

Configurable rack PDUs allow you to pick and choose what works for your environment.



**IEC outlet grips** are integrated into each outlet to secure plugs

**Alternating phases outlet by outlet** improves visual load balancing and reduces cable clutter

Traditional outlets are broken into branches along the length of the PDU and work on a per-branch basis.



Alternating phase outlets are grouped together along the length of the PDU and work on a per-outlet rather than per-branch basis.



**Three-way configurable inputs options:** input plug, input cord length and cord entry position



**Remotely power cycle equipment** by switching on/off individual outlets

**Mix and match IEC and NEMA outlets** across two configurable outlets modules to get up to 54

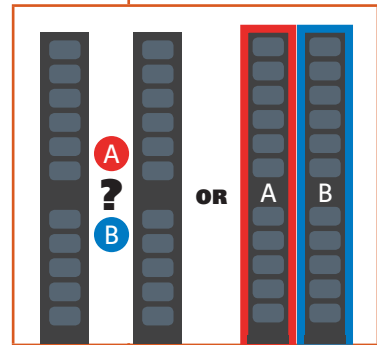

**Easily identify A/B feeds** with configurable colors

**Reduce infrastructure costs** by up to 87.5% using built in communication ports to daisy chain PDUs



**Circuit protection options** in a low-profile format that won't interfere with access to IT equipment inside a rack enclosure

# Gaining a full understanding of PDU technology

## How to select a PDU by business need

PDUs have a wide range of features and benefits. To find out which features will be the most valuable to you, you can start at the business need and consider PDUs that were built to address your particular challenges.

Model	Need	How
<p><b>Basic PDU</b></p> <p>Basic models, while lightyears ahead of legacy PDU products, are still only equipped with the primary features necessary to distribute electrical power and “get the job done.”</p>	<p><b>I want to:</b></p> <ul style="list-style-type: none"> <li>• <b>Effectively</b> distribute electrical power</li> <li>• <b>Organize</b> my power distribution strategy</li> <li>• <b>Simplify</b> load balancing</li> <li>• <b>Prevent</b> accidental plug disconnects</li> <li>• <b>Reduce</b> cooling costs and maintain full functionality in high temperatures</li> </ul>	<p><b>Look for a unit with features like:</b></p> <ul style="list-style-type: none"> <li>• <b>Outlet grip plug retention</b></li> <li>• <b>Color-coded outlet sections</b></li> <li>• <b>A low-profile form factor</b></li> <li>• <b>High operating temperature capabilities</b></li> </ul>
<p><b>Metered PDU</b></p> <p>Metered models have varied measurement functionalities and service enhancements that let you save time and money.</p>	<p><b>Yes, I want all that, but I also need to save time and money with the ability to:</b></p> <ul style="list-style-type: none"> <li>• <b>Optimize</b> power usage with highly accurate power monitoring</li> <li>• <b>Use</b> meter color-coded sections to control power utilization</li> <li>• <b>Remove</b> meters to make service pain-free and maintain uptime</li> <li>• <b>Gain</b> easy access to information, IP setup and troubleshooting</li> <li>• <b>Share</b> network connection/IP address for multiple PDUs</li> <li>• <b>Make</b> better deployment decisions with precise data and energy analysis through outlet-level measurements</li> <li>• <b>Transform</b> billing into revenue or utility discounts by measuring Level 3 PUE</li> </ul>	<p><b>Look for a unit with features like:</b></p> <ul style="list-style-type: none"> <li>• <b>One percent billing grade accuracy</b></li> <li>• <b>LCD pixel display</b></li> <li>• <b>Daisy chain capabilities</b></li> <li>• <b>Hotswap meter</b></li> <li>• <b>Phase and section metering, and measurement capabilities at the outlet-level</b></li> </ul>
<p><b>Managed PDU</b></p> <p>Managed models give you the most advanced power management and precision control that can empower your decision-making and eliminate the most risk.</p>	<p><b>Yes, I want all that, but I also need to reduce risk with the ability to:</b></p> <ul style="list-style-type: none"> <li>• <b>Remotely control</b> devices by powering on, off or rebooting individual outlets</li> <li>• <b>Control unauthorized use</b> of unused outlets</li> <li>• <b>Avoid onsite visits</b> with remote capabilities</li> <li>• <b>Group multiple power supplies</b> across the PDU to control all with a single action (i.e. save time when rebooting servers with two or more power supplies)</li> </ul>	<p><b>Look for a unit with features like:</b></p> <ul style="list-style-type: none"> <li>• <b>Outlet switching</b></li> <li>• <b>Turning off unused outlets</b></li> <li>• <b>Remote site management and group reboot for A/B feeds</b></li> </ul>
<p><b>High density PDU</b></p> <p>High density (HD) models include all the features you’ve come to expect from rack PDUs, with the additional benefits of configurability, improved outlet counts, and color chassis options.</p>	<p><b>Now that I can save time, save money, and reduce risk, I want to customize to fit my IT environment:</b></p> <ul style="list-style-type: none"> <li>• <b>Increase the number of outlets</b> within the same amount of space</li> <li>• <b>Reduce cord interference</b> within racks</li> <li>• <b>Eliminate cable clutter</b></li> <li>• <b>Better identify</b> potential unequal power distribution</li> </ul>	<p><b>Look for a unit with features like:</b></p> <ul style="list-style-type: none"> <li>• <b>Configurable circuit protection options</b></li> <li>• <b>Improved outlet count of up to 54 outlets</b></li> <li>• <b>Color-coded alternating phase outlets</b></li> </ul>

For help selecting the right PDU, visit [switchon.eaton.com/power101](http://switchon.eaton.com/power101) for a lesson from Professor Wattson.



## How to select a PDU by application type

Power distribution is needed in racks to properly connect servers, switches and other IT equipment, but beyond that, you must find out which type is best for your needs. Consider the application you are buying for to help determine which PDU model is right for you.

Application	What to look for
Small/medium business	<ul style="list-style-type: none"> <li>• Portfolio of 120V and lower power ratings (kVA)</li> <li>• Economical basic or metered input models</li> <li>• Advanced LCD pixel display for local monitoring</li> </ul>
Remote office/branch office	<ul style="list-style-type: none"> <li>• Portfolio of 120V and lower power ratings (kVA)</li> <li>• Reboot devices without local IT staff assistance</li> <li>• Control unused outlets to prevent unauthorized use</li> <li>• LCD pixel menu display simplifies setup</li> </ul>
Enterprise data center	<ul style="list-style-type: none"> <li>• Up to 208V three-phase 22kW for high density applications</li> <li>• Network monitoring of power usage and capacity at the outlet level</li> <li>• Save time by rebooting devices from the operations center</li> <li>• Measure for Level 3 power usage effectiveness (PUE)</li> <li>• Configure cord entry position and cord length for seamless box-to-rack transition</li> <li>• Simplify load balancing with alternating phase outlets</li> <li>• Easily distinguish between A/B power feeds</li> <li>• Configure up to 54 outlets or less for smaller racks</li> </ul>
Colocation service provider	<ul style="list-style-type: none"> <li>• Simplify load balancing with color-coded outlet sections</li> <li>• Control unused outlets to prevent unauthorized use</li> <li>• Measure for Level 3 PUE</li> <li>• Measure tenant power consumption to the outlet level for accurate billing to this degree of accuracy</li> </ul>



### HELPFUL HINT

#### Metered input vs. Metered outlet

Metered input includes a LCD display, easy serviceability and advanced measurement capabilities. Metered outlet allows you to monitor at the outlet level.

### HELPFUL HINT

#### Color is a distinguishing factor for high density PDUs

The PDU colors brighten up your IT environment and allow you to quickly identify A and B power feeds in a rack enclosure.



# Questions to consider when choosing a PDU

Before talking to a manufacturer or reseller, review these questions so you are prepared for the type of decisions you may need to make when evaluating a PDU.

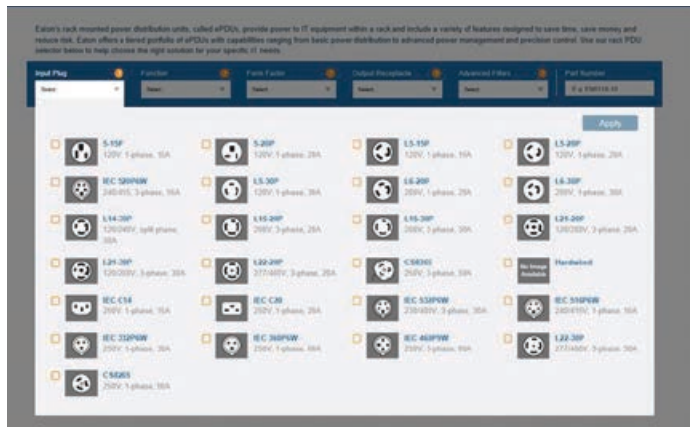

From input plugs to form factors and measurement features, Eaton's Rack PDU selector tool can help you find the right solution for your specific IT needs.

- What input plug and output receptacles do you need?**  
**See the images to the left to get an idea of your options, and go to [Eaton.com/RackPDUselector](https://www.eaton.com/RackPDUselector) for more details.**
  - Input plug (which type of outlet will you plug the rack PDU into)
  - Output receptacle (what will you be plugging into the rack PDU)
- How many different outlets do you need?**
- What kW power range will you require?**
  - 0-5 kW – Standard density
  - 5-10 kW – High density
  - 10+ – Ultra high density
- Where will you be installing the PDU?** If applicable, what size rack will you be installing the PDU and will it be horizontally or vertically mounted?
  - 0U (vertically mounted)
  - 1U (horizontally mounted)
  - 1U and 2U (horizontally mounted)
- What functionality do you need?**
  - Basic** – distribute power among your equipment
  - Metered input** – includes a LCD display, easy serviceability and advanced measurement capabilities
  - Metered outlet** – allows you to monitor at the outlet level
  - Managed** – includes remote monitoring and management capabilities to the outlet level
  - Hotswap** – enhances availability by facilitating UPS replacement without shutting down connected equipment
  - Remote emergency power off** – immediate and complete power off control from one button
  - Automatic transfer switch** – transfers power from primary to secondary source for power redundancy to equipment with a single power supply
  - High density** – has all the features and benefits of the managed PDU, with the same number of plug outlets as the basic PDU
- Why should I consider custom configurations?**
  - Save time** – customize the cord entry position and cord length for a seamless box-to-rack transition without any tool fumbling or cord wrestling
  - Save money** – enjoy even more outlets in the same space, with fewer PDUs needed to support your equipment's power needs
  - Reduce risk** – easily identify where power is coming from and where it's going with configurable colors that span the full PDU and alternating phase outlets

## Additional considerations to help you choose a rack PDU:

- Do you want the ability to daisy chain? How many units?
- Do you want to secure plugs with integrated IEC outlet grips?
- Do you want environmental monitoring capabilities?
- What input cord length will you require?
- Do you need circuit breakers?
- Do you need the unit to be TAA compliant?

# The history of rack PDUs

Before rack PDUs had the capabilities they do today, people often wondered what to do with them. Even IT pros found alternative uses for the basic power strips by using them as pretend light sabers or the occasional hiking stick. Only kidding, of course. But here, are some light-hearted but true facts on the evolution of the PDU as is related to other technology in pop culture.



EVOLVE  
OR DIE!

## In 1988 ...

The same year the first PDU patent was filed, the first online virus infected computers across the country. According to its creator, the virus was not written to cause damage, but to gauge the size of the Internet.

## In 1993 ...

When Pulizzi (now Eaton) first launched the patented PDU at WESCON tradeshow, IT pros may have been distracted by the launch of a literal game-changer: id Software's massively popular first-person shooter game Doom.

## In 2000 ...

When Pulizzi introduced remote reboot capabilities for PDUs, it helped IT pros save time and money by preventing costly site visits. Around the same time, USB drives helped IT pros save space by ditching their floppy discs.

## In 2001 ...

When the vertical PDU was introduced, IT pros could more effectively organize their infrastructure by mounting it at the back of the rack. After this, they could then visit the very first Apple stores in McLean, Virginia, and Glendale, California.

## In 2011 ...

For the first time, new LCD displays on Eaton's rack PDUs made it easy to color-code outlets. Apple's voice-activated personal assistant Siri made it easier to get directions, check scores and predict the weather.

## In 2014 ...

Eaton introduced a patent-pending grip outlet for its rack PDU to hold standard plugs in place. In web history, 2014 will forever be known as the year HTML 5 was introduced, replacing the standard HTML 4 that had been in place since 1997.

## In 2018 ...

Eaton launched a high density PDU line designed with advanced configurability, improved outlet counts of up to 54 outlets, and 11 color chassis options.

### HELPFUL HINT

We pitted 16 of the sweetest rack PDU features against each other and left the voting to the Spiceworks community.

With more than 167 survey submissions, the IT pros' most beloved feature was remote site management. Why?

They said they enjoy "anything that will make daily tasks more simple."

Follow us at [Spiceworks.com/Eaton](https://Spiceworks.com/Eaton).

Fun fact!

PDU throne



PDUs can help you be the ruler of your IT realm.

Eaton has been in the PDU business for some time, and recently put left over and obsolete PDUs to some creative use. We teamed up with a local Raleigh, NC artist to create this PDU throne as a shout out to one of our (and IT's) favorite shows.

[Spiceworks.com/Eaton](https://Spiceworks.com/Eaton).

# Typical PDU configurations with UPS models

## Recommendations for improved reliability

In traditional power designs, you may have one UPS supporting your servers, switches and storage devices. In this type of environment, you are prone to having to shut down your equipment during a power failure, UPS maintenance or UPS replacement.

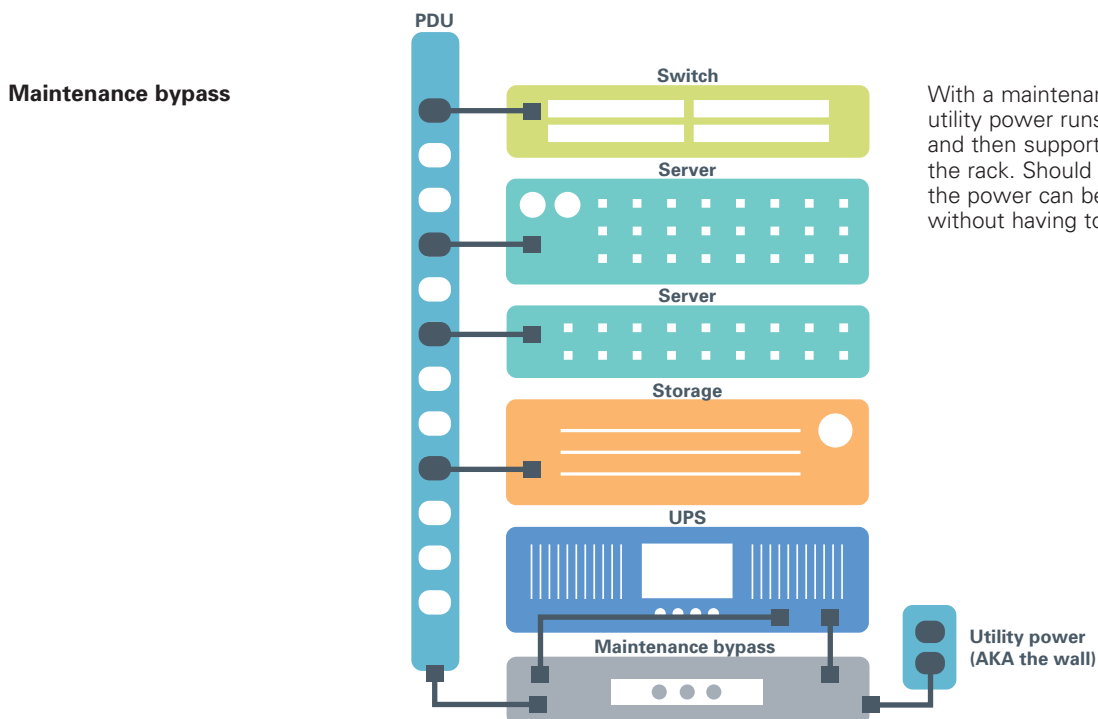
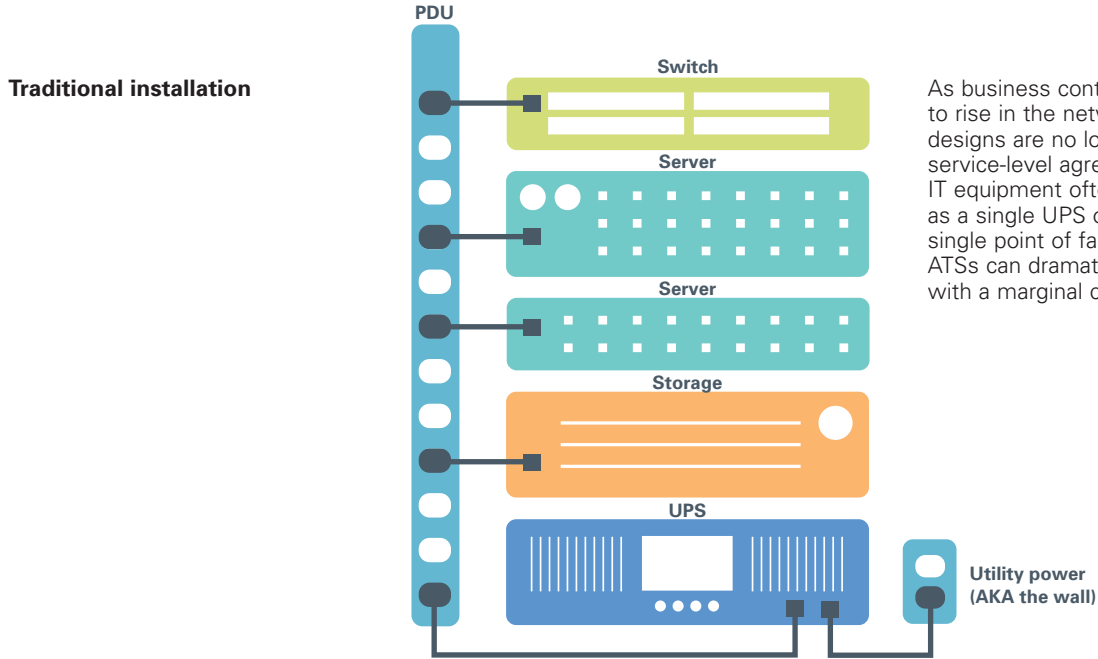



Eaton ATS models:



- 1 Graphical LCD (available on the 15- and 20-amp models) signifies which source is being output (30-amp models have a static display for identifying the source)
- 2 Test button can be used to manually force transfer
- 3 Network card supports IPv6 and provides remote monitoring capabilities via web browser or SNMP

Remotely monitor alerts, provide redundant power and keep mission critical applications running with this reliable and easy-to-use solution. [Eaton.com/eATS](http://Eaton.com/eATS).

Dual feed, dual UPS

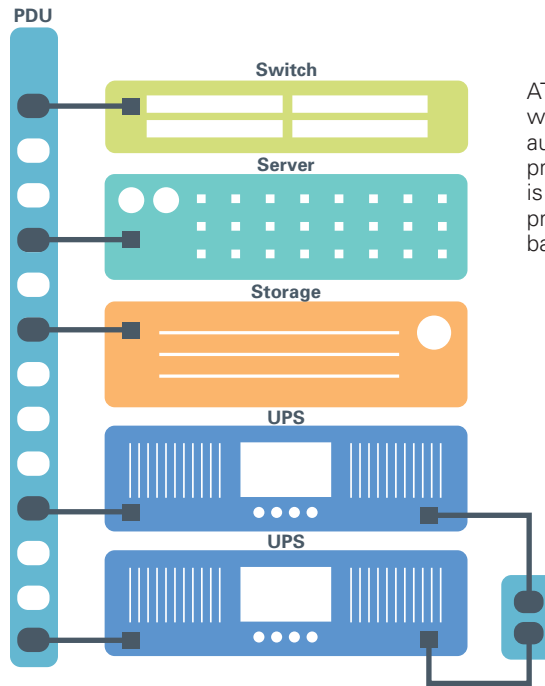

ATSs provide power redundancy to equipment with only one power supply. The ATS automatically transfers the power from a primary source to a secondary source if there is a problem with the primary. Once the primary source is restored, power transfers back through it.

Dual feed, single UPS

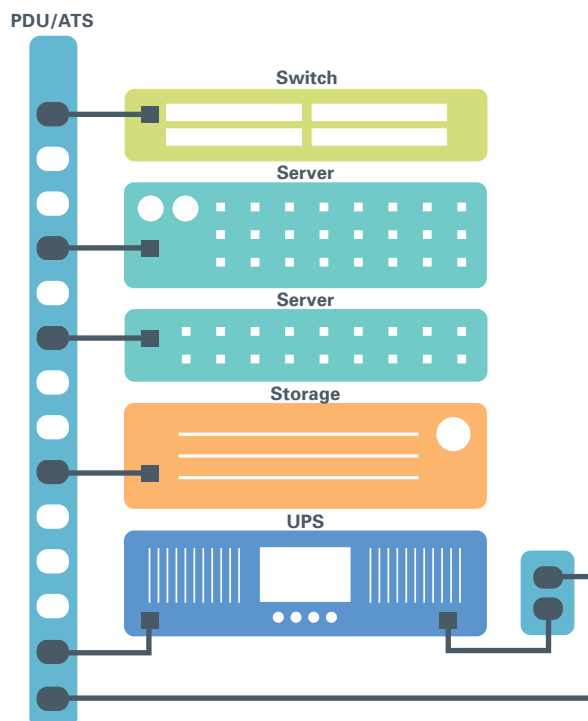

NICE SOLUTIONS, BUT I BELIEVE BACON CURES EVERYTHING!



# Power planning for non-traditional environments

## Are you managing a converged or hyperconverged infrastructure with non-traditional or condensed network elements?

Even if you are not deploying a traditional rack configuration, there are still validated power infrastructure designs you should consider in condensed converged and hyperconverged infrastructures.

Converged and hyperconverged infrastructures operate with fewer components, which means backup power and environmental monitoring, management and control related to power is much more vital.

Rack PDUs are an important element to power planning in these integrated environments. Follow the plans below to properly plan your environment.

### Power planning

- **Gather basic information** about the site where the hyperconverged solution will reside
- **Answer these questions** to confirm UPS and PDU selection:
  - > **What voltage is used?**
  - > **Is power available as a single- or three-phase source?**
  - > **What types of power input plugs are used?**
- **For dual power supplies in small deployments:** connect the nodes and switches to one PDU and then to the UPS for power protection.
- **For larger deployments:** use two rack PDUs for redundancy. Plug each rack PDU into a different load segment (group of receptacles that can be independently controlled) of the UPS.

Eaton, as an example, provides configuration recommendations and validated reference designs with key partners to deliver significant value when power planning and implementing.



The main players in the space have chosen to partner with power management providers to develop integrated solutions and product lab-validated designs.

To see how Eaton equipment works with converged and hyperconverged solutions, visit:

[Eaton.com/Cisco](http://Eaton.com/Cisco)

[Eaton.com/NetApp](http://Eaton.com/NetApp)

[Eaton.com/Simplivity](http://Eaton.com/Simplivity)

[Eaton.com/EMC](http://Eaton.com/EMC)

[Eaton.com/Nutanix](http://Eaton.com/Nutanix)

[Eaton.com/VMware](http://Eaton.com/VMware)

DOES THIS MEAN MORE TIME AWAY FROM THE OFFICE?



Companies are continually shifting away from owning their own data centers and are instead outsourcing their IT management to colocation and cloud-service providers, in order to drive increased flexibility, efficiency and reliability.

Hyperconverged platforms and software-defined networking are main objectives for data centers and IT infrastructures to save costs and reduce the risk of downtime.

Sample reference designs:

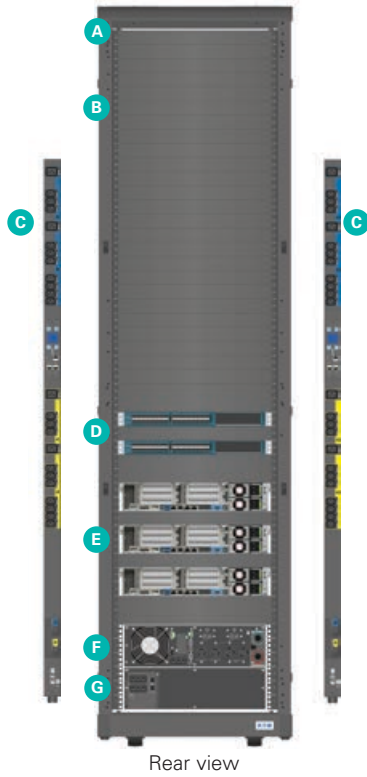

Rear view

Small footprint using HX220c M4 nodes (3-node minimum)

- A** Eaton 42U enclosure
- B** Eaton blanking panels
- C** Eaton managed ePDU G3
- D** Cisco UCS 6248UP 48-port fabric interconnect
- E** Cisco HX 220c M4
- F** Eaton 9PX rackmount, 2700 Watt, 2U UPS
- G** Eaton external battery module for 9PX UPS, 2U

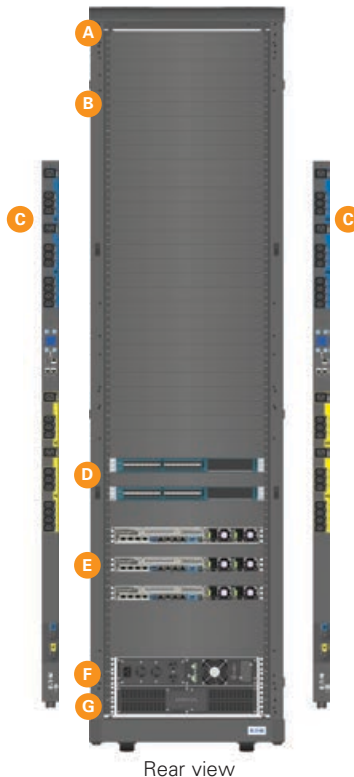

Rear view

Capacity-intensive cluster using HX240c M4 nodes (3-node minimum)

- A** Eaton 42U enclosure
- B** Eaton blanking panels
- C** Eaton managed ePDU G3
- D** Cisco UCS 6248UP 48-port fabric interconnect4
- E** Cisco HX 240c M4
- F** Eaton 9PX, 4500 Watt, 3U UPS
- G** Eaton external battery module for 9PX UPS, 3U

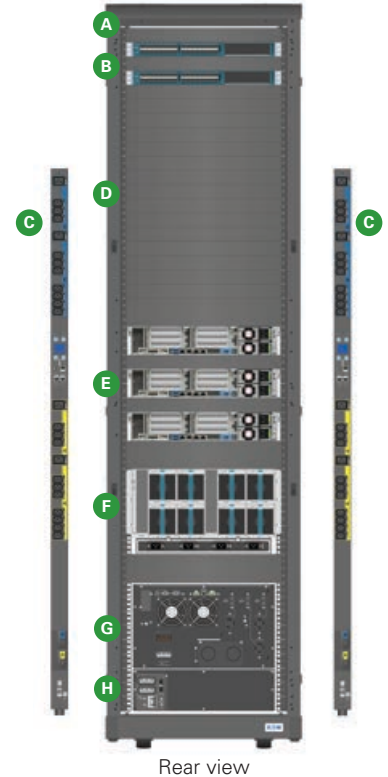

Rear view

Compute-intensive hybrid cluster using HX240c M4 nodes (3-node minimum)

- A** Eaton 42U enclosure
- B** Cisco UCS 6248UP 48-port fabric interconnect
- C** Eaton managed ePDU G3
- D** Eaton blanking panels
- E** Cisco HX 240c M4
- F** Cisco UCS B200 M4 Blade-Series servers
- G** Eaton 9PX, 7200 Watt, 6U UPS
- H** Eaton external battery module for 9PX UPS, 3U

\*For best reliability, add a second UPS for redundancy



# PDU software capability

## There are a number of management tools available to IT professionals

Software is no longer seen as an “add-on” element; it is seen as the backbone to connected power infrastructures. When it comes to your rack PDU, you will want remote access at the very least. The more complex your network closet, campus or enterprise is, the more remote access and control you will want your software to grant you.



1.

**Network connectivity** allows you to see the status of your PDU and remotely reboot or turn outlets and sections on/off from a web browser. This is the most basic form of monitoring, and typically an included feature. Using a web browser may be a good choice for small, standalone environments with 1-25 rack PDUs.

2.

**Environmental monitoring probes** are a connectivity device that enables you to collect temperature and humidity readings in the rack environment and monitor the environmental data via the onboard LCD screen or remotely using a Telnet connection or standard web browser. You can also monitor the status of two contact closure devices, such as door switches.



3.

### Eaton Intelligence Platform

The Eaton Intelligence Platform works to automate, monitor, visualize and predict problems before they strike. This solution is ready to take on the unique challenges you face within your IT environment by empowering you to:

- Make tasks simpler via advance alerts and automated resolution
- Make data actionable through faster interpretation and analysis
- See beyond power consumption through 3D infrastructure visualizations
- Predict power component failure with cloud-based analytics

As your environment scales, so does Eaton. Whether yours is a small deployment of UPS units and rack PDUs, a sophisticated data center housing thousands of servers and millions of datasets, or anything in between, our platform is versatile enough to change with you.

The Eaton Intelligence Platform helps you see what's coming today and adapts to serve for what's ahead.

UGH! EATON HAS GIVEN YOU ALL THE CONTROL!



# Power utilization

While not a one-day job for most, your environmental footprint (and possibly physical footprint) will be much better off as an end result.

## Keep your network alive and kicking

Many people are unaware that their servers are running at zero to 15 percent capacity, but according to **National Geographic**, “up to 30 percent of them are drawing power without actually doing anything.” An underutilized server is often referred to as a zombie server, and it becomes a very costly issue in IT.

In most cases, underutilized servers are consuming power, yet providing no benefit to users. This may not sound worrisome if you’re dealing with one or two servers, but your mind may change after calculating the annual cost in wasted energy. Unless your data center is based in a state where power is considered cheap, you are likely paying quite a bit for this loss. According to the **Wall Street Journal**, 10 million zombie servers worldwide use up power roughly equal in total to eight large power plants.

## How do zombie servers emerge?

Zombie servers can be a result of updating equipment or virtualizing your environment and not removing the old, now unused, units. Or, you may have started an expansion project that required more units, but the project got derailed and the units remained in place. Are you waiting for the day you will need that extra capacity? No matter what your situation is, it’s time to change this way of thinking and prevent zombie servers from eating your energy.

## What do we do to stop the spread of undead machines?

If you are being scrutinized for underutilization, it’s time to look at improving network efficiency to allow for significant cost savings and business growth. Everyone is susceptible to these threats, but with a good grasp of what’s going on at the rack level, you are capable of preventing equipment from working too hard.

## Your PDU can help you survive the zombie server outbreak.

Look for PDUs with advanced functionality to measure from the outlet level. Granular insights from the outlet level will allow you to get control of your PUE. With Level 3 PUE measurement, you know what is drawing power and are empowered to strategically reconfigure your space and to better utilize your equipment. This is a useful tool to IT managers trying to reduce energy consumption and identify zombie servers.

### Start here:

- Take inventory.
- Determine how often the network utilizes each server.
- Don’t wait. Pull the plug on those zombie servers.
- If you aren’t virtualized, consider it.
- Adopt a scalable approach.

TIME TO BRING ME AND YOUR SERVERS BACK TO LIFE!



PUE measurement	Level 1: Basic	Level 2: Intermediate	Level 3: Advanced
IT equipment energy	UPS outputs	PDU outputs	IT equipment input
Total facility energy	Utility inputs	Utility inputs	Utility inputs
Measurement intervals	Monthly/weekly	Daily/hourly	Continuous (15 minutes or less)

To obtain Level 3 PUE, you must take measurements at the IT equipment level in intervals of at least 15 minutes.



Rack PDUs can offer advanced PUE measurement.



# Spilling the beans on coffee & PDUs

## A harmonious blend

**Cappuccino, Frappuccino, Americano or Irish.**

New coffee trends and terminology can turn a simple cup o' joe into a confusing ordering frenzy. While your hipster nephew may be overly passionate about his Grande Soy Misto, others of us are just trying to get our caffeine fix for the day. So, we did you a favor. We're relating the complex caffeine industry to compelling features of rackmount PDUs. Here's the infographic you never knew you needed.

### 1 CONVENIENCE: Better latte than never

Grab a cup of brew and rest easy knowing you can manage your PDUs with remote monitoring. Saving time from eliminating those on-site visits has never sounded so good.



### 2 PERFORMANCE: Espressily for you

How much caffeine a day do you need to perform? As much espresso that can fit in your cup, we presume. As you ask yourself how many PDUs you need for your IT environment, consider the efficiency of Eaton's high density (HD) PDUs, which offer custom configurations and up to 54 outlets.

### 3 PERSONALIZABLE: Make it brew-tiful

Like a savory steamed latte, you can personalize your PDUs, too. Whether your alma mater color palette or your favorite childhood hue, choose from 11 colors to brighten up your space with the HD rack PDU.

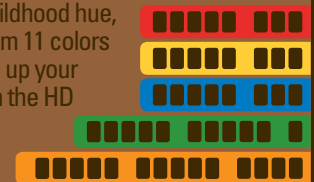

### 4 PROTECTION: The daily grind

Spilling coffee is a morning foul. And so is an accidental disconnect of your PDU outlet. With integrated IEC outlet grips, you can easily secure your PDU plugs to avoid power disruption to your IT equipment.



### 5 RE-ENERGIZE, REBOOT!

Based on answers from over 4,000 IT pros, we've heard the worst part of the job is 'running out of coffee'... so we know it's important to keep your cup full. Just as important as the caffeine kicking in, is being able to reboot your IT equipment when necessary. Managed PDUs offer outlet-level on/off control.



### 6 OPTIMIZATION: Have a latte on your mind?

Do some of your best thinking over coffee? With over 65,000 total combinations, you can optimize PDUs for your IT environment. And optimize those caffeine levels while you're at it.



### 7 DEPENDABLE: Service matters

No one likes that snobby barista that butchers your four-letter name. Customer service matters. Like the rich fragrance that enhances a great cup of coffee, a longer-than-industry standard warranty helps you enhance your operation.



### 8 CONFIGURABLE: Brew your own PDU

Grinding your own coffee beans can be essential to achieving the perfect cup of coffee.

Whether your palate prefers a light cinnamon roast, a medium nutty aroma or maybe a dark smoky zest, we fit the basic, metered or managed PDU to your IT needs.

See how you can configure your own PDU [here](#).



For more information about Eaton's rack PDUs, visit [Eaton.com/ePDUG3](http://Eaton.com/ePDUG3)



I WILL DISTRIBUTE  
MY LEARNINGS  
SO YOU, TOO, CAN  
MASTER POWER.

For more information about Eaton's rack  
PDU offerings, visit [Eaton.com/epdu](https://www.eaton.com/epdu)

**Eaton**  
1000 Eaton Boulevard  
Cleveland, OH 44122  
United States  
[Eaton.com](https://www.eaton.com)

© 2019 Eaton  
All Rights Reserved  
Printed in USA  
MZ155004EN / GG  
November 2019

Eaton is a registered trademark.

All other trademarks are property  
of their respective owners.

Follow us on social media to get the  
latest product and support information.

