

Eaton's guide to surge suppression

Applications notes



Powering Business Worldwide

Contents

Description	Page
Summary of applicable UL® and IEEE standards for surge protection devices	4
High-resistance grounding and wye or delta surge protection devices.....	9
Surge current per phase (industry definition)	10
Facility-wide surge suppression	10
Debunking the surge current myth, “Why excessive surge current ratings are not required”	11
Surge arrester vs. surge suppressor	12
Benefits of hybrid filtering in surge protection devices	14
Factory automation (PLCs) and their need for surge suppression.....	16
Surge protection devices with replaceable modules	17
Why silicon avalanche diodes are not recommended for AC powerline suppressors	18
Surge protective device frequently asked questions	20

Why Eaton?

As a premier diversified industrial manufacturer, Eaton Corporation meets your electrical challenges with advanced electrical control and power distribution products, industrial automation, world-class manufacturing, and global engineering services and support. Customer-driven solutions come in the form of industry-preferred product brands such as Cutler-Hammer®, MEM®, Holec®, Powerware® and Innovative Technology®.

Eaton has an extensive family of surge protective devices (SPD) for any facility or application. Using our Cutler-Hammer, Powerware and Innovative Technology branded products will ensure that the quality of power required to maximize productivity in today's competitive environment will be supplied in the most reliable, safe and cost-effective manner. Eaton has developed specific surge protection solutions for commercial, industrial, institutional, telecommunication, military, medical and residential applications—both for North America and throughout the world.

Cutler-Hammer

Eaton's Cutler-Hammer SPDs are designed to be fully integrated into new switchgear and new panels for the closest possible electrical connection. When installing a surge suppressor, it is important to mount it as close to the electrical equipment as possible in order to keep the wiring (lead length) between the electrical equipment and the suppressor as short as possible. As such, Eaton was the first to introduce the Direct-On™ bus bar connected SPD that provides customers with the lowest system let-through voltage at the bus bar when compared to traditional cable connected surge protectors. By utilizing a direct bus bar connection, Cutler-Hammer SPDs achieve the industry's lowest let-through voltage to effectively suppress both high and low energy transient events and

provide protection for all connected electronic loads. This design provides superior suppression ratings and eliminates poor performance that result from poor cable connections and long lead lengths. Integrated transient voltage surge suppression (TVSS) is the number one choice for surge suppression in new-construction applications.

In addition to the extensive integrated SPD offering, the Cutler-Hammer SPD product line includes a wide variety of surge current ratings, monitoring features and external enclosure options. The Cutler-Hammer SPDs are available from authorized Cutler-Hammer electrical wholesalers. For information on Eaton's Cutler-Hammer SPD product line, please visit www.eaton.com/tvss.

Powerware

Lightning and other transient voltage and current-producing phenomena are harmful to most UPS equipment and electronic load equipment connected to the UPS. For example, the transient may reach the critical load via an unwanted activation of an unprotected static-switch bypass path around a UPS. Therefore, it is recommended practice that both the input circuit to the UPS and the associated UPS bypass circuits (including the manual maintenance bypass circuit) be equipped with effective Category "B" surge protective device, as specified in IEEE Std. C62.41-1991. Low-inductance connections should be employed for this protection.Ⓞ

Eaton's Powerware surge protective devices can be fully integrated into power distribution units (PDUs), and are designed to meet the demanding needs of the same mission-critical applications and facilities that utilize Powerware uninterruptible power systems (UPS). Powerware surge protection devices are available in a wide variety of surge current ratings, monitoring features and enclosure options.

Ⓞ Source: IEEE RDP Std. 1100-1999.

For information on Eaton's Powerware SPD product line, please visit www.powerware.com/tvss.

Innovative Technology

Since 1980, Innovative Technology products have solved the most difficult electrical transient problems for business, industry, government and defense sectors. Innovative Technology products and Technologies protect electrical, data, telecom circuits, and electronic equipment from the effects of lightning-induced voltages, external switching transients, and internally generated electrical transients.

As a part of Eaton's electrical business since 2003, Innovative Technology SPD products are even better positioned to deliver state-of-the-art customer solutions. Innovative Technology products are designed to be the most rugged and durable SPDs in the market. Based on extensive proven field performance, Innovative Technology was the first to offer a 20-year full replacement warranty. Electrical engineers around the world recognize Innovative Technology as a leader in the SPD industry. A leading research company in a survey of over 10,000 users rated Innovative Technology number one in both product quality and service.

Innovative Technology SPD products are available in a wide range of voltages (including voltages up to 5 kV), surge current ratings, monitoring features and enclosure options.

For information on Eaton's Innovative Technology products, please visit www.itvss.com.

Summary of applicable UL and IEEE standards for surge protection devices

TABLE 1. STANDARD DESCRIPTIONS

Standard (Current revision date)	Purpose of standard/comments
UL 1449 (1987)— Transient voltage surge suppressors (TVSS)	<ol style="list-style-type: none"> 1. Safety test (constructed of approved components in a safe manner). 2. Suppressed voltage rating (let-through voltage using the IEEE C62.41 C1 test wave). Other IEEE recommended waveforms such as the C3 and B3 Ringwave are not tested by UL. ①
UL 1449 (2nd Edition 1996)	<ol style="list-style-type: none"> 1. Additional safety tests. Test for other standards used to improve safety of products. 2. Surge test. Let-through voltage tested at lower current than 1st Edition. 10 kA (IEEE Cat. C3) used for the first time; however, it was used only to see if products fail safely.
UL 1449 (2nd Edition 2007)	<ol style="list-style-type: none"> 1. Stringent new safety requirements. New tests subject TVSS units to prolonged AC overvoltage conditions to ensure safe failure modes 2. UL label changes to the wording of the short circuit current rating. 3. New Testing at 10, 100, 500 and 1000A and system voltage were added to ensure the units fail in a safe manner.
UL 1449 (3rd Edition 2009)	<ol style="list-style-type: none"> 1. TVSS will now be referred to as SPD (surge protective devices). 2. UL 1449 is now ANSI/UL 1449. 3. Addition of four types of SPDs to cover surge arrestors, TVSS, surge strips and component SPDs.
UL 1283 (1996)— Electromagnetic interference filters	This safety standard covers EMI filters connected to 600V or lower circuits. The UL 1283 is a safety standard and does not include performance tests such as MIL-STD-220A insertion loss or Cat. B3 Ringwave let-through voltage tests.
UL 497, 497A, 497B	Safety standard for primary telephone line protectors, isolated signal loops and surge protection used on communication/data lines. No performance tests conducted for data/communication lines.
IEEE C62.41.1 (2002)	<i>IEEE Guide on the Surge Environment in Low-Voltage AC Power Circuits.</i> This is a guide describing the surge voltage, surge current, and temporary overvoltages (TOV) environment in low-voltage [up to 1000V root mean square (Rms)] AC power circuits.
IEEE C62.41.2 (2002)	IEEE-recommended practice on characterization of surges in low-voltage AC power circuits. This document defines the test waves for SPDs.
IEEE C62.45 (2002)	Guide on surge testing for low voltage equipment (ANSI). This document describes the test methodology for testing SPDs.
IEEE Emerald Book	Reference manual for the operation of electronic loads (includes grounding, power requirements, and so on).
NEMAT LS-1	NEMA Technical Committee guide for the specification of surge protection devices including physical and operating parameters.
NECT	National Electrical Code Articles 245, 680 and 800.
NFPAT 780	Lightning protection code recommendations for the use of surge protection devices at a facility service entrance.

① UL 1449 does not require a maximum surge current test.

Underwriter laboratories— UL 1449 (Revision 7-2-87), “Transient voltage surge suppressors (TVSS)”

UL 1449 is the standard for all equipment installed on the load side of the AC electrical service and throughout the facility for AC distribution systems. This includes both hardware and plug-in products. To obtain a UL listing, the suppressor must meet the required safety standards and pass a duty cycle test. In addition, UL conducts a let-through voltage test on the suppressor and assigns a suppressed voltage rating (SVR). UL 1449 ratings represent a component rating and not the actual let-through voltage of the

electrical distribution system (i.e., UL 1449 does not include the effects of installation lead length and overcurrent protection). A duty cycle test is based on a 26-shot withstand test. The UL test uses waveforms similar to those recommended in IEEE 62.41. To pass UL 1449, the TVSS unit must withstand the duty cycle test and not degrade by more than 10% from its initial let-through voltage value.

All UL-listed TVSS equipment displays the SVR rating for each applicable protection mode. If this rating is not affixed to the TVSS, then one must assume the device is not UL 1449 listed.

Notes

UL 1449 Second Edition does not test a suppressor to other important test waveforms such as the IEEE Cat. C3 service entrance surge (20 kV, 10 kA) or the B3 Ringwave (6 kV, 100 kHz), the most common type of transient inside a facility.

UL does not verify the TVSS device will achieve the manufacturer’s published surge current ratings. NEMA LS-1 provides the guidelines for product specification.

Plug-in products are tested differently and cannot be compared to hardwired devices.

UL 1449 (1996 and 2007 2nd Edition)

Underwriters Laboratories standard for safety for transient voltage surge suppressors (UL 1449) is the primary safety standard for transient voltage surge suppressors (TVSS). This standard covers all TVSS products operating at 50 or 60 Hz, at voltages 600V and below.

The UL 1449 safety standard was first published in August of 1985. As TVSS products have evolved in the marketplace, the standard has been updated to ensure the continued safety of the increasing sizes, options and performance of new TVSS designs. The second edition of UL 1449 was published in 1996. The second edition of the UL 1449 TVSS standard was revised in February 2005 and required compliance by February 9, 2007. All TVSS products manufactured after February 9, 2007 must comply with the February update to the standard. A third edition of UL 1449 was published in September of 2006 with compliance required by October of 2009. This article relates to the latest revision of the second edition of UL 1449, which is currently in effect and is acceptable until October of 2009.

To obtain a UL listing, a suppressor must pass a series of tests designed to ensure it does not create any shock or fire hazards throughout its useful life. Each TVSS product is subjected to the following electrical and mechanical tests: leakage current, temperature, ground continuity, enclosure impact, adequacy of mounting, and many others. Each test evaluates a different function or potential failure mode of a TVSS. To obtain UL certification, the TVSS unit must pass all tests. Two of the most significant tests performed on a TVSS are the measured limiting voltage test and a series of abnormal overvoltage tests.

The measured limiting voltage test is used to assign each TVSS a suppressed voltage rating (SVR), which appears on all UL certified units. This rating takes the average let-through voltages of three 6000V, 500A combination wave impulses (IEEE 62.41 cat C1 test waves) and rounds up to the next highest standard SVR class set by UL. The standard SVR classes are 330, 400, 500, 600, 800, 1000, 1200, 1500, 2000, 2500, 3000, 4000, 5000 and 6000V. For example, a 401V average let-through voltage is rounded up to a 500V SVR. The test is conducted with six inches of lead length, (length of wire from TVSS to test equipment connection point). Let-through voltages are significantly affected by lead length. Therefore, a six-inch lead length is used to standardize the test. The SVR value allows some comparison from one TVSS to another, but does not represent an expected field installed let-through voltage since actual installed lead length will vary from installation to installation.

The last major series of tests are the abnormal overvoltage tests. The purpose of these tests is to ensure that the TVSS will not create a shock or fire hazard, even if the unit is misapplied or subjected to a sustained overvoltage event. TVSS are designed to prevent high energy, short duration (typically two milliseconds or less) transient voltages from causing damage to an electrical installation. TVSS are not designed to sustain long-term overvoltages. During the abnormal overvoltage test, the TVSS unit is subjected to a voltage higher than its normal operating voltage, typically near double the design voltage. The overvoltage test is performed with current limited to the following current levels: 10, 100, 500 and 1000A. Every mode of the TVSS is subjected to the abnormal overvoltage tests. The testing of each mode is sustained for up to seven hours. During this time, the TVSS cannot create a fire or shock hazard.

In addition to successfully passing all applicable tests, all UL-listed TVSS units must be suitably and plainly marked. These markings include name of the manufacturer, a distinctive catalog number, the electrical rating, short circuit current rating (SCCR), SVR, and the date or period of manufacture. The TVSS must also be marked with the words "transient voltage surge suppressor" or "TVSS," and is able to be additionally marked immediately following in parentheses with the words "(surge protective device)" or "(SPD)."

The best way to verify that particular TVSS unit is UL listed is to conduct a search on the UL Web site at www.ul.com. The certification category for TVSS is UL category code "XUHT." An alternate way to verify a vendor's listing is to call UL at 1-847-272-8800. A listed product provides a user with the confidence their TVSS unit will not create a shock or fire hazard during use.

UL 1283 electromagnetic interference filters

Surge suppressors must be listed (or recognized) under UL 1449. Those devices employing an EMI filter can also be complementary listed under UL 1283 to ensure the filter components are properly designed to withstand the required duty cycle and stress requirements. UL 1283 covers EMI filters installed on, or connected to, 600V or lower circuits. These filters consist of capacitors and inductors used alone or in combination with each other. Included under this requirement are facility filters, hardwired and plug-in devices. UL 1283 reviews all internal components and enclosures, insulating material, flammability characteristics, wiring and spacing, leakage current, temperature ratings, dielectric withstand and overload characteristics. UL 1283 does not include performance tests such as the MIL-STD-220A insertion loss test to determine the dB rating of the filter at the desired frequency (i.e., 100 kHz for hardwired AC power systems) or the let-through voltage test using the IEEE Cat. B3 Ringwave.

UL 1449 (2009 3rd Edition) UL 1449 3rd Edition is now ANSI/UL 1449. The change in designation helps the standard gain relevance in North America and brings it closer to the IEC standards. By becoming a national standard and forming a voting committee, the standard also ensures conformance to NAFTA. This revision changes the designation of the TVSS devices, from TVSS to Type 2 surge protective devices (SPDs). The SPD is used as an umbrella designation and includes all types of surge protective products. The "type" designation of the SPD will be determined based on the installation location within an electrical system. Some examples are surge arrestors (Type 1 SPD), cord connected TVSS (Type 3 SPD) and a new category of component SPD (Type 4 SPD). The last nomenclature modification is the change of SVR (suppressed voltage rating) to VPL (voltage protection level). The new VPL ratings are required to be displayed on the UL tags for the each SPD unit.

The revised standard includes some testing modifications that include tests for nominal discharge current, tests to determine VPL and measured limiting voltage at 6 kV/3 kA.

Data/communication line protectors (UL 497, 497A, 497B)

UL 497 is the safety standard for single or multi-pair Telco primary protectors. Every telephone line provided by a telephone operator must have an UL-approved T1 protector (gas tube or carbon arrester) in accordance with Article 800 of the National Electric Code (NEC).

A primary protector is required to protect equipment and personnel from the excessive potential or current in telephone lines caused by lightning, contact with power conductors and rises in ground potential. UL 497A applies to secondary protectors for communication circuits. Secondary protectors are intended to be used on the protected side of telecommunication networks (it assumes primary protectors are in place) that have operating Rms voltage to ground less than 150V. These protectors are typically used at the facility incoming service or other areas where communication circuits require protection. UL 497B applies to data communication and fire alarm circuit protectors (communication alarm initiating or alarm indicating loop circuits). This includes most dataline protectors in the electrical industry.

ANSI/IEEE C62.41 (2002) recommended practice on surge voltages in low voltage AC power circuits (ANSI)

This document describes a typical surge environment based on location within a facility, power-line impedance to the surge and total wire length. Other parameters include proximity, type of electrical loads, wiring quality and geographic location.

The document only describes typical surge environments and does not specify a performance test. The waveforms included in the document are meant as standardized waveforms that can be used to test protective equipment. Any statement where a manufacturer advertises that its "protector meets the requirement of," or is "certified to IEEE C62.41," is inappropriate and misleading.

Two selected voltage/current waveforms (see **Figures 1 and 2**) are identified as representative of typical electrical environments:

1. Combination wave: a unipolar pulse that occurs most often outside a facility (e.g., a lightning strike)
2. 100 kHz Ringwave: an oscillating waveform that occurs most often inside a facility

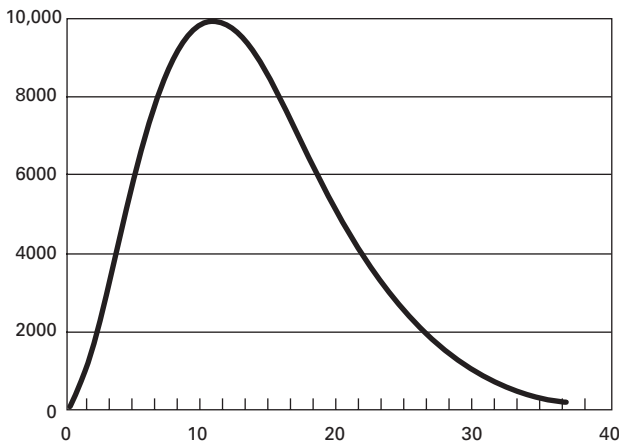

FIGURE 1. COMBINATION WAVE

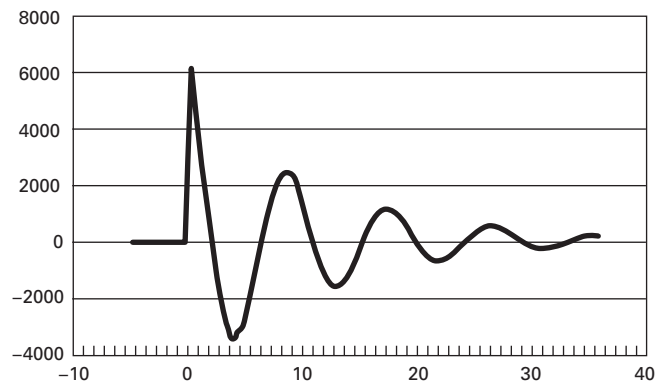

FIGURE 2. RINGWAVE

The amplitude and available energy of the standard waveforms are dependent upon location within a facility.

As shown in **Figure 3**, locations are classified into three categories:

Category A: outlets and long branch circuits

- All outlets at more than 10m (30 ft) from Category B
- All outlets at more than 20m (60 ft) from Category C

Category B: feeders and short branch circuits

- Distribution panel devices
- Bus and feeder distribution
- Heavy appliance outlets with "short" connections to service entrance
- Lighting systems in large buildings

Category C: outside and service entrances

- Service drops from pole to building
- Runs between meter and panel
- Overhead lines to detached building
- Underground lines to well pump

The Category C surges can enter the building at the service entrance. SPDs must be sized to withstand these types of surges when installed at switchgear or service entrance switchboard. The second variable used to classify the environment of a power disturbance is exposure. As shown in **Figure 4**, IEEE has defines three exposure levels that characterize the rate of surge occurrence versus voltage level at an unprotected site. The three exposure categories include:

- **Low exposure:** applications known for low lightning activity, little load switching
- **Medium exposure:** systems and geographical areas known for medium to high lightning activity or with significant switching transients or both
- **High exposure:** those rare installations that have greater surge exposure than those defined as low or medium

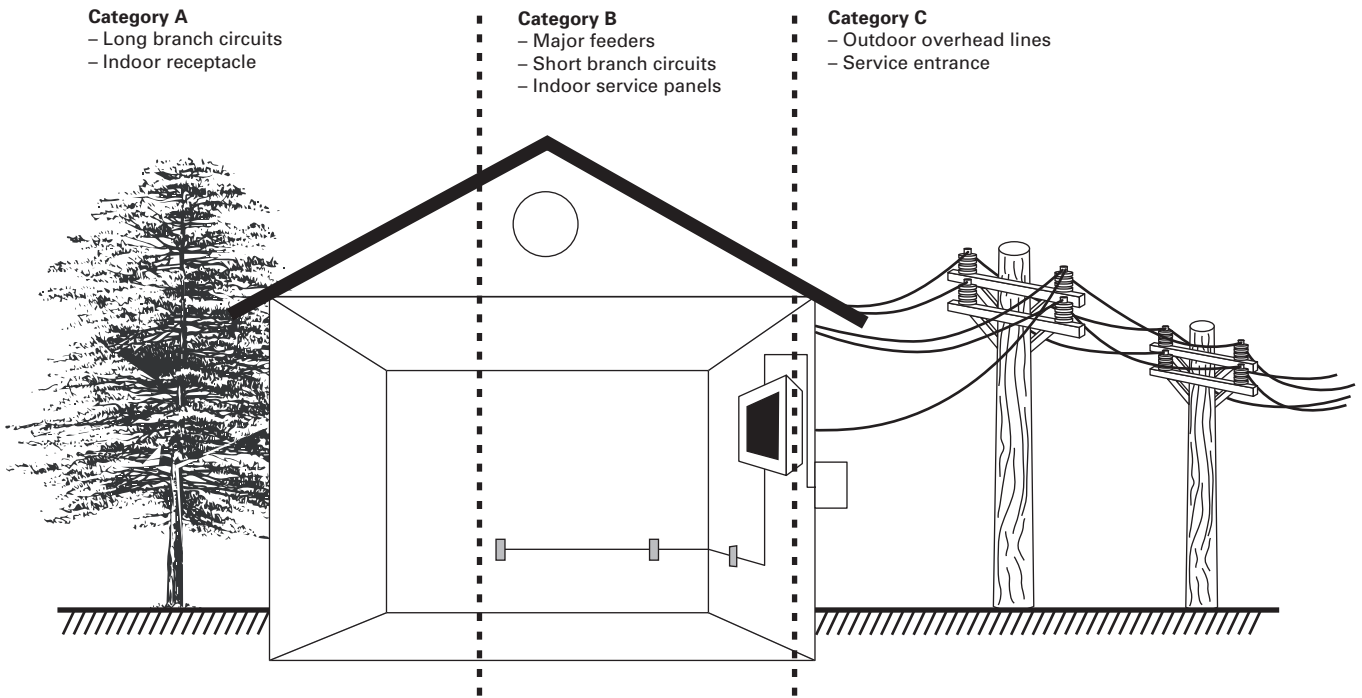

FIGURE 3. IEEE C62.41 LOCATION CATEGORIES

Isokeraunic maps provide a good baseline for evaluating lightning occurrence within a region.

Discussions with local utilities and other major power users combined with power quality surveys are useful for measuring the likely occurrences from load switching and power factor correction capacitors.

For each category and exposure level, IEEE has defined the test waveform that should be used by a specifier when determining performance requirements. For example, most SPDs installed at the main service panel after the meter are in a Category C environment. **Table 2** details the C62.41 test waveforms for categories A, B and C.

In the C62.41 (2002) document, special waveforms have been identified to address large banks of switching capacitors or the operation of fuses at the end of long cables. These situations warrant the consideration of additional waveforms where energy is greater than those stipulated for Category A, B and C environments.

Many specifiers are confused about the recommendations contained in C62.41. Often the document is misapplied because category environments and test waveforms are used as performance standards (e.g., “ability to meet C62.41”).

The C62.41 recommendations should be used for selecting specifications appropriate to the needs of a given designer or end user.

Number of surges per year exceeding surge crest of abscissa

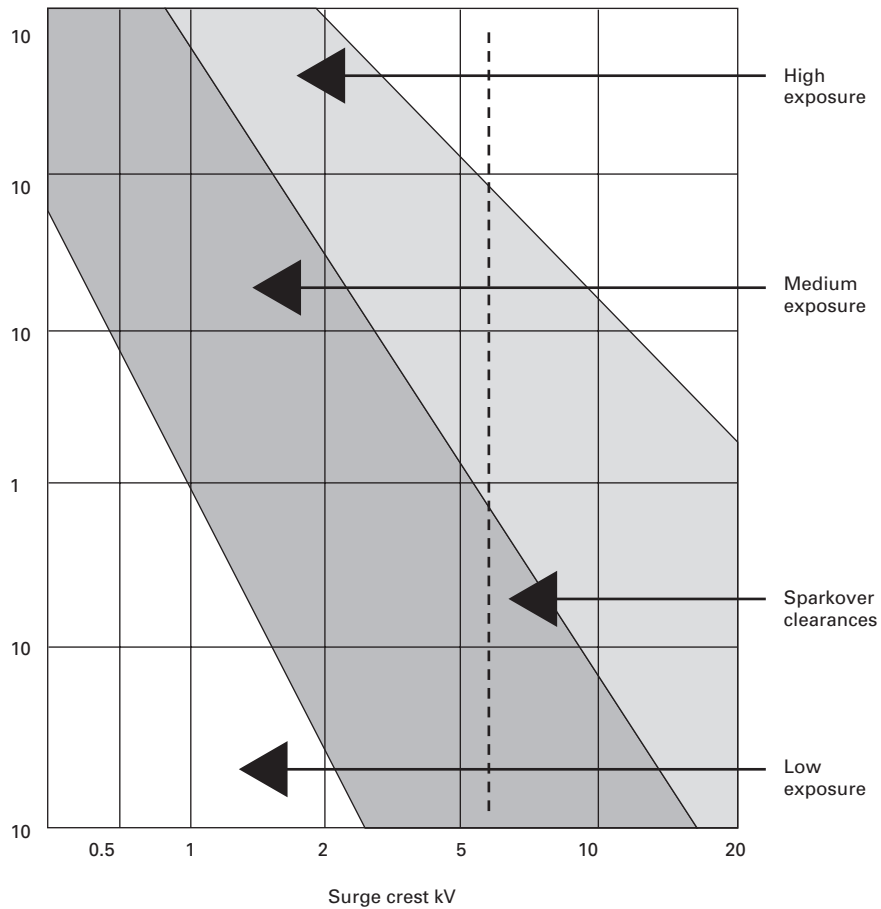

FIGURE 4. COMBINATION WAVE

IEEE C62.45 (2002)—Guide on Surge Testing for Equipment Conducted to Low Voltage AC Power Circuits

This document provides appropriate surge testing guidelines for equipment survivability, methods of test connection, surge coupling mode definitions, testing safety requirements and various theories of surge suppression techniques. The intent is to provide background information that can help determine if specific equipment or a circuit has adequate withstand capability.

An important objective of the document is to call attention to the safety aspects of surge testing. Signal and datalines are not addressed.

IEEE Std. 1100 (2005) Emerald Book Recommended Practice for Powering and Grounding Sensitive Electronic Equipment

This publication presents recommended engineering principles and practices for powering and grounding sensitive electronic equipment. This standard is the recommended reference book for facility-wide power quality solutions. The scope of this publication is to “recommend design, installation and maintenance practices for electrical power and grounding of sensitive electronic processing equipment used in commercial and industrial applications.”

The following sections apply to surge protection devices:

- Chapter 3 (particularly 3.4.2 and 3.4.3)
- Chapter 4 (particularly 4.2 and 4.4)
- Chapter 8 (particularly 7.2)
- Chapter 9 (particularly 8.6)

TABLE 2. IEEE C62.41 CURRENT/VOLTAGE WAVEFORMS FOR VARIOUS EXPOSURE LOCATIONS

CAT.	LEVEL	VOLTAGE (KV)	0.5µs X 100 KHZ RING WAVE CURRENT (A)	1.2 X 5µs (V) 8 X 20µs (A) COMBINATION WAVE CURRENT (KA)
A1	Low	2	70	—
A2	Medium	3	130	—
A3	High	6	200	—
B1	Low	2	170	1
B2	Medium	4	330	2
B3	High	6	500	3
C1	Low	6	—	3
C2	Medium	10	—	5
C3	High	20	—	10

NEMA® LS-1

This document is a specification guide for surge protection devices for low voltage AC power applications (less than 1000V). The document identifies key parameters and evaluation procedures for specifications. NEMA employed established references such as IEEE and UL guidelines. The following parameters are included in the LS-1 document:

- Maximum continuous operating voltage (MCOV)
- Modes of protection
- Maximum surge current per mode
- Clamping voltage (A3, B3 Ringwave, B3/C1 impulse, C3 impulse)
- EMI noise rejection (insertion loss)
- Safety UL approvals (including UL 1449, UL 1283)
- Application environment

NEMA LS-1 (and other organizations) do not recommend the use of Joule ratings or response time as a performance criteria for SPDs.

National Electrical Code (United States): NEC®—article 280, 285, 645 and 800 surge arrestors

The adequacy section of the code clearly states that compliance with the code will not ensure the proper equipment performance. This fact is often overlooked by end users/customers considering electrical designs from a low-bid perspective.

Article 280 covers the general requirements, installation requirements and connection requirements for surge arrestors installed on premises wiring systems.

Article 285 covers the general requirements, installation requirements, and connection requirements for transient voltage surge suppressors permanently installed on premise wiring systems.

Article 645 covers electronic computer/data processing Equipment and references National Fire Protection Association (NFPA) 75.6.4 regarding the protection of electronic computer/data processing equipment.

Article 800 reviews protection requirements (800-31), secondary protector requirements (800-32) and cable and protector grounding (800-40) for communication circuits.

National Fire Protection Association (NFPA)—780 lightning-protection code

NFPA 780 is the code for lightning protection systems and addresses the protection requirements for ordinary structures, miscellaneous structures and special occupancies, industrial operating environments, and so forth. The following paragraphs are related to surge protection: 3-21 surge suppression. Devices suitable for protection of the structure shall be installed on electric and telephone service entrances, and on radio and television antenna lead-ins.ⓐ

Note: Electrical systems and utilization equipment within the structure may require further surge suppression.

ⓐ Shall indicate a mandatory requirement.

High-resistance grounding and wye or delta surge protection devices

In today's manufacturing facilities, ground faults can wreak havoc on production and process equipment. These manufacturing facilities may have a high-resistance grounding (HRG) system. In an HRG system, a resistance, which is connected between the neutral of the transformer secondary and earth ground, is used that effectively limits the fault current to a low value current under ground fault conditions. Usually, the current is limited to 10A or less. As a result, the system will continue to operate normally, even under the ground fault condition.

Figure 5 depicts a system that has a resistance grounding scheme. In the case where surge suppression is required for a three-phase, four-wire wye system with a neutral ground resistance (NGR), a three-phase, three-wire delta SPD will want to be specified and used.

In a wye system, the neutral and ground are both located at the center, as shown in **Figure 6**. If the neutral is bonded to the ground, the system will remain unchanged under fault conditions.

In the case where the neutral is not bonded to ground and a fault condition is present, the ground will "move" towards the phase that has the fault.

Figure 7 shows a fault condition on phase C. The result is phase A to ground and phase B to ground are now at line to line voltage instead of line to neutral voltage. If a three-phase, four-wire wye SPD was installed in an application where the neutral was not bonded to ground and a fault condition occurred on one of the phases, the result would be SPD failure.

In today's electrical systems, with many different grounding systems and various voltages, determining which SPD voltage configuration to specify can be confusing. Following are several helpful guidelines to follow when specifying SPDs:

- Only apply a wye (three-phase, four-wire) configured SPD if the neutral is physically connected to the SPD and if the neutral is directly and solidly bonded to ground
- Use a delta (three-phase, three-wire) configured SPD for any type of impedance (resistive, inductive) grounded system
- Use a delta (three-phase, three-wire) configured SPD for a solidly grounded wye system where the neutral wire is not pulled through to the SPD location
- Use a delta (three-phase, three-wire) configured SPD if the presence of a neutral wire is not known

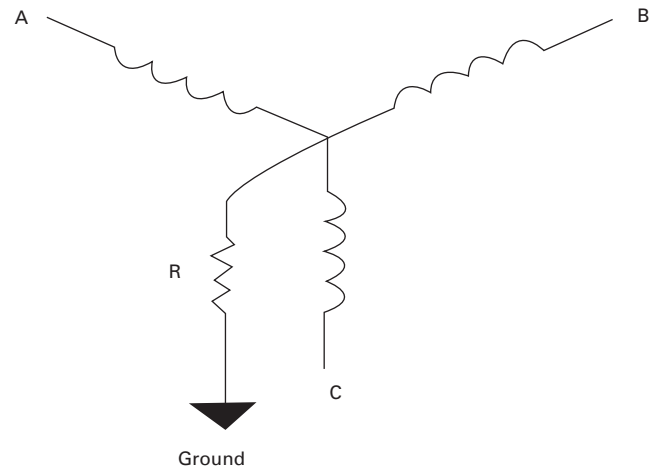

FIGURE 5. RESISTANCE GROUNDING SCHEME

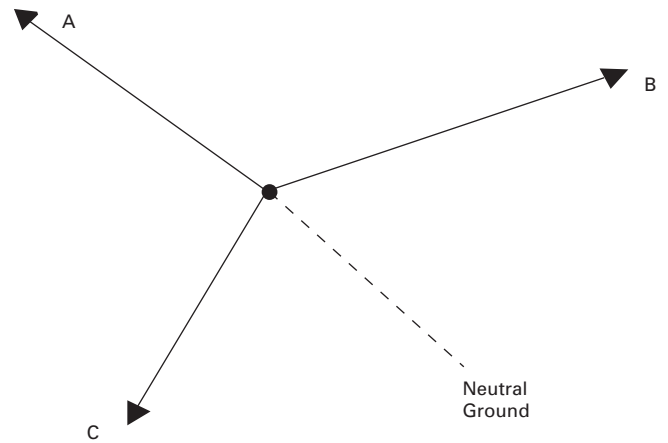

FIGURE 6. WYE SYSTEM

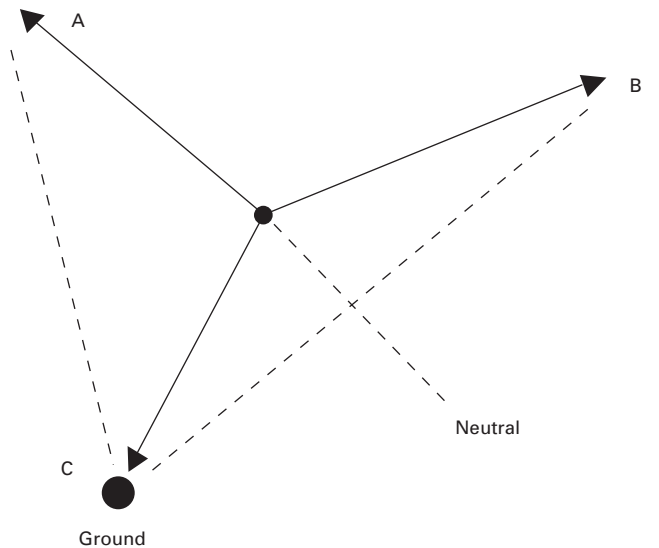

FIGURE 7. PHASE C FAULT CONDITION

Surge current per phase (industry definition)

Engineers/specifiers routinely install TVSS devices at the service entrance and key branch panels to protect sensitive microprocessor loads such as computers or industrial control devices from damaging surges and noise. These devices are available in a wide range of sizes to meet different application requirements. Suppressors located at the facility's service entrance must handle higher energy surges than those located at branch panels.

TVSS devices are classified by the unit's maximum "surge current" measured on a per phase basis. Surge current per phase (expressed as kA/phase) is the maximum amount of surge current that can be shunted (through each phase of the device) without failure and is based on the IEEE standard 8 x 20 microsecond test waveform.

As per NEMA LS-1, TVSS manufacturers are required to publish the level of surge protection on each mode. A delta system can employ suppression components in two modes (L-L or L-G). For wye systems, shunt components are connected L-G, L-N and/or N-Gs.

How to calculate "surge current per phase"

The per-phase rating is the total surge current capacity connected to a given phase conductor. For example in a wye system, L1-N and L1-G modes are added together because surge current can flow on either parallel path. If the device has only one mode (e.g., L1-G), then the per-phase rating is equal to the per-mode rating because there is no protection on the L1-N mode.

Note: N-G mode is not included in the surge current per-phase calculation.

Almost all suppressor manufacturers follow this convention. However, there are some companies who attempt to cause confusion by inflating their surge current ratings using a non-standard method for calculating surge current per phase. As shown below, the correct mode and phase ratings are displayed.

Summary

Surge current per phase (kA/phase) has become the standard parameter for comparing suppression devices. Most reputable manufacturers publish surge current ratings on a per-mode and per-phase basis. Some suppression manufacturers may hide surge current ratings or make up their own method to calculate surge ratings. Avoid manufacturers who do not clearly publish these industry standards—per-phase and per-mode surge capabilities.

Facility-wide surge suppression

As recommended by IEEE (Emerald Book 1992), TVSS units need to be coordinated in a staged or cascaded approach. IEEE provides the following recommendations:

"...For large surge currents, (transient) diversion is best accomplished in two stages: the first diversion should be performed at the service entrance to the building. Then, any residual voltage resulting from the action (of the suppression device) can be dealt with by a second protective device at the power panel of the computer room (or other critical load). In this manner, the wiring inside the building is not required to carry the large surge current to and from the diverter at the end of a branch circuit."

"...proper attention must be given to coordination of cascaded surge protection devices."

Figure 8 demonstrates the effectiveness of a suppression system when used in a two-stage (cascaded) approach.

As demonstrated, the two-stage approach ensures that both types of disturbances are suppressed to negligible levels at the branch panel (<150V let-through). This prevents high-energy transients from damaging components and ensures that fast low-level ringwaves will not degrade or disrupt the operation of downstream microprocessors.

This ensures the system performance meets the following IEEE (Emerald Book, 1992) recommended performance:

"While electromechanical devices can generally tolerate voltages of several times their rating for short durations, **few solid-state devices can tolerate much more than twice their normal rating.** Furthermore, data processing equipment can be affected by fast changes in voltages with relatively small amplitude compared to the hardware-damaging overvoltages."

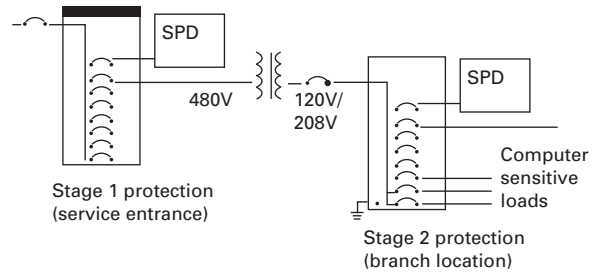

System test parameters:
IEEE C62.41 and C62.45 test procedures using C3 impulse
480V main entrance panels; 100 feet of entrance wire;
480/208V distribution transformer; and 120/208V branch

TABLE 3. EXAMPLE OF WYE SYSTEM—MODES OF PROTECTION PER PHASE (KA/Ø)

MODEL	L-N	L-G	NG	(L-N + L-G)
120 kA per phase TVSS	60	60	60	120

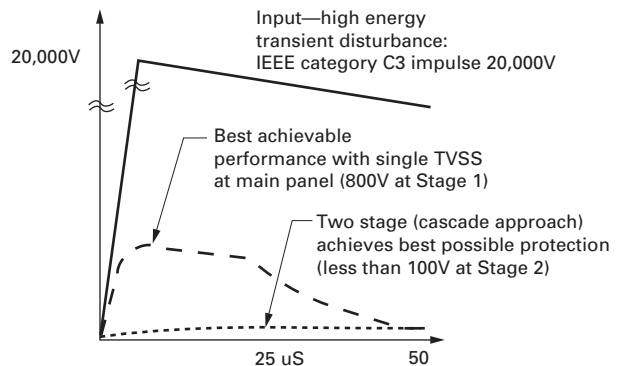

FIGURE 8. FACILITY-WIDE PROTECTION SOLUTIONS—IEEE EMERALD BOOK RECOMMENDS A CASCADE (OR 2-STAGE) APPROACH

Debunking the surge current myth, “Why excessive surge current ratings are not required”

When will it stop?

It seems that every year surge suppressor manufacturers are increasing the surge current ratings of their devices. For example, a well-known TVSS manufacturer has made the following recommendations to the consulting community for main panel surge protection:

TABLE 4. MANUFACTURER RECOMMENDATIONS

YEAR	RECOMMENDED SURGE CURRENT RATING (KA/PHASE)
1993	250 kA/phase
1994	350 kA/phase
1995	>500 kA/phase
2006	>1000 kA/phase

The same model has changed surge ratings three times in last several years! In fact in 1998, the company also introduced a unit that is theoretically rated to 650,000A per phase. The above example illustrates how some manufacturers use irrelevant justifications to promote the sale of a premium-priced suppressor.

We believe it is time to debunk the game and present the facts on what is an acceptable level of surge current for service entrance locations.

Why stroke current is not related to TVSS surge current

The stroke current associated with lightning is not related to a suppressor’s surge current rating. It is physically impossible to have the energy associated with a lightning stroke travel down the AC power conductors.

Figure 9 is a graph published by the IEEE Std. 1100 (the Emerald Book) and by the ANSI/IEEE C62.42 committee responsible for surge protection devices. The IEEE lightning research provides the following conclusions:

- Stroke current is related to the lightning strike (traveling between a cloud and earth or between clouds)

- 50% of recorded direct lightning strokes are less than 18,000A
- 0.02% of the strokes could have a surge current of 220 kA
- An unusual event was recorded that had a stroke of approximately 450 kA; however, this is a controversial measurement

TVSS myth

A TVSS manufacturer may suggest a “one in a million” lightning stroke will be conducted on the AC distribution system and enter a facility’s service entrance. To bullet-proof a facility against this “stroke current,” a surge suppressor with a surge current rating of 400 kA/phase is required.

Reality

Stroke current has no relationship to the “surge current” conducted on the AC power distribution system. There is no technical reason to specify a surge suppressor having 400 kA/phase surge current rating.

Discussion

In Florida (worst case in the U.S.), there are six ground flashes/year/km² (IEEE C62.41). A facility occupying one acre will experience one direct strike every 40 years. Based on the percentages in **Figure 9**, the facility will experience one stroke exceeding 200 kA every 800 years.

“The crest current magnitude of an actual lightning strike varies widely. Typical surges conducted or induced into wire line facilities would be considerably smaller because of the availability of alternate paths. As a result, protectors at the termination of these facilities are normally not designed to withstand the full crest current of direct strokes.”

When lightning hits the earth, a powerline or facility, most of the energy flashes to ground or is shunted through utility surge arrestors. The remaining energy that is induced on the AC power system is called surge current (measured in kA). The surge current shunted by a suppressor is a small fraction of the lightning stroke current.

Based on available research, IEEE recommends using the 20 kV, 10 kA combination wave as the representative test for induced lightning surges at service entrance locations. Above this amount, the voltage will exceed BIL ratings causing arcing in the conductors or distribution system.

In summary, low voltage wiring (<600V) is not capable of conducting the lightning stroke currents as presented in **Figure 9**. Engineers should not use lightning stroke current as a means of specifying suppressors having a rating over 400 kA/phase.

Why is 250 kA/phase an acceptable rating?

The above discussion proves that 500 kA lightning stroke current can not exist on the AC powerline. If IEEE recommends testing service entrance TVSS units to 10 kA, why do many suppliers, including us, suggest a 250 kA/phase device be installed? The answer is reliability, or, more appropriately, life expectancy.

A service entrance suppressor will experience thousands of surges of various magnitudes. Based on statistical data, we can determine the life expectancy of a suppressor. A properly constructed suppressor having a 250 kA/phase surge current rating will have a life expectancy greater than 25 years in high-exposure locations.

Note: A 400 kA/phase device would have more than 100 years—well beyond reasonable design parameters.

Should a suppressor fail, it is most likely due to temporary overvoltage (TOV) on the utility powerline; for instance, when a 120V circuit rises to 200 Vac or greater. A larger-sized suppressor will not protect against TOV.

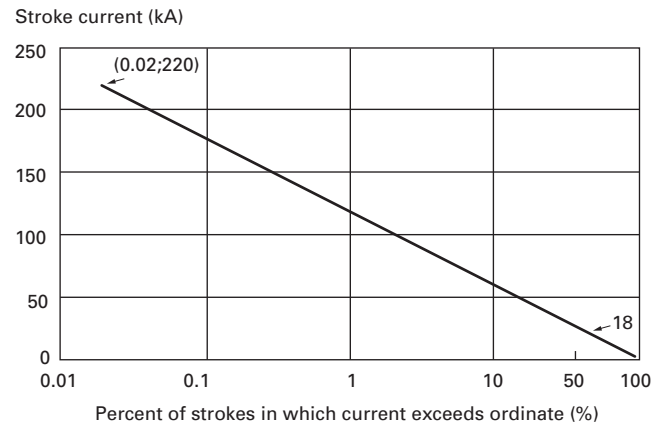

FIGURE 9. DISTRIBUTION OF LIGHTNING STROKE CURRENTS ①
① IEE STD. C62.42, 1992 PAR 3.1.1.

Surge arrestor vs. surge suppressor

The use of surge protection devices (surge suppressors) is growing at over 20% per year. Suppressors are now routinely installed at the service entrance and key down-stream panel-board or motor control center (MCC) locations to provide clean power to solid-state loads. Currently, there is some confusion between the application of surge arrestors and surge suppressors—especially in industrial facilities, water treatment plants and other areas where arrestors were predominately used. This section explains the differences in performance and application between the two technologies.

The evolution of surge/lightning arrestors

In the past, when nonlinear or solid-state devices such as computers, programmable logic controllers (PLCs) and drives were not yet in use, relays, coils, step switches, motors, resistors and other linear loads were the standard. Utility companies and end users were concerned with how to protect electrical distribution systems from lightning surges. Their objective was to ensure that voltage surges did not exceed the basic insulation level (BIL) of the conductor wires, transformers and other equipment. Consequently, arrestors were developed for use in low, medium and high voltage applications at various points in the transmission and distribution system. The fact that these devices created a “crowbar” between the phase conductor and ground did not matter to these loads if it cleared within a few cycles.

Arrestors are still used in the electrical industry primarily along the transmission lines and upstream of a facility’s service entrance. Arrestors are available in various classes depending upon their withstand capability (e.g., station vs. distribution class). At the service entrance location on low voltage systems (600V and below), surge suppressors are now replacing the use of arrestors.

The evolution of surge protection devices (also called TVSS)

In today’s computer age, the use of solid-state (nonlinear) loads is increasing dramatically. Research by utilities and other groups estimated that 70% of utility loads are consumed by electronic equipment such as drives, PLCs, computers, electronic ballasts, telecommunication equipment, and so forth.

Modern-day electronic equipment is getting faster, smaller, more efficient and very complex. These improvements have been made in all microprocessor-based equipment over the years, and this progress will continue.

The tradeoff in faster speed and lower cost is that the microprocessor loads are becoming increasingly more susceptible to the effects of transients and surges.

As a design objective, the IEEE Emerald Book (and the CBEMA curve) recommend reducing 20,000V-induced lightning surge disturbances down to two times nominal voltage (< 330V peak). To achieve this level of performance, surge suppressors were developed. Since the mid-1980s, these devices have become the preferred choice for protecting loads within any facility.

Lightning arrestors were designed to protect the electrical distribution system and not the sensitive solid-state equipment from the effects of lightning.

As in **Table 5**, lightning arrestors have a high let-through voltage, the key performance factor for protecting electronic loads. Under the IEEE Category C3 test wave (20 kV, 10 kA), the let-through voltage is typically over 1200V (on a 120 Vac system).

This is satisfactory for insulation protection on transformers, panelboards and wiring. For variable frequency drives (VFDs), computers, PLCs and other sensitive equipment, however, the solid-state components will be damaged or “upset” by these surges. Using suppressors at the service entrance and key branch panels, the surge will be effectively reduced to under 100V.

Note: If a TVSS and lightning arrestor are both used at a service entrance switchboard, the TVSS will do all of the work. It will “turn on” earlier and shunt most of the surge current.

Many water-treatment plants, telecommunication facilities, hospitals, schools and heavy industrial plants utilize TVSSs instead of surge arrestors to provide protection against the effects of lightning, utility switching, switching electric motors, and so on. New suppressor designs can now be integrated into motor control buckets, switchboards and other distribution equipment, providing more effective performance and eliminating installation problems.

When selecting a suppressor, look for a quality device having the following features:

- Low let-through under IEEE Category B3, C1 and C3 test waves
- Independently tested to the published surge current ratings (per phase)
- Includes internal fuses
- Includes internal monitoring features (for both open and shorted MOV failures)
- Includes electrical noise filtering (55 dB at 100 kHz)
- Small footprint design for more effective installation
- Listed under UL 1449, UL 1283, and CSA® approved

TABLE 5. DIFFERENCE BETWEEN ARRESTORS AND SUPPRESSORS

DESCRIPTION	SURGE ARRESTOR		SURGE SUPPRESSOR	
	480V (277V L-N)	208V (120V L-N)	480V (277V L-N)	208V (120V L-N)
Let-through voltages (based IEEE test waves):				
Cat. C3 (20 kV, 10 kA)	>1500V	>1000V	900V	470V
Cat. C1 (6 kV, 3 kA)	>1200V	>1000V	800V	400V
Cat. B3 (6 kV, 500A, 100 kHz)	>1500V	>1000V	200V	<150V
Internal monitoring capabilities (identify internal failure and activate remote alarm or lights)	No	No	Yes (most quality devices)	Yes (most quality devices)
EMI/ RFI filtering	No	No	Yes (most quality devices)	Yes (most quality devices)
Internal fusing (overcurrent protection)	No	No	Yes (most quality devices)	Yes (most quality devices)
Design	Gapped MOV	Gapped MOV	MOV/filter (hybrid)	MOV/filter (hybrid)
Interrupts power (crowbar)	Yes (typical 1/2 cycle)	Yes (typical 1/2 cycle)	No	No
Failure	Explosive	Explosive	Trips breaker/fuse	Trips breaker/fuse
Warranty	Limited	Limited	5 years or more (on most quality devices)	5 years or more (on most quality devices)
Life expectancy	Limited (throw-away devices)	Limited (throw-away devices)	>25 years (if sized appropriately)	>25 years (if sized appropriately)

Benefits of hybrid filtering in surge protection devices

A surge suppressor (TVSS device) prevents harmful surge voltages from damaging or disrupting sensitive electronic equipment. There are two types of suppression devices:

Basic suppressor devices—Transient suppressors that use only voltage-dependent components such as metal oxide varistors (MOVs) or silicon avalanche diodes (SADs).

Hybrid filter devices—Hybrid devices that employ a parallel capacitive filter circuit in addition to MOVs. Since these products are able to eliminate low-amplitude transients and high-frequency EMI/RFI noise, they are widely specified for commercial, hospital and industrial facility construction projects. (See **Figure 10**.)

Unfortunately, it is often difficult to distinguish between hybrid filter and basic suppressors when reviewing the performance specifications provided by the manufacturer of either type of device. In addition, specifying consultants are often unsure of the practical benefits offered by the filter components. This section describes the differences between the two technologies when installed in an electrical distribution system.

A hybrid filter protects sensitive electronic equipment against high-amplitude lightning impulses, low-level ringing

transients and EMI/RFI noise disturbances. In comparison, basic suppressors do not have filter components and can only suppress high voltage disturbances. **Table 6** summarizes the key differences between the two technologies.

a) Ringing transient suppression

Studies performed by ANSI/IEEE and other organizations indicate the oscillatory ringwave is the most common type of transient waveform occurring within a facility’s electrical distribution system. Normal impedance characteristics of a low voltage distribution system create ringing oscillatory waves at frequencies between 50 kHz and 250 kHz.

Internal transients at these frequencies are common and can result in damaged integrated circuits, system lock-ups, reboots or other operational problems. To model this ringing effect, ANSI/IEEE C62.41 (2002) recommends testing all suppression devices to the 100 kHz Ringwave (Category B3; 6000V, 500A waveform). (See **Figure 11**.)

Published let-through voltages are then used to compare suppression performance.

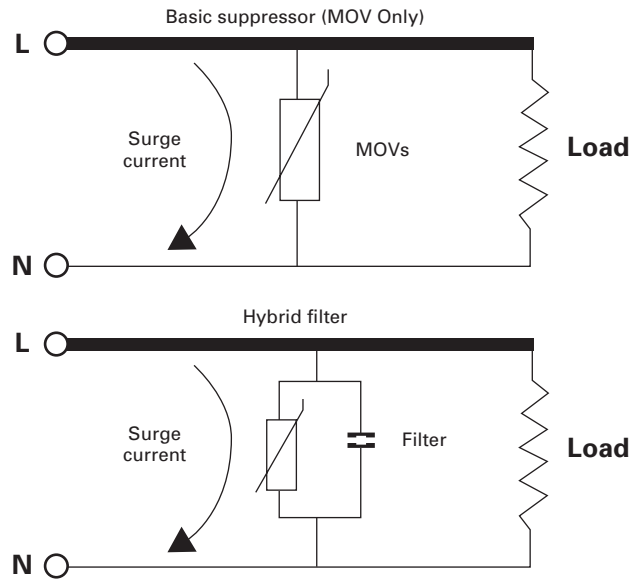

FIGURE 10. BASIC SUPPRESSOR AND HYBRID FILTER

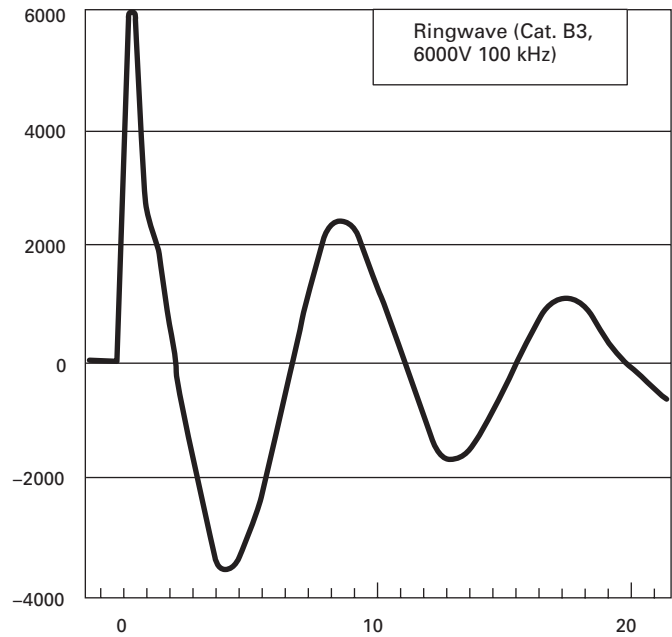

FIGURE 11. RINGWAVE

TABLE 6. COMPARISON OF SUPPRESSOR TECHNOLOGIES

TVSS performance criteria	Hybrid filter	Basic suppressor
Repetitive surge withstand capability	Longer life expectancy	Limited life
Ringing transient suppression	<300V let-through	>900V let-through
Electrical noise attenuation	50 dB @ 100 kHz	Poor attenuation
Facility-wide noise filtering	Coordinated from service entrance to branch panels	Not achievable

Figure 12 illustrates the superior performance of a hybrid filter suppressors when tested to the standard IEEE B3 Ringwave. Filter components provide a low-impedance path at higher frequencies (e.g., 100 kHz) allowing impulses to be shunted away from sensitive loads, at any phase angle along the 60 Hz AC sine wave. This “sine wave tracking” feature suppresses disturbances at much lower levels than possible with a basic suppressor (nonfiltered device).

Without a filter, the MOVs are able to clamp the transient only once when the voltage exceeds the “turn on” point of the MOV. As shown in **Figure 12**, the MOV let-through voltage is significantly higher due to the impedance associated with wire lead lengths and the MOV operating characteristics. This is over three times the let-through voltage of the TVSS filter. As a result, the level of protection provided is limited.

b) EMI/RFI noise attenuation

Filters remove high-frequency EMI/RFI noise associated with loads such as:

- Variable speed drives
- Photocopiers
- Large UPSs
- Arc welders
- SCR controlled loads
- Light dimmers

These types of noise generating loads are found in almost every facility. IEEE defines noise as disturbances less than two times peak voltage (e.g., less than 340V peak on 120V systems).

The key performance filter testing standard is the MIL-STD-220A, 50 Ohm insertion loss test. Manufacturers should publish noise attenuation levels measured in decibels (dB) obtained at 100 kHz. Test data based on computer simulations such as SPICE programs are not reflective of actual environmental conditions, and are therefore not acceptable for comparing filter performance. Also note that published dB ratings at frequencies over 1 MHz are meaningless for panel hybrid filter products. Above 1 MHz, EMI/RFI noise does not travel on the conductor (i.e., it is radiated and travels in the atmosphere).

For premium performance, the filter attenuation should exceed 50 dB at 100 kHz (based on MIL-STD-220).

Note: Have the suppressor supplier provide actual test results to ensure this level of filtering is being provided.

c) System noise/suppression capability

TVSS filters installed at the service entrance and branch panels meet with the IEEE-recommended approach to facility protection. Please see “Facility-wide surge suppression” on **page 9** for additional information.

In addition, a system-wide suppression design provides enhanced normal mode and common mode noise attenuation—significantly greater than a stand-alone device.

Summary

TVSS filters offer significant benefits that enhance the power quality within a facility. This section illustrates why TVSS filters are now the most commonly specified suppression technology.

Manufacturers may offer misleading claims and avoid publishing accurate performance standards. Engineers should ensure the suppression device chosen offers sufficient ringwave suppression, noise attenuation and provides coordinated facility protection. TVSS manufacturers claiming to offer sine wave tracking or filter components must support these claims by submitting test results and spectrum analysis. Without these submittals, it is likely a low-end suppressor will be supplied rather than the required hybrid filter.

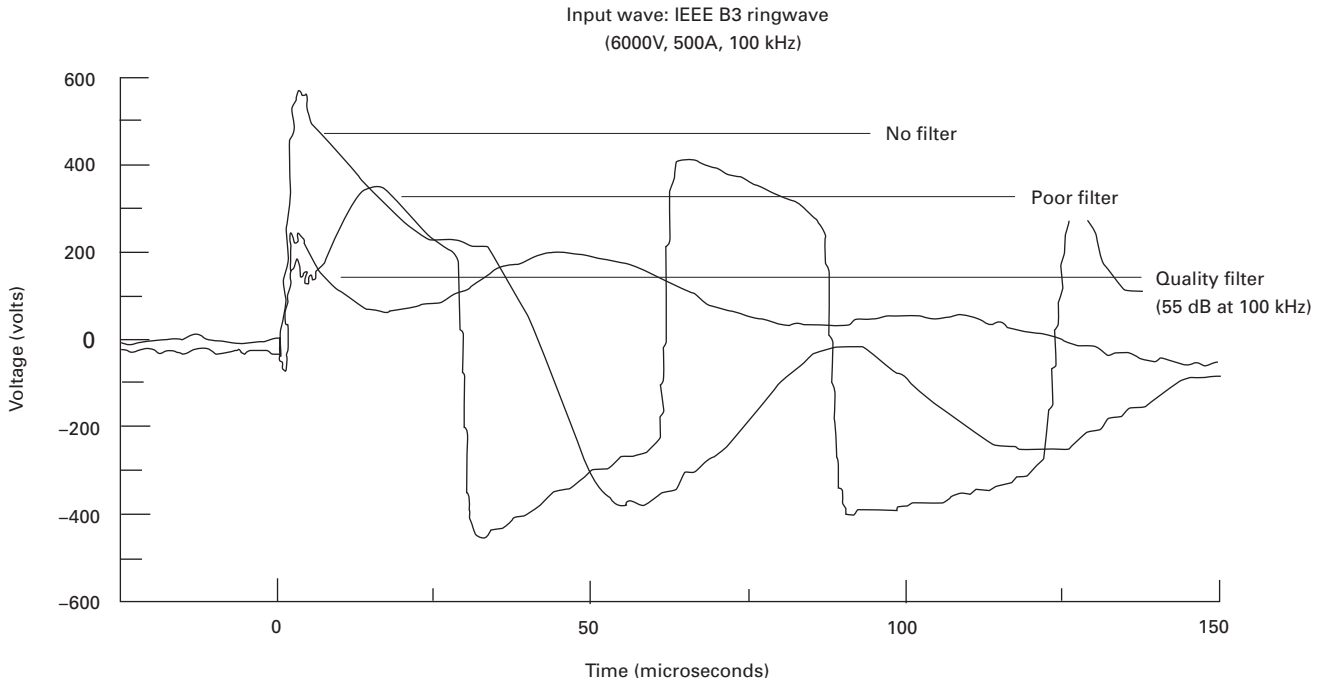

FIGURE 12. RINGWAVE SUPPRESSION CAPABILITIES

Factory automation (PLCs) and their need for surge suppression

End users often ask us why our surge protection is necessary for protecting process control systems. Most people assume that programmable controls and automation equipment are fully protected from power disturbances. As the following section explains, PLC manufacturers and service technicians recommend the use of surge suppressors and filters to prevent downtime and equipment damage due to surges and electrical line noise.

A major study on how power disturbances affect process control systems has been conducted by Dranetz Technologies and PowerCet corporation. Results of the study indicate that impulses, surges and electrical noise cause the following equipment problems:

- Scrambled memory
- Process interruption
- Circuit board failure
- AC detection circuits cause false shutdown
- Setting calibration drift
- Power supply failure
- Lock up
- SCR failures
- Program loss
- Digital/analog control malfunction

“Sensitivity to electrical interference varies dramatically from one system to another, depending upon grounding conditions, equipment sensitivity, system design and quantity of electronic equipment in the area.”^①

Facility downtime and repair costs associated with these power quality problems represent a growing concern for engineers and maintenance staff. Power protection is now widely recognized as an important factor in the design of process control systems. Major PLC manufacturers such as Allen-Bradley® and Siemens® provide the following recommendations:

^① Dranetz Field Handbook For Power Quality Analysis, 1991

1. Allen-Bradley SLC500 operational manual 1747-1002, Series A

“Most industrial environments are susceptible to power transients or spikes. To help ensure fault-free operation and protection of equipment, we recommend surge suppression devices on power to the equipment in addition to isolation equipment.”

“Lack of surge suppression on inductive loads may contribute to processor faults and sporadic operation. RAM can be corrupted (lost) and I/O modules may appear to be faulty or reset themselves.”

2. Siemens AG automation group EWA 4NEB 811 6130-02

“Measures to suppress interference are frequently only taken when the controller is already in operation and reception of a signal has already been affected. The overhead for such measures (e.g., special contactors) can often be considerably reduced by observing the following points when you install your controller. These points include:

- Physical arrangements of devices and cables
- Grounding of all inactive metal parts
- Filtering of power and signal cables
- Shielding of devices and cables
- Special measures for interference suppression

3. Allen-Bradley publication 1785-6.6.1

“Electromagnetic interference (EMI) can be generated whenever inductive loads such as relays, solenoids, motor starters or motors are operated by ‘hard contacts’ such as pushbuttons or selector switches. Following the proper wiring and grounding practices guards the processor system against the effects of EMI. However, in some cases you can use suppression networks to suppress EMI at its source.”

Regardless of the manufacturer, electronic equipment is susceptible to power disturbances. This results from two contributing factors:

1. Processors themselves are increasingly complex with higher chip density and lower operating voltages.
2. The growing use of disturbance generating loads such as adjustable frequency drives, capacitor banks, inductive loads and a wide variety of robotic equipment.

Eaton’s series type TVSS filters were developed exclusively for the protection of automation equipment used in industrial environments. With up to 85 dB of noise attenuation and outstanding transient suppression, these products are well suited for the protection of sophisticated microprocessor loads. A series power line filter is extremely cost-effective and less than one third the cost of a typical service call.

Consider improving your control system and your bottom line reliability.

Surge protection devices with replaceable modules

A surge protective device (SPD) design that is offered by several manufacturers is known as a modular design. Modular designs include parts that can be replaced in the field. The most common replaceable module version is a metal box with replaceable surge components housed in a smaller plug in plastic box.

In an SPD, the most commonly used surge suppression component is an MOV (metal oxide varistor). The MOV becomes a conductive component when the voltage across it exceeds a certain level known as the maximum continuous operating voltage (MCOV). Once the voltage exceeds MCOV, the current is allowed to flow through the MOV, which then passes the surge to ground. For SPDs that are modular, the MOVs are built into these plastic boxes that are available for field replacement if the internal MOV was damaged.

Some SPD manufacturers promote modular design to minimize their production costs. Plus, the use of modules create an aftermarket business for the SPD manufacturer. However, there are a number of potential technical flaws with modular designs.

- If one module is damaged, the remaining undamaged modules begin to compensate for the lost module, resulting in stress to the undamaged modules. This may lead to a second failure before the first module is replaced
- Many failures result in unacceptable damage to the interior of the metal box. Replacement of the modules is not sufficient to get the unit back to operating condition. These failures require replacement of the complete unit
- A damaged module may also cause unbalanced protection, in which the surge current is

not equally shared across the MOVs. Most manufacturers match the performance of the MOVs to achieve the specified performance. A new module will not be matched to the modules already in the product

- Many manufacturers of modular designs utilize “banana” pin connectors instead of low-impedance bolt-on connection or leads. During high surge currents, the mechanical forces can rip these connectors out of their sockets. Many environmental conditions can degrade these connectors, as they rely solely on spring force to keep the connection
- Performance specifications can be misleading. Often the published suppression ratings are for the individual module and not for the entire SPD unit. Some manufacturers have designed modular products just for this reason. It is important to get the SVR (UL’s surge voltage ratings, markings required on all UL-listed products) ratings and surge current ratings for both the module and for the complete product

Another aspect to look at closely is theoretical surge current ratings. In order for accurate theoretical surge current ratings, there are two design criteria that must be considered.

1. Integrity of internal wiring

Low-end surge suppression devices may use small diameter circuit traces or wires, which cannot handle the rated surge current. Exposure to a large transient the modules can survive, but the total product cannot survive, leaving downstream loads unprotected.

Most of the time these potential wiring deficiencies are inside of the SPD and hidden from the customer or specifying engineer.

2. Equal current sharing to each MOV

The SPDs internal wiring must ensure that each component is electrically balanced. In other words, a suppressor manufacturer must ensure the following performance criteria are met:

- Integrity of rated surge performance
- All surge paths must achieve the rated surge current
- Life expectancy

The total device must meet its lifetime performance rating.

A possible result to SPDs that do not share surge current equally is premature failure. Premature failure is a common problem in modular designs since “newer” and “older” modules do not have the same MOV voltage, and therefore experience a reduction in surge current capacity.

The Clipper Power System, Visor™ series (CPS) and Eaton TVSS units are designed to utilize the benefits of ground plane technology in the construction of suppressors. The electrical foundation of all our Visor SPDs employ a multilayer, low-impedance SurgePlane™ circuitry.

Because power surges and electrical line noise are high-frequency disturbances, the current travels on the surface of the plane due to skin effect. The surge plane design provides the largest possible conducting area without the drawbacks of heavy gauge wire. At these frequencies, the impedance (self and mutual inductance) of the solid copper plane is significantly lower than even large diameter wire or bus bars.

Since all MOVs attached to the plane are at the same potential and all the MOVs are electrically matched, surge current is equally shared. Stress on the MOVs is reduced because each MOV carries a smaller and equal proportion of the total surge, resulting in significantly longer life expectancy compared to devices that do not provide equal current sharing.

Features of the SurgePlane include:

- Lowest possible self-inductance due to the high surface area
- Mutual inductance is reduced due to the geometry of the circuitry
- Reduced let-through voltage
- Improved reliability

Since there are significant quality differences among surge protection devices (SPDs), we encourage engineers to check the SPD’s electrical foundation. The consulting engineer should verify that surge current is equally shared among components and other possible problems are dealt with before accepting them as equal.

Why silicon avalanche diodes are not recommended for AC powerline suppressors

A surge protection device, also called a TVSS device, is used to protect semiconductor loads from powerline transients. SPDs are installed in the AC power system at the service entrance and panelboards, and sometimes at the load. SPDs are also required on data communication lines to prevent ground loops and induced surges, which can damage equipment.

In AC power applications, over 95% of SPDs use metal oxide varistors because of their high-energy capability and reliable clamping performance. For added performance, hybrid designs (MOVs and capacitive filter) are typically specified.

A small number of SPD manufacturers still promote the use of silicon avalanche diodes for AC applications. These companies attempt to scare customers into buying a premium-priced unit by publishing misleading information about MOV surge components. The following section summarizes the marketing claims and technical insights regarding SADs suppressors.

Three SAD myths and reality

Myth number one: SADs have a faster response time (e.g., 5 picosecond compared to 1 nanosecond for MOVs). The faster SAD response time results in improved SPD performance.

1. NEMA LS-1 and IEEE committees do not mention the use of response time as an SPD specification. All SPDs have sufficient response time to “turn on” and shunt surges. The response time of an MOV is 1000 times faster than the time it takes for a surge to reach full current (i.e., 8 microseconds). Response time is not an appropriate criteria to use when specifying SPDs.

2. The response time for a SAD device is equivalent to that of an MOV device. Response time of

the device is affected more by the internal wiring/connection than the speed of the SAD (or MOV). For example, a SAD may react in one picosecond, but the internal wiring and connecting leads within the SPD add inductance (about 1 to 10 nanohenrys per inch). This inductive effect is the dominating factor in overall response time—not the SAD reaction time.

3. Note that hybrid filters (MOVs combined with capacitive filtering) react the fastest because the capacitors activate instantaneously to any high frequency surge.

Myth number two: MOVs degrade resulting in short life expectancy of the SPD and unsafe failures. SADs do not degrade and are safer to use.

Life expectancy of SADs is much lower than that of an MOV (see **Figure 13**). A single SAD will be damaged by a surge under 1000A. Given that IEEE C62.41 requires SPDs to withstand 10,000A surges, SADs do not have sufficient energy capabilities for service entrance or branch panel applications. To hide this weakness, SAD devices often publish Joule ratings or wattage instead of publishing surge current capacity per phase (a more reflective performance criteria).

Note: IEEE and NEMA do not recommend the use of Joule ratings for SPD comparison.

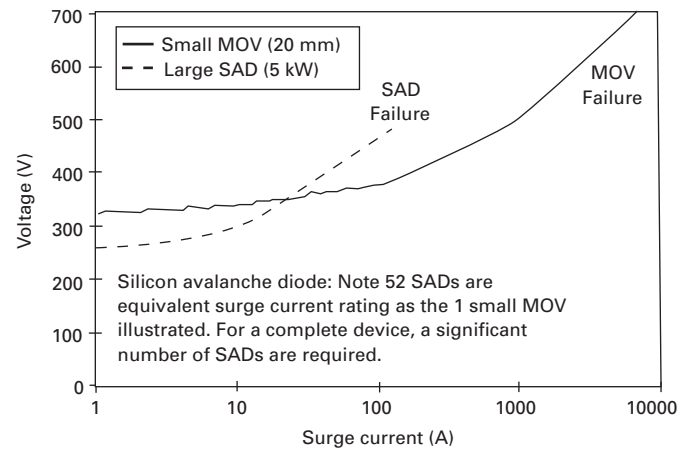

FIGURE 13. SILICON AVALANCHE DIODES HAVE LIMITED ENERGY CAPABILITY

MOVs are rated from 6500A to 40,000A, making them more reliable for AC power systems.

Quality SPDs often parallel MOVs to achieve surge current ratings in excess of 250,000A per phase. These results can be verified through independent testing at lightning labs. At these ratings, the SPD will operate effectively for over 25 years in IEEE-classified high exposure environments.

Paralleling SADs is more difficult than with MOVs. Suppressors using parallel SADs require a significant amount of components, which reduce the overall device reliability.

Given the limited energy ratings of SADs, these devices are not recommended for panelboard or switchboard applications. Similarly, hybrid designs using MOVs and SADs do not achieve component synergies. In high-energy applications, for example, the SADs are the weak link because the SADs and MOVs cannot be coordinated to work together.

Failure mode. SAD manufacturers claim that their units do not degrade. Rather than degrade, the SAD fails in a short circuit mode at much lower energy levels than a MOV. A properly constructed MOV suppressor will not degrade, even when exposed to thousands of high-energy strikes. Ask your supplier to provide independent testing to guarantee the device achieves the published surge current ratings (and thus, the required life expectancy). Degradation problems do exist with the very inexpensive surge bars. These devices are usually manufactured offshore and are poorly constructed utilizing underrated MOVs. These low-quality devices should not be compared to the SPDs typically used at panelboards or service entrance locations.

Myth number three: SADs provide tighter clamping than MOVs.

When exposed to IEEE-defined test waveforms and UL 1449 test results, both MOV and SAD devices have the same suppression voltage ratings. Accordingly, UL does not regard SAD devices as providing any better clamping than MOV based SPDs.

Summary

There are a number of myths in the SPD industry. When evaluating SPDs, it is important to evaluate the performance of the suppressor unit and not compare individual internal elements. In other words, SPD construction methods and internal wiring/fusing limitations are critical to overall performance. Independent testing is essential when comparing the performance of these units.

Based on the proven track record of performance, MOV-based suppressors are highly reliable. That is why almost all suppressors still employ MOV components. For service entrance or panelboard locations, SADs are not recommended because of their limited energy capability. SADs are primarily used to protect dataline and communication wires.

TABLE 7. COMPARISON OF COMPONENTS USED IN SURGE PROTECTION DEVICES

SPD component	Advantages and Disadvantages
Metal oxide varistor (MOV)	Highest energy capability, excellent reliability and consistent performance, better mechanical connectivity for paralleling multiple components. Nonlinear clamping curve gradually degrades over repeated use (only at high surge levels), moderate capacitance.
Silicon avalanche diode (SAD)	Flatter clamping curve, excellent reliability and consistent performance. Very low energy capability, expensive.
Selenium cells	Moderate to high-energy capability. Very high leakage current, high clamping voltage, bulky, expensive, obsolete components.
Gas tubes	High-energy capability, very low capacitive (requirement for data line applications). Unpredictable and unstable repetitive behavior, “crowbar” to ground (unsuitable for AC systems), expensive.
Hybrid SPD	MOV/filter is most common hybrid; incorporates the advantages of other components while overcoming the problems associated with each individual component (achieves long life expectancy, faster response, better clamping performance). Inherent problems with hybrid SPDs using MOV and SAD, or devices using selenium cells (inability to have the various components “work together”).

Surge protective device frequently asked questions

1. What are surges (also called transients, impulses, spikes)?

An electrical surge (transient voltage) is a random, high-energy, short duration electrical disturbance. As shown in **Figure 14**, it has a very fast rise time (1–10 microseconds). Surges, by definition, are sub-cycle events and should not be confused with longer duration events such as swells or temporary overvoltages.

High-energy surges can disrupt, damage or destroy sensitive microprocessor-based equipment. Microprocessor failure results from a breakdown in the insulation or dielectric capability of the electronics.

Approximately 80% of recorded surges are due to internal switching transients caused by turning on/off motors, transformers, photocopiers or other loads. The IEEE C62.41 surge standard has created the Category B3 ringwave and the B3/C1 combination wave to represent higher energy internal surges.



Externally generated surges due to induced lightning, grid switching or from adjacent buildings account for the remaining recorded surges. The Category C3 combination wave (20 kV, 10 kA) represents high-energy surges due to lightning. Refer to the CPS Technote #1 for more information on IEEE surge standards.

2. Why is there a need for surge protective devices?

In the coming years, electronic devices will represent half of the electrical demand in the United States. Electronics, consist of microprocessors that rely on digital signals: fast on/off coded sequences. Distortion on the power or signal lines may disrupt the sensitive signal sequence. As electronic components become smaller and more powerful, they become more sensitive. The tremendous proliferation in the use of sensitive electronic equipment—sensitive by virtue of circuit density (microchips having literally thousands of transistors on a single chip)—is now incorporated into almost every new electrical device. Surge protection is now the standard technology for increasing the reliability and uptime of microprocessors.

Microprocessors can be “upset,” “degraded” or “damaged” by surge events. Depending on the magnitude of the surge, the system configuration and the sensitivity of the load. **Table 8** summarizes the results of a major survey conducted by Dranetz on the effects of surges on different microprocessor equipment.

TABLE 8. SUMMARY OF MAJOR SURVEY RESULTS ON THE EFFECTS OF SURGES ON DIFFERENT MICROPROCESSOR EQUIPMENT ①

	Impulse 4X	Impulse 2X	Repetitive disturbance (noise)
Impact to electronic loads			
Circuit board failure	Yes	Yes	—
Data transmission errors	Yes	Yes	Yes
Memory scramble	Yes	Yes	Yes
Hard disk crash	Yes	—	—
SCR failure	Yes	—	—
Process interrupt	Yes	Yes	Yes
Power supply failure	Yes	—	—
Program lock-up	Yes	Yes	Yes

① Source: Dranetz Handbook for Power Quality

Other references for the recommendation of surge protective devices includes:

- IEEE Emerald Book (Std. 1100)
- FIPS 94
- IEEE C62.41
- Manufacturers (Allan-Bradley®, Motorola®, other suppliers)
- NEMA LS-1
- NFPA 780

As a design objective, the IEEE Emerald Book (and the CBEMA curve) recommends reducing 20,000V induced lightning surge disturbances down to two times nominal voltage (<330V peak). To achieve this level of performance, surge suppressors were developed. Since the mid-1980s, surge protective devices mounted at switchboards, panelboards and MCCs have become the preferred choice for protecting all loads within a facility.

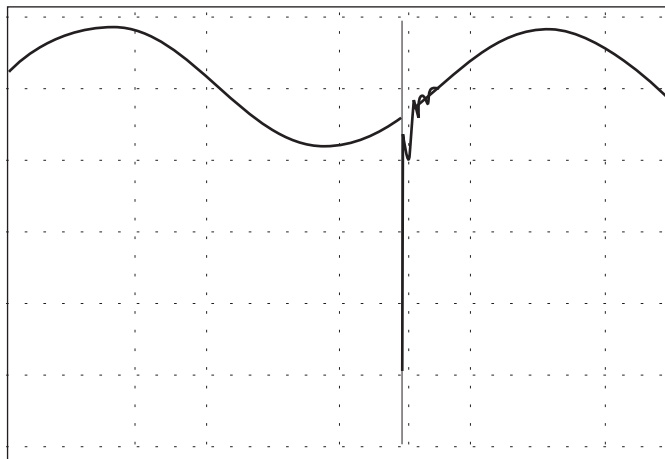

FIGURE 14. AN EXTERNALLY CREATED ELECTRICAL SURGE CAUSED BY INDUCED LIGHTNING

3. Where do I need an SPD? Why do I need to implement a two-stage approach?

As recommended by IEEE (Emerald Book 2005), SPDs should be coordinated in a staged or cascaded approach. The starting point is at the service entrance. (Service entrance protection is also required by NFPA 780.) The first surge diversion occurs at the service entrance, then any residual voltage can be dealt with by a second SPD at the power panel of the computer room, or other critical load (see **Figure 15**). This two-stage approach will reduce 20,000V induced lightning surges well under 330V peak as recommended by IEEE and CBEMA.

4. Is there a difference between a TVSS and an SPD?

No, Underwriters Laboratories (UL) uses the term transient voltage surge suppressor, while NEMA, IEC and IEEE use surge protective device (SPD). An SPD/TVSS is a device that attenuates (reduces in magnitude) transient voltages.

5. How does an SPD work?

The design goal is to divert as much of the transient disturbance away from the load as possible. This is accomplished by shunting the energy to ground through a low-impedance path (i.e., the surge suppressor).

Metal oxide varistors are the most reliable and proven technology to reduce transient voltages. Under normal conditions, the MOV is a high-impedance component. When subjected to a voltage surge (i.e., voltage is over 125% of

the nominal system voltage), the MOV will quickly become a low-impedance path to divert surges away from loads. The MOV reaction time is nanoseconds—1000 times faster than the incoming surge.

In AC power applications, over 95% of SPDs use metal oxide varistors because of their high-energy capability and reliable clamping performance. For added performance and SPD life expectancy, a filter element is used in conjunction with the MOVs.

Silicon avalanche diodes (SADs) are frequently used in dataline or communication surge protectors. They are not recommended for use in high-exposure AC applications due to their limited energy capabilities.

Selenium cells were once used in surge applications, but are now an outdated technology. They were used in the 1920s, but were replaced in the 1960s by the more efficient SADs and MOVs. One TVSS company continues to use selenium-enhanced surge protection as a marketing ploy to create confusion with engineers. Selenium cells are metallic rectifiers (diodes) having a maximum reverse voltage of 25 Vdc. Many selenium plates are stacked together to create sufficient voltage breakdown for use in AC power circuits. When mounted in parallel with MOV components, selenium offers no performance, cost or application advantages. In fact, they are expensive and add considerable space (which makes installation more difficult). There are no patents on selenium cells.

6. What criteria are important when specifying a suppressor?

A specification should focus on the essential performance, installation and safety requirements. A number of surge specifications contain misleading criteria that do not follow NEMA LS-1 or other recommended performance standards.

The following are considered essential performance/safety/installation criteria for a specification:

- A. Surge current per phase—250 kA/phase for service entrance, 120 kA/phase for panelboards or other locations.
- B. Let-through voltage—specify the performance voltage rating based on the three standard IEEE test waveforms (IEEE C62.41 Category C3 and B3 combination waves; and BE ringwave). Specify the required ratings for applicable nominal voltages (i.e., 208 vs. 480). This data should be requested as part of the project submittal process.

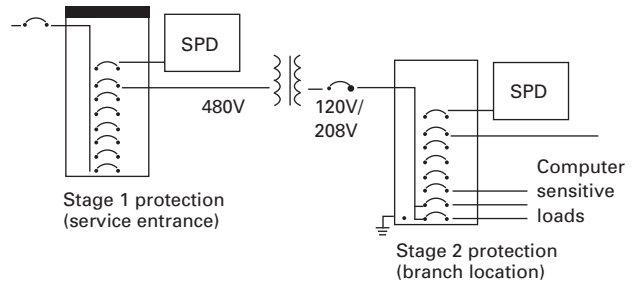

System test parameters:
 IEEE C62.41 and C62.45 test procedures using C3 Impulse
 480V main entrance panels; 100 feet of entrance wire;
 480/208V distribution transformer; and 120/208V branch

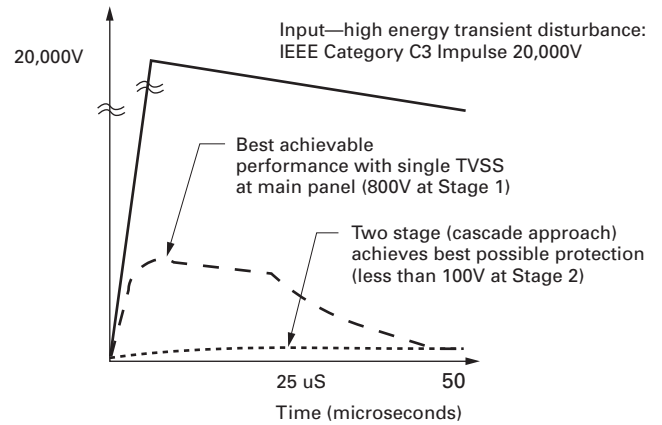

FIGURE 15. FACILITY-WIDE PROTECTION SOLUTIONS IEEE EMERALD BOOK RECOMMENDS A CASCADED (OR 2-STAGE) APPROACH

C. Effective filter—noise attenuation at 100 kHz based on the MIL-STD-220 insertion loss test. The attenuation should exceed 45 dB (L-N modes). Specify that insertion loss bode plots are provided as submittals.

D. Integrated installation—factory installed as part of the distribution equipment. Check to ensure the installation minimizes lead length.

E. Internal fusing—safety and overcurrent protection. 200 kAIC internal fusing system.

F. Reliability monitor and Diagnostic system—foolproof status indication for each phase. A popular option is to include Form C contacts for remote monitoring.

G. Independent testing—to ensure a reliable construction and design, specify that all manufacturers submit results from an independent test lab verifying the device can achieve the published surge current ratings (on a per mode and per phase basis).

For more information on specification recommendations or a copy of sample specification, contact Eaton.

7. What is surge current capacity?

Defined by NEMA LS-1 as: The maximum 8/20 U.S. surge current pulse the SPD device is capable of surviving on a single impulse basis without suffering either performance or degradation of more than 10 percent deviation of clamping voltage.

Listed by mode, since number and type of components in any SPD may vary by mode.

The industry standard is to publish surge current “per phase” by summing modes L-N + L-G in a wye system and L-L + L-G in delta systems.

Surge current capacity is used to indicate the protection capability of a particular SPD design, and should be used on a per phase and per mode basis when specifying an SPD for a given application.

Beware: Manufacturers are not required to have their units independently tested to their published surge current capacity rating. Most published ratings are theoretical, and calculated by summing the individual MOV capabilities. Manufacturer “A” may claim a rating of 100 kA, but due to the poor construction integrity, the unit is unable to share current equally to each MOV. Without equal current sharing, the published surge current rating cannot be met. Specifiers should request that manufacturers submit independent test reports from lightning labs confirming the published surge ratings.

All clipper units have been independently tested to meet or exceed their published surge current capacities.

8. What surge current capacity is required?

Surge current capacity is dependent on the application and the amount of required protection. What is the geographic location of the facility and the exposure to transients? How critical is the equipment to the organization (impact of downtime, repair costs)?

Based on available research, the maximum amplitude of a lightning-related surge on the facility service entrance is 20 kV, 10 kA combination wave (refer to IEEE C62.41). Above this amount, the voltage will exceed BIL ratings causing arcing in the conductors or distribution system.

Eaton recommends 250 kA per phase for service entrance applications (large facilities in high-exposure locations), and not more than 120 kA per phase at branch panel locations.

If IEEE and other research specifies the maximum surge to be 10 kA, why do many suppliers, including Eaton, suggest up to a 250 kA per phase device be installed? The answer is reliability, or, more appropriately, life expectancy. By increasing the kA rating of the suppressor, you are not increasing performance, but instead the life expectancy of the suppressor.

A service entrance suppressor will experience thousands of surges of various magnitudes. Based on statistical data, we can determine the life expectancy of a suppressor. A properly constructed suppressor having a 250 kA per phase surge current rating will have a life expectancy greater than 25 years in high exposure locations.

Beware: Some manufacturers recommend installing SPDs having surge current ratings over 250 kA per phase. In fact, some are promoting ratings up to 600 or 700 kA per phase. This level of capacity is ridiculous and offers no benefits to customers. A 400 kA per phase device would have approximately 500-year life expectancy for medium exposure location—well beyond reasonable design parameters. (Eaton is forced to build higher rated units to meet competitor specifications, however, we strongly recommend that consultants question suppliers who promote excessive ratings for commercial reasons.)

Today’s SPDs will not fail due to lightning surges. Based on two decades of experience, the failure rate of an SPD is extremely low (<0.1%). Should a suppressor fail, it is likely the result of excessive temporary overvoltage (TOV) due to a fault on the utility power line; for example, the nominal 120 Vac line exceeds 180V (for many cycles). TOV will damage surge protectors and other electronic loads. Should this rare event occur, call your utility to investigate the problem. (For more information on TOV problems in international environments, refer to the IEEE article written by Eaton for the 1997 INTELEC conference, Australia).

9. What is let-through voltage (clamping voltage)?

Let-through voltage is the amount of voltage that is not suppressed by the SPD and passes through to the load. **Figure 16** is an example of let-through voltage.

Let-through voltage is a performance measurement of a surge suppressor's ability to attenuate a defined surge. IEEE C62.41 has specified test waveforms for service entrance and branch locations. A surge manufacturer should be able to provide let-through voltage tests under the key waveforms (i.e., Category C3 and C1 combination waveforms; Category B3 Ringwave).

Beware: The UL 1449 (2nd Edition, 1988) conducts a 500A let-through voltage test. This test does not provide any performance data and is not a key specification criterion.

Clamping voltage is often confused with let-through voltage. Clamping voltage refers to the operating characteristic of a metal oxide varistor component and is not useful for comparing the performance of an SPD. The clamping voltage is the voltage when 1 mA of current passes through an MOV. Clamping voltage does not include the effects of internal wiring, fusing, mounting lugs, or installation lead length.

Let-through voltage is a more applicable test for SPDs, and refers to the amount of voltage that is not suppressed by an SPD when tested to an IEEE defined surge waveform and test setup.

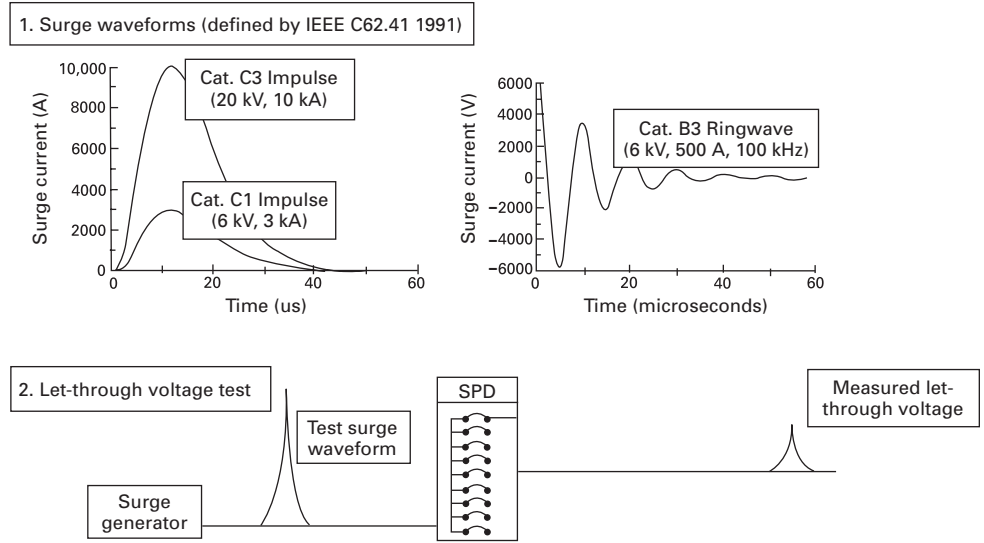

FIGURE 16. EXAMPLE OF LET-THROUGH VOLTAGES AND DIFFERENT IEEE DEFINED SURGE WAVEFORMS

10. Why is installation important? What effect does it have on an SPD's performance?

Installation lead length (wiring) reduces the performance of any surge suppressor. As a rule of thumb, assume that each inch of installation lead length will add between 15 and 25V per inch of wiring. Because surges occur at high frequencies (approximately 100 kHz), the lead length from the bus bar to the suppression elements creates impedance in the surge path.

As one specifier said, "No matter which TVSS device you buy, it is the installation requirements/inspection that are the most important factor of the surge specification."

Published let-through voltage ratings are for the device/module only. These ratings do not include installation lead length (which is dependent on the electrician installing the unit). The actual let-through voltage for the system is measured at the bus bar and is based on two factors:

1. The device rating (quality of the suppressor).
2. The quality of the installation.

For example, consider an SPD having a 400V rating (based on IEEE Cat. C1 test waveform).

Connected to a panelboard with just 14 inches of #14 wire, approximately 300V are added to the let-through voltage.

The true let-through at the bus bar is thus 700V.

Installation lead length can increase let-through voltage by 15 to 25V per inch

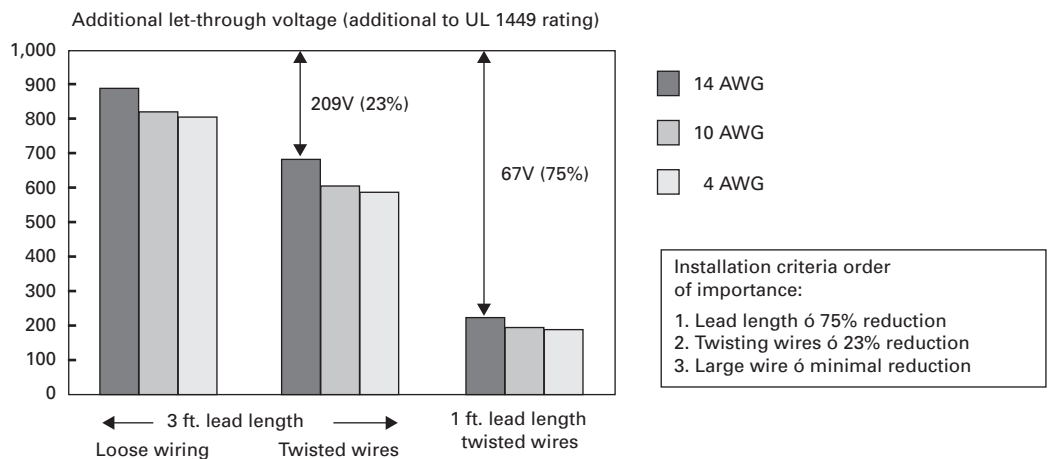

FIGURE 17. ADDITIONAL LET-THROUGH VOLTAGE USING IEEE C1 (6000V, 3000A) WAVEFORM (UL1449 TEST WAVE)

11. Why should suppressors be integrated into the electrical distribution equipment (panelboards, switchboards)?

Most consulting specifiers are now requiring the gear manufacturer integrate the suppressor inside the switchboard, panelboard or MCC. Integrated suppression offers a number of key benefits compared to externally mounted applications:

1. Performance—Integrating the SPD into the electrical distribution equipment eliminates the installation lead length, ensuring significantly improved performance (much lower let-through values).

2. Control—There is no chance that field installation is done incorrectly. By having the suppressor factory installed and tested, the specifier does not have to check the installation and force the contractor to reinstall the device (a costly and time-consuming process). This reduces future claims and problems for the engineer and end customer.

3. Reduce wall space.

Integrating the suppressor eliminates the wall space taken up by the externally mounted suppressor (between two and three feet!).

4. One source for warranty claims. Should a problem occur, the customer eliminates potential warranty conflicts between manufacturers.

5. Reduced installation costs. There is no contractor fees for mounting SPDs.

The Cutler-Hammer Clipper Power System is integrated into all of our low voltage distribution equipment.

Through our innovative direct bus bar connection, we limit the lead length between the SPD and electrical equipment. For example, the Clipper Power System carries a UL 1449 let-through voltage rating of 400V.

Through our “zero lead length” direct bus bar connection, we obtain a let-through voltage of 420V at the panelboard bus bar. A significant performance advantage over traditional cable connected designs.

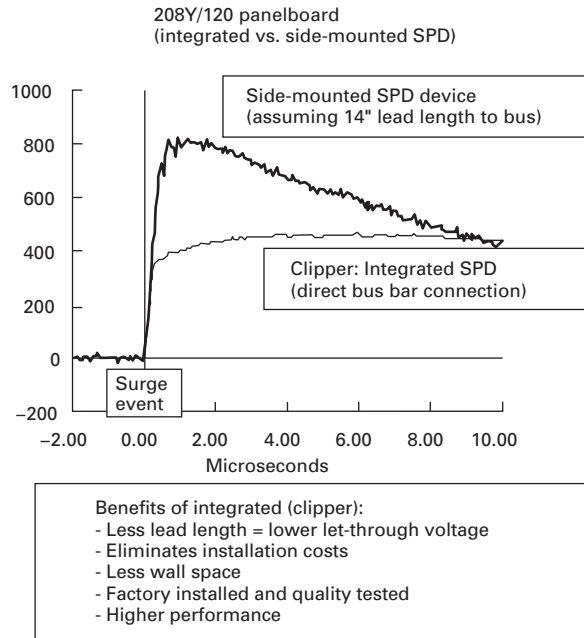
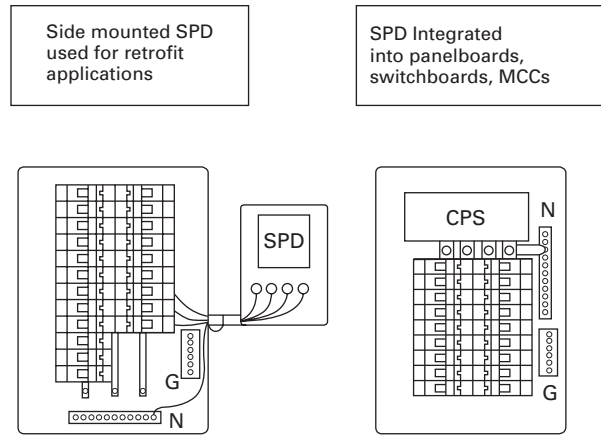

FIGURE 18. INTEGRATED SPD PERFORMANCE

Some SPD manufacturers have obtained a UL procedure for installing their SPD into another manufacturer’s panelboard. When this occurs, the original panelboard manufacturer’s UL label (UL67) is void, as is the warranty provided by that manufacturer. The SPD manufacturer then modifies and integrates the SPD into its panelboard, and must assume all warranty and liability issues regarding the panelboard and SPD.

In most cases, the original panelboard manufacturer’s nameplate data is not removed and replaced by that of the SPD manufacturer. This can cause problems for the end customer as different panelboards within this facility carry the nameplates from the original panelboard manufacturer, but two separate companies cover the warranty.

12. What is the benefit of filtering (sine wave tracking)?

Filtering eliminates electrical line noise and ringing transients by adding capacitors to the suppression device. (See **Figures 19** and **20**.)

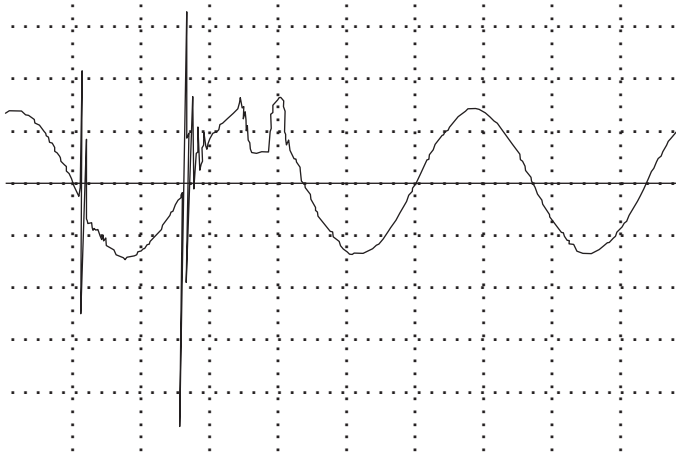

FIGURE 19. INTERNALLY GENERATED RINGWAVE

Note: Ringwaves typically resonate within a facility at frequencies between 50 kHz and 250 kHz.

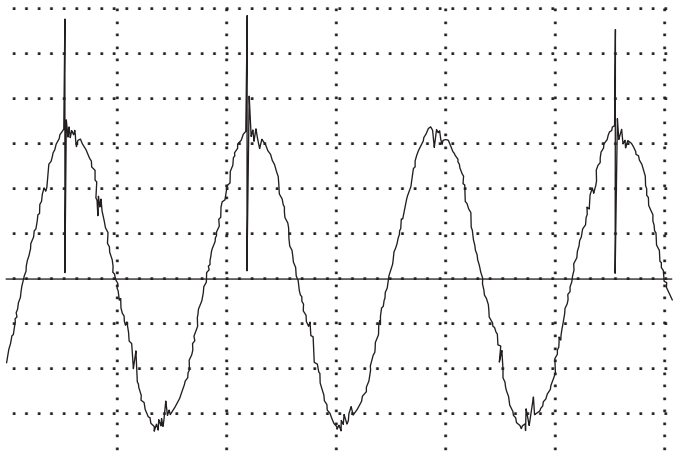

FIGURE 20. EMI/RFI ELECTRICAL LINE NOISE

Note: Noise is any unwanted electrical signal that produces undesirable effects. Noise is typically less than two times peak voltage.

Hybrid SPD—A device that combines the benefits of both MOVs and filtering. A properly designed hybrid SPD will vastly outperform any SPD using only MOVs.

Beware: Filtering is often referred to as “sine wave tracking” or active tracking.” These are marketing terms and have no relevance to filter performance. Not all SPDs provide filtering, and many SPDs claim to possess “sine wave tracking,” “sine wave contour,” or EMI/RFI noise attenuation, but may not employ a quality filter.

Key filtering specifications:

- MIL-STD-220A attenuation at 100 kHz measured in dB. A higher dB rating (i.e., >40 dB) reflects better performance
- Let-through voltage: IEEE C62.41 Category B3 Ringwave. On a 120V system L-N should be <200V
- UL 1283 listing for noise filtration

13. Why Joules and response time are irrelevant specifications?

Joule ratings are not an approved specification for surge protective devices. IEEE, IEC and NEMA do not recommend using Joule ratings when specifying or comparing surge suppressors, because they can provide misleading and conflicting information. For example, on a 120V system, a 150V or 175V MOV could be used. Even though the 175V MOV has a higher Joule rating, the 150V has a much lower let-through voltage and offers better surge protection.

Joule ratings are a function of let-through voltage, surge current and surge duration (time). Each manufacturer may use a different standard surge wave when publishing Joules. Given the confusion regarding Joule ratings, the power quality industry does not recommend the use of Joule ratings in performance specifications.

Response time—All suppressors have sufficient response time to react to surges. In fact, the MOV will react 1000 times faster than the surge. NEMA and IEEE do not recommend using “response time” as a performance criteria when comparing SPDs.

14. Is an SPD with replaceable “modules” superior to non-replaceable designs?

No. Some manufacturers promote a modular design to minimize production costs, and create an “aftermarket business” in modules. There are a number of technical flaws with many modular designs.

1. If one module is damaged, all modules should be replaced (undamaged modules are stressed and provide unbalanced protection). Eaton, as well as several other manufacturers, recommends a complete replacement, or replacement of all modules to ensure safety and reliability.

2. Easy to cheat on performance specifications (often suppression ratings are for an individual module; unit ratings are not published).

3. Modular designs utilize “banana” pin connectors to connect modules rather than a low impedance bolt-on connection.

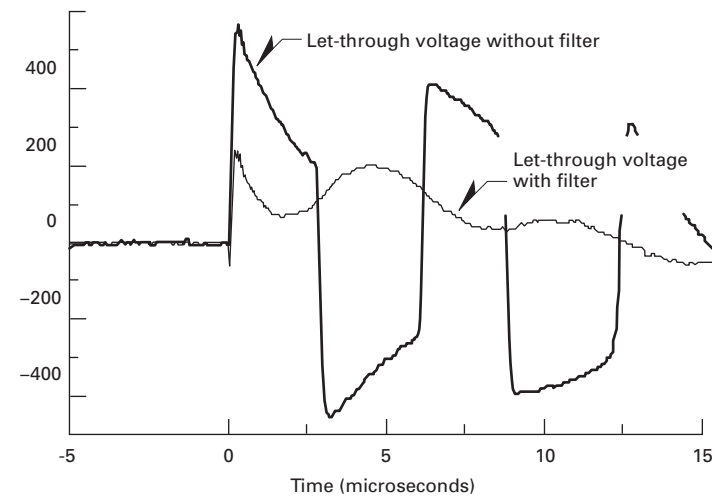

FIGURE 21. FILTER PERFORMANCE BASED ON CAT. B3, 100 KHZ, 6000V

15. Is maintenance required for an SPD?

Maintenance is not a requirement for a quality SPD. A quality SPD should last over 25 years without any preventive maintenance program. Note the recommendations by Dr. Ronald B. Standler (a leading authority on SPDs) in his book *Protection of Electronic Circuits from Overvoltages*, page 229:

"The protection circuit should require minimal or no routine maintenance. Consumable components, such as fuses, should have an indicator lamp to signal the need for replacement. Requiring routine maintenance increases the cost of the protection circuits, although the money comes from a different budget."

The SPD should come with a diagnostic system that will provide continuous monitoring of the fusing system and protection circuits (including neutral to ground) and be capable of identifying any open circuit failures. The monitoring system should also include a detection circuit to monitor for overheating (in all modes) due to thermal runaway.

16. What is the difference between a surge protector and an arrester?

Prior to the microprocessor revolution, most electrical devices were linear loads, relays, coils, step switches, motors, resistors, and so forth. Utility companies and end users were primarily concerned with preventing voltage surges from exceeding the basic insulation level (BIL) of the conductor wires, transformer windings, and other equipment. Consequently, lightning arrestors were developed for use in low, medium, and high voltage applications. The fact that these devices create a "crowbar" between the phase conductor and ground does not matter to linear loads, as this is cleared within a few cycles.

Lightning arrestors are still used in the electrical industry primarily along the transmission lines and upstream of a facility's service entrance. Low voltage systems (600V and below), now have surge protectors at the service entrance and branch panels in place of lightning arrestors. Surge protectors offer the following advantages over arrestors:

- Low let-through voltage (better performance)
- Longer life expectancy
- Improved safety (less destructive debris if damaged)
- Full monitoring capability
- Internal fusing
- Filtering capabilities to remove low level surge/noise

17. Does an SPD give me 100% coverage for electrical loads?

No! An SPD protects against surges—one of the most common types of electrical disturbances. Some SPDs also contain filtering to remove high frequency noise (50 kHz to 250 kHz). They do not provide filtering against harmonic loads (3rd through 50th harmonic equals 180 to 3000 Hz).

An SPD can not prevent damage caused by a direct lightning strike.

A direct lightning strike is a very rare occurrence; in most cases lightning causes induced surges on the power line that are reduced by the SPD.

There is no device that can prevent damage from direct lightning strikes.

An SPD can not stop or limit problems due to temporary overvoltage. Temporary overvoltage is a rare disturbance caused by a severe fault in the utility power or due to problems with the ground (poor or nonexistent N-G bond). Temporary overvoltage occurs when the Vac exceeds the nominal voltage (120V) for a short duration (millisecond to a few minutes). If the voltage exceeds 25% of the nominal system voltage, the SPD and other loads may become damaged.

An SPD device does not provide backup power during a power outage. An uninterruptible power system (UPS) is required to provide battery backup power.

Abbreviations

ANSI	American National Standards Institute
CSA	Canadian Standards Association
EMP	Electromagnetic pulse
EMI	Electromagnetic interference
IEC	International Electrotechnical Commission
IEEE	Institute of Electrical and Electronics Engineers
NEMA	National Electrical Manufacturers Association
RFI	Radio frequency interference
UL	Underwriter Laboratories
LEMP	Lightning EMP
NEMP	Nuclear EMP

References

	Institute of Electrical and Electronics Engineers (IEEE) Standard 100-1988 standard Dictionary of electrical and electronic terms
IEEE C62	Collection of guides and standards for surge protection
IEEE C62.41	Guide for surge voltages in low voltage AC power circuits
IEEE C62.45	Guide on surge testing for equipment connected to low voltage AC power circuits
IEEE (Std. 1100)	Emerald Book
UL 96	Standard for safety installation requirements for lightning protection systems
UL 452	Standard for safety-antenna discharge units
UL 497A	Standard for safety secondary protectors for communication circuits
UL 498	Standard for safety-receptacle and receptacle plugs (including direct plug-in devices)
UL 544	Standard for safety-medical and dental equipment
UL 1283	Standard for safety electromagnetic interference filters
UL 1363	Standard for safety temporary power taps (power strips)
UL 1449	Standard for safety transient voltage surge suppressors
NEMA LS-1	Low voltage surge protective device

Eaton Corporation is a diversified power management company ranked among the largest Fortune 500 companies. The electrical group is Eaton's largest division and is a global leader in electrical control, power distribution, power quality, automation, and monitoring products and services. Eaton's global electrical brands, including Cutler-Hammer®, MGE Office Protection Systems™, Powerware®, Holec®, MEM®, Santak and Moeller, provide customer-driven PowerChain Management® solutions to serve the power system needs of the industrial, institutional, government, utility, commercial, residential, IT, mission critical and OEM markets worldwide.

PowerChain Management solutions help enterprises achieve sustainable and competitive advantages through proactive management of the power system as a strategic, integrated asset throughout its life cycle. With Eaton's distribution, generation and power quality equipment; full-scale engineering services; and information management systems, the power system is positioned to deliver powerful results: greater reliability, operating cost efficiencies, effective use of capital, enhanced safety, and risk mitigation.

Eaton Corporation
Electrical Group
1000 Cherrington Parkway
Moon Township, PA 15108
United States
877-ETN-CARE (877-386-2273)
Eaton.com

© 2009 Eaton Corporation
All Rights Reserved
Printed in USA
Publication No. SA01005003E / Z8383
March 2009

Note: Features and specifications listed in this document are subject to change without notice and represent the maximum capabilities of the software and products with all options installed. Although every attempt has been made to ensure the accuracy of information contained within, Eaton makes no representation about the completeness, correctness or accuracy and assumes no responsibility for any errors or omissions. Features and functionality may vary depending on selected options.



**PowerChain
Management®**

PowerChain Management is a registered trademark of Eaton Corporation.

All other trademarks are property of their respective owners.



Powering Business Worldwide