

Eaton® 93PM Integrated Accessory Cabinet – Power Distribution

208V 4–Wire IAC-PD

480V 3–Wire IAC-PD

480V 4–Wire IAC-PD

Installation and Operation Manual



Powering Business Worldwide

p/n: P-164000694
Revision 02

IMPORTANT SAFETY INSTRUCTIONS SAVE THESE INSTRUCTIONS

This manual contains important instructions that you should follow during installation and maintenance of the UPS and batteries. Please read all instructions before operating the equipment and save this manual for future reference.

CONSIGNES DE SÉCURITÉ IMPORTANTES – CONSERVER CES INSTRUCTIONS

Ce manuel comporte des instructions importantes que vous êtes invité à suivre lors de toute procédure d'installation et de maintenance des batteries et de l'onduleur. Veuillez consulter entièrement ces instructions avant de faire fonctionner l'équipement et conserver ce manuel afin de pouvoir vous y reporter ultérieurement.



IMPORTANT

To ensure you have the most up-to-date content and information for this product, please review the latest manual revision on our website, www.eaton.com/93PM.

Eaton reserves the right to change specifications without prior notice. Eaton is a registered trademark of Eaton. National Electrical Code and NEC are registered trademarks of National Fire Protection Association, Inc. ERIFLEX and FLEXIBAR are registered trademark of Erico International Corporation. All other trademarks are property of their respective companies.

©Copyright 2019 Eaton, Raleigh, NC, USA. All rights reserved. No part of this document may be reproduced in any way without the express written approval of Eaton.

Table of Contents

1 Introduction	1
1.1 Introduction	1
1.2 Features and Model Configurations	2
1.3 Installation Features	3
1.4 Using This Manual	6
1.5 Conventions Used in This Manual	6
1.6 Symbols, Controls, and Indicators	7
1.7 For More Information	7
1.8 Getting Help	8
1.9 Equipment Registration	8
2 Safety	9
2.1 Safety Warnings	9
3 Installation Plan and Unpacking	11
3.1 Installation Plan and Unpacking	11
3.1.1 Creating an Installation Plan	11
3.2 Preparing the Site	11
3.2.1 Environmental and Installation Considerations	11
3.2.2 IAC-PD Power Wiring Preparation	18
3.3 Inspecting and Unpacking the IAC-PD	25
4 Installation	27
4.1 Installation	27
4.1.1 Preliminary Installation Information	27
4.2 Unloading the IAC-PD Cabinet from the Pallet	27
4.3 Installing IAC-PD External Power Wiring	31
4.3.1 Input Wiring	31
4.3.2 Output Wiring	33
4.4 Adjustable Subfeed Breakers	38
4.5 Initial Startup	39
4.5.1 Completing the Installation Checklist	39
4.5.2 Installation Checklist	39
5 Onelines and Schematics	41
5.1 IAC-PD Onelines and Schematics	41
5.1.1 Onelines	41
5.1.2 Schematics	45
6 Operation	51
6.1 Integrated Accessory Cabinet-Power Distribution Operating Instructions	51
6.1.1 IAC-PD Breakers	51

Table of Contents

6.1.2 IAC-PD Operation	51
7 Maintenance.....	55
7.1 Maintenance	55
7.1.1 Important Safety Instructions	55
7.2 Performing Preventive Maintenance	55
7.2.1 DAILY Maintenance	55
7.2.2 PERIODIC Maintenance	55
7.2.3 ANNUAL Maintenance.....	55
7.3 Maintenance Training	56
8 Product Specifications	57
8.1 Product Specifications	57
8.1.1 Models	57
8.1.2 Specifications	57
8.1.2.1 Input	57
8.1.2.2 Output.....	58
8.1.2.3 Environmental and Safety Specifications.....	58
9 Warranty	59
9.1 Warranty.....	59

List of Figures

Figure 1.	Eaton 93PM IAC-PD	1
Figure 2.	Eaton 93PM UPS with Left-Mounted Eaton 93PM IAC-PD	4
Figure 3.	Eaton 93PM UPS with Right-Mounted Eaton 93PM IAC-PD	4
Figure 4.	Eaton 93PM UPS with Sidecar with Left-Mounted Eaton 93PM IAC-PD	5
Figure 5.	Eaton 93PM UPS with Sidecar with Right-Mounted Eaton 93PM IAC-PD	5
Figure 6.	93PM IAC-PD Cabinet Dimensions (Front, Right Side, and Back Views)	13
Figure 7.	93PM IAC-PD Dimensions (Top and Bottom Views).....	14
Figure 8.	93PM IAC-PD Center of Gravity.....	15
Figure 9.	Cabinet Ventilation – Rear Venting	16
Figure 10.	Cabinet Ventilation – Top Venting	17
Figure 11.	Eaton 93PM IAC-PD as Shipped on Metal and Wood Pallet	26
Figure 12.	Removing the Pallet Skids and Supports – Eaton 93PM IAC-PD.....	28
Figure 13.	Line-Up-and-Match Wiring Access Locations.....	30
Figure 14.	Top and Bottom Conduit Landing Wire Entry Locations	30
Figure 15.	Input Power Terminal Locations – 480V/208V.....	32
Figure 16.	IAC-PD with Two Panelboards – Terminal Locations	34
Figure 17.	IAC-PD with Top Subfeed Breaker and Bottom Panelboard – Terminal Locations	35
Figure 18.	Subfeed Breaker Output Power Terminal Detail.....	36
Figure 19.	IAC-PD with Top and Bottom Subfeed Breakers – Terminal Locations	37
Figure 20.	93PM IAC-PD with Single Panelboard.....	41
Figure 21.	93PM IAC-PD with Dual Panelboards	42
Figure 22.	93PM IAC-PD with One, Two, or Three 250A Subfeed Breakers and a Single Panelboard	42
Figure 23.	93PM IAC-PD with One or Two 400A Subfeed Breakers and a Single Panelboard	43
Figure 24.	93PM IAC-PD with Four 400A Subfeed Breakers	44
Figure 25.	93PM IAC-PD with Two 400A Subfeed Breakers	44
Figure 26.	93PM IAC-PD Configuration A and F Schematic.....	46
Figure 27.	93PM IAC-PD Configuration B, G, and I Schematic.....	47
Figure 28.	93PM IAC-PD Configuration C and H Schematic	48
Figure 29.	93PM IAC-PD Configuration D and J Schematic.....	49
Figure 30.	93PM IAC-PD Configuration E and K Schematic.....	50
Figure 31.	93PM IAC-PD Breakers – Two Panelboards	52
Figure 32.	93PM IAC-PD Breakers – Top Subfeed Breakers with Bottom Panelboard.....	53
Figure 33.	93PM IAC-PD Breakers – Subfeed Breakers.....	54

List of Figures

List of Tables

Table 1.	IAC-PD Cabinet Weights	12
Table 2.	IAC-PD Cabinet Clearances.....	12
Table 3.	IAC-PD Weight and Center of Gravity Dimensions	15
Table 4.	IAC-PD Input Device Specification	19
Table 5.	IAC-PD Input Power Wiring Recommendations.....	20
Table 6.	IAC-PD Output Power Wiring Recommendations (Panelboards and Subfeeds)	23
Table 7.	IAC-PD Fuse and Breaker Details	24
Table 8.	Recommended 208 Vac Input Circuit Breaker Rating.....	24
Table 9.	JG-Frame 250A Subfeed Breaker Continuous Current (I _r) Settings	38
Table 10.	K-Frame 400A Subfeed Breaker Continuous Current (I _r) Settings	38

List of Tables

Chapter 1 Introduction

1.1 Introduction

The Eaton® 93PM Integrated Accessory Cabinet-Power Distribution (IAC-PD) is designed for use with the Eaton 93PM Series Uninterruptible Power Supplies (UPSs). The IAC-PD provides power distribution options for servers, racks, and other equipment via distribution panelboards, or distributes power to larger loads via distribution subfeed circuit breakers. The distribution options are customer configurable, enabling adaptation and expansion without costly electrical rework.

Three configurations are available:

- 93PM 208V 4-Wire IAC-PD
- 93PM 480V 3-Wire IAC-PD
- 93PM 480V 4-Wire IAC-PD

The IAC-PD is housed in a single free-standing cabinet with safety shields behind the front door for hazardous voltage protection. The cabinets match the UPS cabinet in style and color.

[Figure 1](#) shows the Eaton 93PM IAC-PD.

NOTE Startup and operational checks must be performed by an authorized Eaton Customer Service Engineer, or the warranty terms specified in paragraph [9.1 Warranty](#) become void. This service is offered as part of the sales contract for the UPS. Contact an Eaton service representative in advance (usually a two-week notice is required) to reserve a preferred startup date.

Figure 1. Eaton 93PM IAC-PD

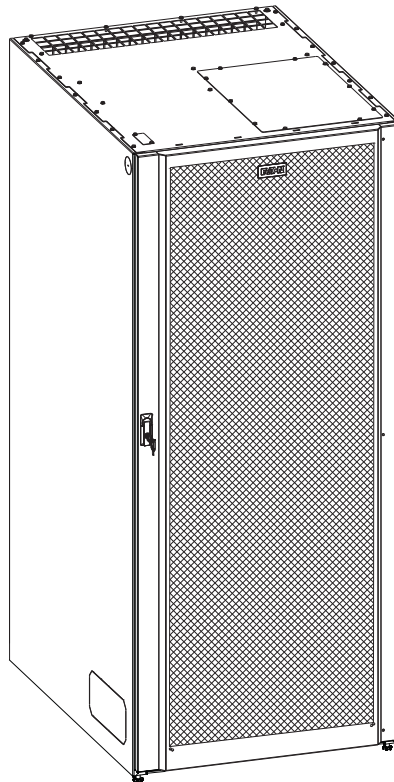

1.2 Features and Model Configurations

The IAC-PD is highly configurable, offering customers various distribution options for the bottom and/or the top position within the cabinet.

Key features and options include:

- Various bottom and/or top distribution combinations factory installed.
- Distribution options include panelboards and subfeed breakers (250A or 400A subfeed options available).
- Bottom position must always have a distribution option selected, while the top position may remain empty.
- The IAC-PD voltage configuration is selectable and will be configured and labeled by the factory as one of three options:
 1. 120/208V 4-Wire
 2. 277/408V 4-Wire
 3. 480V 3-Wire
- If a subfeed distribution option is ordered with less than the maximum number of subfeed breakers, the unit will include factory pre-wired subfeed provisions to allow for additional, field installable subfeed breakers.

IAC-PD 120/208V 4-Wire Model Configurations:

The following 120/208V 93PM IAC-PD model configurations are available for use with the 93PM UPS Series:

- One or two PRL1a 225A or 400A 42-pole distribution panels boards. If equipped with one 225A and one 400A panel board, the 400A panel board must be in the bottom position.
- One PRL1a 225A or 400A 42-pole distribution panel in the bottom position and up to three JG-Frame 3-pole 250A subfeed distribution breakers in the top position.
- One PRL1a 225A or 400A 42-pole distribution panel in the bottom position and up to two K-Frame 3-pole 400A subfeed distribution breakers in the top position.
- Up to two K-Frame 400A subfeed distribution breaker in the bottom position and up to two K-Frame 400A subfeed distribution breakers in the top position.

NOTE 1 JG-Frame 250A subfeed breakers are not available for the bottom position.

NOTE 2 Two K-Frame 400A subfeed breakers must be selected for the bottom position before a top distribution option can be selected.



NOTE 3 PRL1a panelboards used at 120/208V 4W are provided with provisions for BAB or QBHW type branch breakers.

NOTE 4 BAB/QBHW bus mountings are not interchangeable with GHB bus mountings.

IAC-PD 277/480V 4-Wire and 480V 3-Wire Model Configurations:

The following 277/480V 4-Wire or 480V 3-Wire 93PM IAC-PD model configurations are available for use with the 93PM UPS Series:

- One or two PRL2a 225A 42-pole distribution panels boards.
- One PRL2a 225A 42-pole distribution panel in the bottom position and up to three JG-Frame 3-pole 250A subfeed distribution breakers in the top position.
- One PRL2a 225A 42-pole distribution panel in the bottom position and up to two K-Frame 3-pole 400A subfeed distribution breakers in the top position.
- Up to two K-Frame 400A subfeed distribution breaker in the bottom position and up to two 400A subfeed distribution breakers in the top position.

NOTE 1 JG-Frame 250A subfeed breakers are not available for the bottom position.

NOTE 2 Two K-Frame 400A subfeed breakers must be selected for the bottom position before a top distribution option can be selected.



NOTE 3 PRL2a panelboards used at 277/480V 4W or 480V 3W are provided with provisions for GHB type branch breakers.

NOTE 4 BAB/QBHW bus mountings are not interchangeable with GHB bus mountings.

1.3 Installation Features

- The IAC-PD is designed to be installed in line-up-and-match or standalone configurations:
 - In line-up-and-match configurations input power wiring is routed through the side panels between the 93PM UPS and the IAC-PD. This option is only available with the 208V/220V 93PM UPS. In line-up-and-match configurations, the IAC-PD Input power cabling is factory provided.
 - In standalone configurations input power wiring is routed using external conduit through top or bottom entry conduit plates. This option is available with the 208V/220V 93PM UPS, 480V 93PM UPS, and the Eaton 93PM Integrated Accessory Cabinet - Distribution (93PM IAC-D). In standalone configurations, the IAC-PD Input power cabling is customer provided.
 - Output wiring is routed using external conduit through top or bottom entry conduit plates.
- To reduce installation time, connections to the input power connections are made via easily accessible mechanical compression lug terminals bolted to the input bus bars. The panelboard load connections are made directly to the breaker, with the neutral and ground wiring attaching to the voltbars. Subfeed load connections are made to the subfeed's terminal block all of which are located at the front of the cabinet.
- Top or rear ventilation options are available.
- The cabinet can be leveled and secured in place using the leveling feet.

A line-up-and-match IAC-PD is installed adjacent to the 93PM UPS. The IAC-PD may be installed on the left or right side of the UPS cabinet. See [Figure 2](#) through [Figure 5](#) for line-up-and-match configuration views.

Figure 2. Eaton 93PM UPS with Left-Mounted Eaton 93PM IAC-PD

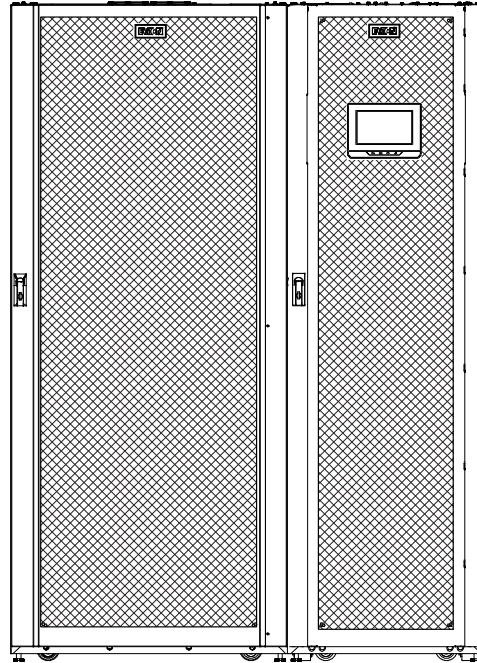

Figure 3. Eaton 93PM UPS with Right-Mounted Eaton 93PM IAC-PD

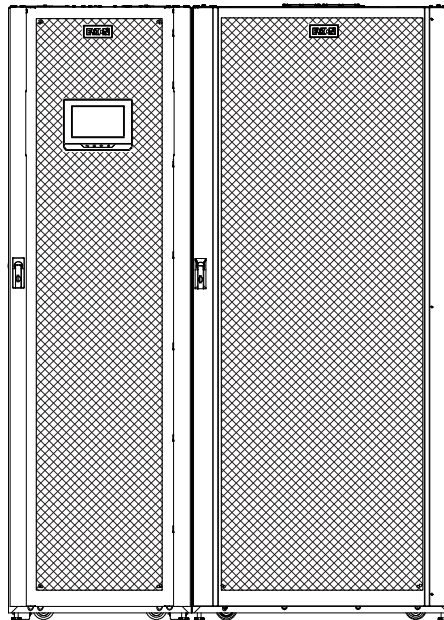

Figure 4. Eaton 93PM UPS with Sidecar with Left-Mounted Eaton 93PM IAC-PD

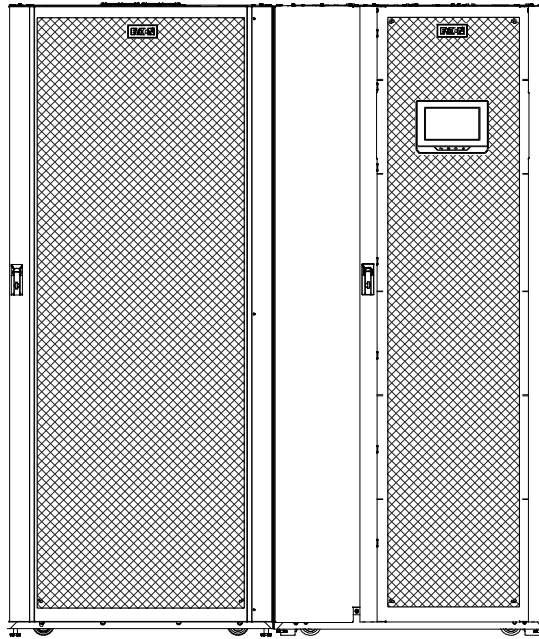
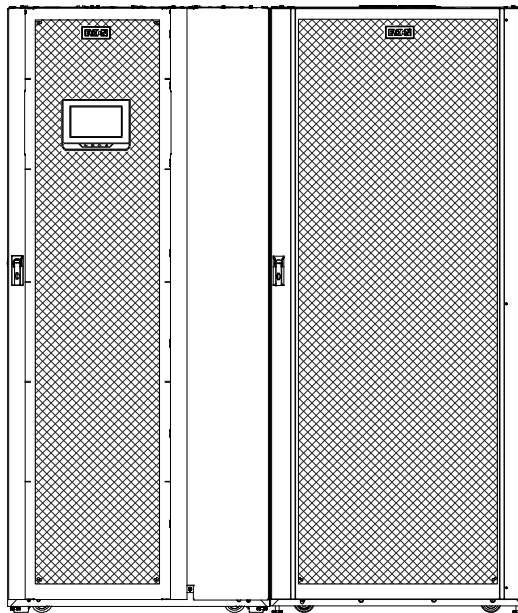

Figure 5. Eaton 93PM UPS with Sidecar with Right-Mounted Eaton 93PM IAC-PD



1.4 Using This Manual

This manual describes how to install the IAC-PD. Read and understand the procedures described to ensure trouble-free installation and operation.

Read through each procedure before beginning the work. Perform only those procedures that apply to the UPS system being installed or operated.

1.5 Conventions Used in This Manual

This manual uses these type conventions:

- **Bold type** highlights important concepts in discussions, key terms in procedures, and menu options, or represents a command or option that you type or enter at a prompt.
- *Italic type* highlights new terms where they are defined.
- `Screen type` represents information that appears on the screen or LCD.

Icon	Description
NOTE	Information notes provide pertinent information about important features or instructions.
[Keys]	Brackets are used when referring to a specific key, such as [Enter] or [Ctrl].

In this manual, the term *UPS* refers only to the UPS cabinet and its internal elements. The term *UPS system* refers to the entire power protection system – the UPS cabinet, an external battery system, and options or accessories installed.

The term *line-up-and-match* refers to accessory cabinets that are physically located adjacent to the UPS. The term *standalone* refers to accessory cabinets that are located separate from the UPS.

1.6 Symbols, Controls, and Indicators

The following are examples of symbols used on the UPS or accessories to alert you to important information:



RISK OF ELECTRIC SHOCK - Observe the warning associated with the risk of electric shock symbol.



CAUTION: REFER TO OPERATOR'S MANUAL - Refer to your operator's manual for additional information, such as important operating and maintenance instructions.



This symbol indicates that you should not discard the UPS or the UPS batteries in the trash. This product contains sealed, lead-acid batteries and must be disposed of properly. For more information, contact your local recycling/reuse or hazardous waste center.



This symbol indicates that you should not discard waste electrical or electronic equipment (WEEE) in the trash. For proper disposal, contact your local recycling/reuse or hazardous waste center.

1.7 For More Information

Refer to the *Eaton 93PM-L UPS 20–60 kW (208V) Installation and Operation Manual*,
the *Eaton 93PM-L UPS 20–120 kW (208V) Installation and Operation Manual*,
the *Eaton 93PM-L UPS 20–160 kW (208V) Installation and Operation Manual*,
the *Eaton 93PM-L UPS 20–200 kW (208V) Installation and Operation Manual*,
the *Eaton 93PM UPS (20–50 kW, 480V – 50 kW Frame) Installation and Operation Manual*,
the *Eaton 93PM UPS 400V/480V Four-Wire – 50 kW Frame) Installation and Operation Manual*,
the *Eaton 93PM UPS (20–100 kW, 480V – 100 kW Frame) Installation and Operation Manual*,
the *Eaton 93PM UPS 400V/480V Four-Wire – 100 kW Frame) Installation and Operation Manual*,
the *Eaton 93PM UPS (20–150 kW, 480V – 150 kW Frame) Installation and Operation Manual*,
the *Eaton 93PM UPS 400V/480V Four-Wire – 150 kW Frame) Installation and Operation Manual*,
the *Eaton 93PM UPS 400V/480V Four-Wire – 200 kW Frame) Installation and Operation Manual*,
or the *Eaton 93PM UPS (100–400 kW, 480V – 400 kW Frame) Installation and Operation Manual* for the following additional information:

- UPS, optional components, and accessory installation instructions, including site preparation, planning for installation, wiring and safety information, and detailed illustrations of cabinets and optional accessories with dimensional and connection point drawings
- UPS operation, including UPS controls, functions of the UPS, standard features and optional accessories, procedures for starting and stopping the UPS, information about maintenance, communication capabilities and responding to system events
- Communication capabilities of the UPS system

Visit www.eaton.com/powerquality or contact an Eaton service representative for information on how to obtain copies of these manuals.

1.8 Getting Help

If help is needed with any of the following:

- Scheduling initial startup
- Regional locations and telephone numbers
- A question about any of the information in this manual
- A question this manual does not answer

Please call the Customer Reliability Center at:

United States:

1-800-843-9433

Canada:

1-800-461-9166 ext 260

All other countries:

Call your local service representative

Please use the following e-mail address for manual comments, suggestions, or to report an error in this manual:

E-ESSDocumentation@eaton.com

1.9 Equipment Registration

Please visit www.eaton.com/pg/register to register your new Eaton UPS / Eaton UPS Accessory.

Model Number:

Serial Number:

Chapter 2 Safety

2.1 Safety Warnings

IMPORTANT SAFETY INSTRUCTIONS SAVE THESE INSTRUCTIONS

This manual contains important instructions that should be followed during installation and maintenance of the UPS system and batteries. Read all instructions before operating the equipment and save this manual for future reference.

The UPS system is designed for industrial or computer room applications, and contains safety shields behind the door and front panels. However, the UPS system is a sophisticated power system and should be handled with appropriate care.

DANGER

This UPS system contains LETHAL VOLTAGES. All repairs and service should be performed by AUTHORIZED SERVICE PERSONNEL ONLY. There are NO USER SERVICEABLE PARTS inside the UPS. Failure to follow these instructions may result in serious injury or death.

WARNING

- The UPS system is powered by its own energy source (batteries). The output terminals may carry live voltage even when the UPS is disconnected from an AC source.
 - To reduce the risk of fire or electric shock, install this UPS system in a temperature and humidity controlled, indoor environment, free of conductive contaminants. Ambient temperature must not exceed 40°C (104°F). Do not operate near water or excessive humidity (95% maximum). The system is not intended for outdoor use.
 - As a result of the connected loads, high leakage current is possible. Connection to earth ground is required for safety and proper product operation. Do not check UPS system operation by any action that includes removal of the earth (ground) connection with loads attached.
 - Ensure all power is disconnected before performing installation or service.
 - ELECTRIC ENERGY HAZARD. Do not attempt to alter any UPS system or battery wiring or connectors. Attempting to alter wiring may result in serious injury or death.
-

 **CAUTION**

- Installation or servicing should be performed by qualified service personnel knowledgeable of UPS and battery systems, and required precautions. Keep unauthorized personnel away from equipment. Consider all warnings, cautions, and notes before installing or servicing equipment.
 - Keep the accessory cabinet doors closed and front panels installed to ensure proper cooling airflow and to protect personnel from dangerous voltages inside the unit.
 - Do not install or operate the UPS system close to gas or electric heat sources.
 - The operating environment should be maintained within the parameters stated in this manual.
 - Keep surroundings uncluttered, clean, and free from excess moisture.
 - Observe all DANGER, WARNING, and CAUTION notices affixed to the inside and outside of the equipment.
-

Chapter 3 Installation Plan and Unpacking

3.1 Installation Plan and Unpacking

Use the following basic sequence of steps to install the Eaton 93PM Integrated Accessory Cabinet-Power Distribution (IAC-PD):

1. Create an installation plan for the IAC-PD.
2. Prepare your site for the IAC-PD.
3. Inspect and unpack the IAC-PD.
4. Unload and install the IAC-PD, and wire the system.
5. Complete the Installation Checklist.
6. Have authorized service personnel perform preliminary operational checks and start up the UPS system.



NOTE

Startup and operational checks must be performed by an authorized Eaton Customer Service Engineer, or the warranty terms specified in paragraph [9.1 Warranty](#) become void. This service is offered as part of the sales contract for the UPS. Contact an Eaton service representative in advance (usually a two-week notice is required) to reserve a preferred startup date.

3.1.1 Creating an Installation Plan

Before installing the IAC-PD, read and understand how this manual applies to the system being installed. Use the procedures and illustrations in this section to create a logical plan for installing the IAC-PD. This section contains the following information:

- Physical features and requirements, including dimensions
- Power wiring installation information

3.2 Preparing the Site

For the UPS system to operate at peak efficiency, the installation site should meet the environmental parameters outlined in this manual. The operating environment must meet the weight, clearance, and environmental requirements specified for the applicable accessory cabinet.

3.2.1 Environmental and Installation Considerations

The UPS system installation, including the IAC-PD, must meet the following guidelines:

- The system must be installed on a level floor suitable for computer or electronic equipment.
- The system must be operated at an altitude no higher than 1500m (5000 ft) without derating. For additional assistance with high altitude operation, contact an Eaton service representative (see paragraph [1.8 Getting Help](#)).
- The system must be installed in a temperature and humidity controlled indoor area free of conductive contaminants.
- Failure to follow guidelines may void your warranty.

The basic environmental requirements for operation of the IAC-PD are:

- Recommended Operating Range: 5–40°C (41–104°F)
- Maximum Relative Humidity: 5–95%, noncondensing

The IAC-PD operating environment must accommodate the weight requirements shown in [Table 1](#) and the size and space requirements shown in [Table 2](#) and [Figure 6](#) through [Figure 8](#).

Table 1. IAC-PD Cabinet Weights

Model	Weight kg (lb)		
	Shipping	Installed	Point Loading
Eaton 93PM IAC-PD with (2) 400A Panelboards	342 (753.3)	311 (686.3)	4 at 78 (172)
Eaton 93PM IAC-PD with (1) 400A Panelboard and (2) 400A Subfeed Breakers	336 (740.1)	305 (673.1)	4 at 76 (168)
Eaton 93PM IAC-PD with (1) 400A Panelboard and (3) 250A Subfeed Breakers	330 (725.5)	299 (658.5)	4 at 75 (165)
Eaton 93PM IAC-PD with (4) 400A Subfeeds Breakers	332 (730.1)	301 (663.1)	4 at 75 (166)
Eaton 93PM IAC-PD with (1) 400A Panelboard [Cab top empty]	314 (691.8)	283 (624.8)	4 at 227 (501)
Eaton 93PM IAC-PD with (2) 400A Subfeed Breakers [Cab top empty]	309 (680.5)	278 (613.5)	4 at 244 (539)

Air inlets are in the front bottom of the cabinet. Outlets are in the back of the cabinet for the rear ventilation option or in the top of the cabinet for the top ventilation option.

Convection air cooling regulates internal component temperature through either of the following configurations:

- Rear ventilation (see [Figure 9](#)).
- Top ventilation (see [Figure 10](#)).

Allow clearance on top or in back of the cabinet depending on type of ventilation for proper air circulation. The clearances required around the IAC-PD cabinet are shown in [Table 2](#).

Table 2. IAC-PD Cabinet Clearances

Viewing the IAC-PD	Clearance
From Front of Cabinet	914.4 mm (36") working space
From Top of Cabinet with Top Venting	203 mm (8") minimum clearance for ventilation*
From Top of Cabinet with Rear Venting	203 mm (8") *
From Back of Cabinet with Rear Venting	203 mm (8") minimum clearance for ventilation
From Back of Cabinet with Top Venting	None Required
From Right Side of Cabinet	None Required
From Left Side of Cabinet	None Required

NOTE *Additional Top of Cabinet clearance may be required for conduit in top entry applications.

Figure 6. 93PM IAC-PD Cabinet Dimensions (Front, Right Side, and Back Views)

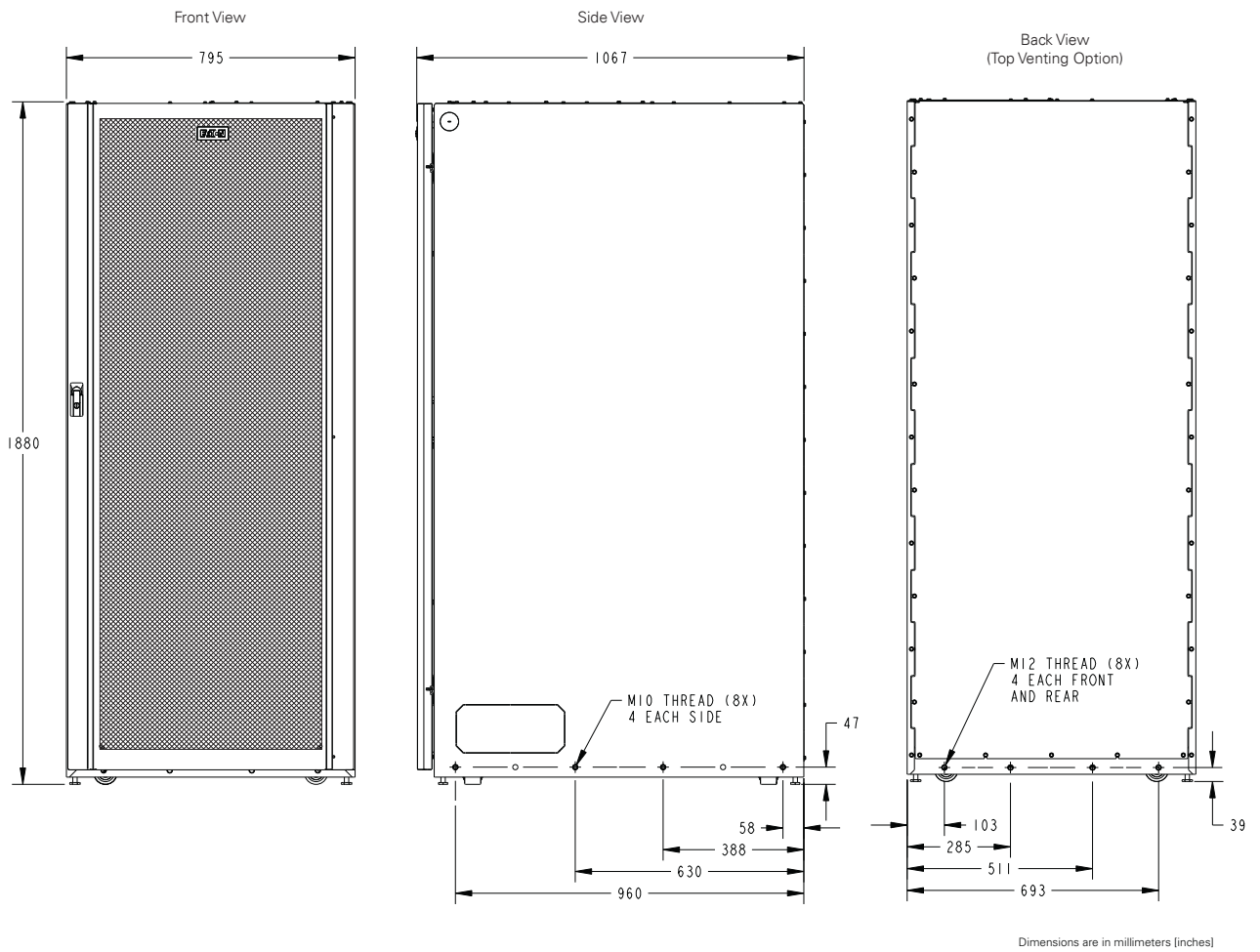

Figure 7. 93PM IAC-PD Dimensions (Top and Bottom Views)

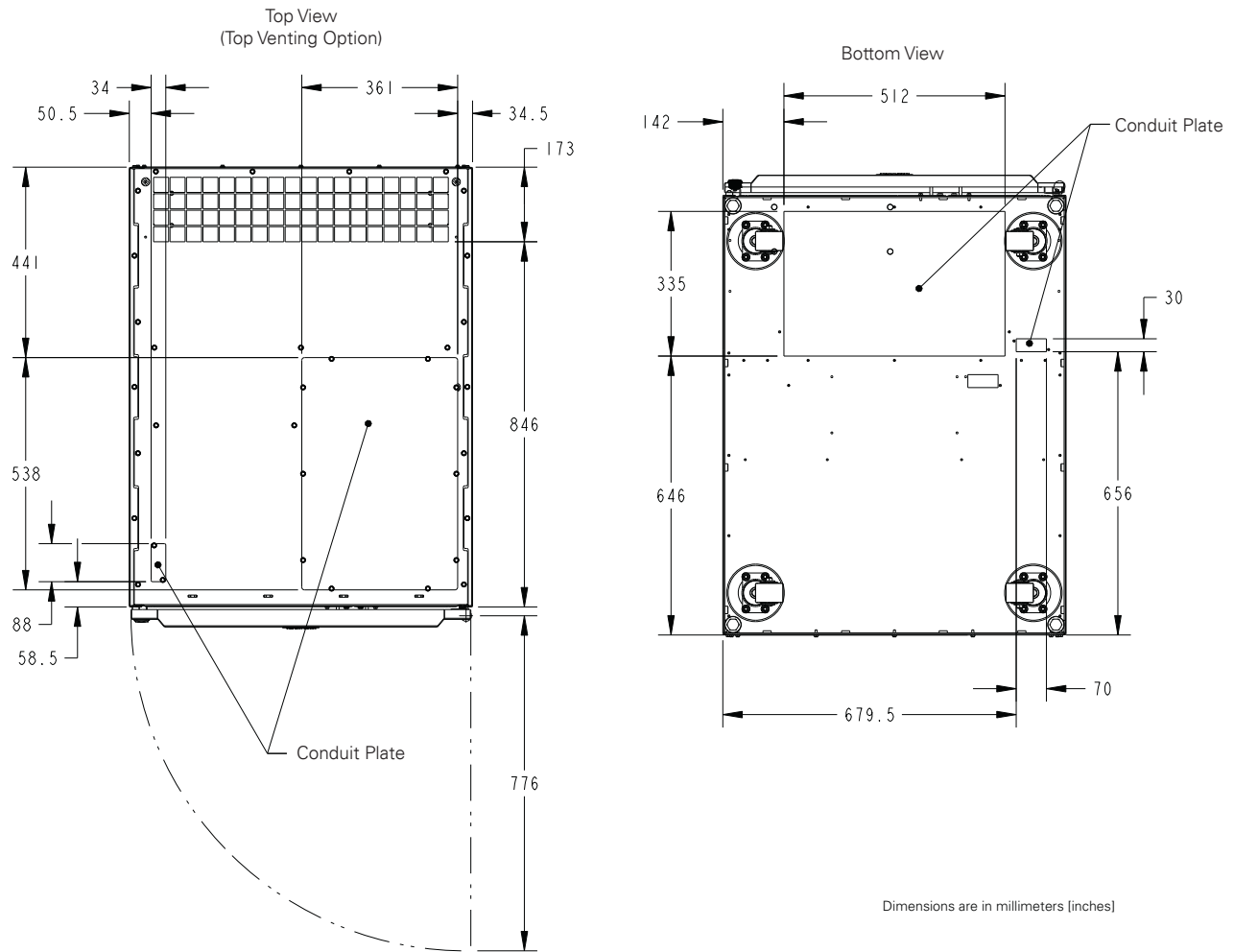

Figure 8. 93PM IAC-PD Center of Gravity

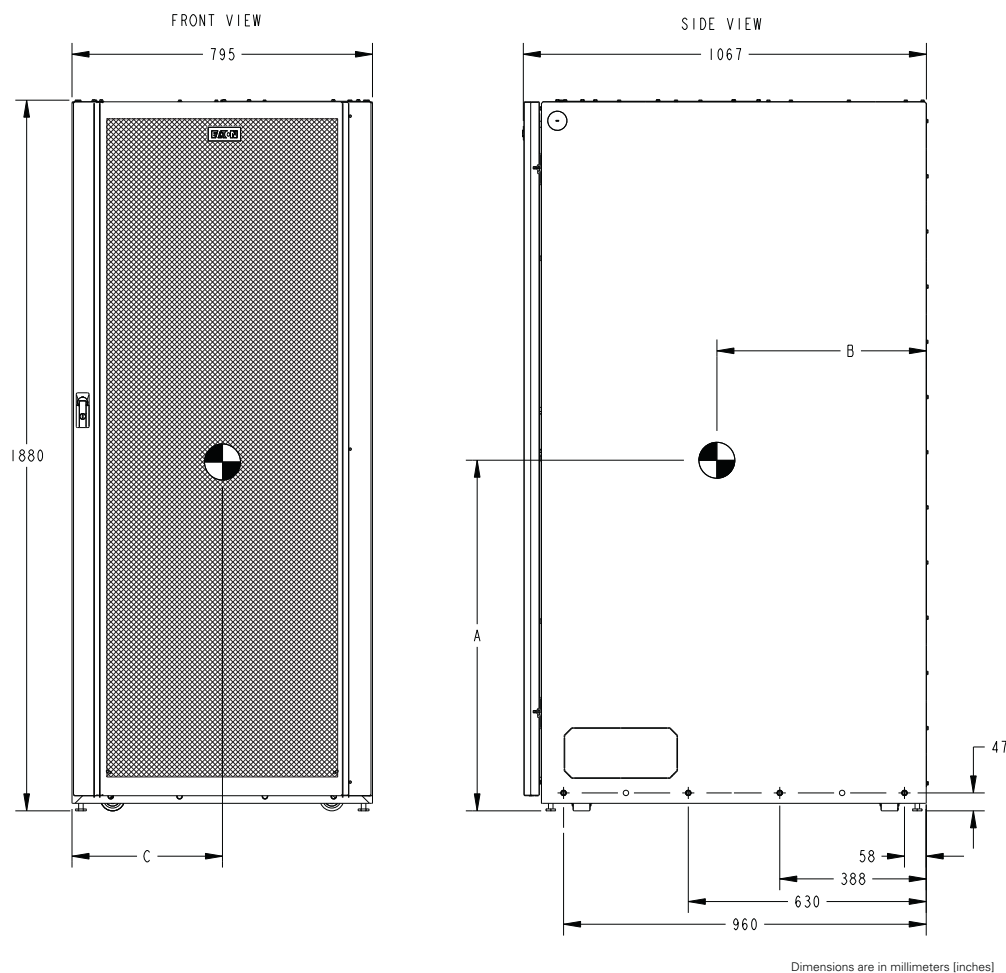

Table 3. IAC-PD Weight and Center of Gravity Dimensions

IAC-PD Configuration	A mm [inch]	B mm [inch]	C mm [inch]	Weight kg [lbs]
Eaton 93PM IAC-PD with (2) 400A Panelboards	922 [36.3]	604 [23.8]	377 [14.8]	311 [686.3]
Eaton 93PM IAC-PD with (1) 400A Panelboard and (2) 400A Subfeed Breakers	922 [36.3]	601 [23.7]	380 [15.0]	305 [673.1]
Eaton 93PM IAC-PD with (1) 400A Panelboard and (3) 250A Subfeed Breakers	912 [35.9]	598 [23.5]	380 [15.0]	299 [658.5]
Eaton 93PM IAC-PD with (4) 400A Subfeeds Breakers	935 [36.8]	599 [23.6]	373 [14.7]	301 [663.1]
Eaton 93PM IAC-PD with (1) 400A Panelboard [Cab top empty]	875 [34.5]	588 [23.2]	387 [15.2]	283 [624.8]
Eaton 93PM IAC-PD with (2) 400A Subfeed Breakers [Cab top empty]	890 [35.0]	586 [23.1]	391 [15.4]	278 [613.5]

Figure 9. Cabinet Ventilation – Rear Venting

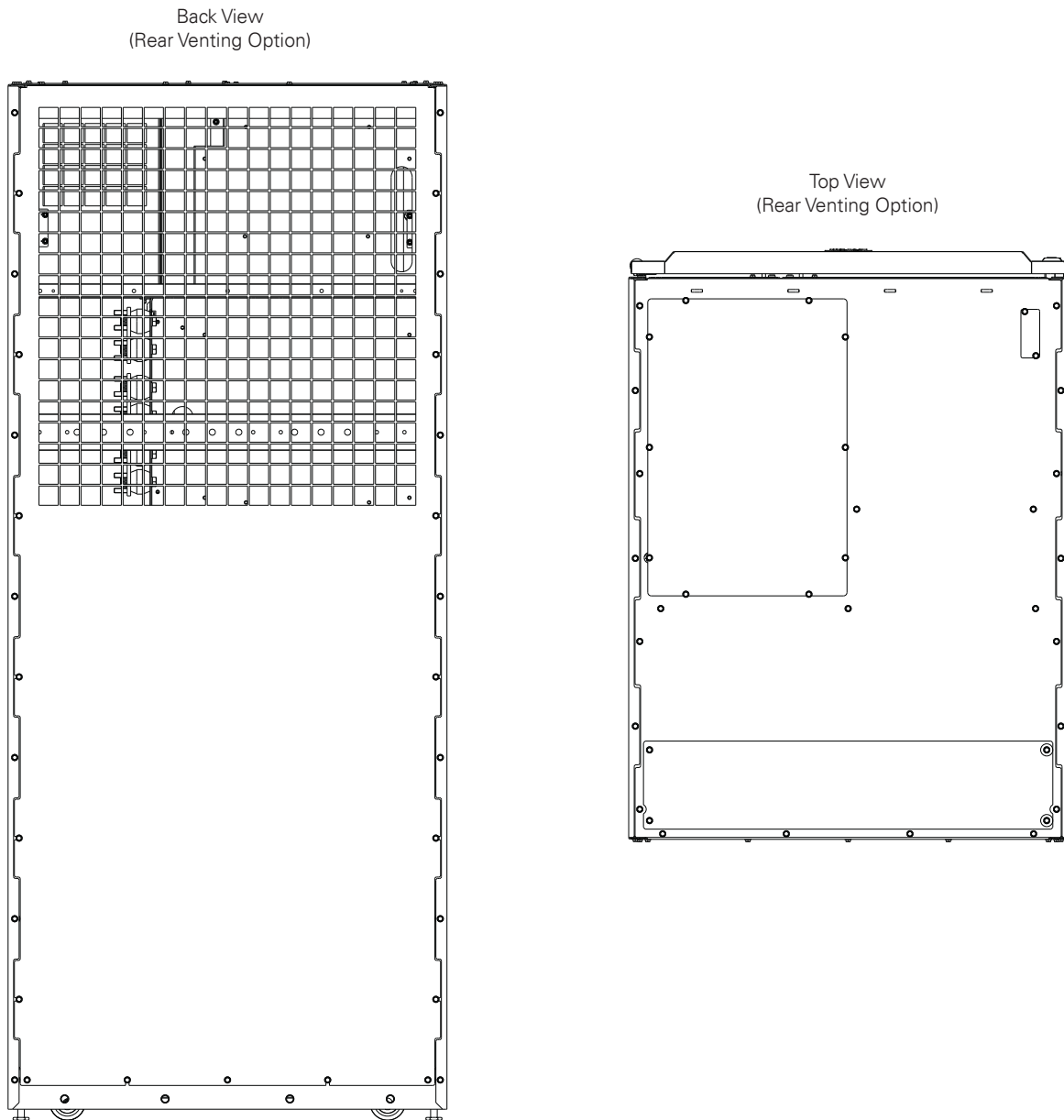
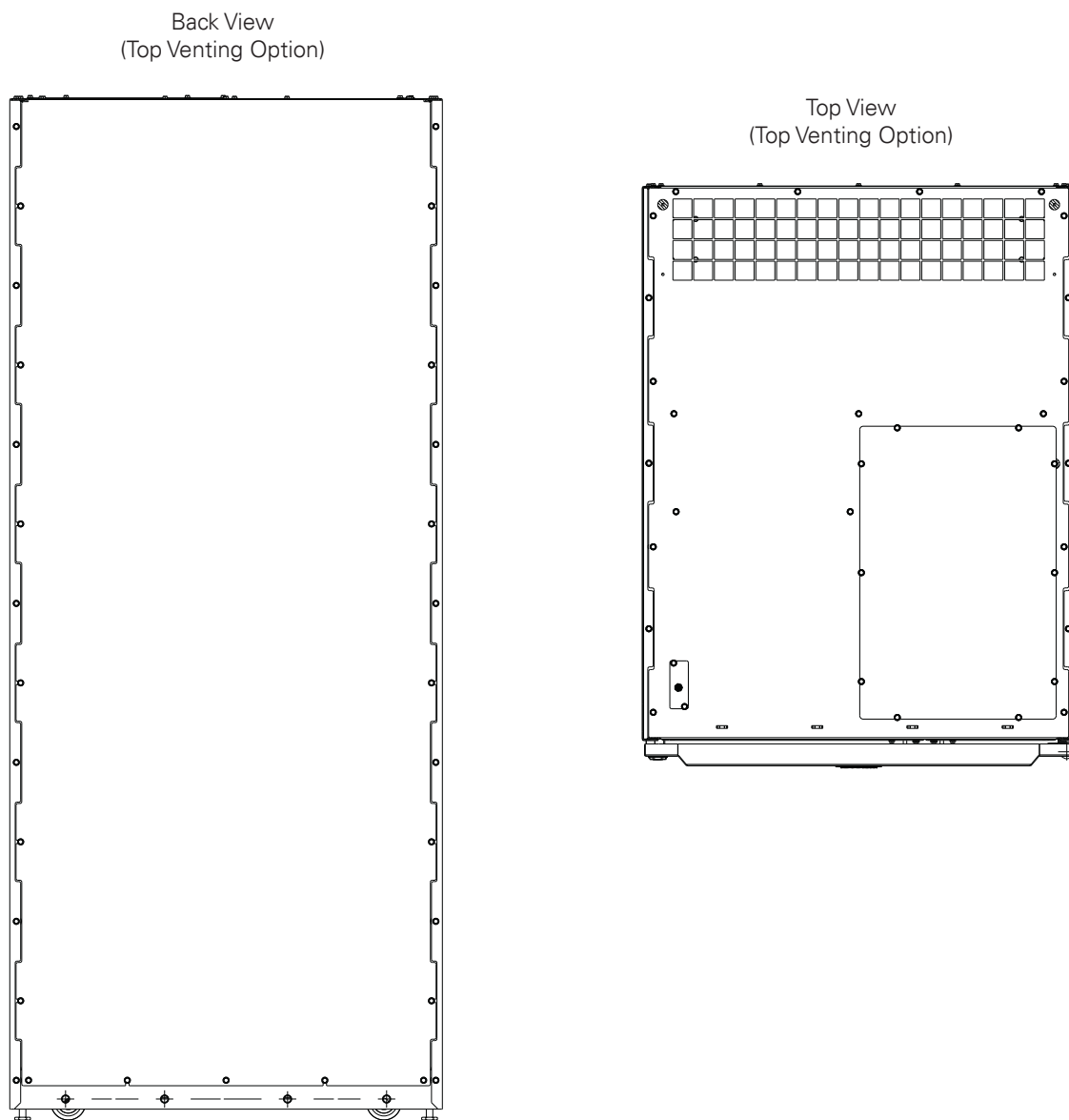

Figure 10. Cabinet Ventilation – Top Venting



3.2.2 IAC-PD Power Wiring Preparation

Read and understand the following information while planning and performing the installation:

 **WARNING**

As a result of the connected loads, high leakage current is possible. Connection to earth ground is required for safety and proper product operation. Do not check IAC-PD operation by any action that includes removal of the earth (ground) connection with loads attached.

- Refer to national and local electrical codes for acceptable external wiring practices.
 - For external wiring, use copper wire with 75°C rated insulation. Wire sizes listed in [Table 5](#) and [Table 6](#) are for copper wiring only. If wire is run in an ambient temperature greater than 40°C (104°F), higher temperature wire and/or larger size wire may be necessary. Wire sizes are based on using the specified breakers.
-

 **IMPORTANT**

This product has been evaluated for use with **copper wire** only. For external wiring, use only 75°C copper wire.

- Recommended wire sizes are based on NFPA National Electrical Code® (NEC®) 70 Table 310.15(B)(16) 75° C ampacity with 40°C ambient correction factors.
- Refer to NEC Article 250 and local codes for proper grounding practices.
- Per NEC Article 300-20(B), all three-phase conductors must be run in the same conduit. Neutral and ground must be run in the same conduit as the phase conductors.
- Conduit is to be sized to accommodate three phase conductors, one neutral conductor the same size as the phase conductors and one ground conductor. If two neutral conductors or an oversized neutral conductor are to be installed, size the conduit to accommodate the extra wire or size.
- Distribution panels use branch circuit breakers provided by the customer.
- Material and labor for external wiring requirements are to be provided by the customer.
- Refer to the appropriate Eaton 93PM UPS manual listed in paragraph [1.7 For More Information](#) for UPS cabinet conduit and terminal specifications and locations.
- The term *line-up-and-match* refers to accessory cabinets that are physically located adjacent to the UPS. The term *standalone* refers to accessory cabinets that are located separate from the UPS.

Table 4. IAC-PD Input Device Specification

Configuration Description	Device Model	AC Input Voltage (V)	Maximum AC Input Current (A)	AC Output Voltage (V)	Maximum AC Output Current (A)
IAC-PD Connected to a 93PM 208V UPS	93PM-L 60 kW UPS	208	167	208	
	93PM-L 120 kW UPS		333		
	93PM-L 160 kW UPS		444		
	93PM-L 200 kW UPS		555		
IAC-PD Connected to a IAC-D or IAC-BD Subfeed Breaker	93PM IAC-D 93PM IAC-BD	208	250	208	
IAC-PD Connected to a IAC-D Output Breaker (with no Distribution Option). IAC-D is Fed From a 93PM 480V UPS	IAC-D fed from 93PM 50 kVA UPS	208	139	208	See Notes
	IAC-D fed from 93PM 100 kVA UPS		277		
	IAC-D fed from 93PM 150 kVA UPS		416		
	IAC-D fed from 93PM 200 kVA UPS		555		
IAC-PD Connected Directly to a 93PM 480V UPS	93PM 50 kVA UPS	480	60	480	
	93PM 100 kVA UPS		120		
	93PM 150 kVA UPS		180		
	93PM 200 kVA UPS		240		
	93PM 400 kVA UPS		480		

NOTE Additional details on IAC-PD Input and Output Ratings:

- IAC-PD input current and voltage is based on the output from the device feeding the IAC-PD. Refer to the input device specifications found in [Table 5](#) to determine the maximum input voltage and current for the IAC-PD application.
- The AC output current is based on the output of the distribution option of the input current available from the device powering the IAC-PD. Select the lower of the two values. For further detail, see the example situations below:
- **Example 1:** IAC-PD used with the 400kVA UPS, which has an output current availability of 480A. If the IAC-PD selected contains (2) 400A subfeeds, the 480A available UPS current would be the limiting factor for the output current of the IAC-PD.
- **Example 2:** IAC-PD used with the 120kVA 93PM-L UPS, which has an output current availability of 333A. If the IAC-PD selected contains (1) 225A panelboard, the 225A available from the panel would be the maximum output current, and so the IAC-PD configuration would be the limiting factor.

Table 5. IAC-PD Input Power Wiring Recommendations

Input Current [A]	Customer Wiring	Accepted Wire Range	Torque Rating N*M [IN-LB]	Recommended Minimum Wire Size For 75° C Copper Stranded Wire	Recommended Conduit (Qty) Size (Inches)
60	208V Input Phase Wire	Customer Supplied Long Barrel 2-Hole Lug	-	(1) #2	(1) 1.5"
	Input Neutral Wire See Note	Customer Supplied Long Barrel 2-Hole Lug	-	(2) #3	
	Ground	14 AWG TO 1/0	5.1 [45]	(1) #8	
120	208V Input Phase Wire	Customer Supplied Long Barrel 2-Hole Lug	-	(1) 4/0	(1) 2.5"
	Input Neutral Wire See Note	Customer Supplied Long Barrel 2-Hole Lug	-	(2) 3/0	
	Ground	14 AWG TO 1/0	5.1 [45]	(1) #6	
139	Input Phase Wire	Customer Supplied Long Barrel 2-Hole Lug	-	(1) 250 MCM	(1) 2.5"
	Input Neutral Wire See Note	Customer Supplied Long Barrel 2-Hole Lug	-	(2) 4/0	
	Ground	14 AWG TO 1/0	5.1 [45]	(1) #6	
167	Input Phase Wire	Customer Supplied Long Barrel 2-Hole Lug	-	(1) 350 MCM	(1) 3"
	Input Neutral Wire See Note	Customer Supplied Long Barrel 2-Hole Lug	-	(2) 300 MCM	
	Ground	14 AWG TO 1/0	5.1 [45]	(1) #4	
180	Input Phase Wire	Customer Supplied Long Barrel 2-Hole Lug	-	(1) 400 MCM	(1) 3"
	Input Neutral Wire See Note	Customer Supplied Long Barrel 2-Hole Lug	-	(2) 300 MCM	
	Ground	14 AWG TO 1/0	5.1 [45]	(1) #4	

Table 5. IAC-PD Input Power Wiring Recommendations (Continued)

Input Current [A]	Customer Wiring	Accepted Wire Range	Torque Rating N*M [IN-LB]	Recommended Minimum Wire Size For 75° C Copper Stranded Wire	Recommended Conduit (Qty) Size (Inches)
240 250	Input Phase Wire	Customer Supplied Long Barrel 2-Hole Lug	-	(2) 4/0	(2) 2.5"
	Input Neutral Wire See Note	Customer Supplied Long Barrel 2-Hole Lug	-	(4) 3/0	
	Ground	14 AWG TO 1/0	5.1 [45]	(2) #6	
277	Input Phase Wire	Customer Supplied Long Barrel 2-Hole Lug	-	(2) 250 MCM	(2) 2.5"
	Input Neutral Wire See Note	Customer Supplied Long Barrel 2-Hole Lug	-	(4) 4/0	
	Ground	14 AWG TO 1/0	5.1 [45]	(2) #6	
333	Input Phase Wire	Customer Supplied Long Barrel 2-Hole Lug	-	(2) 350 MCM	(2) 3"
	Input Neutral Wire See Note	Customer Supplied Long Barrel 2-Hole Lug	-	(4) 300 MCM	
	Ground	14 AWG TO 1/0	5.1 [45]	(2) #4	
416	Input Phase Wire	Customer Supplied Long Barrel 2-Hole Lug	-	(3) 250 MCM	(3) 2.5"
	Input Neutral Wire See Note	Customer Supplied Long Barrel 2-Hole Lug	-	(6) 4/0	
	Ground	14 AWG TO 1/0	5.1 [45]	(3) #6	
444	Input Phase Wire	Customer Supplied Long Barrel 2-Hole Lug	-	(3) 300 MCM	(3) 3"
	Input Neutral Wire See Note	Customer Supplied Long Barrel 2-Hole Lug	-	(6) 4/0	
	Ground	14 AWG TO 1/0	5.1 [45]	(3) #6	

Table 5. IAC-PD Input Power Wiring Recommendations (Continued)

Input Current [A]	Customer Wiring	Accepted Wire Range	Torque Rating N*M [IN-LB]	Recommended Minimum Wire Size For 75° C Copper Stranded Wire	Recommended Conduit (Qty) Size (Inches)
480	Input Phase Wire	Customer Supplied Long Barrel 2-Hole Lug	-	(3) 300 MCM	(3) 3"
	Input Neutral Wire See Note	Customer Supplied Long Barrel 2-Hole Lug	-	(6) 250 MCM	
	Ground	14 AWG TO 1/0	5.1 [45]	(3) #6	
555	Input Phase Wire	Customer Supplied Long Barrel 2-Hole Lug	-	(3) 400 MCM	(3) 3"
	Input Neutral Wire See Note	Customer Supplied Long Barrel 2-Hole Lug	-	(6) 300 MCM	
	Ground	14 AWG TO 1/0	5.1 [45]	(3) #4	

NOTE Neutral is not present on 480V 3-wire cabinets.

Table 6. IAC-PD Output Power Wiring Recommendations (Panelboards and Subfeeds)

Type	Customer Wiring	Accepted Wire Range	Torque Rating N*M (IN-LB)		Recommended Minimum Wire Size For 75° C Copper Stranded Wire
250A Subfeeds	Output Phase Wire	(1) 6 AWG TO 500 MCM	20 [177]		See Note 2
	Output Neutral Wire See Note 1	Customer Supplied Long Barrel 2-Hole Lug See Note 2	-		
	Ground	14 AWG TO 1/0	5.1 [45]		
400A Subfeeds	Output Phase Wire	(2) 6 AWG TO 500 MCM	20 [177]		
	Output Neutral Wire See Note 1	Customer Supplied Long Barrel 2-Hole Lug See Note 2	-		
	Ground	14 AWG TO 1/0	5.1 [45]		
208V 225A Panelboards	Output Neutral Wire See Note 1	(64) 6 AWG TO 14 AWG	6 TO 8 AWG	2.8 [25]	
			10 TO 14 AWG	1.7 [15]	
			1/0 TO 2 AWG	5.7 [50]	
			(22) 1/0	4 TO 6 AWG	
			8 AWG	4.5 [40]	
			10 TO 14 AWG	4.0 [35]	
208V 400A Panelboards	Output Neutral Wire See Note 1	(32) 6 AWG TO 14 AWG	6 TO 8 AWG	2.8 [25]	
			10 TO 14 AWG	1.7 [15]	
480V 225A Panelboards	Ground	(11) 1/0	1/0 TO 2 AWG	5.7 [50]	
			4 TO 6 AWG	5.0 [45]	
			8 AWG	4.5 [40]	
			10 TO 14 AWG	4.0 [35]	
			10 TO 14 AWG	4.0 [35]	

NOTE

1. Neutral is not present on 480V 3-Wire Cabinets
2. Wire per NFPA 70: National Electric Code for selected circuit breaker trip rating

Table 7. IAC-PD Fuse and Breaker Details

Breaker Application	Electrical Specifications	Manufacturer
Panel Main Breaker, 225A Panelboard	208V, 480V 3-Wire, 480V 4-Wire	Eaton
Panel Main Breaker, 400A Panelboard	208V	Eaton
250A Subfeed Distribution Options	208V, 480V 3-Wire, 480V 4-Wire	Eaton
400A Subfeed Distribution Options	208V, 480V 3-Wire, 480V 4-Wire	Eaton

NOTE The information required for performing arc-flash analysis (Panel Main Breakers and Subfeed Distribution Breaker part numbers) can be found in the *Eaton 93PM IAC-PD Site Plan*. For additional assistance contact an Eaton service representative (see paragraph [1.8 Getting Help](#)).

External 208 Vac input overcurrent protection and disconnect are not provided by the 208V/208V IAC-PD model, but are required by codes. Overcurrent protection and disconnect are to be supplied by the customer. Refer to [Table 5](#) and [Table 6](#) for wiring requirements.

[Table 8](#) lists the recommended rating for the 208 Vac input circuit breaker.

Table 8. Recommended 208 Vac Input Circuit Breaker Rating

IAC-PD Model	Input Rating	
	Load Rating	208V
Eaton 93PM IAC-PD	80% Rated	250A
	100% Rated	200A
	80% Rated	400A
	100% Rated	375A

 **CAUTION**

To reduce the risk of fire, connect only to a circuit provided with maximum input circuit breaker current ratings from [Table 8](#) in accordance with the NEC, ANSI/NFPA 70.

3.3 Inspecting and Unpacking the IAC-PD

The cabinet is shipped bolted to a metal and wood pallet and covered with outer protective packaging material (see [Figure 11](#)).

NOTE  Startup and operational checks must be performed by an authorized Eaton Customer Service Engineer, or the warranty terms specified in paragraph [9.1 Warranty](#) become void. This service is offered as part of the sales contract for the UPS. Contact an Eaton service representative in advance (usually a two-week notice is required) to reserve a preferred startup date.

 **WARNING**

The IAC-PD is heavy (see [Table 1](#)). If unpacking and unloading instructions are not closely followed, the cabinet may tip and cause serious injury. Do not tilt the IAC-PD more than 10° from vertical or the cabinet may tip over. Failure to follow these instructions may result in serious injury or death.

- Carefully inspect the outer packaging for evidence of damage during transit.

 **CAUTION**

Do not install a damaged cabinet. Report any damage to the carrier and contact an Eaton service representative immediately.

NOTE  For the following step, verify that the forklift or pallet jack is rated to handle the weight of the cabinet.

- Use a forklift or pallet jack to move the packaged cabinet to the installation site, or as close as possible, before unpacking. If possible, move the cabinet using the pallet. Insert the forklift or pallet jack forks between the supports on the bottom of the pallet (see [Table 3](#) for the IAC-PD cabinet center of gravity measurements).

 **CAUTION**

Do not tilt the IAC-PD more than 10° from vertical or the cabinet may tip over.

- Set the pallet on a firm, level surface, allowing a minimum clearance of 3m (10 ft) on each side for removing the cabinet from the pallet.
- Remove the protective packaging material from the cabinet and recycle in a responsible manner. Retain the parts kit box packed inside the cabinet.
- Inspect the contents for any evidence of physical damage, and compare each item with the Bill of Lading. If damage has occurred or shortages are evident, contact an Eaton service representative immediately to determine the extent of the damage and its impact on further installation.

NOTE  While waiting for installation, protect the unpacked cabinet from moisture, dust, and other harmful contaminants. Failure to store and protect the IAC-PD properly may void your warranty.

Figure 11. Eaton 93PM IAC-PD as Shipped on Metal and Wood Pallet



Chapter 4 Installation

4.1 Installation

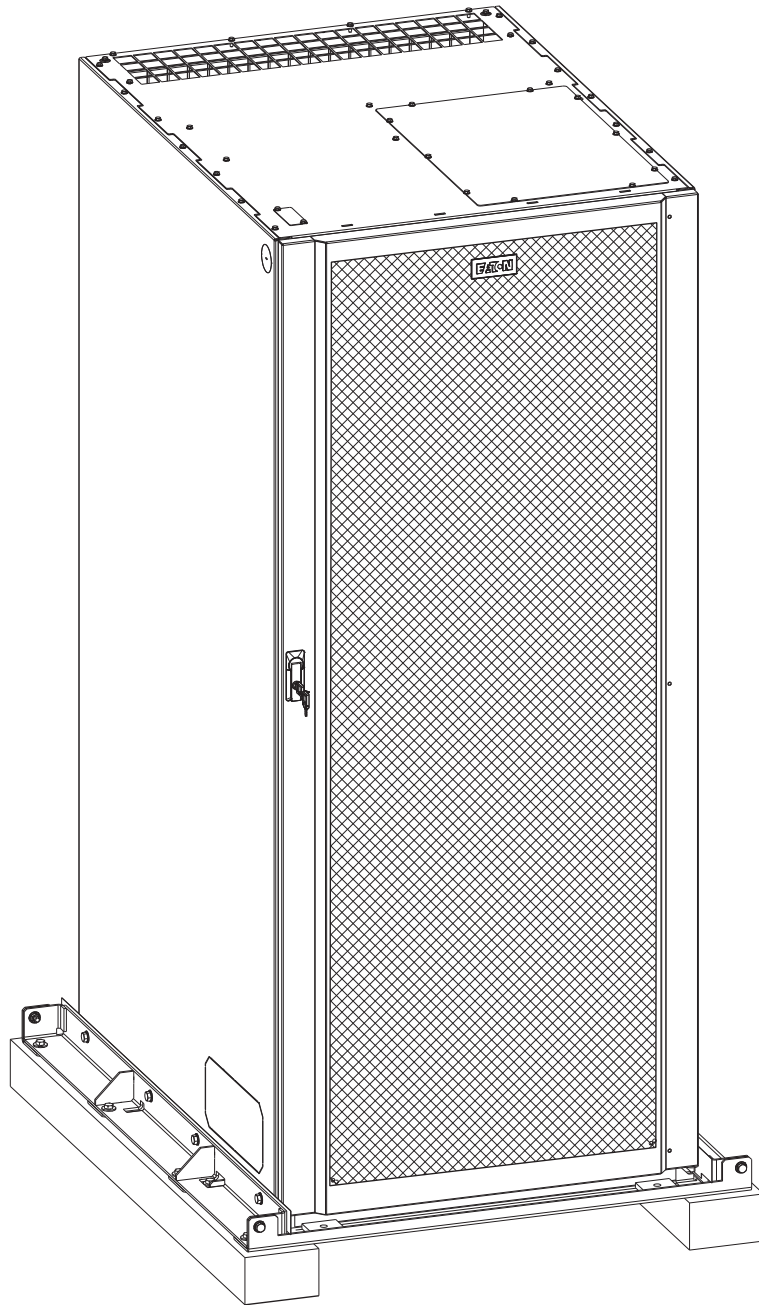
4.1.1 Preliminary Installation Information



Installation should be performed only by qualified personnel.

When installing the Eaton 93PM Integrated Accessory Cabinet-Power Distribution (IAC-PD):

- Review **Chapter 3 Installation Plan and Unpacking** for cabinet dimensions, equipment weight, wiring and terminal data, and installation notes.
- Do not tilt the IAC-PD more than 10° from vertical or the cabinet may tip over.
- Remove conduit landing plates to add conduit landing holes as required.

4.2 Unloading the IAC-PD Cabinet from the Pallet



RISK OF INSTABILITY. Do not remove any internal panels until the cabinet is removed from and lowered from the pallet.



-
- The IAC-PD is heavy (see [Table 1](#)).
 - Do not tilt the cabinet more than 10° from vertical.
 - Lift the cabinets only with a forklift or pallet jack or damage may occur.
 - Ensure the forklift is rated to handle the weight of the cabinet.

Failure to follow these instructions may result in serious injury or death.

**NOTE**

Before performing the IAC-PD unloading, verify that the forklift or pallet jack is rated to handle the weight of the cabinet.

The IAC-PD is bolted to a pallet consisting of two metal angle supports and two flat supports secured to two wood supports.

To remove the pallet:

1. If not already accomplished, use a forklift or pallet jack to move the IAC-PD to the installation area, or as close as possible, before unloading from the pallet. Insert the forklift or pallet jack forks between the supports on the bottom of the pallet (see [Table 3](#) for the IAC-PD cabinet center of gravity measurements).
2. Open the front door by lifting the latch from the bottom and turning to the right (counterclockwise) and swing the door open.
3. Locate the four 1/2" jacking bolts from the parts bag packed inside the front door and install them in the threaded holes in the front and rear supports as shown in [Figure 12](#). Place a floor protector from the parts kit underneath each jacking bolt, and screw the bolts down against them.

The floor protectors protect the floor from being marred by the jacking bolts.

- Loosen, but do not remove, the skid mounting bolts holding the left, right, front, rear, and two center supports to the pallet skids. **DO NOT** loosen or remove the cabinet mounting bolts or the cabinet support bolts.

Figure 12. Removing the Pallet Skids and Supports – Eaton 93PM IAC-PD

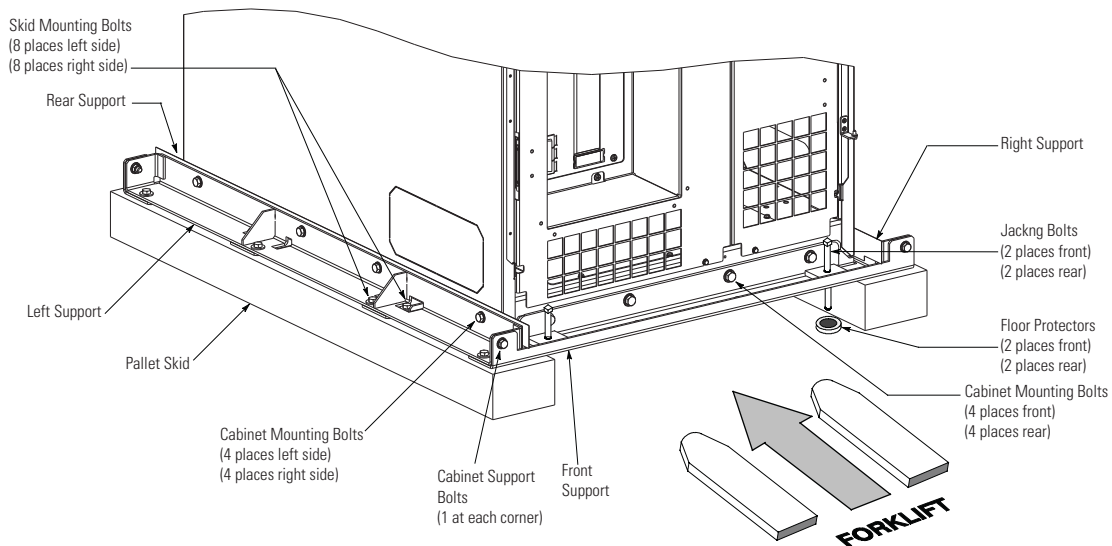

WARNING

RISK OF INSTABILITY. Turning the jacking bolts unevenly may cause the cabinet to become unbalanced. To prevent tipping the cabinet, raise the cabinet no more than 3 mm (1/8") above the floor (just enough to allow the removal of the pallet skids). Failure to follow these instructions can result in serious injury or death.

- Turn each jacking bolt consecutively, two full turns, until the pallet skids clear the floor by approximately 3 mm (1/8").

NOTE In the following step the center supports will drop away from the cabinet and the pallet skids when the skids are removed.

- Remove the hardware loosened in [Step 4](#). Pull the two pallet skids out from under the left, right, front, rear, and two center supports. Recycle the pallet skids, supports, and hardware in a responsible manner.

CAUTION

CABINET MAY FALL. Do not loosen the hardware attaching the front supports to the cabinet base. The cabinet must be lowered by the jacking bolts before the supports can be removed.

- Carefully and evenly **lower the cabinet by turning each jacking bolt consecutively two full turns (maximum)** until the casters contact the floor and the cabinet is no longer supported by the jacking bolts.
- After the IAC-PD is resting on the floor, remove the jacking bolts and floor protectors. Recycle them in a responsible manner.

9. Remove the cabinet support bolts fastening the left, right, front, and rear supports together.
10. Remove the cabinet mounting bolts holding the left, right, front, and rear supports to the cabinet base and remove the supports.
11. If installing the cabinet permanently, retain the cabinet mounting bolts; otherwise, recycle the bolts along with the support brackets in a responsible manner.
12. Close the door and secure the latch.
13. If the leveling feet are not retracted, turn all four leveling feet until they are retracted as far into the cabinet as possible.



NOTE

The IAC-PD may be located to either the right or left of the UPS cabinet. This procedure assumes the IAC-PD is located to the left of the UPS cabinet.

14. If line-up-and-match installation, remove the rectangular knockouts from the lower sides of the UPS and the IAC-PD (see [Figure 13](#)).



CAUTION

To prevent tipping when rolling the cabinet, push the cabinet from the rear whenever possible.

15. Roll the IAC-PD to the line-up-and-match installation location on the left side of the UPS cabinet making sure the doors are flush with each other or to the standalone installation location.
16. Lower the cabinet's leveling feet and using a bubble level, adjust the leveling feet accordingly until the cabinet is level and aligned with adjacent cabinet.
17. Locate the top splice bracket shipped with the IAC-PD.
18. Remove the screws along each adjacent cabinet top panel securing the top panels. Retain the hardware for later use.
19. Install the top splice bracket between the adjacent cabinet and secure the tie strap with retained hardware.



NOTE

Optional front and back floor mounting brackets are available to order for permanently mounting the IAC-PD.

20. If permanently mounting the IAC-PD, proceed to [Step 21](#); otherwise, continue to [Step 24](#).
21. Locate the front and back floor mounting brackets from the optional floor mounting kit.
22. Using the cabinet mounting bolts from the kit, install the floor mounting brackets to the front and rear of the IAC-PD with the angle facing outward.
23. Secure the cabinet to the floor with customer-supplied hardware.
24. Proceed to paragraph [4.3 Installing IAC-PD External Power Wiring](#).

Figure 13. Line-Up-and-Match Wiring Access Locations

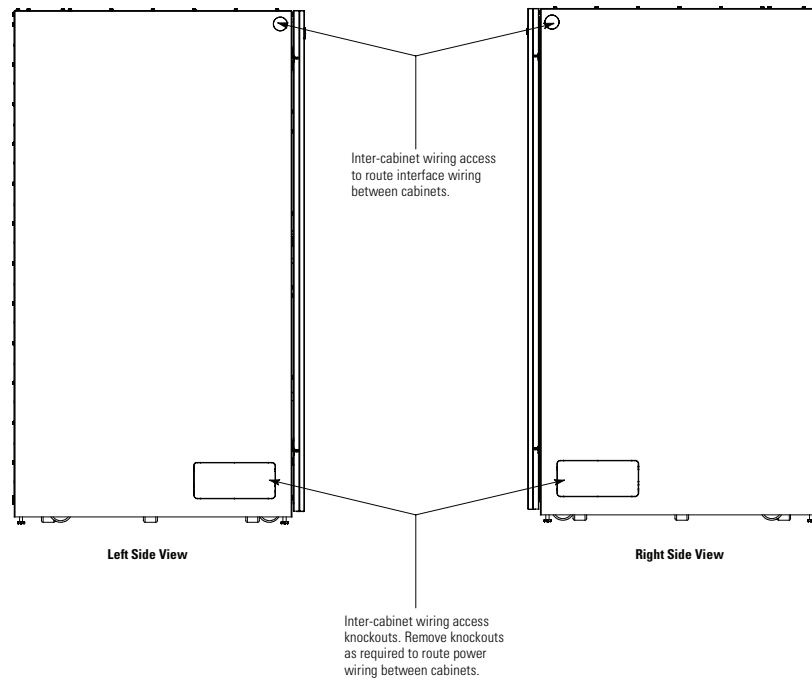
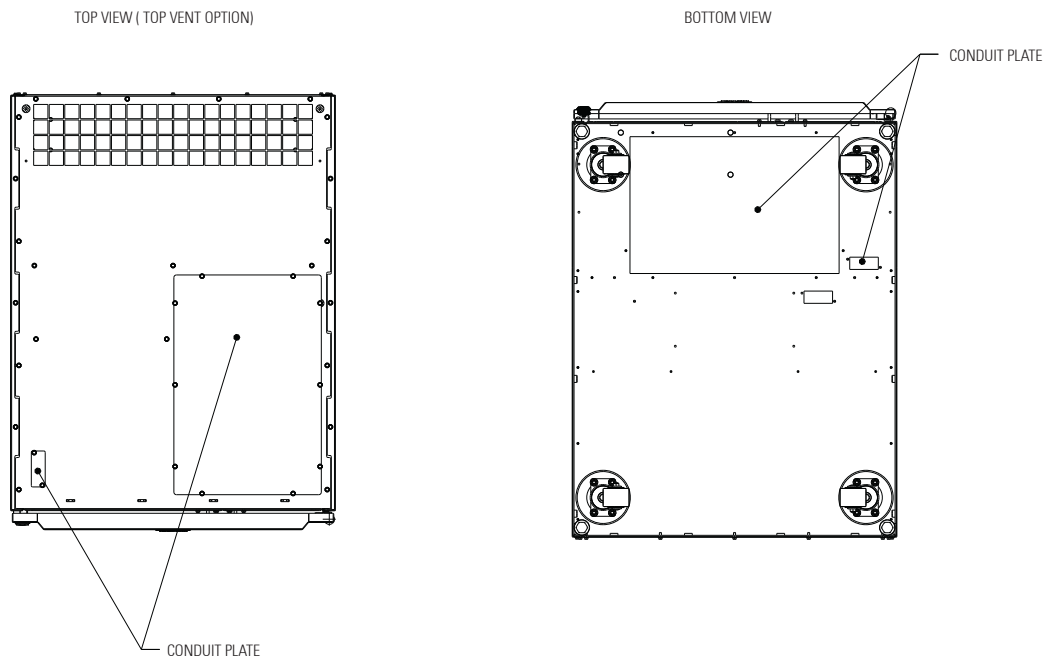

Figure 14. Top and Bottom Conduit Landing Wire Entry Locations



4.3 Installing IAC-PD External Power Wiring

4.3.1 Input Wiring

To install wiring to connections:



NOTE 1 Input power wiring is routed through the inside bottom of the IAC-PD and UPS for line-up-and-match configurations or wiring can be installed using conduit between the cabinets for standalone installations.

NOTE 2 Remove the IAC-PD conduit landing plates to drill or punch conduit holes, or remove knockouts in the conduit plate (see [Figure 14](#)).

1. Verify the UPS system is turned off and all power sources are removed. Refer to the appropriate Eaton 93PM UPS manual, listed in paragraph [1.7 For More Information](#), for the UPS shutdown instructions.
2. If not already open, open the front door by lifting the latch from the bottom and turning to the right (counterclockwise) and swing the door open.
3. Loosen the screws securing the inside distribution panel door and swing the door open.
4. Remove the screws securing the breaker trim plate and remove the plate. Retain trim plate and hardware for later use.
5. If wiring the IAC-PD input power terminals using the inter-cabinet wiring access pass-through (line-up-and-match configurations), proceed to [Step 6](#); if wiring the IAC-PD input power terminals using the bottom entry access, proceed to [Step 8](#); if wiring the IAC-PD input power terminals using the top entry access, proceed to [Step 11](#).
6. **Pass-through Wiring.** Route the IAC-PD input cables (phase A, B, C, Ground and Neutral [if 4-Wire]) from the UPS cabinet through the side UPS and IAC-PD inter-cabinet wiring access pass-through to the IAC-PD input terminals. See [Figure 13](#) for IAC-PD wiring access information and [Figure 15](#) for IAC-PD terminal locations. See paragraph [3.2.2 IAC-PD Power Wiring Preparation](#), [Table 5](#), and [Table 6](#) for IAC-PD wiring and termination recommendations. Refer to the applicable Eaton 93PM UPS manual, listed in paragraph [1.7 For More Information](#), for the UPS terminal locations and termination recommendations.
7. Proceed to [Step 13](#).
8. **Bottom Entry Wiring.** Remove the bottom conduit plate (see [Figure 14](#)) from the inside bottom of the IAC-PD. Identify all conduit recommendations (both input and output) and mark their location. Drill and punch all conduit holes in the bottom conduit plate prior to mounting on the IAC-PD. Install the conduit plate and install all conduit runs into the plate. Pull the wiring through conduit into the wiring area.
9. Route the input cables (phase A, B, C, Ground and Neutral [if 4-Wire]) from the UPS through the bottom of the cabinet to the IAC-PD input terminals. See [Figure 15](#) for IAC-PD terminal locations. Refer to the applicable Eaton 93PM UPS manual, listed in paragraph [1.7 For More Information](#), for the UPS terminal locations and termination recommendations.
10. Proceed to [Step 13](#).
11. **Top Entry Wiring.** Remove the top conduit plate (see [Figure 14](#)) from the top of the IAC-PD. Identify all conduit recommendations (both input and output) and mark their location. Drill and punch all conduit holes in the top conduit plate prior to mounting on the sidecar. Install the conduit plate and install all conduit runs into the plate. Pull the wiring through the conduit into the wiring area.
12. Route the input cables (phase A, B, C, Ground and Neutral [if 4-Wire]) from the UPS through the top of the cabinet to the IAC-PD input terminals. See [Figure 15](#) for IAC-PD terminal locations. Refer to the applicable Eaton 93PM UPS manual, listed in paragraph [1.7 For More Information](#), for the UPS terminal locations and termination recommendations.
13. Connect phase A, B, C, Ground and Neutral (if 4-Wire) power wiring to the corresponding input terminals on the IAC-PD.

Installing IAC-PD External Power Wiring

For a detailed view of the IAC-PD input terminals, see [Figure 15](#).

14. Connect phase A, B, C, Ground and Neutral (if 4-Wire) power wiring to the corresponding output terminals on the UPS.

Figure 15. Input Power Terminal Locations – 480V/208V

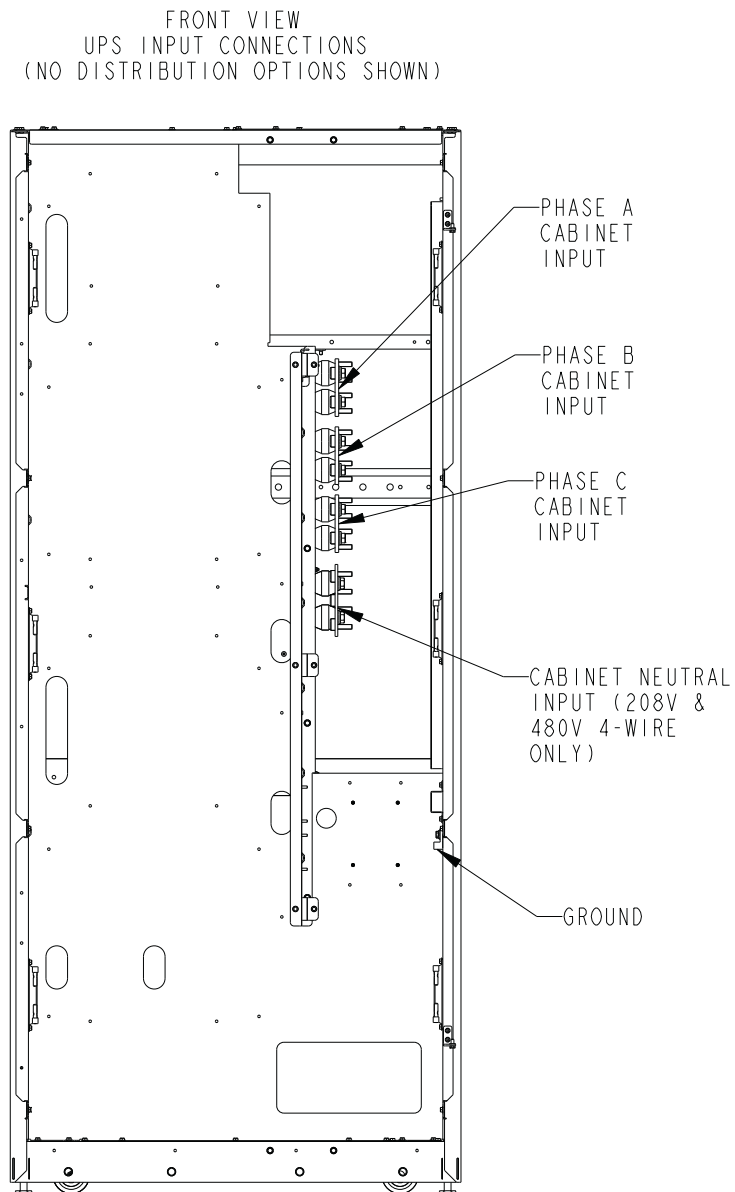

4.3.2 Output Wiring

To install wiring to connections:

1. If not already open, open the front door by lifting the latch from the bottom and turning to the right (counterclockwise) and swing the door open.
2. Loosen the screws securing the inside distribution panel door and swing the door open.
3. Remove the screws securing the breaker trim plate and remove the plate. Retain trim plate and hardware for later use.
4. If wiring an IAC-PD with distribution panels, continue to [Step 5](#); if wiring an IAC-PD with subfeed breakers, skip to [Step 8](#).
5. Install customer-supplied branch circuit breakers into the distribution panel (see [Figure 16](#) or [Figure 17](#)). Use Eaton bolt-on type BAB or QBHW breakers.



NOTE

When wiring branch circuits, begin adding conduits at the back of the bottom or top conduit landing plates to simplify future circuit additions.

6. Route output cables to the branch circuit breakers and wire according to the manufacturer's ratings and instructions, and national and local electrical codes (input is prewired to the panelboard). See [Figure 16](#) or [Figure 17](#) for neutral and ground terminal locations. See paragraph [3.2.2 IAC-PD Power Wiring Preparation](#), [Table 5](#), and [Table 6](#) for IAC-PD wiring and termination recommendations.
7. If wiring an IAC-PD with subfeed breakers, continue to [Step 8](#); otherwise, skip to [Step 11](#).



NOTE

When wiring subfeed branch circuits, begin adding conduits at the back of the bottom or top conduit landing plates to simplify future circuit additions.

8. Route output cables from subfeed breaker terminal blocks or output breaker to the critical load. See [Figure 17](#) or [Figure 19](#) for IAC-PD output, neutral, and ground terminal locations. See paragraph [3.2.2 IAC-PD Power Wiring Preparation](#), [Table 5](#), and [Table 6](#) for IAC-PD wiring and termination recommendations.
9. Connect phase A, B, and C, Neutral, and Ground power wiring to the subfeed breaker terminal blocks or output breaker and the critical load.
For a detailed view of the IAC-PD output terminals, see [Figure 18](#).
10. If adjustable subfeed breakers are installed, proceed to paragraph [4.4 Adjustable Subfeed Breakers](#) to adjust current trip settings; otherwise, proceed to [Step 11](#).
11. Reinstall the inside trim plate removed in [Step 3](#).
12. Close the inside door and secure with screws.
13. Close the outside door and secure the latch.
14. After the IAC-PD is installed and wired, return to the applicable Eaton 93PM UPS manual listed in paragraph [1.7 For More Information](#) to complete the UPS wiring.

Figure 16. IAC-PD with Two Panelboards – Terminal Locations

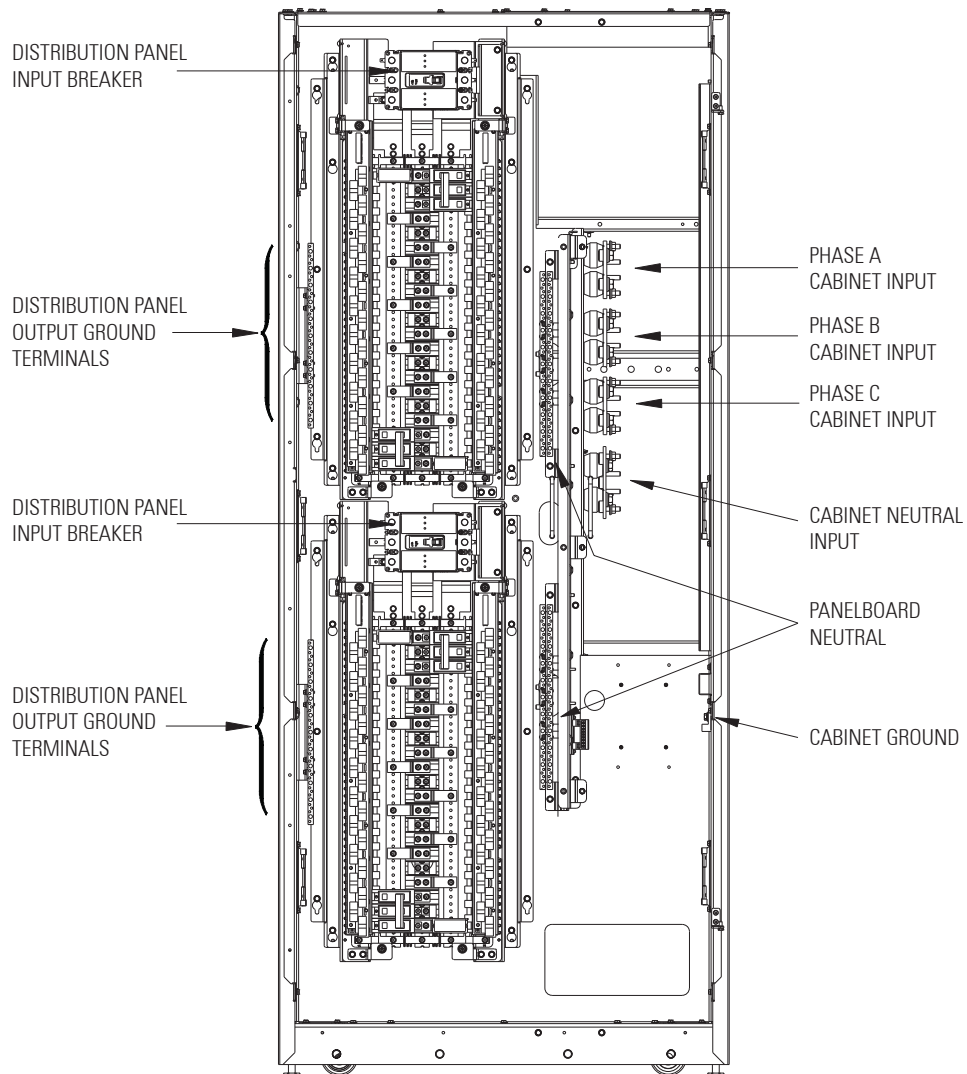

225/400A PANELBOARD (TOP)
225/400A PANELBOARD (BOTTOM)
208 OR 480V 4-WIRE
3-WIRE SAME MINUS NEUTRAL

Figure 17. IAC-PD with Top Subfeed Breaker and Bottom Panelboard – Terminal Locations

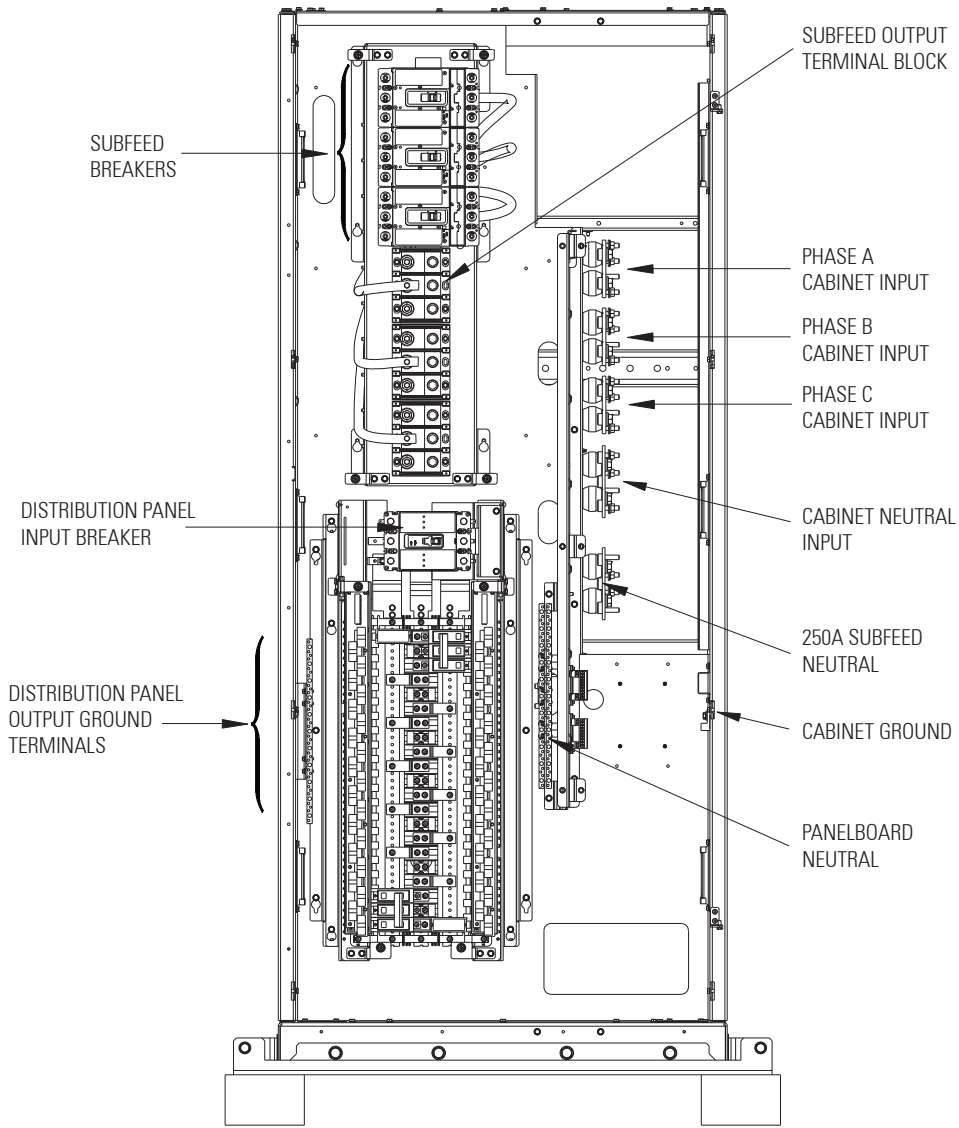

250A SUBFEED (TOP)
PANELBOARD (BOTTOM)
208 OR 480v 4-WIRE
3-WIRE SAME MINUS NEUTRAL

Figure 18. Subfeed Breaker Output Power Terminal Detail

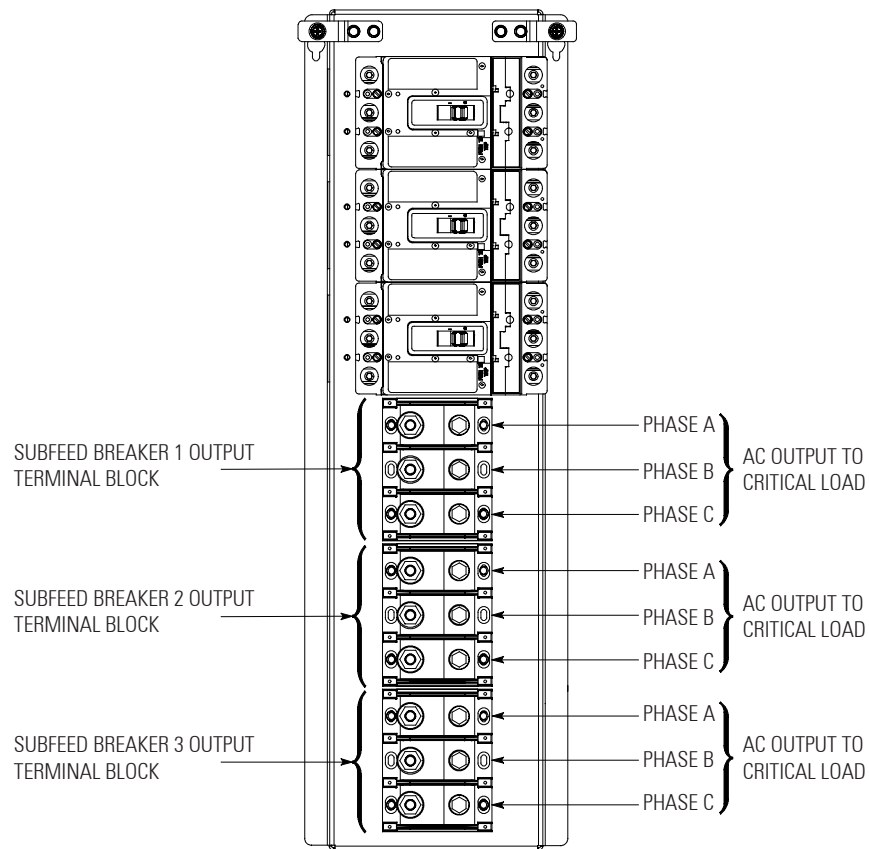
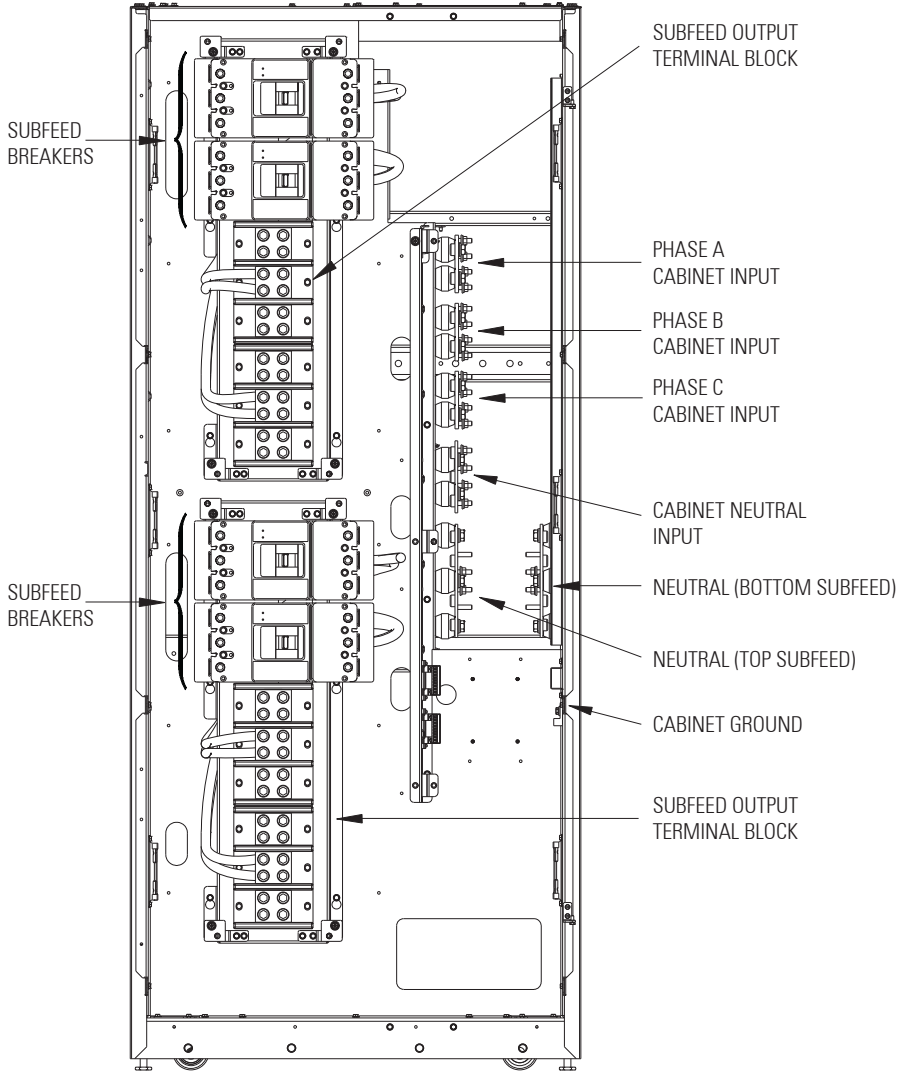

Figure 19. IAC-PD with Top and Bottom Subfeed Breakers – Terminal Locations



400A SUBFEED (TOP)
400A SUBFEED (BOTTOM)
208 OR 480V 4-WIRE
3-WIRE SAME MINUS NEUTRAL

4.4 Adjustable Subfeed Breakers

The subfeed breakers installed in the IAC-PD contain adjustable current trip settings. The continuous current (I_r) values for the corresponding lettered adjustment setting marked on the subfeed breakers are listed in [Table 9](#) and [Table 10](#).

To adjust breaker:

1. If not already open, open the front door by lifting the latch from the bottom and turning to the right (counterclockwise) and swing the door open.
2. Remove the screws securing the breaker trim plate and remove the plate. Retain trim plate and hardware for later use.
3. Using the dial on the subfeed breaker adjust the breaker current rating as required to protect the wiring to the load. See [Table 9](#) and [Table 10](#) for the breaker continuous current adjustment letter.
4. Reinstall the inside trim plate removed in [Step 2](#).
5. Close the outside door and secure the latch.
6. After the IAC-PD is installed and wired, return to the appropriate Eaton 93PM UPS manual listed in paragraph [1.7 For More Information](#) to complete the UPS wiring.

Table 9. JG-Frame 250A Subfeed Breaker Continuous Current (I_r) Settings

Breaker Setting	Continuous Current (I _r)
A	100A
B	125A
C	150A
D	160A
E	175A
F	200A
G	225A
H	250A

Table 10. K-Frame 400A Subfeed Breaker Continuous Current (I_r) Settings

Breaker Setting	Continuous Current (I _r)
A	160A
B	200A
C	225A
D	250A
E	300A
F	315A
G	350A
H	400A

4.5 Initial Startup

Startup and operational checks must be performed by an authorized Eaton Customer Service Engineer, or the warranty terms specified in paragraph [9.1 Warranty](#) become void. This service is offered as part of the sales contract for the UPS. Contact an Eaton service representative in advance (usually a two-week notice is required) to reserve a preferred startup date.

4.5.1 Completing the Installation Checklist

The final step in installing the IAC-PD is completing the following Installation Checklist. This checklist ensures that you have completely installed all hardware, cables, and other equipment. Complete all items listed on the checklist to ensure a smooth installation. Make a copy of the Installation Checklist before filling it out, and retain the original.

After the installation is complete, an Eaton Customer Service Engineer must verify the operation of the UPS system and commission it to support the critical load. The service representative cannot perform any installation tasks other than verifying software and operating setup parameters. Service personnel may request a copy of the completed Installation Checklist to verify all applicable equipment installations have been completed.



NOTE

The Installation Checklist **MUST** be completed prior to starting the UPS system for the first time.

4.5.2 Installation Checklist

- All packing materials and restraints have been removed from each cabinet.
- The IAC-PD is installed on a level floor suitable for computer or electronic equipment.
- The IAC-PD is placed in its installed location.
- The IAC-PD is secured to the building floor or attached to the adjacent 93PM system cabinet with the cabinet bracket.
- All conduits and cables are properly routed between the IAC-PD and the UPS.
- All power cables are properly sized and terminated.
- Distribution panel branch circuit breakers are installed and wired to load.
- A ground conductor is properly installed.
- All terminal cover plates are installed.
- Air conditioning equipment is installed and operating correctly.
- The area around the UPS system is clean and dust-free.
- Adequate workspace exists around the IAC-PD and other cabinets.
- Adequate lighting is provided around all IAC-PD and UPS equipment.
- A 120 Vac service outlet is located within 7.5 meters (25 feet) of the IAC-PD and UPS equipment.
- Startup and operational checks are performed by an authorized Eaton Customer Service Engineer.
- Visit www.eaton.com/pg/register to register the new Eaton UPS/Eaton UPS Accessory.

Chapter 5 Onelines and Schematics

5.1 IAC-PD Onelines and Schematics

5.1.1 Onelines

Figure 20 through Figure 25 show the simplified internal structure of the various Eaton 93PM IAC-PD configurations.

Figure 20. 93PM IAC-PD with Single Panelboard

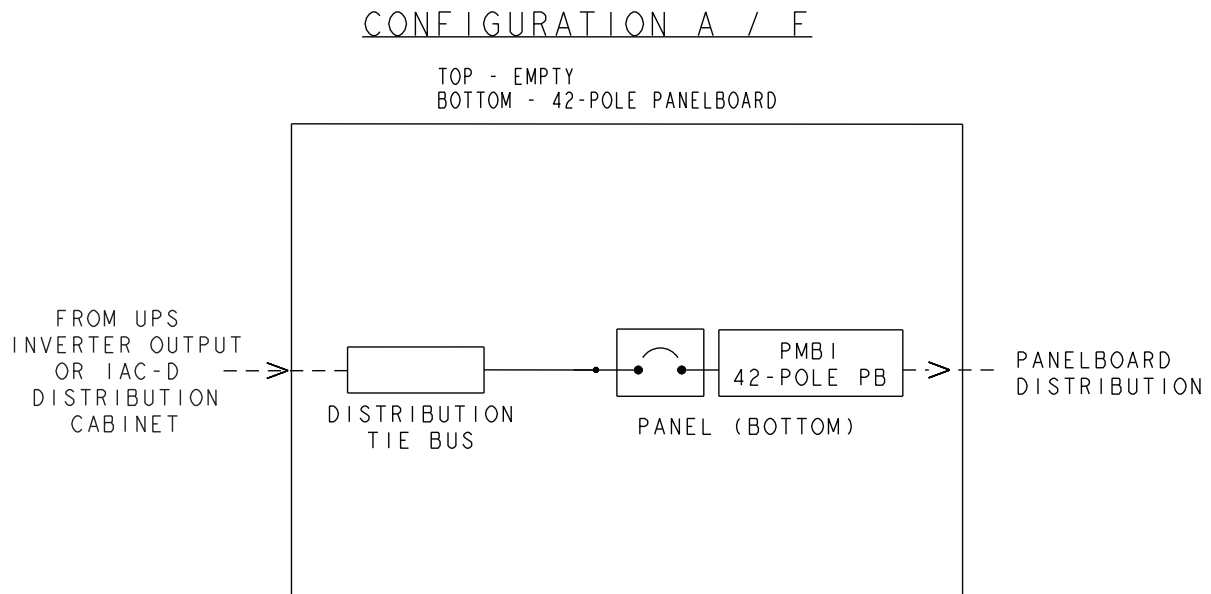

Figure 21. 93PM IAC-PD with Dual Panelboards

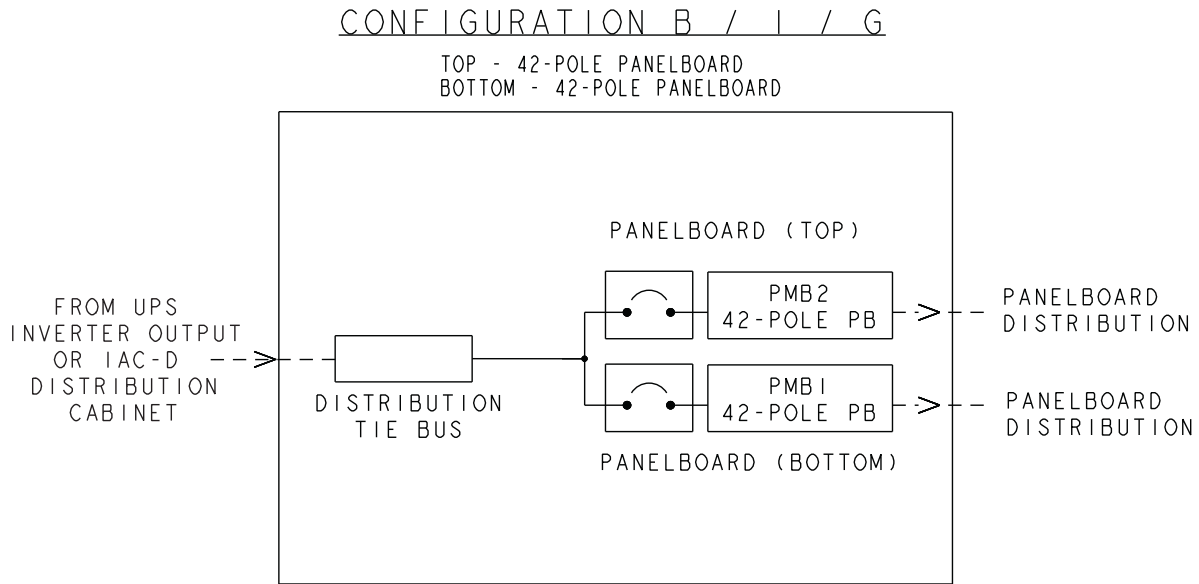

Figure 22. 93PM IAC-PD with One, Two, or Three 250A Subfeed Breakers and a Single Panelboard

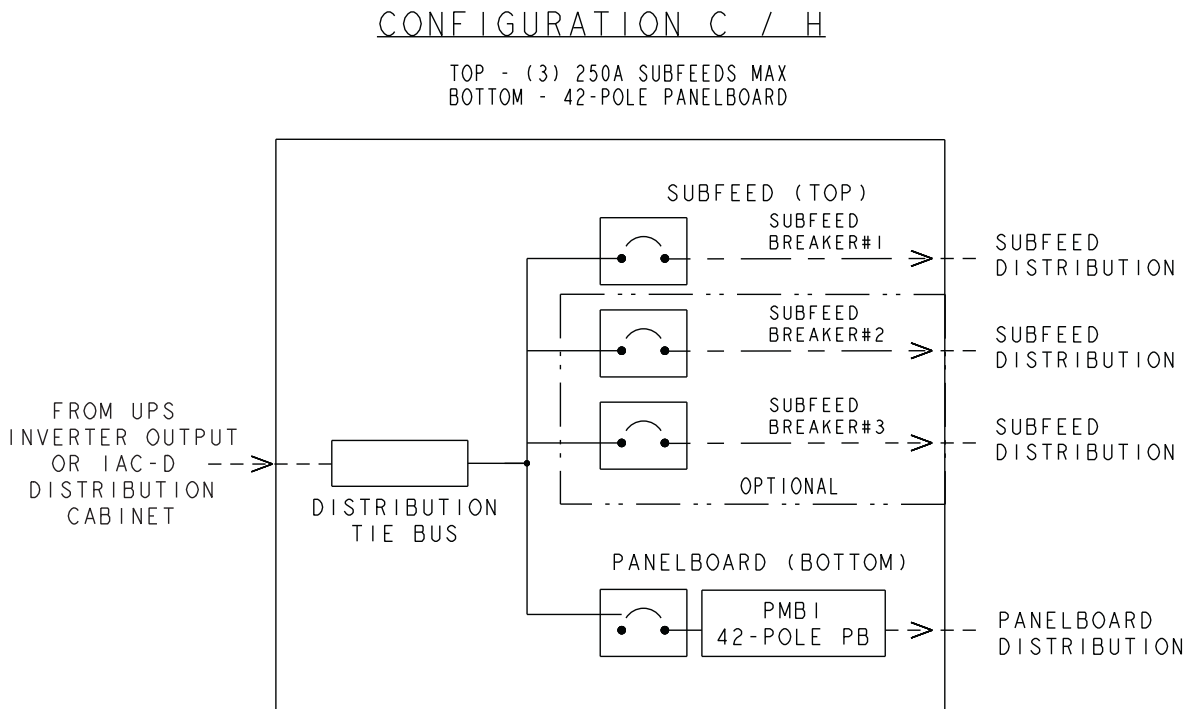

Figure 23. 93PM IAC-PD with One or Two 400A Subfeed Breakers and a Single Panelboard

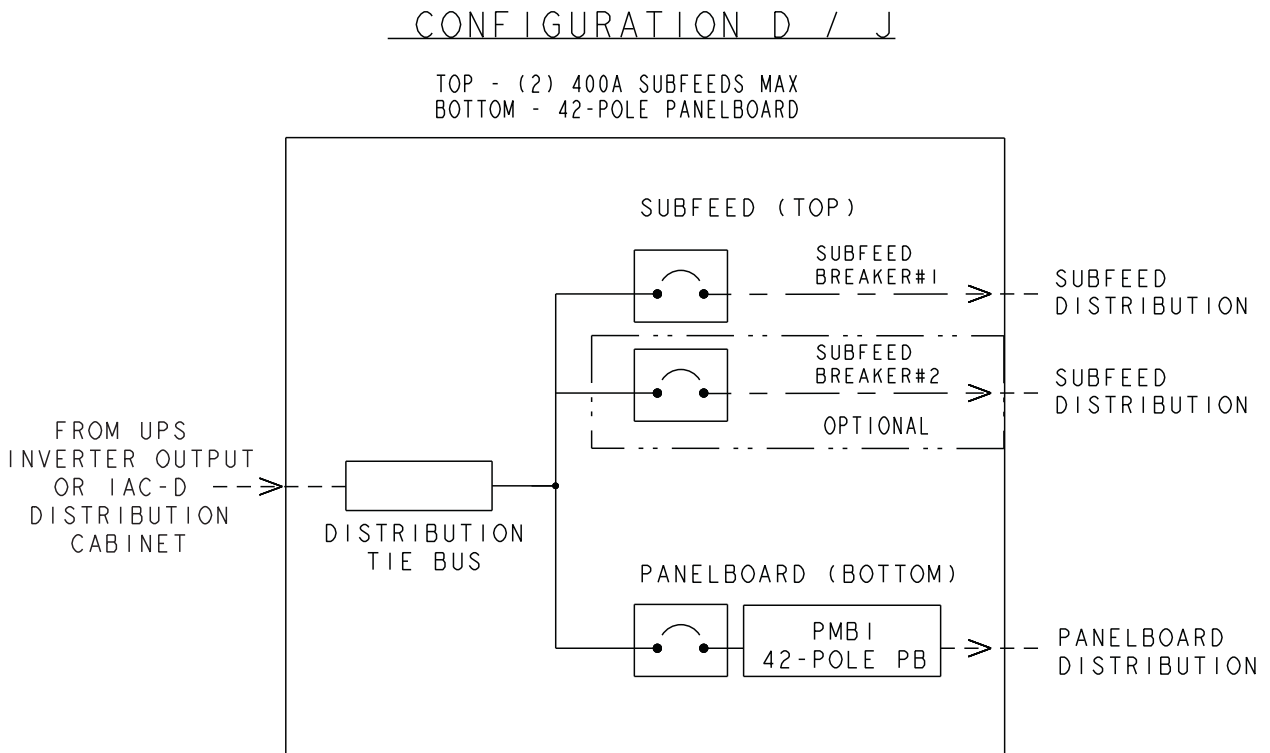

Figure 24. 93PM IAC-PD with Four 400A Subfeed Breakers

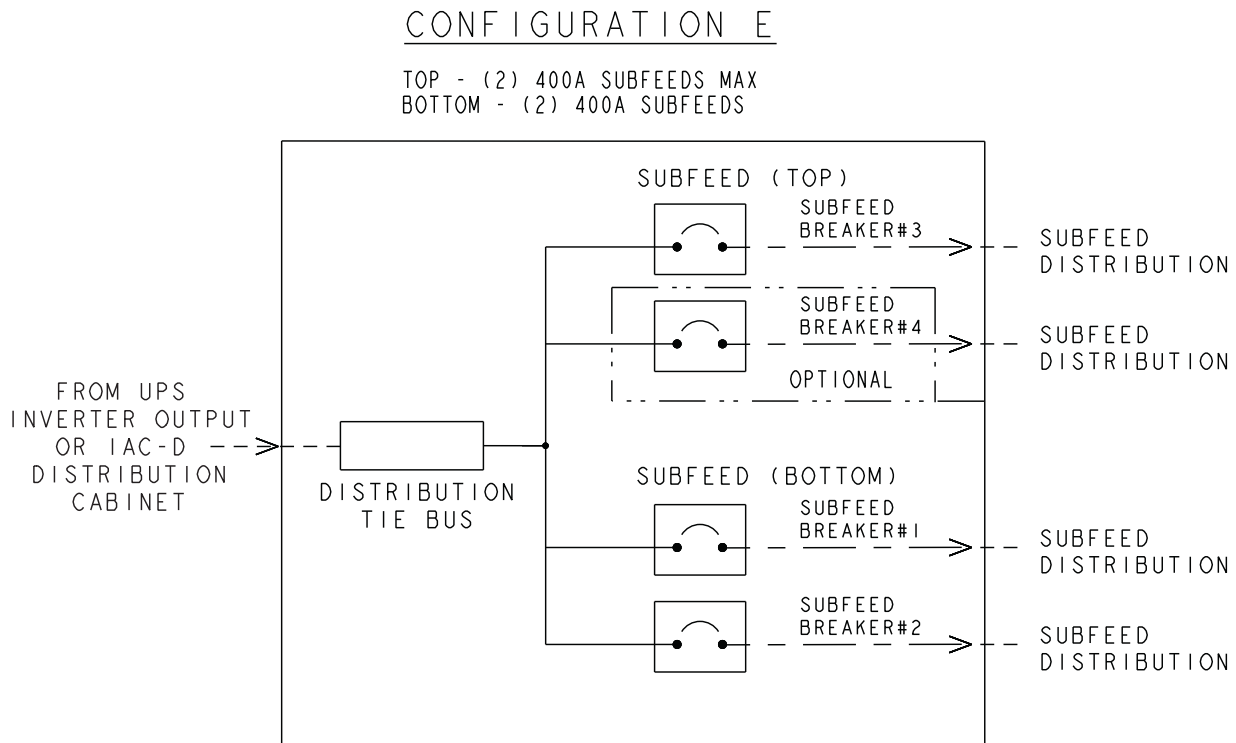
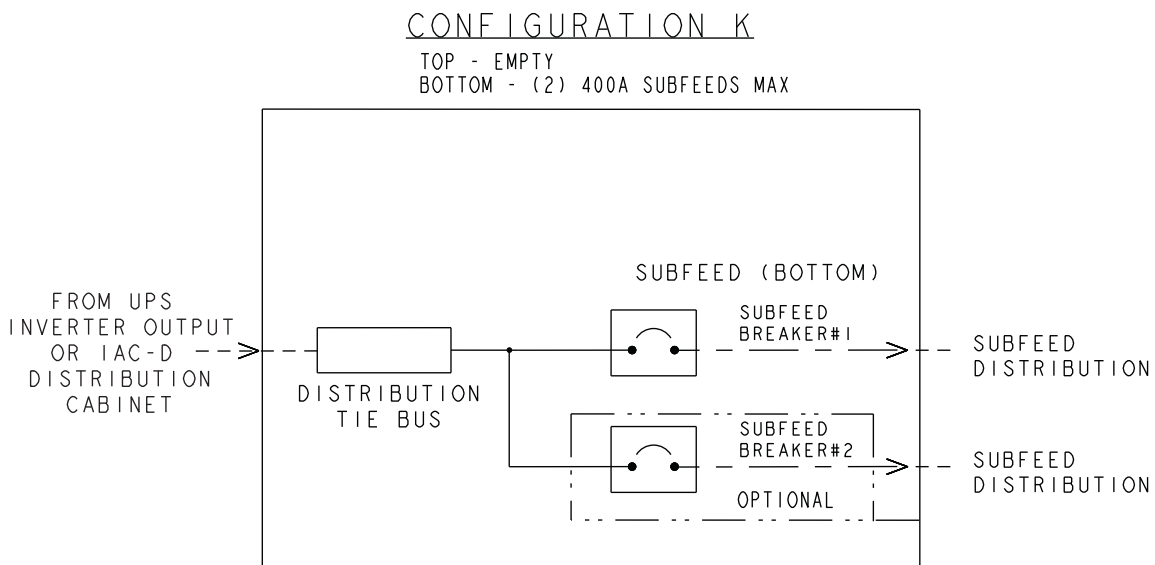

Figure 25. 93PM IAC-PD with Two 400A Subfeed Breakers



5.1.2 Schematics

[Figure 26](#) through [Figure 30](#) show the schematics for the various 93PM IAC-PD configurations.

Figure 26. 93PM IAC-PD Configuration A and F Schematic

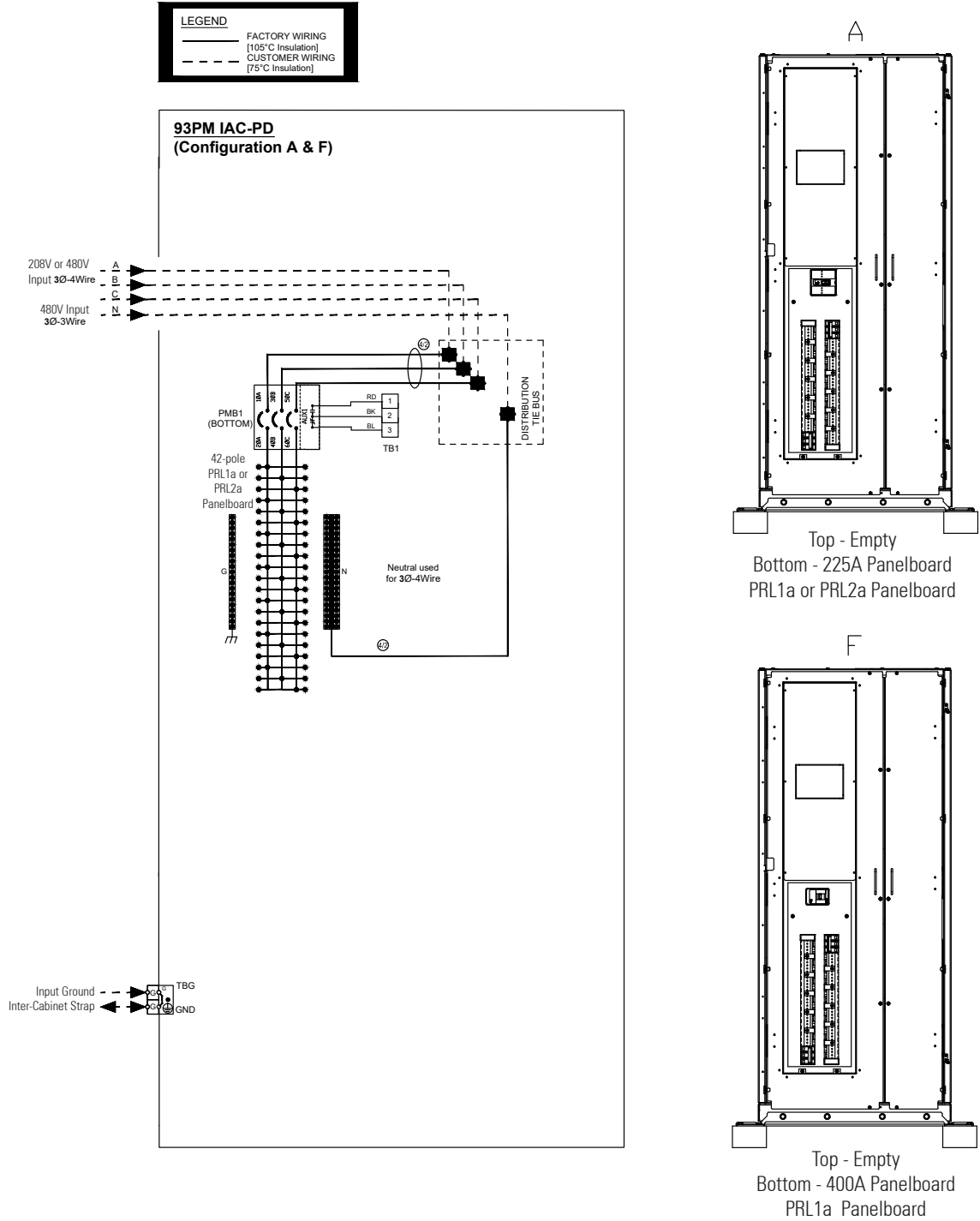

Figure 27. 93PM IAC-PD Configuration B, G, and I Schematic

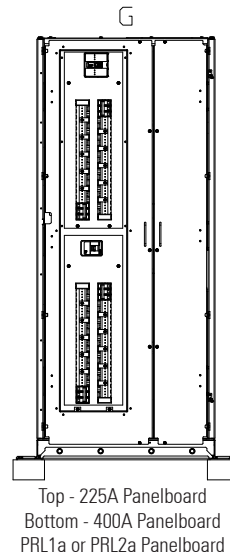
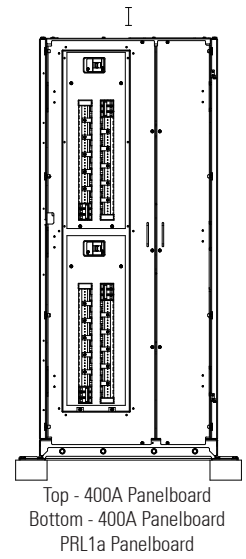
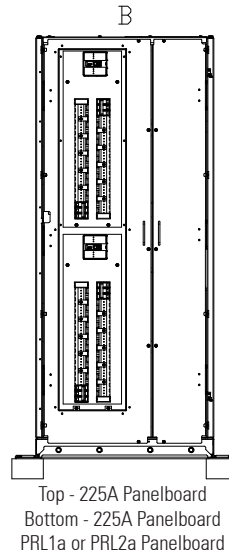
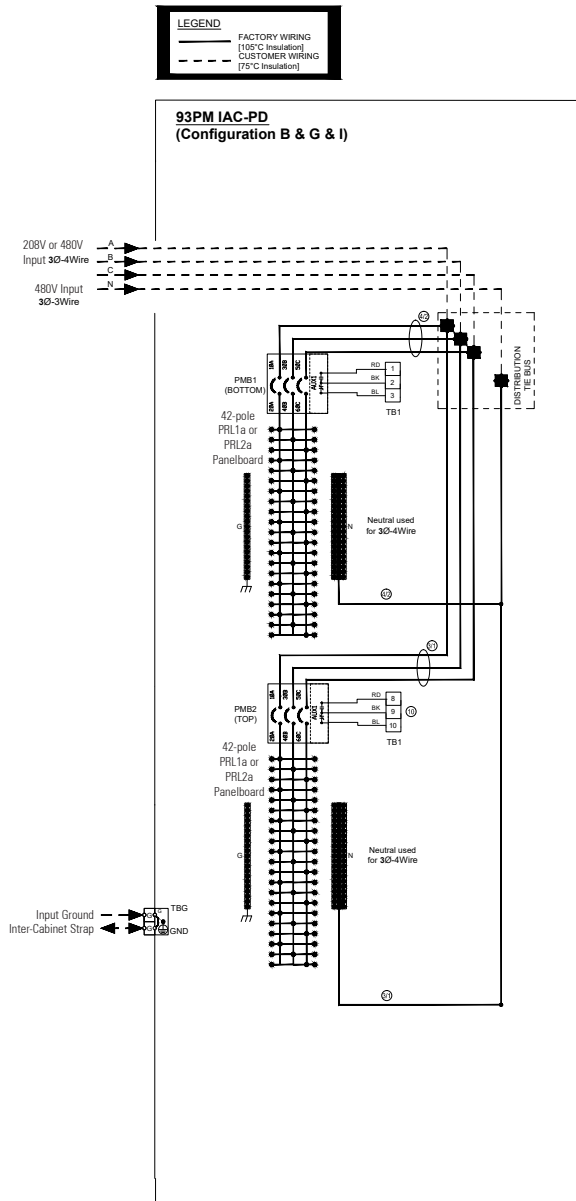

Figure 28. 93PM IAC-PD Configuration C and H Schematic

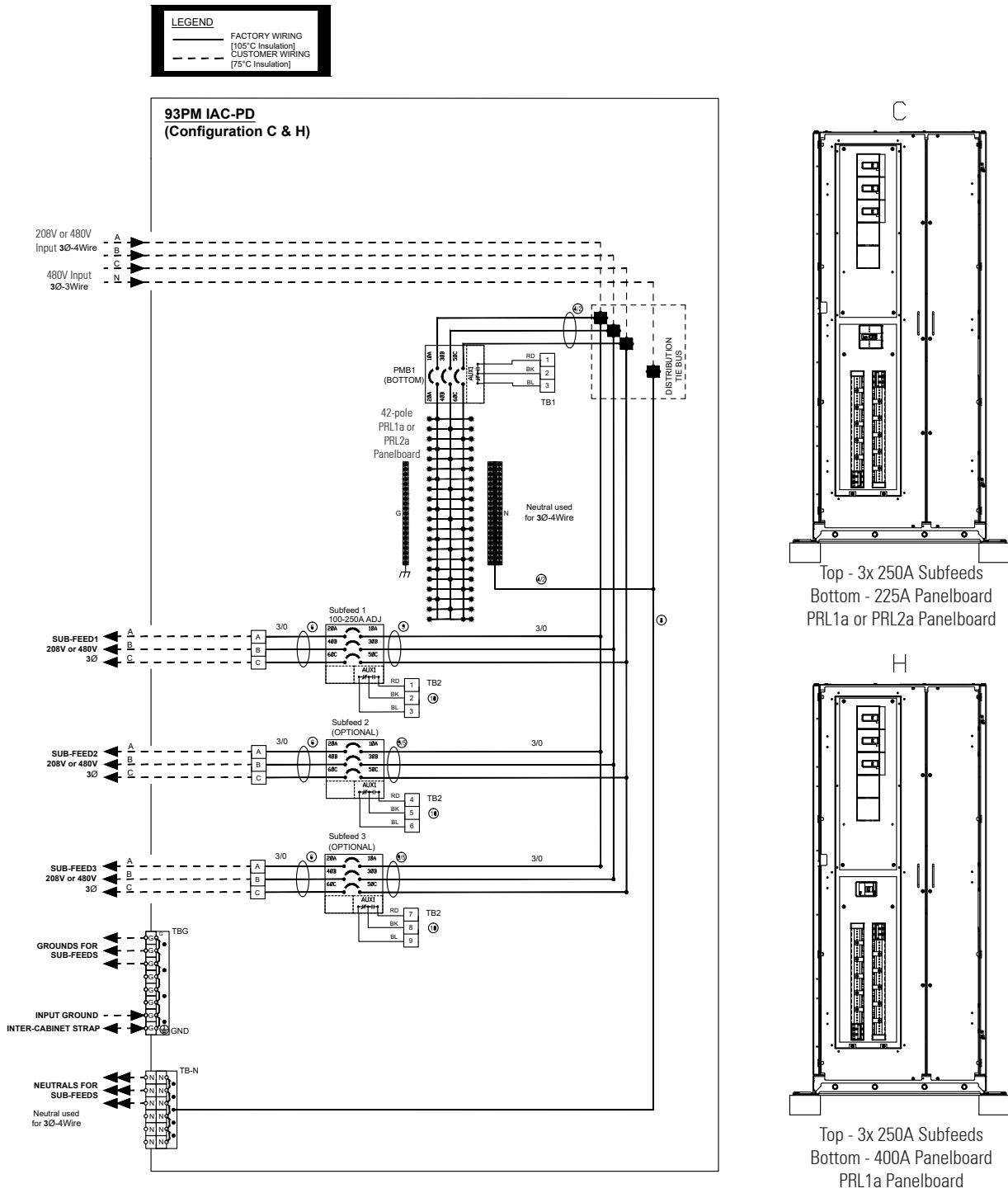

Figure 29. 93PM IAC-PD Configuration D and J Schematic

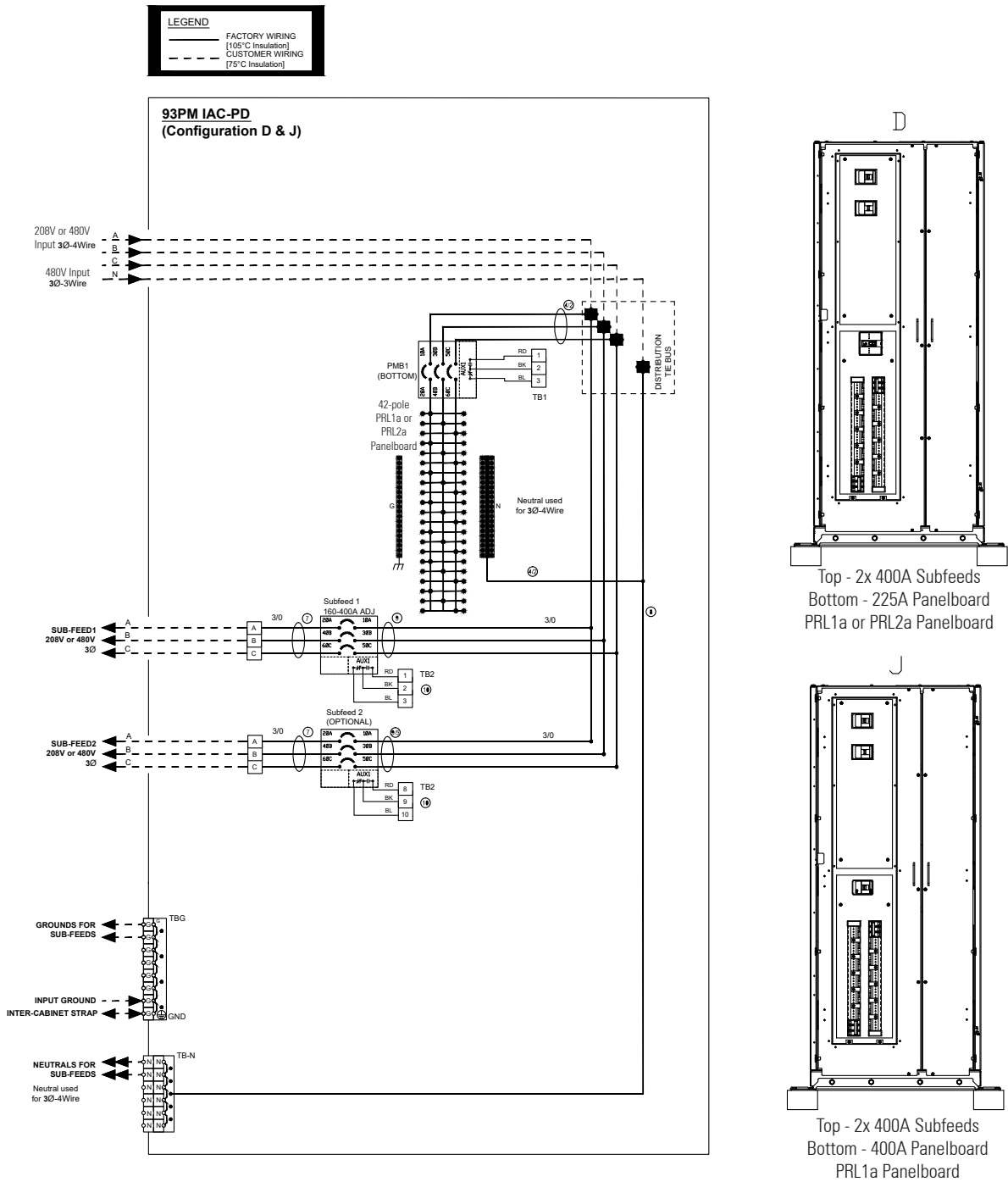
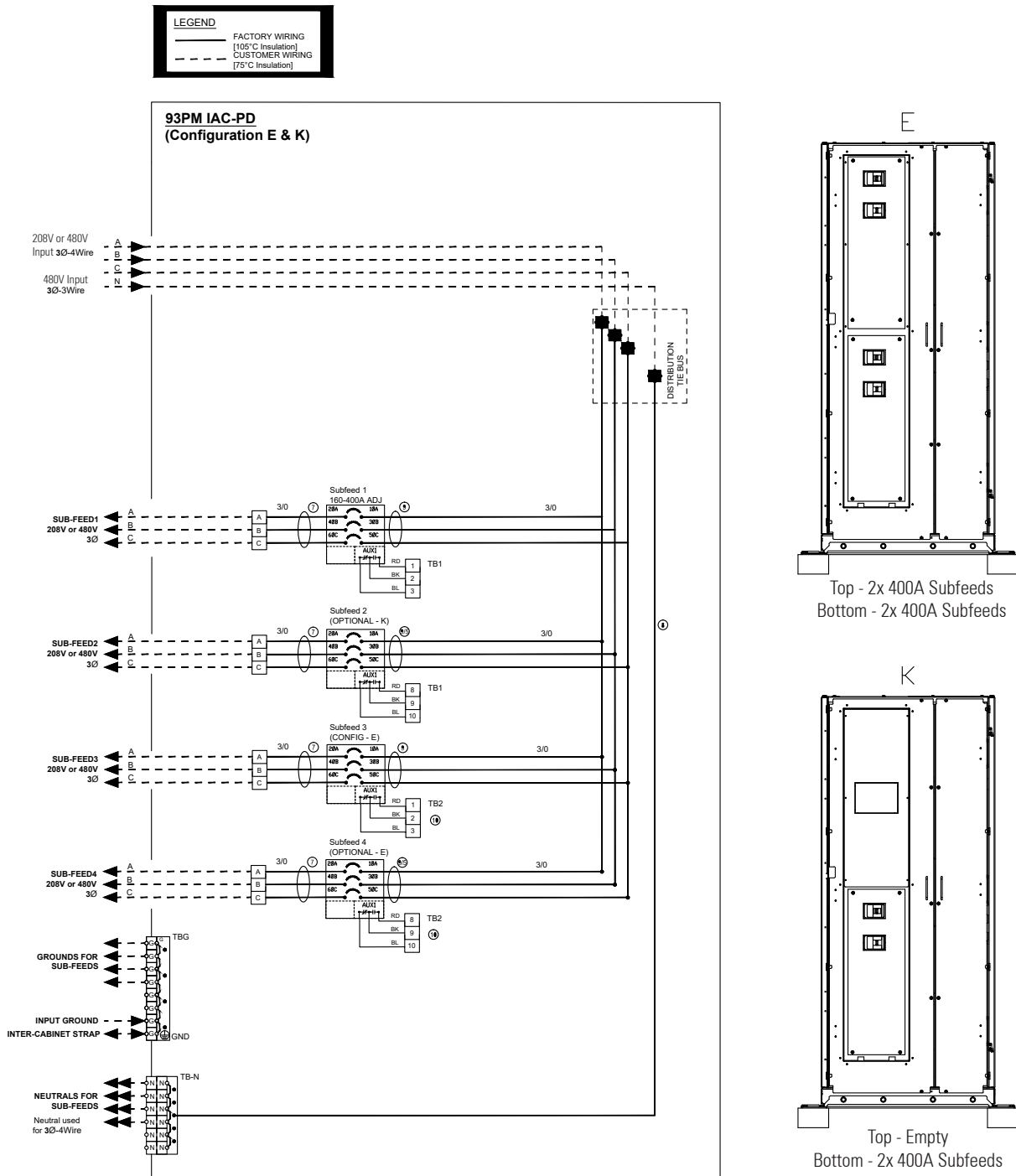

Figure 30. 93PM IAC-PD Configuration E and K Schematic



Chapter 6 Operation

6.1 Integrated Accessory Cabinet-Power Distribution Operating Instructions

This section describes how to operate the Integrated Accessory Cabinet-Power Distribution (IAC-PD).



NOTE 1 Before using the IAC-PD, ensure all installation tasks are complete and a preliminary startup has been performed by authorized service personnel. The preliminary startup verifies all electrical interconnections to ensure the installation was successful and the system operates properly.

NOTE 2 Read this section of the manual and have thorough knowledge of IAC-PD operation before attempting to operate any of the controls.

6.1.1 IAC-PD Breakers

[Figure 31](#) through [Figure 33](#) identify and show the location of the breakers on the IAC-PD.

The IAC-PDs can contain the following breakers:

- **Distribution Panel Input Breaker** – Controls input to the distribution panel
- **Distribution Panel Branch Breakers** – Provides up to 42 branch circuits per panel to distribute the output power to the loads
- **Subfeed Breakers** – Up to four optional subfeed breakers for high current loads

6.1.2 IAC-PD Operation

To operate the IAC-PD:

1. Open the front door by lifting the latch from the bottom and turning to the right (counterclockwise) and swing the door open.
2. Verify that the IAC-PD circuit breakers are set as follows:

Breaker	Switch Position
Distribution Panel Input Breaker	OPEN
Distribution Panel Branch Breakers	OPEN
Subfeed Breakers (if installed)	OPEN

3. Start the UPS. Refer to the applicable Eaton 93PM UPS manual listed in paragraph [1.7 For More Information](#) for UPS operating procedures.
4. Close the distribution panel input breaker.
5. Close the distribution panel branch breakers
6. Close the subfeed breakers (if installed).
7. Close the door and secure the latch.

Figure 31. 93PM IAC-PD Breakers – Two Panelboards

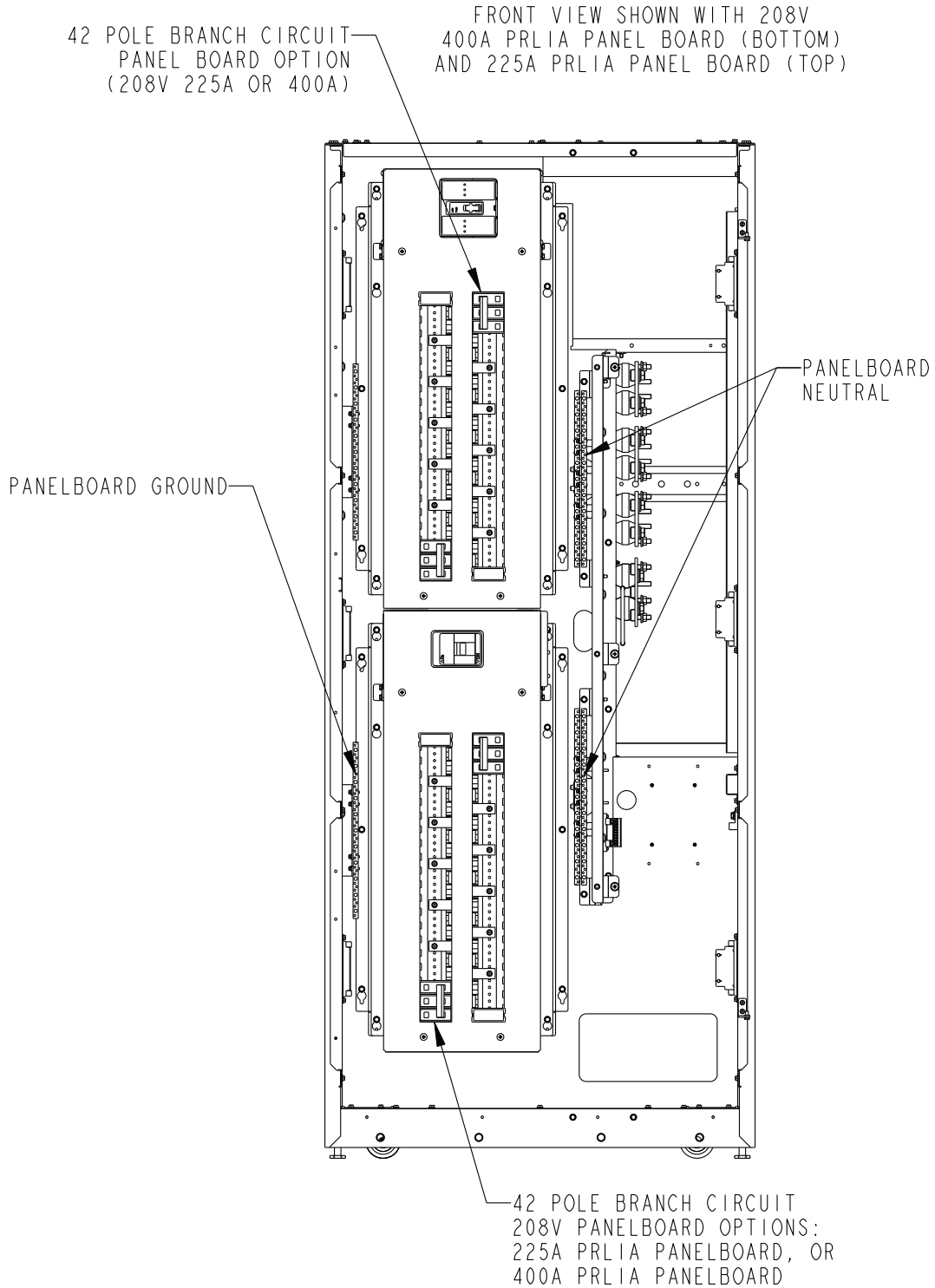

Figure 32. 93PM IAC-PD Breakers – Top Subfeed Breakers with Bottom Panelboard

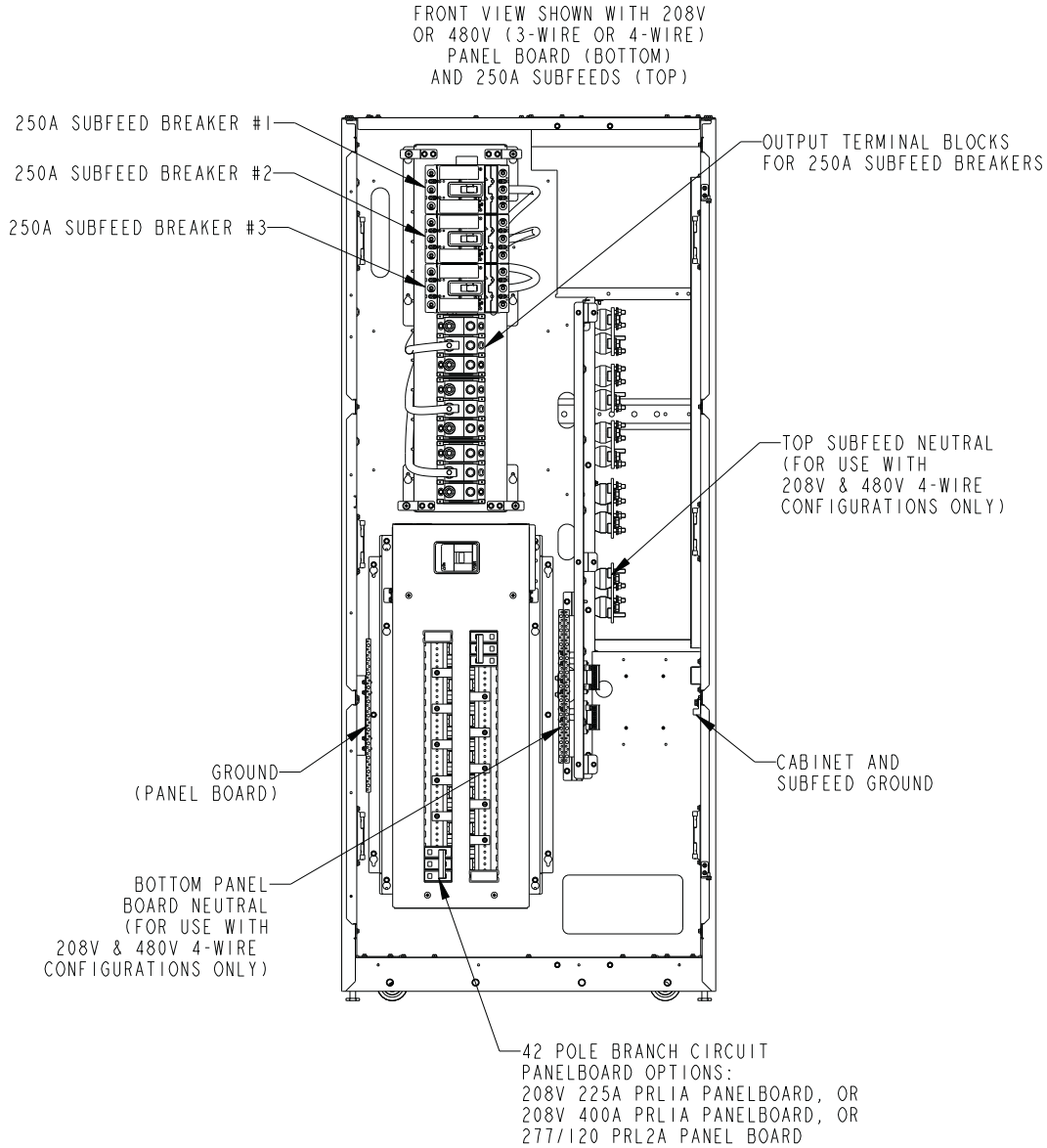
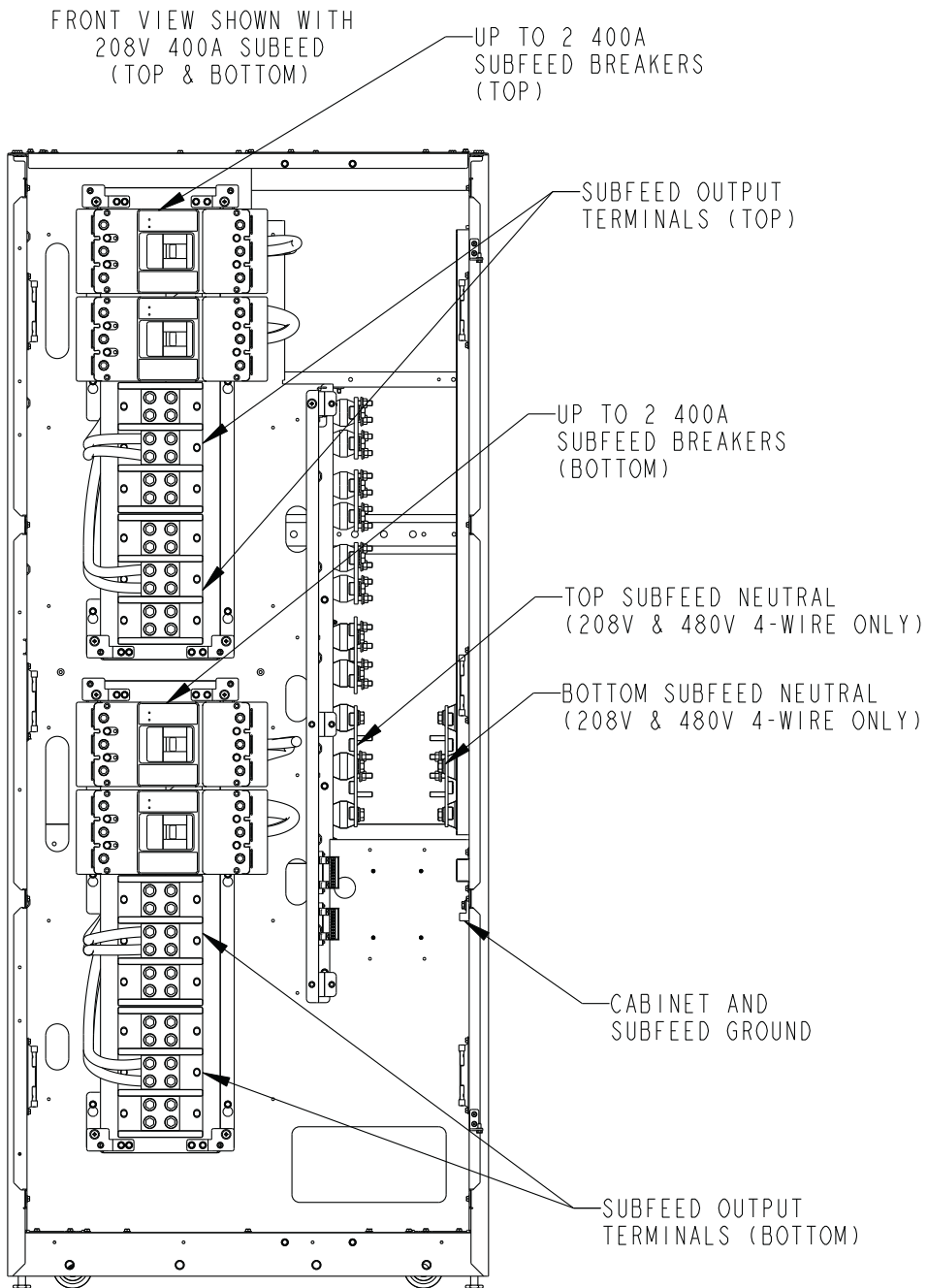

Figure 33. 93PM IAC-PD Breakers – Subfeed Breakers



Chapter 7 Maintenance

7.1 Maintenance

The components inside the IAC-D are secured to a sturdy metal frame. All repairable parts and assemblies are located for easy removal, with very little disassembly. This design allows authorized service personnel to quickly perform routine maintenance and servicing.

You must schedule periodic performance checks of the UPS system to keep it running properly. Regular routine checks of operation and system parameters enable your system to function efficiently for many trouble-free years.

7.1.1 Important Safety Instructions

Remember that your UPS system is designed to supply power **EVEN WHEN DISCONNECTED FROM THE UTILITY POWER.**



- No user serviceable components.
 - Servicing and maintenance should be performed by qualified service personnel only.
 - LETHAL VOLTAGE PRESENT. This unit should not be operated with the cabinet doors open or protective panels removed. Do not make any assumptions about the electrical state of any cabinet in the UPS system.
-

7.2 Performing Preventive Maintenance

The UPS system requires very little preventive maintenance. However, the system should be inspected periodically to verify that the units are operating normally. Record maintenance results and any corrective actions in a suitable log.

7.2.1 DAILY Maintenance

Perform the following steps daily:

1. Check the area surrounding the UPS system. Ensure the area is not cluttered, allowing free access to the unit.
2. Ensure the air intakes on the accessory cabinets are not blocked.
3. Ensure the operating environment is within the parameters specified in paragraph [3.2.1 Environmental and Installation Considerations](#) and Chapter [8.1](#), "Product Specifications."

7.2.2 PERIODIC Maintenance

Periodic inspections of the IAC-D should be made to determine if components, wiring, and connections exhibit evidence of overheating. Particular attention should be given to the compression lug connections. Maintenance procedures should specify that the compression lug connections be retorqued to values listed in this manual.

7.2.3 ANNUAL Maintenance

Annual preventive maintenance should be performed only by authorized service personnel familiar with maintenance and servicing of the UPS system. Contact an Eaton service representative for more information about service offerings.

7.3 Maintenance Training

A basic training course, available from Eaton Corporation, gives you a competent working knowledge of the UPS system operation and teaches you how to perform first level corrective maintenance. For more information about training and other services, contact the Help Desk (see paragraph [1.8 Getting Help](#)).

Chapter 8 Product Specifications

8.1 Product Specifications

This section provides the following specifications:

- Models
- Input specifications
- Output specifications
- Environmental and safety specifications

8.1.1 Models

The Integrated Accessory Cabinet-Power Distribution (IAC-PD) is available in various model configurations to meet the needs of the Eaton 93PM UPS product line.

Integrated Accessory Cabinet-Power Distribution (IAC-PD) Models

Eaton 93PM IAC-PD with (1) 400A Panelboard (Bottom) (Top Empty)

Eaton 93PM IAC-PD with (2) 400A Panelboards

Eaton 93PM IAC-PD with (1) 400A Panelboard and (1) 400A Subfeed Breaker

Eaton 93PM IAC-PD with (1) 400A Panelboard and (2) 400A Subfeed Breakers

Eaton 93PM IAC-PD with (1) 400A Panelboard and (1) 250A Subfeed Breaker

Eaton 93PM IAC-PD with (1) 400A Panelboard and (2) 250A Subfeed Breakers

Eaton 93PM IAC-PD with (1) 400A Panelboard and (3) 250A Subfeed Breakers

Eaton 93PM IAC-PD with (2) 400A Subfeed Breakers (2-Breakers each)

Eaton 93PM IAC-PD with (1) 400A Subfeed Breaker (2-Breaker), Top Empty

8.1.2 Specifications

The following sections detail the input, output, and environmental and safety specifications for the IAC-PD.

8.1.2.1 Input

Operating Input Voltage Range	208V nominal (60 Hz) or 480V nominal (60 Hz)
Input Wiring:	208 Vac: 4-Wire + Ground 480 Vac: 3-Wire + Ground or 4-Wire + Ground
Operating Input Frequency Range	60 Hz \pm 5 Hz
Operating Input Current	See Table 5

8.1.2.2 Output

Operating Output Voltage	120/208V, 480V 3W, or 480V 4W Vac nominal
Output Wiring:	208 Vac: 4-Wire + Ground
	480 Vac: 3-Wire + Ground or 4-Wire + Ground
Operating Output Frequency Range	60 Hz ± 5 Hz
Output Current	See Table 6

8.1.2.3 Environmental and Safety Specifications

Operating Temperature	41°F to 104°F (5°C to 40°C).
Transit Temperature	-13°F to 140°F (-25°C to 60°C)
Storage Temperature	-13°F to 131°F (-25°C to 55°C)
Operating Altitude	Maximum 1500m (5000 ft) at 40°C without derating
Transit Altitude	15000m (49213 ft)
Ventilation	Convection air cooling for rear venting Convection air cooling for top venting
Relative Humidity (operating and storage)	5 to 95%, noncondensing
Acoustical Noise	Not applicable
Safety Conformance	UL1778 5 th edition
Agency Markings	cULus
EMC (Class A)	FCC Part 15 Class A and 62040-2 c3

Chapter 9 Warranty

9.1 Warranty

Limited FACTORY WARRANTY for Three-Phase Eaton 93PM UPS and 93PM UPS Accessory Products

WARRANTOR: The warrantor for the limited warranties set forth herein is Eaton ("Eaton").

LIMITED WARRANTY: This limited warranty (this "Warranty") applies only to the original end-user (the "End-User") of the Eaton Three-Phase 93PM UPS and 93PM UPS Accessory Products (the "Product") and cannot be transferred. This restriction applies even in the event that the Product is initially sold by Eaton for resale to an End-User. This Warranty gives you specific legal rights, and you may also have other rights which vary from State to State (or jurisdiction to jurisdiction).

WHAT THIS LIMITED WARRANTY COVERS: The warrantor warrants, with the terms of this Warranty, that the Eaton three-phase UPS electronics, Eaton-built accessories, and Eaton-built battery cabinets (individually and collectively, the "Warranted Items") are free from defects in material and workmanship.

For Product installed (and currently located) in the fifty (50) United States and the District of Columbia, if, in the opinion of Eaton, a Warranted Item is defective, Eaton's sole obligation, at the option of Eaton, will be to refurbish or replace such defective Warranted Item (including the costs of providing diagnosis, service, and labor ["labor coverage"]). The defective Warranted Item will be refurbished or replaced onsite at the End-User's location or such other location as determined by Eaton. Any parts that are replaced may be new or reconditioned. All parts replaced by Eaton shall become the property of Eaton.

For Product installed (and currently located) outside the fifty (50) United States and the District of Columbia, if, in the opinion of Eaton, a Warranted Item is defective, Eaton's sole obligation, at the option of Eaton, will be to refurbish or replace such defective Warranted Item (not including the costs of labor coverage). The defective Warranted Item will be refurbished or replaced onsite at the End-User's location or such other location as determined by Eaton. Any parts that are replaced may be new or reconditioned. All parts replaced by Eaton shall become the property of Eaton.

LIMITED WARRANTY PERIOD: The period covered by this Warranty for Product installed (and currently located) in the fifty (50) United States and the District of Columbia is six (6) months from the date of Product purchase for labor coverage when no startup is performed by an authorized Eaton Customer Service Engineer or Agent or twelve (12) months from the date of Product purchase with startup performed by an authorized Eaton Customer Service Engineer or Agent and twelve (12) months from the date of Product purchase or eighteen (18) months from date of Product shipment, whichever occurs first, for the refurbishment/replacement of parts.

The period covered by this Warranty for Product installed (and currently located) outside the fifty (50) United States and the District of Columbia is twelve (12) months from the date of Product purchase or eighteen (18) months from the date of Product shipment, whichever occurs first, for the refurbishment/replacement of parts.

WHAT THIS LIMITED WARRANTY DOES NOT COVER: This Warranty does not cover any defects or damages caused by: (a) failure to properly store the Product before installation, including the "trickle charge" of batteries no later than the date indicated on the packaging; (b) shipping and delivery of the Product if shipping is FOB Factory; (c) neglect, accident, fire, flood, lightning, vandalism, acts of God, Customer's neglect, abuse, misuse, misapplication, incorrect installation; (d) repair or alteration not authorized in writing by Eaton personnel or performed by an authorized Eaton Customer Service Engineer or Agent; or (e) improper testing, operation, maintenance, adjustment, or any modification of any kind not authorized in writing by Eaton personnel or performed by an authorized Eaton Customer Service Engineer or Agent.

This Warranty is not valid: if the Product's serial numbers have been removed or are illegible. Any Warranted Items repaired or replaced pursuant to this Warranty will be warranted for the remaining portion of the original Warranty subject to all the terms thereof. Eaton does not provide a labor warranty for Product located outside of the fifty (50) United States or the District of Columbia. **Any equipment, parts, or materials included in the**

Product and not manufactured by Eaton are warranted solely by the manufacturer of such equipment, parts, or materials and are not included as part of this Warranty. Batteries are not warranted by Eaton.

THIS WARRANTY IS THE END-USER'S SOLE REMEDY AND IS EXPRESSLY IN LIEU OF, AND THERE ARE NO OTHER, EXPRESSED OR IMPLIED GUARANTEES OR WARRANTIES (INCLUDING ANY IMPLIED WARRANTY OF MERCHANTABILITY OR FITNESS FOR ANY PURPOSE, WHICH ARE EXPRESSLY DISCLAIMED). SOME STATES OR JURISDICTIONS DO NOT ALLOW THE EXCLUSION OF EXPRESS OR IMPLIED WARRANTIES, SO THE ABOVE EXCLUSION MAY NOT APPLY TO YOU. IN THAT EVENT, SUCH WARRANTIES ARE LIMITED IN DURATION TO THE LIMITED WARRANTY PERIOD. SOME STATES OR JURISDICTIONS DO NOT ALLOW LIMITATIONS ON HOW LONG AN IMPLIED WARRANTY LASTS OR THE EXCLUSION OR LIMITATION OF INCIDENTAL OR CONSEQUENTIAL DAMAGES, SO THE ABOVE LIMITATIONS AND/OR EXCLUSIONS MAY NOT APPLY TO YOU.

LIMITATION OF LIABILITY: In no event shall Eaton be liable for any indirect, incidental, special or consequential damages of any kind or type whatsoever, resulting from or in connection with any claim or cause of action, whether brought in contract or in tort (including negligence and strict liability). Some States or jurisdictions do not allow the exclusion of limitation of incidental or consequential damages, so the above limitation or exclusion may not apply to you. Eaton shall not be responsible for failure to provide service or parts due to causes beyond Eaton's reasonable control. In no case will Eaton's liability under this Warranty exceed the replacement value of the Warranted Items.

END-USER'S OBLIGATIONS: In order to receive the benefits of this Warranty, the End-User must register the product warranty (via mail or online at www.eaton.com/pg/register "product registration"); use the Product in a normal way; follow the Product's user's guide; and protect against further damage to the Product if there is a covered defect.

OTHER LIMITATIONS: Eaton's obligations under this Warranty are expressly conditioned upon receipt by Eaton of all payments due to it (including interest charges, if any). During such time as Eaton has not received payment of any amount due to it for the Product, in accordance with the contract terms under which the Product is sold, Eaton shall have no obligation under this Warranty. Also during such time, the period of this Warranty shall continue to run and the expiration of this Warranty shall not be extended upon payment of any overdue or unpaid amounts.

COSTS NOT RELATED TO WARRANTY: The End-User shall be invoiced for, and shall pay for, all services not expressly provided for by the terms of this Warranty, including without limitation site calls involving an inspection that determines no corrective maintenance is required. Any costs for replacement equipment, installation, materials, freight charges, travel expenses, or labor of Eaton representatives outside the terms of this Warranty will be borne by the End-User.

OBTAINING WARRANTY SERVICE: In the USA, call the Eaton Customer Reliability Center 7x24 at 800-843-9433. Outside of the USA, call your local Eaton sales or service representative, or call the Eaton Customer Reliability Center in the United States at 919845-3633. For comments or questions about this Limited Factory Warranty, write to the Customer Quality Representative, 8609 Six Forks Road, Raleigh, North Carolina 27615 USA.



P-164000694 02