

Eaton® 93PM UPS

480V Three-Wire – 150 kW Frame Installation and Operation Manual



p/n: 164000388
Revision 08

IMPORTANT SAFETY INSTRUCTIONS - SAVE THESE INSTRUCTIONS

This manual contains important instructions that you should follow during installation and maintenance of the UPS and batteries. Please read all instructions before operating the equipment and save this manual for future reference.

CONSIGNES DE SÉCURITÉ IMPORTANTES – CONSERVER CES INSTRUCTIONS

Ce manuel comporte des instructions importantes que vous êtes invité à suivre lors de toute procédure d'installation et de maintenance des batteries et de l'onduleur. Veuillez consulter entièrement ces instructions avant de faire fonctionner l'équipement et conserver ce manuel afin de pouvoir vous y reporter ultérieurement.



IMPORTANT

To ensure you have the most up-to-date content and information for this product, please review the latest manual revision on our website, www.eaton.com/93PM.

Eaton reserves the right to change specifications without prior notice. Modbus is a registered trademark of Schneider Automation, Inc. MOXA is a registered trademark and MGate is a trademark of MOXA, Inc. Spiralock is a registered trademark of Spiralock Corporation. KIRK is a registered trademark of Kirk Key Interlock company, LLC, a subsidiary of Halma plc. National Electrical Code and NEC are registered trademarks of National Fire Protection Association, Inc. ERIFLEX and FLEXIBAR are registered trademark of Erico International Corporation. All other trademarks are property of their respective companies.

©Copyright 2014-2021 Eaton, Raleigh, NC, USA. All rights reserved. No part of this document may be reproduced in any way without the express written approval of Eaton.

EATON END-USER LICENSE AGREEMENT

IMPORTANT, READ CAREFULLY. THIS END USER LICENSE AGREEMENT (THE "AGREEMENT") IS A BINDING CONTRACT BETWEEN YOU, THE END-USER (THE "LICENSEE") AND EATON INTELLIGENT POWER LIMITED, IRELAND, OR ONE OF ITS AFFILIATES ("EATON" OR "LICENSOR"), BY OPERATING THIS UNINTERRUPTIBLE POWER SUPPLY (UPS) PRODUCT INCLUDING SOFTWARE EMBEDDED IN IT (FIRMWARE), YOU, THE LICENSEE, ARE AGREEING TO BE BOUND BY THE TERMS, CONDITIONS, AND LIMITATIONS OF THIS AGREEMENT. READ THE TERMS AND CONDITIONS OF THIS AGREEMENT CAREFULLY BEFORE, INSTALLING OR OPERATING THE PRODUCT. IF YOU DO NOT AGREE TO THE TERMS OF THIS AGREEMENT, PROMPTLY RETURN THE UNUSED PRODUCT TO EATON.

1.0 DEFINITIONS

1.1 Documentation. "Documentation" means the user guides and manuals for the installation and use of the UPS, whether made available over the internet, provided in CD-ROM, DVD, hard copy or other form.

1.2 Firmware. "Firmware" means software programs that are embedded in the product for which Licensee is granted a license hereunder, the Documentation therefore and, to the extent available, Updates thereto. The Firmware is licensed hereunder in object code (machine-readable) form only except that certain software programs may include limited portions in source code (human-readable) form.

1.3 Update. "Update" means a subsequent release of the Firmware, if and when developed by Eaton. An Update does not include any release, new version, option, or future product, which Eaton licenses separately.

2.0 FIRMWARE LICENSE

2.1 Ownership. Eaton or its third party licensors retains all title, copyright and other proprietary rights in, and ownership of the Firmware regardless of the media upon which the original or any copy may be recorded or fixed.

2.2 License Grant. Eaton grants to Licensee a limited, revocable, non-exclusive, non-assignable license to use the Firmware in conjunction with the operation of the product to which the Firmware pertains or other products as described by Eaton in the Documentation. Licensee does not acquire any rights, express or implied, other than those expressly granted in this Agreement.

2.3 Restrictions and Requirements. Licensee will not, nor will it permit others to, modify, adapt, translate, reverse engineer, decompile, or disassemble the Firmware or any component thereof (including the Documentation), or create derivative works based on the Firmware (including the Documentation), except to the extent such foregoing restriction is prohibited by applicable law or applicable open source license to, and only to, any open source software component that is incorporated into the Firmware (if any). Copyright laws and international treaties protect the Firmware, including the Documentation. Unauthorized copying of the Firmware, the Documentation or any part thereof, is expressly prohibited. For avoidance of doubt, Eaton does not grant Licensee a license to any of Eaton's brands, logos, designs, trade dress, service marks, trademarks, domain names or trade names, in whole or in part. Licensee agrees to install or allow installation of all corrections of substantial defects, security patches, minor bug fixes and updates, including any enhancements, for the Firmware in accordance with the instructions and as directed by Eaton.

2.4 Transfer and Assignment Restrictions. Licensee will not sell, resell, assign, lease, sublicense, encumber, or otherwise transfer its interest in this Agreement or in the Firmware, or the Documentation in whole or in part, or allow any other person or entity, including any parent or subsidiary of Licensee or other subsidiary of Licensee's parent, to copy, distribute, or otherwise transfer the Firmware without the prior written consent of Eaton. Licensee may transfer the Firmware directly to a third party only in connection with the sale of the Eaton product in which it is installed.

3.0 TERMINATION

3.1 Termination. This Agreement and the license granted hereunder automatically terminates if Licensee breaches any provision of this Agreement. Eaton may terminate this license at any time with or without cause.

3.2 Effect of Termination. Immediately upon termination of this Agreement or the license granted hereunder, Licensee will cease using the product. The parties' rights and obligations under the following sections of this Agreement will survive termination of this Agreement: Article 1.0, Section 2.1, Section 2.3, Section 2.4, Article 3.0, Article 4.0 and Article 5.0.

4.0 INFRINGEMENT AND WARRANTIES

4.1 Infringement. If Licensee learns of a threat, demand, allegation, or indication that the UPS with its firmware infringes or misappropriates any third party intellectual property rights (including but not limited to any patent, copyright, trademark, trade dress, or trade secret) ("Intellectual Property Claim"), Licensee will notify Eaton promptly of such claim. Eaton may, in its sole discretion, elect to assume sole control of the defense and settlement of said Intellectual Property Claim and Licensee will provide reasonable information and assistance to Eaton for the defense of such claim.

4.2 Disclaimer of Warranties. THE FIRMWARE IS PROVIDED "AS IS" WITHOUT WARRANTY OF ANY KIND. EATON DOES NOT WARRANT THAT THE FIRMWARE WILL BE ERROR-FREE OR SECURE FROM UNAUTHORIZED ACCESS. THE LICENSEE EXPRESSLY ACKNOWLEDGES THAT TO THE EXTENT PERMITTED BY APPLICABLE LAW, THE USE OF THE PRODUCT IS AT LICENSEE'S SOLE RISK.

5.0 GENERAL PROVISIONS

5.1 Update Policy. Eaton may from time to time, but has no obligation to, create Updates of the Firmware or components thereof.

5.2 Limitation on Liability. NOTWITHSTANDING ANY PROVISION OF THIS AGREEMENT TO THE CONTRARY, LICENSEE EXPRESSLY UNDERSTANDS AND AGREES THAT EATON, ITS AFFILIATES, AND ITS LICENSORS, WILL NOT BE LIABLE FOR: (A) ANY DIRECT, INDIRECT, INCIDENTAL, SPECIAL, CONSEQUENTIAL OR EXEMPLARY DAMAGES WHICH MAY BE INCURRED BY LICENSEE OR ANY THIRD PARTY, HOWEVER CAUSED AND UNDER ANY THEORY OF LIABILITY THIS WILL INCLUDE, BUT NOT BE LIMITED TO, ANY LOSS OF PROFIT (WHETHER INCURRED DIRECTLY OR INDIRECTLY), ANY LOSS OF GOODWILL OR BUSINESS REPUTATION, ANY LOSS OF DATA SUFFERED, COST OF PROCUREMENT OF SUBSTITUTE GOODS OR SERVICES, OR OTHER INTANGIBLE LOSS; (B) ANY LOSS OR DAMAGE WHICH MAY BE INCURRED BY LICENSEE OR ANY THIRD PARTY. THESE LIMITATIONS ON EATON'S LIABILITY WILL APPLY WHETHER OR NOT EATON HAS BEEN ADVISED OF OR SHOULD HAVE BEEN AWARE OF THE POSSIBILITY OF ANY SUCH LOSSES ARISING.

TO THE EXTENT PERMITTED BY LAW, THE TOTAL LIABILITY OF EATON, ITS AFFILIATES, AND ITS LICENSORS, FOR ANY CLAIMS UNDER THESE TERMS, INCLUDING FOR ANY IMPLIED WARRANTIES, IS LIMITED TO THE AMOUNT PAID FOR THE UPS.

THIS SECTION 5.2 STATES EATON'S ENTIRE LIABILITY AND LICENSEE'S SOLE AND EXCLUSIVE REMEDY UNDER THIS AGREEMENT, AND IS SUBJECT TO ALL LIMITATIONS STATED IN SECTION 4.2.

5.3 Notices. All notices required to be sent hereunder will be in writing and will be deemed to

have been given when mailed by first class mail to the address shown below:

LICENSE NOTICES:
Eaton Intelligent Power Limited
Eaton House,
30 Pembroke Road,
Dublin 4,
D04 Y0C2,
Ireland

5.4 Severability. If any provision of this Agreement is held to be invalid or unenforceable, the remaining provisions of this Agreement will remain in full force.

5.5 Waiver. The waiver by either party of any default or breach of this Agreement will not constitute a waiver of any other or subsequent default or breach. Failure to enforce or delay in enforcing any provision of this Agreement will not constitute a waiver of any rights under any provisions of this Agreement.

5.6 Entire Agreement. This Agreement constitutes the complete agreement between the parties and supersedes all prior or contemporaneous agreements or representations, written or oral, concerning the subject matter of this Agreement. This Agreement may not be modified or amended except in a writing specifically referencing this Agreement and signed by a duly authorized representative of each party. No other act, document, usage or custom will be deemed to amend or modify this Agreement. The Firmware, or portions thereof, may also be subject to additional paper or electronic license agreements. In such cases, the terms of this Agreement will be supplemental to those in the additional agreements, to the extent not inconsistent with the additional agreements. If a copy of this Agreement in a language other than English is included with the Firmware or Documentation, it is included for convenience and the English language version of this Agreement will control.

5.7 Heirs, Successors, and Assigns. Each and all of the covenants, terms, provisions and agreements herein contained will be binding upon and inure to the benefit of the parties hereto and, to the extent expressly permitted by this Agreement, their respective heirs, legal representatives, successors and assigns.

5.8 Export Restrictions. Licensee agrees to comply fully with all relevant export laws and regulations of the United States and all other countries in the world (the "Export Laws") to assure that neither the Firmware nor any direct product thereof are (i) exported, directly or indirectly, in violation of Export Laws; or (ii) are intended to be used for any purposes prohibited by the Export Laws. Without limiting the foregoing, Licensee will not export or re-export the Firmware: (i) to any country to which the U.S. has embargoed or restricted the export of goods or services (see <http://www.treasury.gov/resource-center/sanctions/Programs/Pages/Programs.aspx>), or to any national of any such country, wherever located, who intends to transmit or transport the Firmware back to such country; (ii) to any end user who Licensee knows or has reason to know will utilize the Firmware in the design, development or production of nuclear, chemical or biological weapons; or (iii) to any end-user who has been prohibited from participating in U.S. export transactions by any federal agency of the U.S. government.

5.9 U.S. Government Restricted Rights. The Firmware is a "commercial item" as that term is defined at 48 C.F.R. § 2.101, consisting of "commercial computer software" and "commercial computer software documentation", as such terms are used in 48 C.F.R. § 12.212, and is provided to the U.S. Government only as a commercial end item. Consistent with 48 C.F.R. § 12.212 and 48 C.F.R. §§ 227.7202-1 through 227.7202-4, all U.S. Government End Users acquire the Firmware with only those rights set forth herein. Contractor/manufacturer is Eaton Corporation, 1000 Eaton Boulevard, Cleveland, Ohio 44122.

5.10 Third Party Intellectual Property Rights. The Firmware may contain components (including open source software components) that are owned by third parties ("Third Party Licensors") and are provided with, incorporated into, or embedded in, the Firmware pursuant to license arrangements between Eaton and such third parties. Third Party Licensor components in the Firmware are not licensed or warranted under the terms of this document, but are instead subject to the Third Party Licensors' license agreements. Licensee will not modify, delete, or obfuscate any copyright or other proprietary rights notices of Third Party Licensors contained in the Firmware.

5.11 Indemnity. Licensee shall defend, indemnify and hold Eaton and its officers, directors, employees, and agents harmless from and against all losses, damages, liabilities, claims, actions, and associated costs and expenses (including reasonable attorneys' fees and expenses) by reason of injury or death to any person or damage to any tangible or intangible property arising or resulting from the negligence or willful misconduct of the Licensee, its employees, contractors, or agents, in connection with Licensee's use of Firmware and Documentation.

Licensee shall be responsible for any breach of this Agreement by its officers, directors, employees, contractors, or agents. Licensee shall defend, indemnify, and hold Eaton and its officers, directors, employees, and agents harmless from and against any and all losses, damages, liabilities, claims, actions, and associated costs and expenses (including reasonable attorneys' fees and expenses) arising out of or in connection with any breach of this Agreement.

5.12 Open Source Software. The Firmware may contain certain components owned by Eaton that are provided with, incorporated into, linked to, or embedded in the Firmware that are subject to third party open source licenses ("Eaton Open Source Components"). Eaton Open Source Components are subject to the open source licenses corresponding to the particular software component. To the extent there are any conflicts between the terms of this Agreement and any open source license corresponding to Eaton Open Source Components or additional obligations by such open sources license that are not set forth in this Agreement, the terms of the open source license will control.

5.13 Confidentiality. Licensee acknowledges that confidential aspects of the Firmware (including any proprietary source code) are a trade secret of Eaton, the disclosure of which would cause substantial harm to Eaton that could not be remedied by the payment of damages alone and such confidential aspects of the Firmware shall not be disclosed to third parties without the prior written consent of Eaton. Accordingly, Eaton will be entitled to preliminary and permanent injunctive and other equitable relief for any breach of this Section 5.13.

5.14 Note on JAVA Support. The Firmware may contain support for programs written in JAVA. JAVA technology is not fault tolerant and is not designed, manufactured, or intended for use, resale as online control equipment in hazardous environments requiring fail-safe performance, such as in the operation of nuclear facilities, aircraft navigation or communications systems, air traffic control, direct life support machines, or weapons systems, in which the failure of JAVA technology could lead directly to death, personal injury, or severe physical or environmental damage. EATON DISCLAIMS ALL DAMAGES INCLUDING DIRECT, INDIRECT AND CONSEQUENTIAL DAMAGES RELATING TO THE FAILURE OF ANY SOFTWARE INCLUDING JAVA PROGRAMS AND/OR JAVA TECHNOLOGY.

5.15 Governing Law. This Agreement will be interpreted and enforced in accordance with the laws of Ireland, without regard to choice of law principles. Any claim or suit with respect to this Agreement shall be brought in the Courts of Ireland, unless mandatory law imposes otherwise.

Eaton EULA

Table of Contents

1 Introduction	1
1.1 UPS Standard Features	1
1.1.1 Installation Features	1
1.1.2 Control Panel	3
1.1.3 Customer Interface	3
1.1.4 Energy Saver System Mode	3
1.1.5 Internal Redundancy	4
1.1.6 UL 924 Auxiliary Lighting and Power Equipment Certification	4
1.1.7 Advanced Battery Management	4
1.2 Options and Accessories	5
1.2.1 Integrated Battery Cabinet	5
1.2.2 Integrated Accessory Cabinet-Distribution	5
1.2.3 Integrated Accessory Cabinet-Power Distribution	5
1.2.4 Sidecar Integrated Accessory Cabinet-Bypass	5
1.2.5 Integrated Accessory Cabinet-Tie	5
1.2.6 Parallel System	5
1.2.7 Top Entry Wiring Sidecar	6
1.2.8 Monitoring and Communication	6
1.2.9 Additional Output Surge Protection	6
1.3 Battery System	6
1.4 Basic System Configurations	7
1.5 Using This Manual	7
1.6 Conventions Used in This Manual	7
1.7 Symbols, Controls, and Indicators	8
1.8 For More Information	8
1.9 Getting Help	9
1.10 Equipment Registration	9
2 Safety Warnings	11
3 UPS Installation Plan and Unpacking	13
3.1 Creating an Installation Plan	13
3.2 Preparing the Site	13
3.2.1 Environmental and Installation Considerations	13
3.2.2 UPS System Power Wiring Preparation	28
3.2.3 External Parallel UPS System Power Wiring Preparation	29
3.2.4 UPS System Interface Wiring Preparation	42
3.3 Inspecting and Unpacking the UPS Cabinets	44
4 UPS System Installation	47
4.1 Preliminary Installation Information	47

Table of Contents

4.2 Unloading the UPS Cabinet from the Pallet.....	47
4.3 Integrated Battery Cabinet Installation.....	51
4.4 Sidecar Integrated Accessory Cabinet-Bypass Wiring Installation.....	51
4.5 Integrated Accessory Cabinet-Tie.....	52
4.6 Integrated Accessory Cabinet-Distribution.....	52
4.7 Integrated Accessory Cabinet-Power Distribution.....	52
4.8 External AC Power Wiring Installation.....	52
4.9 Battery Power Wiring.....	58
4.10 Installing Interface Connections.....	59
4.10.1 Installing Building Alarm and Relay Contact Connections.....	59
4.10.2 Installing Battery Detect Interface Connections.....	65
4.10.3 Installing Battery Shunt Trip Interface Connections.....	66
4.10.4 Generator Interface Connections.....	70
4.10.5 Installing External Parallel CAN Control Wiring and Connections.....	71
4.10.6 Installing External Parallel Pull Chain Control Wiring and Connections.....	74
4.10.7 Installing Minislot Interface Connections.....	76
4.11 Installing a REPO Switch.....	77
4.12 Initial Startup.....	80
4.13 Completing the Installation Checklist.....	81
4.14 Installation Checklist.....	81
5 Understanding UPS Operation.....	83
5.1 UPS System Overview.....	83
5.2 Single UPS.....	84
5.2.1 Modes.....	84
5.2.2 Energy Saver System Mode.....	85
5.2.3 Normal Mode.....	86
5.2.4 Bypass Mode.....	87
5.2.5 Battery Mode.....	88
6 UPS Online Schematics.....	89
7 UPS Operating Instructions.....	95
7.1 UPS Controls and Indicators.....	95
7.2 Using the Control Panel.....	95
7.2.1 Status Indicators.....	96
7.2.2 System Events.....	97
7.2.3 Using the LCD Touch Screen.....	97
7.2.4 Using the Menu.....	98
7.2.5 Mimic Screen.....	99
7.2.6 Display Menu Operation.....	99
7.2.7 Sign In.....	105
7.2.8 System Controls.....	107

7.3 Single UPS Operation	110
7.3.1 Starting the UPS in Double Conversion Mode	110
7.3.2 Starting the UPS in Bypass Mode	111
7.3.3 Starting the UPS via DC Start Button	111
7.3.4 Starting the UPMs	112
7.3.5 Starting a Single UPM	113
7.3.6 Transfer from Double Conversion to Bypass Mode	113
7.3.7 Transfer from Bypass to Double Conversion Mode	113
7.3.8 Transfer from ESS Mode to Double Conversion Mode	113
7.3.9 Transfer from Double Conversion Mode to ESS Mode	114
7.3.10 Transfer from Double Conversion to Bypass Mode and Shut Down UPMs	114
7.3.11 Single UPM Shutdown	114
7.3.12 Single UPM Restart	115
7.3.13 UPS and Critical Load Shutdown	115
7.3.14 Charger Control	115
7.3.15 Battery Test	116
7.3.16 Using the UPS LOAD OFF Command	116
7.3.17 Using the Remote Emergency Power-off Switch	117
7.4 Multiple External Parallel System Operation	118
7.4.1 Starting the Parallel System in Double Conversion Mode	118
7.4.2 Starting the Parallel System in Bypass Mode	118
7.4.3 Starting the Parallel System UPMs	119
7.4.4 Starting a Single UPM	119
7.4.5 Transfer from Double Conversion to Bypass Mode	120
7.4.6 Transfer from Bypass to Double Conversion Mode	120
7.4.7 Transfer from ESS Mode to Double Conversion Mode	120
7.4.8 Transfer from Double Conversion Mode to ESS Mode	121
7.4.9 Transfer from Double Conversion to Bypass Mode and Shut Down all UPMs	121
7.4.10 Single UPM Shutdown	121
7.4.11 Single UPM Restart	122
7.4.12 Single UPS Shutdown	122
7.4.13 Single UPS Restart	122
7.4.14 Parallel System and Critical Load Shutdown	123
7.4.15 Charger Control	123
7.4.16 Battery Test	123
7.4.17 Using the LOAD OFF Command	124
7.4.18 Using the Remote Emergency Power-off Switch	124
8 Communication	127
8.1 Minislot Cards	127
8.2 Building Alarm Monitoring	128
8.3 General Purpose Relay Contact	128

Table of Contents

8.4 PredictPulse Remote Monitoring and Management Service.....	128
8.4.1 PredictPulse Service Features	128
8.4.2 Installing PredictPulse	129
9 UPS Maintenance.....	131
9.1 Important Safety Instructions	131
9.2 Performing Preventive Maintenance	131
9.2.1 DAILY Maintenance	132
9.2.2 MONTHLY Maintenance	132
9.2.3 PERIODIC Maintenance	133
9.2.4 ANNUAL Maintenance.....	133
9.2.5 BATTERY Maintenance.....	133
9.3 Installing Batteries	133
9.4 Recycling the Used Battery or UPS.....	134
9.5 Maintenance Training	134
10 Product Specifications.....	135
10.1 Model Numbers	135
10.2 Specifications.....	136
10.2.1 UPS Input.....	136
10.2.2 UPS Output	136
10.2.3 UPS Environmental	137
11 Warranty.....	139

List of Figures

Figure 1.	Eaton 93PM UPS – 150 kW Frame.....	2
Figure 2.	Eaton 93PM UPS – 150 kW Frame with Left or Right Mounted Top Entry Wiring Sidecar.....	2
Figure 3.	Eaton 93PM UPS – 150 kW Frame with Left or Right Mounted Bypass Sidecar (SIAC-B)	3
Figure 4.	UPS Cabinet Dimensions (Front and Right Side Views).....	18
Figure 5.	UPS Cabinet Dimensions (Top and Bottom Views)	19
Figure 6.	UPS Cabinet with Left or Right-Mounted Sidecar Dimensions (Front Views)	20
Figure 7.	UPS Cabinet with Left or Right-Mounted Sidecar Dimensions (Top and Bottom Views)	21
Figure 8.	UPS Cabinet with Left or Right-Mounted SIAC-B Dimensions (Front Views).....	22
Figure 9.	UPS Cabinet with Left or Right-Mounted SIAC-B Dimensions (Top and Bottom Views)	23
Figure 10.	UPS Cabinet Front and Back Floor Mounting Bracket Mounting Dimensions (Back Views)	24
Figure 11.	UPS Cabinet Center of Gravity	25
Figure 12.	UPS Cabinet with Left or Right-Mounted Top Entry Wiring Sidecar Center of Gravity	26
Figure 13.	UPS Cabinet with Left or Right-Mounted SIAC-B Center of Gravity	27
Figure 14.	Remote EPO Switch Dimensions	28
Figure 15.	93PM External Parallel Wire Length	30
Figure 16.	UPS Cabinet as Shipped on Pallet	45
Figure 17.	UPS Cabinet with Left or Right-Mounted Top Entry Wiring Sidecar as Shipped on Pallet.....	45
Figure 18.	UPS Cabinet with Left or Right-Mounted Bypass Sidecar (SIAC-B) as Shipped on Pallet	46
Figure 19.	Removing the Pallet Skids and Supports – Eaton 93PM UPS	48
Figure 20.	Removing the Sidecar Pallet Skids and Supports – Eaton 93PM UPS.....	49
Figure 21.	Removing the Sidecar Rear Shipping Bracket – Eaton 93PM UPS	51
Figure 22.	UPS Conduit and Wire Entry Locations	54
Figure 23.	Sidecar Conduit and Wire Entry Locations	55
Figure 24.	UPS Inter-Cabinet Wiring Access Location.....	56
Figure 25.	Power Terminal Locations.....	57
Figure 26.	Power Terminal Detail	58
Figure 27.	Interface Terminal Locations.....	60
Figure 28.	Interface Terminal Detail.....	61
Figure 29.	Bottom Access Interface Wiring Location.....	62
Figure 30.	Wire Tie Anchors	63
Figure 31.	Building Alarm Terminal Block Connector Assignments.....	64
Figure 32.	Relay Contact Terminal Block Connector Assignments.....	64
Figure 33.	Battery Shunt Trip Location	68
Figure 34.	Battery Shunt Trip Terminal Detail.....	69
Figure 35.	Battery Shunt Trip Terminal Assignments.....	69
Figure 36.	External Parallel CAN Wiring.....	73
Figure 37.	External Parallel Terminal Block	73
Figure 38.	External Parallel Pull Chain Wiring	75
Figure 39.	REPO Switch	78

List of Figures

Figure 40.	REPO Terminal Block Connector Assignments	78
Figure 41.	Normally-Open REPO Switch Wiring	79
Figure 42.	Normally-Closed REPO Switch Wiring	80
Figure 43.	Main Elements of the UPS System	83
Figure 44.	Path of Current Through the UPS in Energy Saver System Mode.....	85
Figure 45.	Path of Current Through the UPS in Normal Mode.....	86
Figure 46.	Path of Current Through the UPS in Bypass Mode.....	87
Figure 47.	Path of Current Through the UPS in Battery Mode.....	88
Figure 48.	Eaton 93PM UPS System Oneline	90
Figure 49.	Eaton 93PM UPS System with Two-Breaker Bypass Oneline.....	91
Figure 50.	Eaton 93PM UPS System with Three-Breaker Bypass Oneline.....	92
Figure 51.	Eaton 93PM UPS System with Four-Breaker Bypass Oneline	93
Figure 52.	UPS Controls and Indicators	95
Figure 53.	UPS Control Panel	96
Figure 54.	Parts of the LCD	98
Figure 55.	Main Menu and Mimic Screen	99
Figure 56.	Typical Meters Summary Screen	101
Figure 57.	Typical Active Events Screen	102
Figure 58.	Typical System Log Screen	102
Figure 59.	Typical Settings User Screen	103
Figure 60.	Typical Information Screen	103
Figure 61.	Typical About Screen	104
Figure 62.	Typical Settings Configuration 1 Screen	104
Figure 63.	Typical Settings Configuration 2 Screen	105
Figure 64.	Typical Statistics Screen	105
Figure 65.	Sign In Password Screen	106
Figure 66.	Sign In Keypad.....	106
Figure 67.	Typical System Control Screen	108
Figure 68.	Typical UPS Control Screen	108
Figure 69.	Typical UPM Select Screen	109
Figure 70.	Typical UPM Control Screen	109
Figure 71.	Typical EAA Control Screen	110
Figure 72.	DC Start Button Location	112
Figure 73.	REPO Operation	118
Figure 74.	Optional Minislot Cards	127
Figure 75.	Air Filter Location	133

List of Tables

Table 1.	G1 Equipment Data from ANSI/ISA-71.04-2013	15
Table 2.	Air Conditioning or Ventilation Requirements During Full Load Operation.....	15
Table 3.	UPS Cabinet Weights	16
Table 4.	UPS Cabinet Clearances	17
Table 5.	Input/Output Ratings and Wiring Recommendations: Eaton 93PM-150-1 and 93PM-150-2 (N+1).....	31
Table 6.	Input/Output Ratings and Wiring Recommendations: Eaton 93PM-150-2 and 93PM-150-3 (N+1).....	32
Table 7.	Input/Output Ratings and Wiring Recommendations: Eaton 93PM-150-3.....	33
Table 8.	UPS External Power Cable Terminations	35
Table 9.	Power Cable Conduit Recommendations.....	36
Table 10.	Recommended Input and Bypass Circuit Breaker Ratings	39
Table 11.	Recommended Output Circuit Breaker Ratings	40
Table 12.	Recommended DC Input Battery Disconnect Circuit Breaker Ratings (216 Cell)	41
Table 13.	Recommended DC Input Battery Disconnect Circuit Breaker Ratings (240 Cell)	42
Table 14.	Building Alarm Connections and Wire Terminations	63
Table 15.	Relay Contact Connections and Wire Terminations	64
Table 16.	Battery Shunt Trip Connections and Wire Terminations	69
Table 17.	External Parallel CAN and Pull Chain Connections.....	72
Table 18.	External Parallel CAN and Pull Chain Terminal Block Terminations.....	72
Table 19.	Normally-Open REPO Connections and Wire Terminations.....	79
Table 20.	Normally-Closed REPO Connections and Wire Terminations.....	79
Table 21.	Status Indicators	97
Table 22.	Display Function Menu Map	99
Table 23.	Display Menu Operation	100
Table 24.	Controls Menu Operation	107
Table 25.	Typical System Status Messages.....	107
Table 26.	IRC-MS Default Triggers	127

List of Tables

Chapter 1 Introduction

The Eaton® 93PM, Three-Wire – 150 kW Frame uninterruptible power supply (UPS) is a true online, continuous-duty, transformerless, double-conversion, solid-state, three-phase system, providing conditioned and uninterruptible AC power to protect the customer's load from power failures.

The Eaton 93PM UPS' online power protection system is used to prevent loss of valuable electronic information, minimize equipment downtime, and minimize the adverse effect on production equipment due to unexpected power problems.

The Eaton 93PM UPS continually monitors incoming electrical power and removes the surges, spikes, sags, and other irregularities that are inherent in commercial utility power. Working with a building's electrical system, the UPS system supplies clean, consistent power that sensitive electronic equipment requires for reliable operation. During brownouts, blackouts, and other power interruptions, batteries provide emergency power to safeguard operation.

The Eaton 93PM UPS is available with one, two, or three Uninterruptible Power Modules (UPMs) integrated in one cabinet. Each UPM is rated for a maximum of 50 kW. The system maximum rating is 150 kW. To deliver greater reliability, UPS with two or three UPMs can provide N+1 redundancy up to a maximum of 50 kW and 100 kW respectively. Should one UPM become unavailable or require servicing, the remaining UPM supplies the load instead of transferring to bypass.

The UPS is housed in a single free-standing cabinet, with safety shields behind the door for hazardous voltage protection. Power wiring is installed through the bottom of the cabinet with an optional sidecar available for top entry wiring. [Figure 1](#) shows the Eaton 93PM – 150 kW Frame UPS, [Figure 2](#) shows the Eaton 93PM – 150 kW Frame UPS with a left or right-mounted top entry wiring sidecar, and [Figure 3](#) shows the Eaton 93PM – 150 kW Frame UPS with a left or right-mounted bypass sidecar (SIAC-B).

NOTE

Startup and operational checks must be performed by an authorized Eaton Customer Service Engineer, or the warranty terms specified on the product's resources page become void. See [Chapter 11 Warranty](#) for details. This service is offered as part of the sales contract for the UPS. Contact an Eaton service representative in advance (a minimum two-week notice is required) to reserve a preferred startup date.

1.1 UPS Standard Features

The UPS has many standard features that provide cost-effective and consistently reliable power protection. The descriptions in this section provide a brief overview of the UPS standard features.

1.1.1 Installation Features

- Line-up-and-match or standalone configurations
- Power wiring can be routed through the bottom of the cabinet
- Battery wiring can be run internally through the left or right sides of the UPS cabinet in line-up-and-match configurations
- Easily accessible mechanical terminals located at the bottom front of the cabinet reduce installation time
- Control wiring can be routed through the top or bottom of the UPS cabinet, or through the left or right sides of the UPS cabinet in line-up-and-match configurations
- Built-in casters for easy cabinet placement
- Cabinet bolt holes are provided for permanently mounting the UPS using optional front and back or left and right side floor mounting bracket kits

Figure 1. Eaton 93PM UPS – 150 kW Frame



Figure 2. Eaton 93PM UPS – 150 kW Frame with Left or Right Mounted Top Entry Wiring Sidecar



UPS with Left-Mounted Sidecar



UPS with Right-Mounted Sidecar

Figure 3. Eaton 93PM UPS – 150 kW Frame with Left or Right Mounted Bypass Sidecar (SIAC-B)

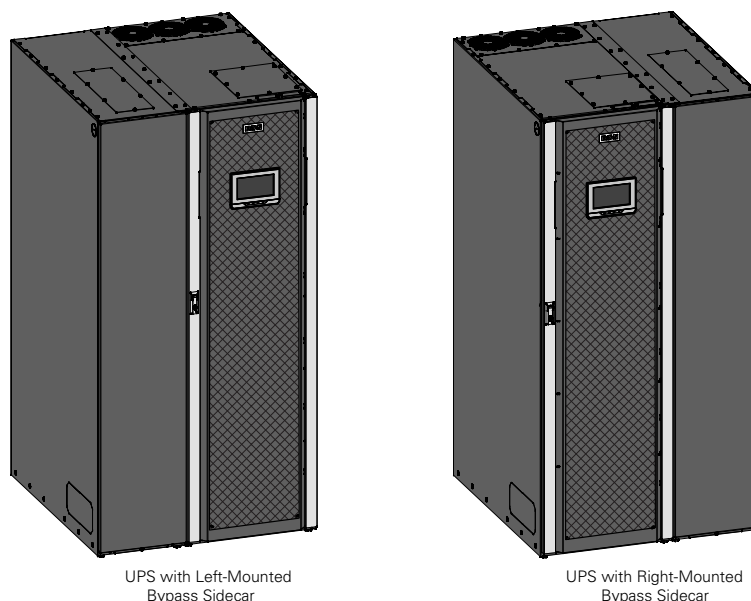

1.1.2 Control Panel

The control panel, located on the front of the UPS, contains a color liquid crystal touch screen display (LCD) and a horizontal row of LED indicators to control the operation of the UPS and to display the status of the UPS system. See [Chapter 7 UPS Operating Instructions](#), for additional information.

1.1.3 Customer Interface

- **Building Alarm Monitoring** – Up to five inputs in the UPS are available to connect the facility's alarm system contacts. Some system configurations may limit the number of inputs available. The UPS uses these inputs to monitor the building alarms in addition to the UPS status.
- **Alarm Contact** – One alarm contact is provided for connection to equipment at the facility, such as a light, an audible alarm, or a computer terminal. The equipment connected to this contact alerts you to a UPS alarm.
- **Minislot Communication Bays** – Four communication bays are standard equipment. One to four optional Minislot® connectivity cards can be installed in the UPS at any time. Minislot cards are quickly installed at the front of the UPS and are hot-pluggable.

For additional information on these topics, see [Chapter 8 Communication](#).

1.1.4 Energy Saver System Mode

The 93PM Series UPS offers an Energy Saver System (ESS) mode that maximizes efficiency by eliminating unnecessary power conversion when the commercial power source is within acceptable voltage and frequency limits. In this mode, the UPS is actively monitoring the critical bus and instantly and seamlessly transitions to double-conversion mode (inverter online) if a commercial electrical power brownout, blackout, overvoltage, undervoltage, or out-of-tolerance frequency condition occurs. See [Chapter 7 UPS Operating Instructions](#), for additional information.

1.1.5 Internal Redundancy

To deliver greater reliability, the Eaton 93PM UPS can be configured for internal redundancy. When configured, the UPS automatically becomes redundant if the load is at or below the capacity of the UPMs minus the capacity of one UPM. Under normal conditions the UPMs in the UPS share the load equally. If one or more UPMs becomes unavailable and the load is at or below the capacity of remaining UPMs, the remaining UPMs supply the load instead of transferring to bypass.

1.1.6 UL 924 Auxiliary Lighting and Power Equipment Certification

93PM models are complementary listed for “UL 924 Auxiliary Lighting and Power Equipment”, which allows alternative battery runtimes to be used.



Emergency Power Off (EPO) and Remote Emergency Power Off (REPO) functionality is disabled for UPS systems configured for UL 924 auxiliary lighting. To remove power from the system, a LOAD OFF command (see paragraph [7.3.16 Using the UPS LOAD OFF Command](#) or [7.4.17 Using the LOAD OFF Command](#)) must be given using the front panel controls and all breakers opened.

1.1.7 Advanced Battery Management

Advanced Battery Management (ABM) technology uses sophisticated sensing circuitry and a three-stage charger. The charger is a high-frequency, IGBT-based power conversion stage that extends the useful service life of UPS batteries by isolating the battery from the electrical environment, except for periodic charging or reserve mode operation. ABM also protects batteries from damage due to high current charging and inverter ripple currents. Charging at high currents can overheat and damage batteries.

ABM extends battery life by keeping the batteries charged and performing periodic battery testing. The battery test checks the batteries by transferring to battery mode. During the test the battery voltage is constantly monitored to determine Battery Health. ABM is intended for VRLA style batteries.

An ABM charging cycle starts with the charger driving the battery voltage at maximum current limit, to a battery charge level of 2.30volts/cell. The time it takes for the voltage to reach the battery charge level is saved as the battery charge time. If the battery charge time exceeds 24 hours, an alarm sounds.

When the battery reaches the float level, the battery is charged at the float level for 48 hours. Due to charger capability, some battery cabinet configurations extend float level to 72 hours. Twenty-four hours into the float period, a series of battery tests are performed to check the battery health. The float level charge continues after a successful test.

After initial startup, the battery run time on the front panel display indicates two minutes. After the 24-hour float charging period and automated battery testing, the actual battery run time is determined and the actual battery run time is displayed.

After the float period is completed, the charger is disconnected and the batteries are allowed to rest for up to 672 hours (28 days) maximum rest time. If the battery voltage falls below the opportunity charge level of 2.1V/cell during the first 240 hours (10 days) of the rest period, an alarm sounds.

An ABM charge cycle is initiated whenever one of these four conditions occurs since the last charge cycle:

- The batteries have rested over the maximum rest time of 672 hours.
- Accumulated discharge time is over a maximum battery discharge time of 20 seconds.
- Battery voltage is under the opportunity charge level of 2.1 volts/cell and the cabinet has been in rest mode for longer than 240 hours.
- A Battery Test command has been initiated.

1.2 Options and Accessories

Contact an Eaton sales representative for information about the following options.

1.2.1 Integrated Battery Cabinet

Battery backup protection with additional runtime can be provide by equipping the UPS system with up to four Integrated Battery Cabinets (IBCs) containing sealed lead-acid, maintenance-free batteries. The IBCs are housed in single, free-standing cabinets designed for line-up-and-match installation, but may be installed separate from the UPS cabinet. An external battery disconnect switch or tie point must be used when three or four IBCs are located separate from the UPS cabinet. The IBCs may be installed on either the right or left side of the UPS cabinet. The recommended installation location for adjacent battery cabinets is on the right side of the UPS cabinet.

1.2.2 Integrated Accessory Cabinet-Distribution

The Integrated Accessory Cabinet-Distribution (IAC-D) provides power distribution with up to 2 42-pole distribution panels or up to five 3-pole 100- 250A adjustable subfeed breakers. The IAC-D is housed in a single, free-standing cabinet designed for line-up-and-match installation, but may be installed separate from the UPS cabinet. The recommended installation location for an adjacent IAC-D is to the left of the UPS cabinet.

1.2.3 Integrated Accessory Cabinet-Power Distribution

An Integrated Accessory Cabinet-Power Distribution (IAC-PD) provides power distribution options for servers, racks, and other equipment via distribution panelboards, or distributes power to larger loads via distribution subfeed circuit breakers. The distribution options are customer configurable, enabling adaptation and expansion without costly electrical rework.

1.2.4 Sidecar Integrated Accessory Cabinet-Bypass

A Sidecar Integrated Accessory Cabinet-Bypass (SIAC-B) provides maintenance bypass functions. The SIAC-B is available in two, three, or four breaker configurations enabling power to completely bypass the UPS. The UPS can then be safely serviced or replaced without interrupting power to critical systems. The four breaker configuration provides a convenient method for removing power from the UPS when using the maintenance bypass to supply the load. The SIAC-B is housed in a cabinet that is attached to the UPS cabinet. The SIAC-B may be installed on either the right or left side of the UPS cabinet. The SIAC-B can also be used for top entry wiring access.

1.2.5 Integrated Accessory Cabinet-Tie

An Integrated Accessory Cabinet-Tie (IAC-T) provides the ability to parallel up to four UPSs together for increased capacity and/or redundant capability. The IAC-T is housed in a single, free-standing cabinet designed for line-up-and-match installation, but may be installed separate from the UPS cabinet. The recommended installation location for an adjacent IAC-D is to the left of the UPS cabinet.

1.2.6 Parallel System



NOTE

All UPSs in a parallel system must have the same battery configuration. Each UPS requires a separate battery cabinet.

A parallel UPS system with up to eight UPSs can be installed to provide a parallel capacity and/or redundant system. This load sharing system provides more capacity than a single UPS, and can provide backup, depending on the load and configuration. In addition, when one UPS is taken out of service for maintenance or is not operating properly, a redundant UPS continues to supply uninterrupted power to the critical load. A built-in Controller Area Network (CAN) provides connectivity for system metering and operational mode control. The parallel system consists of two to four UPSs each with a parallel CAN, and an IAC-T to act as a tie point and to control the output.

1.2.7 Top Entry Wiring Sidecar

If required, a sidecar is available for top entry power wiring. The sidecar performs the function of a wireway routing the wires to the terminals mounted at the bottom of the UPS cabinet. The sidecar can be installed on the left or right side of the UPS cabinet.

1.2.8 Monitoring and Communication

Minislot Cards – Optional Minislot cards support several protocols, such as SNMP, SMTP, HTTP, Modbus®, and TCP/IP. See [Chapter 8 Communication](#) for additional information on monitoring and communication features.

Remote Monitoring Device (RMD) – An optional RMD contains a touch screen status display and a local audible alarm, allowing monitoring of the operational status and alarm condition of the UPS from virtually any location within the facility, up to 300 feet from the UPS. Refer to the *Eaton Remote Monitoring Device (RMD) Installation and Operation Manual*, listed in paragraph [1.8 For More Information](#), for additional information.

PredictPulse™ Remote Monitoring and Management Service– PredictPulse is a subscription monitoring and management service from Eaton that collects and analyzes data from connected power infrastructure devices, providing us with the insight needed to make recommendations and take action on your behalf. It's also powered by CA Technologies, bringing together the best in hardware and software. Like a second set of eyes on your power infrastructure, PredictPulse provides 24/7 remote monitoring of alarms and system performance (load, temperature/humidity, battery health, energy savings and service level) to reduce downtime risk and expedite repairs. PredictPulse also shares real-time status and trend information via an online dashboard and smartphone mobile app (Apple and Android), giving subscribers insights about past and current performance, a list of all active alarms, and asset management data (i.e., battery date codes, last and next scheduled service dates, firmware versions). The service notifies customers of critical alarms, supports remote diagnostics, and facilitates smart dispatch of technicians. PredictPulse requires a Power Xpert® Gateway Minislot (PXGMS) connectivity card in an Minislot communication bay and an Environmental Monitoring Probe (EMP) for battery temperature/humidity monitoring. See [Chapter 8 Communication](#) for additional information on monitoring and communication features.

1.2.9 Additional Output Surge Protection

The Eaton 93PM UPS complies with ANSI 62.41 for line surges. However, if added security is required an additional Surge Protection Device (SPD) can be installed. For this application, a 480V Delta Style SPD Type 1 or Type 2 installed on the load side is recommended. The SPD must meet the Maximum Continuous Operating Voltage (MCOV) for a 480V Delta Style SPD. Eaton offers a variety of SPD solutions including the Eaton SPD Series with various kA ratings options.

1.3 Battery System

Although not provided with the UPS, a battery system is required to provide emergency short-term backup power to safeguard operation during brownouts, blackouts, and other power interruptions. The battery system should be equipped with lead-acid batteries. An external battery disconnect switch or tie point must be used when battery systems are located separate from the UPS cabinet and wiring exceeds the number of battery terminals available.

A supplemental 48 Vdc shunt trip signal for the battery disconnect device is provided by the UPS, but is not required for normal operation.

1.4 Basic System Configurations

The following basic UPS system configurations are possible:

- Single UPS (20–100 kW) with one to four standard external battery cabinets
- Single UPS (110–150 kW) with two to four standard external battery cabinets
- Single UPS (20–100 kW) with one to four standard external battery cabinets and accessory cabinets
- Single UPS (110–150 kW) with two to four standard external battery cabinets and accessory cabinets
- Two to four UPSs (20–100 kW) with one to four standard external battery cabinets for each UPS
- Two to four UPSs (110–150 kW) with two to four standard external battery cabinets for each UPS
- Two to four UPSs (20–100 kW) with one to four standard external battery cabinets for each UPS and accessory cabinets
- Two to four UPSs (110–150 kW) with two to four standard external battery cabinets for each UPS and accessory cabinets

The UPS system configuration can be enhanced by adding optional accessories such as a Remote Emergency Power-off (REPO) control or Minislot communication cards.

1.5 Using This Manual

This manual describes how to install and operate the Eaton 93PM. Read and understand the procedures described in this manual to ensure trouble-free installation and operation. In particular, be thoroughly familiar with the Remote Emergency Power Off (REPO) and the LOAD OFF procedures detailed in [Chapter 7 UPS Operating Instructions](#).

The information in this manual is divided into sections and chapters. The system, options, and accessories being installed dictate which parts of this manual should be read. At a minimum, [Chapter 1 Introduction](#) through [Chapter 4 UPS System Installation](#) and [Chapter 7 UPS Operating Instructions](#) should be examined.

Read through each procedure before beginning the work. Perform only those procedures that apply to the UPS system being installed or operated.

1.6 Conventions Used in This Manual

This manual uses these type conventions:

- **Bold type** highlights important concepts in discussions, key terms in procedures, and menu options, or represents a command or option that you type or enter at a prompt.
- *Italic type* highlights notes and new terms where they are defined.
- `screen type` represents information that appears on the screen or LCD.

Icon	Description
Note	Information notes call attention to important features or instructions.
[Keys]	Brackets are used when referring to a specific key, such as [Enter] or [Ctrl].

In this manual, the term UPS refers only to the UPS cabinet and its internal elements. The term UPS system refers to the entire power protection system – the UPS cabinet, an external battery system, and options or accessories installed.

The term line-up-and-match refers to accessory cabinets that are physically located adjacent to the UPS. The term standalone refers to accessory cabinets that are located separate from the UPS.

Left and right side notations are referenced standing in front of the cabinet.

1.7 Symbols, Controls, and Indicators

The following are examples of symbols used on the UPS or accessories to alert you to important information:



RISK OF ELECTRIC SHOCK - Observe the warning associated with the risk of electric shock symbol.



CAUTION: REFER TO OPERATOR'S MANUAL - Refer to your operator's manual for additional information, such as important operating and maintenance instructions.



This symbol indicates that you should not discard the UPS or the UPS batteries in the trash. This product contains sealed, lead-acid batteries and must be disposed of properly. For more information, contact your local recycling/reuse or hazardous waste center.



This symbol indicates that you should not discard waste electrical or electronic equipment (WEEE) in the trash. For proper disposal, contact your local recycling/reuse or hazardous waste center.

1.8 For More Information

Refer to the *Eaton 93PM Integrated Battery Cabinet Installation Manual – Large and Large High Rate*, the *Eaton 93PM Universal Integrated Battery Cabinet Installation Manual-Large and Large High Rate*, the *Eaton 93PM Integrated Battery Cabinet-Small IBC-S Installation Manual*, or the *Eaton 93PM Integrated Battery Cabinet-Small Welded IBC-SW (432V and 480V) Installation Manual*, for the following additional information:

- Installation instructions, including site preparation, planning for installation, wiring and safety information, and detailed illustrations of cabinets with dimensional and connection point drawings

Refer to the *Eaton 93PM Sidecar Integrated Accessory Cabinet-Bypass (150 kW and 200 kW SIAC-B) Installation and Operation Manual* for the following additional information:

- Installation instructions, including site preparation, planning for installation, wiring and safety information, and detailed illustrations of cabinets with dimensional and connection point drawings
- Operation, including breakers, standard features and optional accessories, procedures for using the bypass functions, and information about maintenance

Refer to the *Eaton 93PM Integrated Accessory Cabinet-Tie (150 kW and 200 kW) Installation and Operation Manual* for the following additional information:

- Installation instructions, including site preparation, planning for installation, wiring and safety information, and detailed illustrations of cabinets with dimensional and connection point drawings
- Operation, including breakers, standard features and optional accessories, procedures for using the bypass functions, and information about maintenance

Refer to the *Eaton 93PM Integrated Accessory Cabinet-Distribution (50 kW, 100 kW, 150 kW, and 200 kW IAC-D) Installation and Operation Manual* for the following additional information:

- Installation instructions, including site preparation, planning for installation, wiring and safety information, and detailed illustrations of cabinets with dimensional and connection point drawings

- Operation, including breakers, standard features and optional accessories, procedures for using the distribution functions, and information about maintenance

Refer to the *Eaton 93PM Integrated Accessory Cabinet-Power Distribution (IAC-PD) Installation and Operation Manual* for the following additional information:

- Installation instructions, including site preparation, planning for installation, wiring and safety information, and detailed illustrations of cabinets with dimensional and connection point drawings
- Operation, including breakers, standard features and optional accessories, procedures for using the bypass functions, and information about maintenance

Refer to the *Eaton Remote Monitoring Device (RMD) Installation and Operation Manual* for additional installation and operating instructions.

Visit www.eaton.com/powerquality or contact an Eaton service representative for information on how to obtain copies of these manuals.

1.9 Getting Help

If help is needed with any of the following:

- Scheduling initial startup
- Regional locations and telephone numbers
- A question about any of the information in this manual
- A question this manual does not answer

Please call the Customer Reliability Center at:

United States:	1-800-843-9433
Canada:	1-800-461-9166 ext 260
All other countries:	Call your local service representative

Please use the following e-mail address for manual comments, suggestions, or to report an error in this manual:

E-ESSDocumentation@eaton.com

1.10 Equipment Registration

Please visit www.eaton.com/pg/register to register your new Eaton UPS / Eaton UPS Accessory.

Model Number:

Serial Number:

Chapter 2 Safety Warnings

IMPORTANT SAFETY INSTRUCTIONS - SAVE THESE INSTRUCTIONS

This manual contains important instructions that should be followed during installation and maintenance of the UPS and batteries. Read all instructions before operating the equipment and save this manual for future reference.

The UPS is designed for industrial or computer room applications, and contains safety shields behind the door and front panels. However, the UPS is a sophisticated power system and should be handled with appropriate care.



This UPS contains LETHAL VOLTAGES. All repairs and service should be performed by AUTHORIZED SERVICE PERSONNEL ONLY. There are NO USER SERVICEABLE PARTS inside the UPS.



-
- The UPS is powered by its own energy source (batteries). The output terminals may carry live voltage even when the UPS is disconnected from an AC source.
 - To reduce the risk of fire or electric shock, install this UPS in a temperature and humidity controlled, indoor environment, free of conductive contaminants. Ambient temperature must not exceed 40°C (104°F). Do not operate near water or excessive humidity (95% maximum). The system is not intended for outdoor use.
 - As a result of the connected loads high leakage current is possible. Connection to earth ground is required for safety and proper product operation. Do not check UPS operation by any action that includes removal of the earth (ground) connection with loads attached.
 - Emergency Power Off (EPO) and Remote Emergency Power Off (REPO) functionality is disabled for UPS systems configured for UL 924 auxiliary lighting. To remove power from the system a LOAD OFF command must be given using the front panel controls and all breakers opened. Review **Chapter 7 UPS Operating Instructions**, for details.
 - Ensure all power is disconnected before performing installation or service.
 - Batteries can present a risk of electrical shock or burn from high short-circuit current. The following precautions should be observed: 1) Remove watches, rings, or other metal objects; 2) Use tools with insulated handles; 3) Do not lay tools or metal parts on top of batteries; 4) Wear voltage rated gloves and electrical hazard footwear.
 - ELECTRIC ENERGY HAZARD. Do not attempt to alter any UPS or battery wiring or connectors. Attempting to alter wiring can cause injury.
 - Do not open or mutilate batteries. Released electrolyte is harmful to the skin and eyes. It may be toxic.
-

CAUTION

- Installation or servicing should be performed by qualified service personnel knowledgeable of UPS and battery systems, and required precautions. Keep unauthorized personnel away from equipment. Consider all warnings, cautions, and notes before installing or servicing equipment. **DO NOT DISCONNECT** the batteries while the UPS is in Battery mode.
- Replace batteries with the same number and type of batteries as originally installed with the UPS.
- Disconnect the charging source prior to connecting or disconnecting terminals.
- Proper disposal of batteries is required. Refer to local codes for disposal requirements.
- Do not dispose of batteries in a fire. Batteries may explode when exposed to flame.
- Keep the UPS door closed and front panels installed to ensure proper cooling airflow and to protect personnel from dangerous voltages inside the unit.
- Do not install or operate the UPS system close to gas or electric heat sources.
- Lead-acid batteries can present a risk of fire because they generate hydrogen gas. Do not smoke when near batteries. Do not cause flame or spark in battery area. Discharge static electricity from body before touching batteries by first touching a grounded metal surface.
- The operating environment should be maintained within the parameters stated in this manual.
- Keep surroundings uncluttered, clean, and free from excess moisture.
- Observe all DANGER, CAUTION, and WARNING notices affixed to the inside and outside of the equipment.

**AVERTISSEMENT!**

- Les batteries peuvent présenter un risque de décharge électrique ou de brûlure par des courts-circuits de haute intensité. Prendre les précautions nécessaires.
- Pour le remplacement, utiliser le même nombre et modèle des batteries.

**ATTENTION!**

- Une mise au rebut réglementaire des batteries est obligatoire. Consulter les règlements en vigueur dans votre localité.
 - Ne jamais jeter les batteries au feu. L'exposition aux flammes risque de les faire exploser.
 - Les accumulateurs au plomb-acide peuvent représenter un risque d'incendie, car ils génèrent de l'hydrogène gazeux. Ne pas fumer près des accumulateurs. Ne pas produire de flamme ou d'étincelle dans la zone de l'accumulateur. Dissiper l'électricité statique de votre corps en touchant une surface reliée à la terre avant de toucher les accumulateurs.
-

Chapter 3 UPS Installation Plan and Unpacking

Use the following basic sequence of steps to install the UPS:

1. Create an installation plan for the UPS system.
2. Prepare your site for the UPS system.
3. Inspect and unpack the UPS cabinet.
4. Unload and install the UPS cabinet, and wire the system.
5. Install features, accessories, or options, as applicable.
6. Complete the Installation Checklist.
7. Have authorized service personnel perform preliminary operational checks and start up the system.



NOTE

Startup and operational checks must be performed by an authorized Eaton Customer Service Engineer, or the warranty terms specified on the product's resources page become void. See [Chapter 11 Warranty](#) for details. This service is offered as part of the sales contract for the UPS. Contact an Eaton service representative in advance (a minimum two-week notice is required) to reserve a preferred startup date.

3.1 Creating an Installation Plan

Before installing the UPS system, read and understand how this manual applies to the system being installed. Use the procedures and illustrations in this chapter and **Chapter 4 Installation** to create a logical plan for installing the system.

3.2 Preparing the Site

For the UPS system to operate at peak efficiency, the installation site should meet the environmental parameters outlined in this manual. The operating environment must meet the weight, clearance, and environmental requirements specified.

3.2.1 Environmental and Installation Considerations

General storage requirements for UPS Equipment:

- Equipment which cannot be immediately installed and energized should be stored in an indoor, dry, clean, ventilated area, heated environment (i.e. an temperature and humidity controlled environment). The storage area must be protected from rain, water, chemical agents and gases as shown in [Table 1](#).
- Do not store in areas where conditions such as dampness, changes in temperature, dust, dirt, rubble, paint, conductive particulates, or corrosive atmosphere / gases are present.
- Factory installed packaging and wrapping of the equipment should not be removed until equipment is ready to install.
- Equipment should be checked periodically for any signs of deterioration. It is the responsibility of the receiving contractor to ensure protection during storage.
- Equipment should be placed on true and solid level surfaces for storage.
- Have a plan for condensation and environmental mitigation prior to equipment arrival.

The UPS system installation must meet the following guidelines:

- The system must be installed on a level floor suitable for computer or electronic equipment.

- The system must be operated at an altitude no higher than 1500m (5000 ft) without derating. For additional assistance with high altitude operation, contact an Eaton service representative (see paragraph [1.9 Getting Help](#)).
- The system must be installed in a temperature and humidity controlled indoor area free of conductive contaminants.

CAUTION

Do not expose the UPS to overly aggressive environments, like salt mist or corrosive gases. High relative humidity accelerates the effects of contaminants. The UPS should be installed in a G1 environment (based on ANSI/ISA S-71.04 classifications). If the UPS is used in a more aggressive environment, it can cause reduced product life and possibly early failure. If the installation location does not meet the recommended environment, contact Eaton service representative for further information (see paragraph).

- The environmental requirements specified below are for the air at the intake ports of the 93PM UPS, and are the maximum, not to exceed, ratings.
 - There shall be at least a 1.8°F (1.0°C) difference between the dry bulb temperature and the wet bulb temperature, at all times, to maintain a non-condensing environment.
 - The maximum rate of temperature change shall be limited to 3°F over 5 minutes (36°F/hour), based on the ASHRAE Standard 90.1-2013.
- The newer, more energy efficient data center cooling methods (such as air side economization) can create much wider ranges of temperature and Relative Humidity (RH) in the UPS room and/or data center. There are two aspects of this increased operating environment that can, if ignored, create issues.
 - One is the creation of microclimates, which are persistent variations of temperature and/or RH within a single room. For example one side of the room is always cooler than the other side, no matter the actual temperature.
 - The other aspect is the rate of change of temperature and/or RH, which can occur during transitions within the cooling system. Examples: changing the mixture ratio of inside versus outside air, or external changes in the outside air when going from night to day, and back to night.
 - When ignored, either one of these aspects can create an undesirable microclimate at the UPS location. If the environment created by this microclimate exceeds the UPS operating specification, the UPS reliability, over time, will be reduced. These same environmental extremes will also create reliability concerns for any servers that are exposed to them.

Failure to follow guidelines may void your warranty.

The basic environmental requirements for operation of the UPS are:

- Storage Temperature: -25°C to +55°C (-13°F to 131°F)
- Ambient Temperature Range: 5°C to +40°C (41°F to 104°F)
- Recommended Operating Temperature Range: -0°C to +40°C (32°F to 104°F)
- Storage and Use Maximum Relative Humidity: 5 to 95%, noncondensing
 - There shall be at least a 1.8°F (1.0°C) difference between the dry bulb temperature and the wet bulb temperature, always, to maintain a non-condensing environment
- This product was designed for installation and use in a G1 environment as defined in ANSI/ISA-71.04-2013. Refer to [Table 1](#) for gas concentration limits.

Table 1. G1 Equipment Data from ANSI/ISA-71.04-2013

Contaminant	Gas	Gas Concentration in ppbv
Group A	H ₂ S	<3
	SO ₂ /SO ₃	<10
	Cl ₂	<1
	NO _x	<50
Group B	HF	<1
	NH ₃	<500
	O ₃	<2

NOTE Table information copied from Table B1 of ANSI/ISA-71.04-2013 for G1 equipment

CAUTION

If battery systems are located in the same room as the UPS, the battery manufacturer's environmental requirements should be followed if they are more stringent than the UPS requirements. Operating temperatures above the recommended range will result in decreased battery life and performance, and may reduce or void the battery warranty.

The UPS ventilation requirements are shown in [Table 2](#).

To allow for future power upgrades, Eaton recommends using air conditioning or ventilation sized for the fully rated UPS kW frame size installed instead of the derated kW ordered. Sizing the site cooling infrastructure to be capable of cooling the maximum kW frame size will allow a full power rating upgrade without having to modify the infrastructure.

Table 2. Air Conditioning or Ventilation Requirements During Full Load Operation

Model	UPS Rating	Input/Output Voltage	Heat Rejection BTU/hr x1000 (kg-cal/hr)	Minimum Required Cooling Air Flow at Full Load
Eaton 93PM-150-1 Eaton 93PM-150-2 (N+1)	20 kW	480/480	2.55 (643)	
Eaton 93PM-150-1 Eaton 93PM-150-2 (N+1)	30 kW	480/480	3.58 (903)	556 liter/sec (1200 cfm)
Eaton 93PM-150-1 Eaton 93PM-150-2 (N+1)	40 kW	480/480	4.56 (1150)	
Eaton 93PM-150-1 Eaton 93PM-150-2 (N+1)	50 kW	480/480	5.70 (1438)	
Eaton 93PM-150-2 Eaton 93PM-150-3 (N+1)	60 kW	480/480	7.16 (1807)	556 liter/sec (1200 cfm)
Eaton 93PM-150-2 Eaton 93PM-150-3 (N+1)	70 kW	480/480	8.36 (2108)	

Table 2. Air Conditioning or Ventilation Requirements During Full Load Operation (Continued)

Model	UPS Rating	Input/Output Voltage	Heat Rejection BTU/hr x1000 (kg-cal/hr)	Minimum Required Cooling Air Flow at Full Load
Eaton 93PM-150-2 Eaton 93PM-150-3 (N+1)	80 kW	480/480	9.12 (2300)	556 liter/sec (1200 cfm)
Eaton 93PM-150-2 Eaton 93PM-150-3 (N+1)	90 kW	480/480	10.26 (2588)	
Eaton 93PM-150-2 Eaton 93PM-150-3 (N+1)	100 kW	480/480	11.40 (2875)	
Eaton 93PM-150-3	110 kW	480/480	12.54 (3163)	
Eaton 93PM-150-3	120 kW	480/480	13.68 (3450)	
Eaton 93PM-150-3	130 kW	480/480	14.82 (3738)	
Eaton 93PM-150-3	140 kW	480/480	15.96 (4025)	
Eaton 93PM-150-3	150 kW	480/480	17.10 (4313)	

The UPS equipment operating environment must meet the weight requirements shown in [Table 3](#) and the size requirements shown in [Figure 4](#) through [Figure 14](#). Dimensions are in millimeters (inches).

Table 3. UPS Cabinet Weights

Model	Weight kg (lb)		
	Shipping	Installed	Point Loading
Eaton 93PM-150-1	372 (819)	352 (776)	4 at 88 (194)
Eaton 93PM-150-2	435 (959)	415 (916)	4 at 104 (229)
Eaton 93PM-150-3	499 (1100)	479 (1057)	4 at 120 (295)
Eaton 93PM-150-1 with Top Entry Wiring Sidecar (no breakers)	477 (944)	427 (941)	8 at 54 (118)
Eaton 93PM-150-2 with Top Entry Wiring Sidecar (no breakers)	540 (1084)	490 (1081)	8 at 61 (135)
Eaton 93PM-150-3 with Top Entry Wiring Sidecar (no breakers)	604 (1238)	554 (1222)	8 at 69 (153)
Eaton 93PM-150-1 with Left or Right-Mounted 2-Breaker SIAC-B	553 (1217)	529 (1166)	8 at 66 (146)
Eaton 93PM-150-2 with Left or Right-Mounted 2-Breaker SIAC-B	616 (1357)	592 (1306)	8 at 74 (163)
Eaton 93PM-150-3 with Left or Right-Mounted 2-Breaker SIAC-B	680 (1498)	656 (1447)	8 at 82 (181)
Eaton 93PM-150-1 with Left or Right-Mounted 4-Breaker SIAC-B	566 (1247)	542 (1196)	8 at 68 (150)
Eaton 93PM-150-2 with Left or Right-Mounted 4-Breaker SIAC-B	630 (1387)	606 (1336)	8 at 76 (167)
Eaton 93PM-150-3 with Left or Right-Mounted 4-Breaker SIAC-B	694 (1527)	670 (1476)	8 at 84 (185)

**NOTE**

Refer to the *Eaton 93PM Sidecar Integrated Accessory Cabinet-Bypass Installation and Operation (150 kW and 200 kW SIAC-B) Manual*, listed in paragraph [1.8 For More Information](#), for Sidecar Integrated Accessory Cabinet-Bypass (SIAC-B) size requirements.

The UPS cabinet uses forced air cooling to regulate internal component temperature. Air inlets are in the front of the cabinet and outlets are on top or in the back of the cabinet. Allow clearance in front of and on top or in back of the cabinet for proper air circulation. The clearances required around the UPS cabinet are shown in [Table 4](#).

Table 4. UPS Cabinet Clearances

From Front of Cabinet	914.4 mm (36") working space
From Top of Cabinet with Top Exhaust (Zones 1 and 3 – see Figure 5)	457.2 mm (18") minimum clearance for ventilation
From Top of Cabinet (Zones 2 and 3– see Figure 5)	457.2 mm (18") working space
From Top of Cabinet with rear service access (Zone 2– see Figure 5)	Can be less than 457.2 mm (18")
From Back of Cabinet with Rear Exhaust	457.2 mm (18") minimum clearance for ventilation
From Back of Cabinet with Top Exhaust	None Required
From Back of Cabinet – Seismic Installation	914.4 mm (36") working space
From Right Side of Cabinet	None Required
From Left Side of Cabinet	None Required

Figure 4. UPS Cabinet Dimensions (Front and Right Side Views)

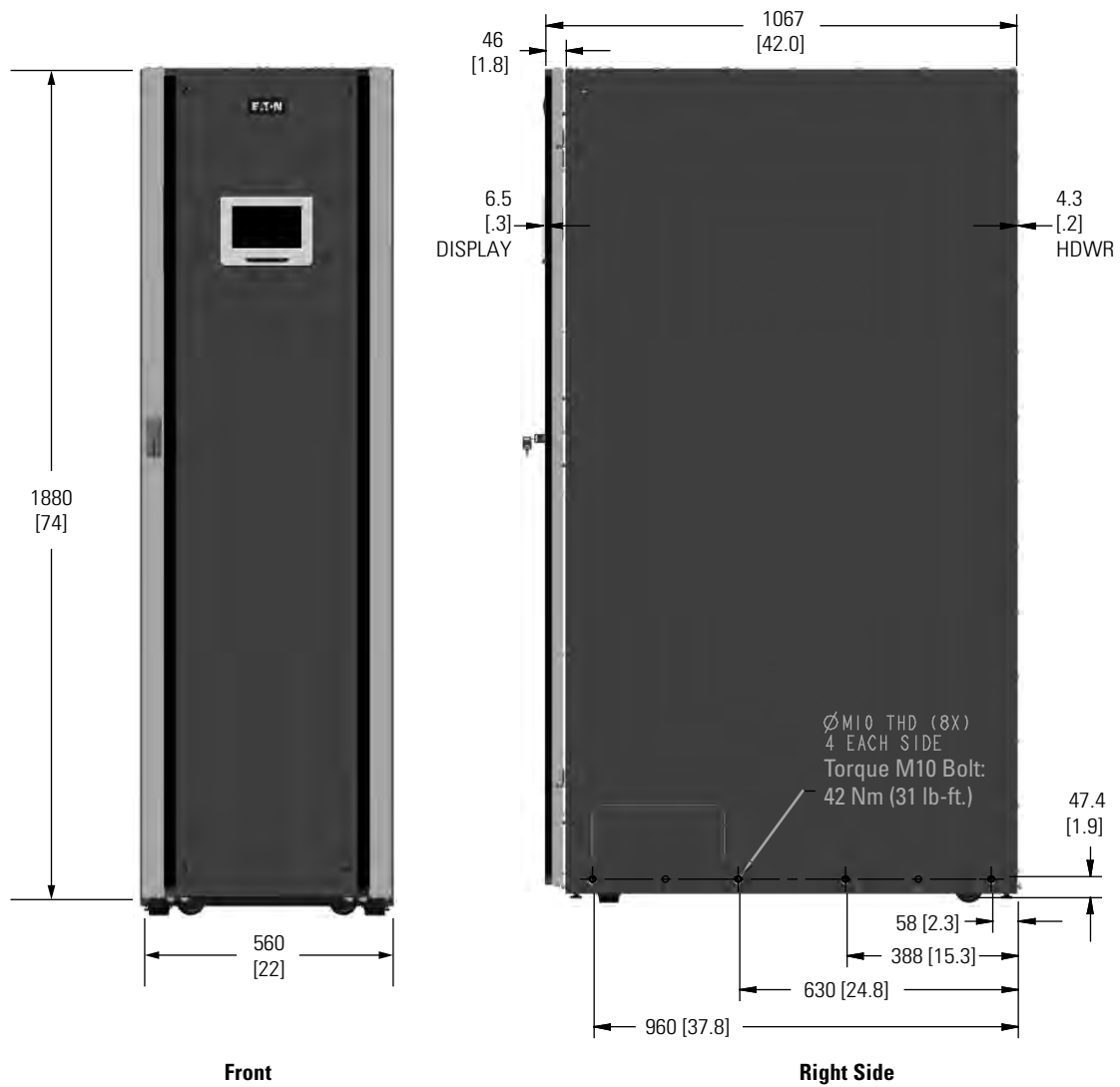
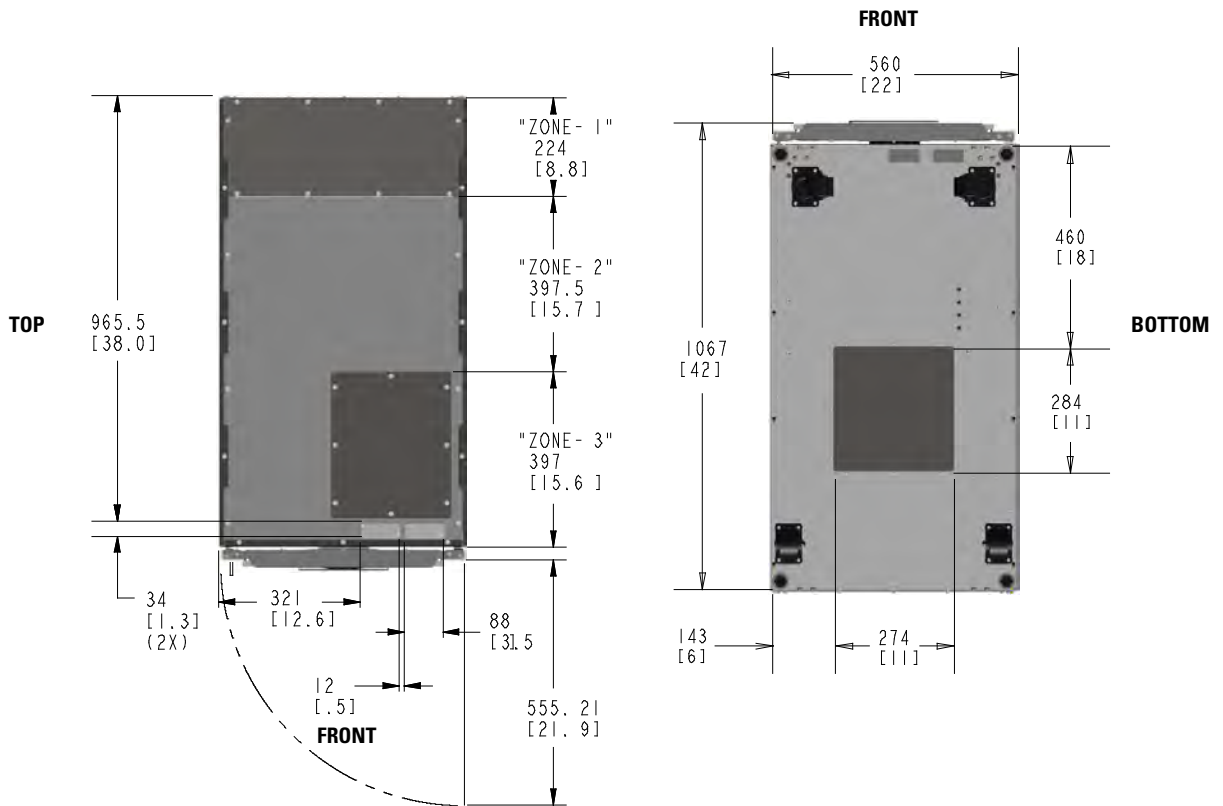

Figure 5. UPS Cabinet Dimensions (Top and Bottom Views)



NOTE: Rear exhaust configuration shown.

Dimensions are in millimeters [inches]

Figure 6. UPS Cabinet with Left or Right-Mounted Sidecar Dimensions (Front Views)



**Front
UPS With Left-Mounted Sidecar**

**Front
UPS With Right-Mounted Sidecar**

Dimensions are in millimeterse [Inches]

Figure 7. UPS Cabinet with Left or Right-Mounted Sidecar Dimensions (Top and Bottom Views)

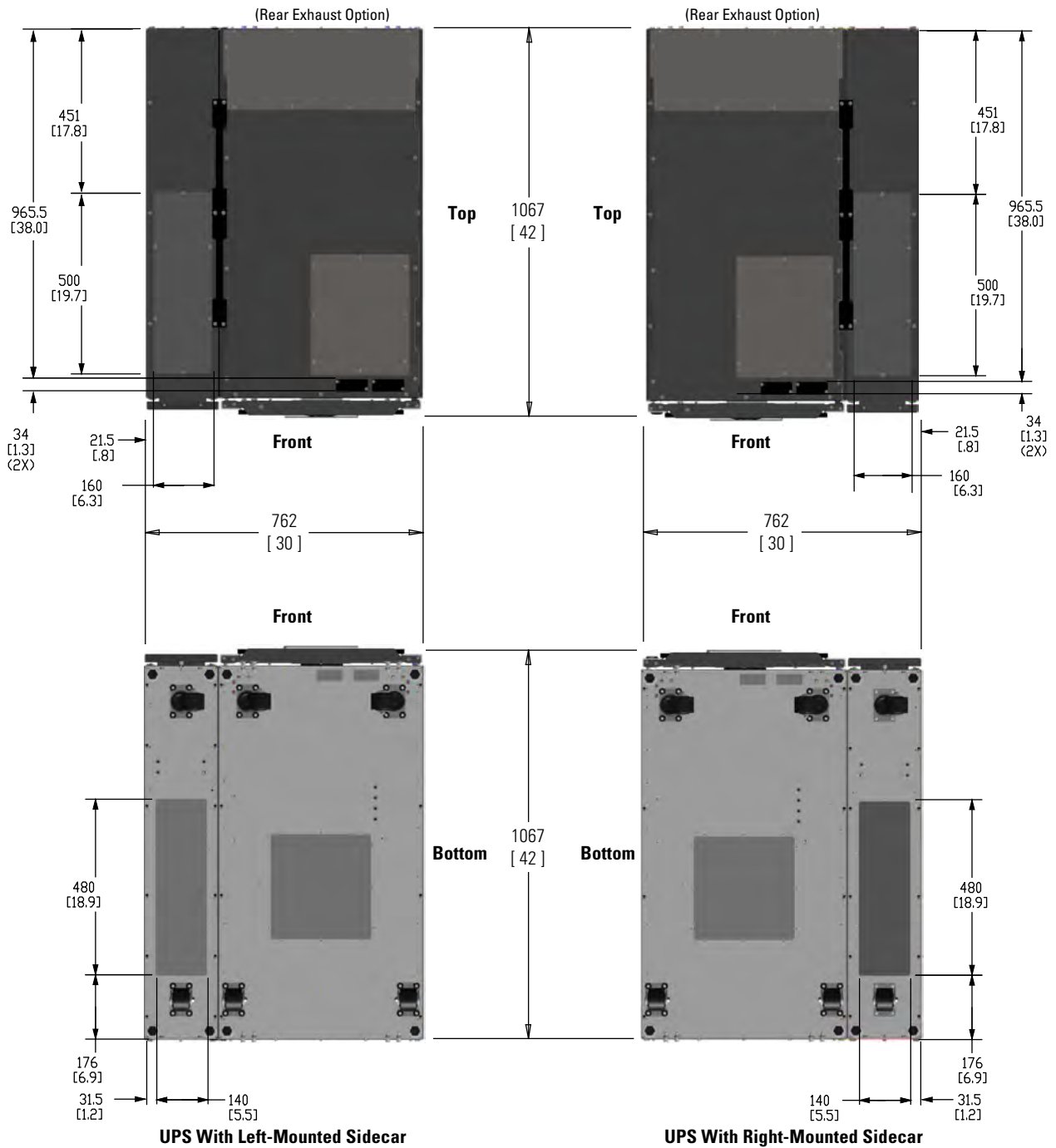

Dimensions are in millimeters [Inches]

Figure 8. UPS Cabinet with Left or Right-Mounted SIAC-B Dimensions (Front Views)

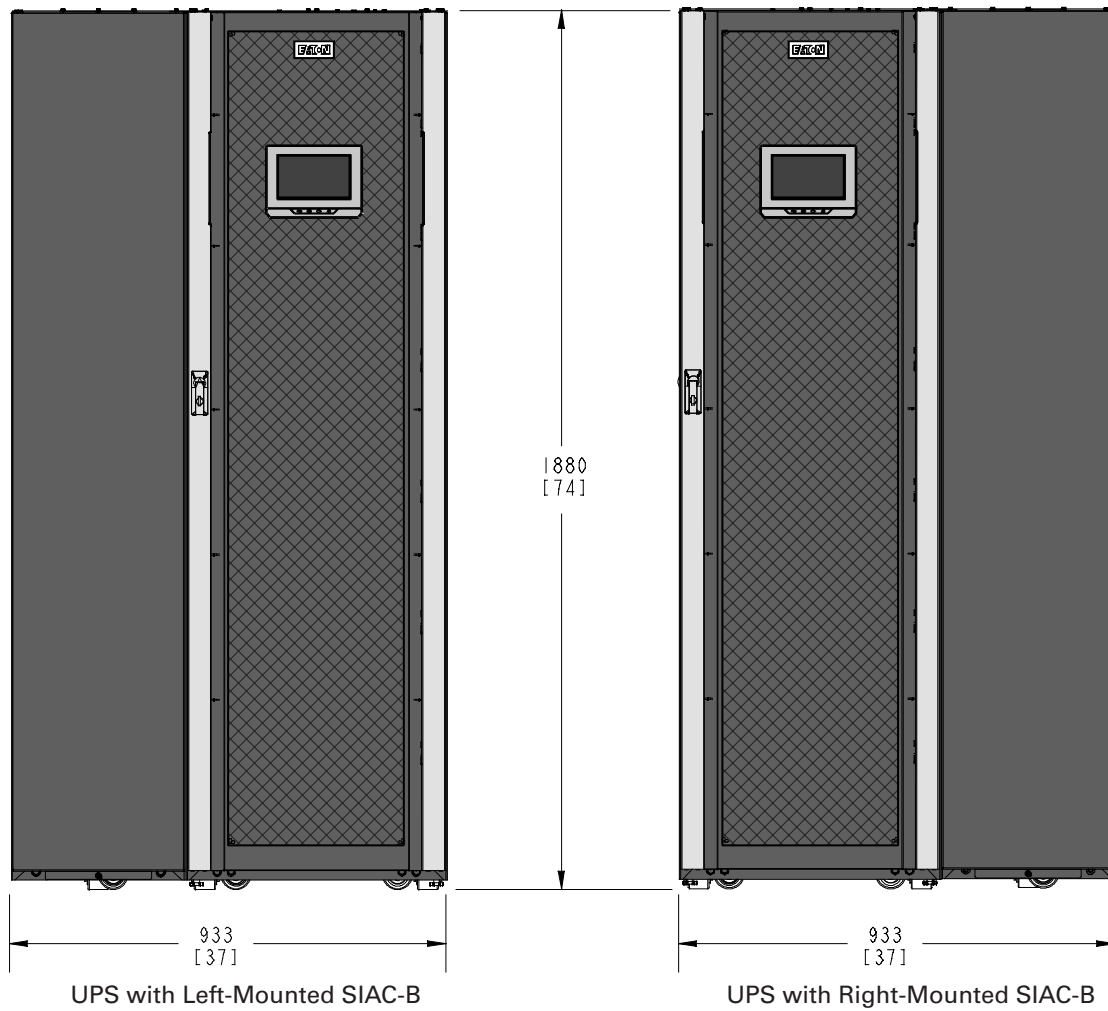

Dimensions are in millimeters [inches]

Figure 9. UPS Cabinet with Left or Right-Mounted SIAC-B Dimensions (Top and Bottom Views)

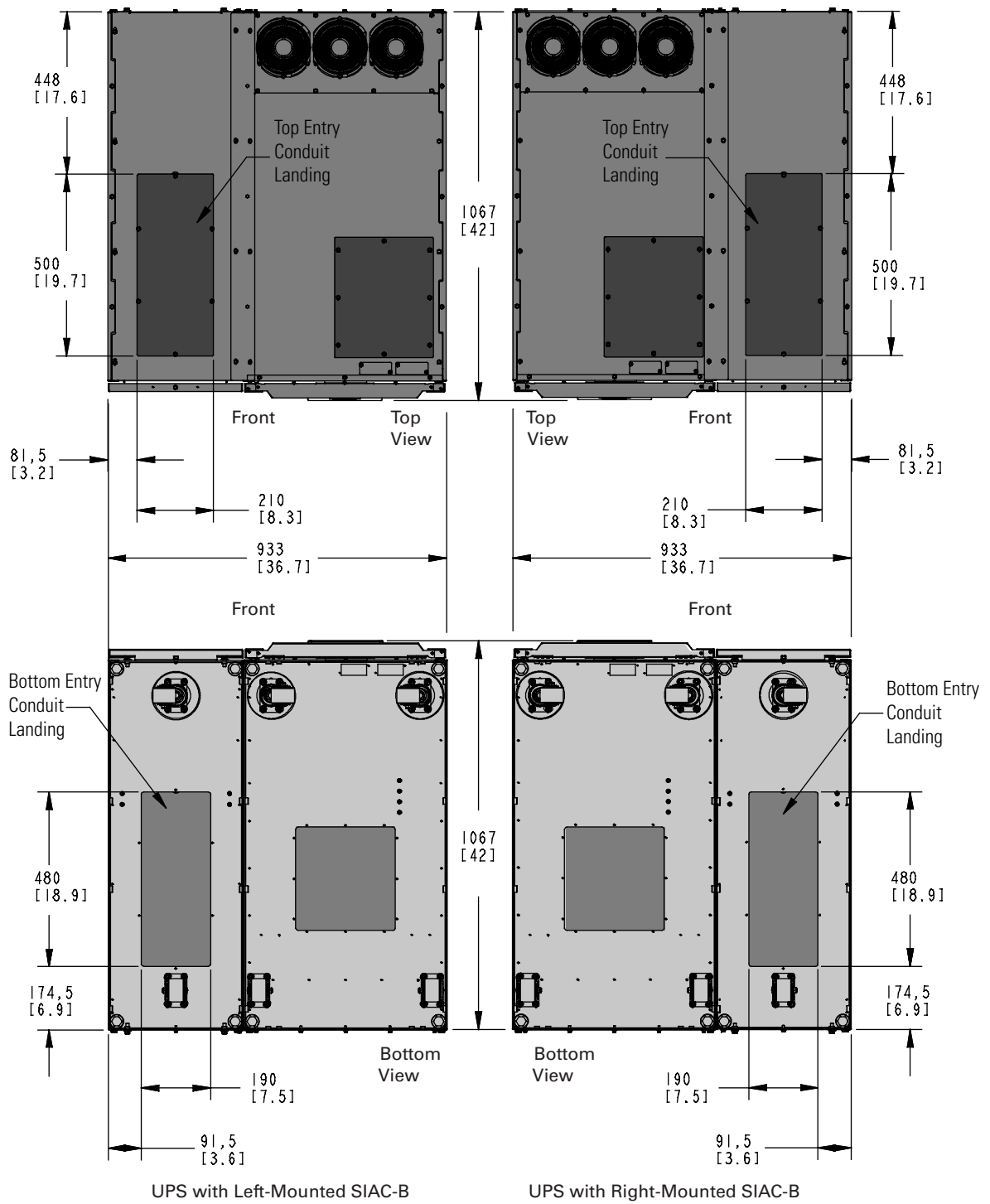

UPS with Left-Mounted SIAC-B

UPS with Right-Mounted SIAC-B

Dimensions are in millimeters [inches]

Figure 10. UPS Cabinet Front and Back Floor Mounting Bracket Mounting Dimensions (Back Views)

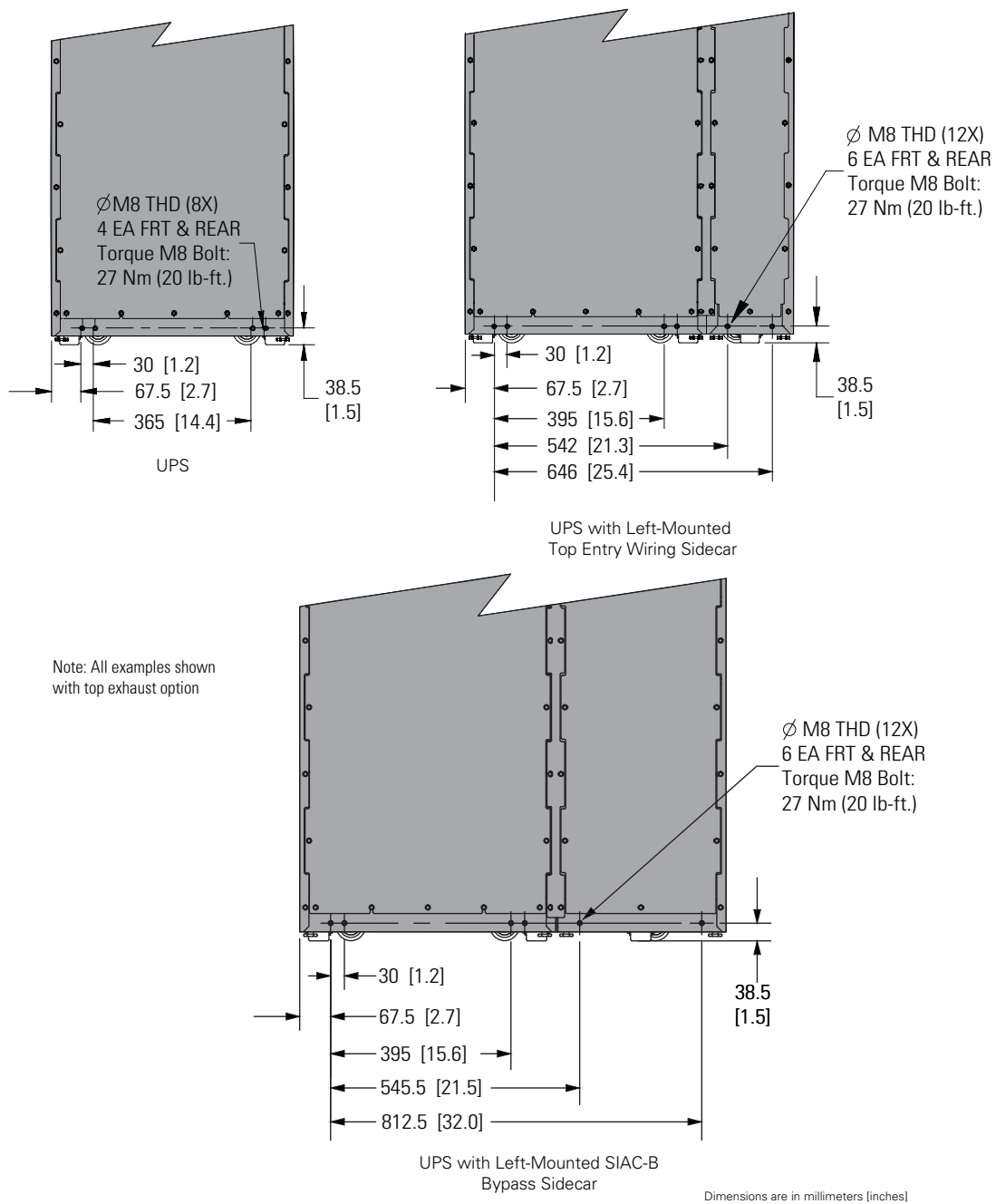

NOTE

The UPS Front Floor Mounting Bracket's mounting dimensions are identical to the Rear Floor Mounting Bracket dimensions.

Figure 11. UPS Cabinet Center of Gravity

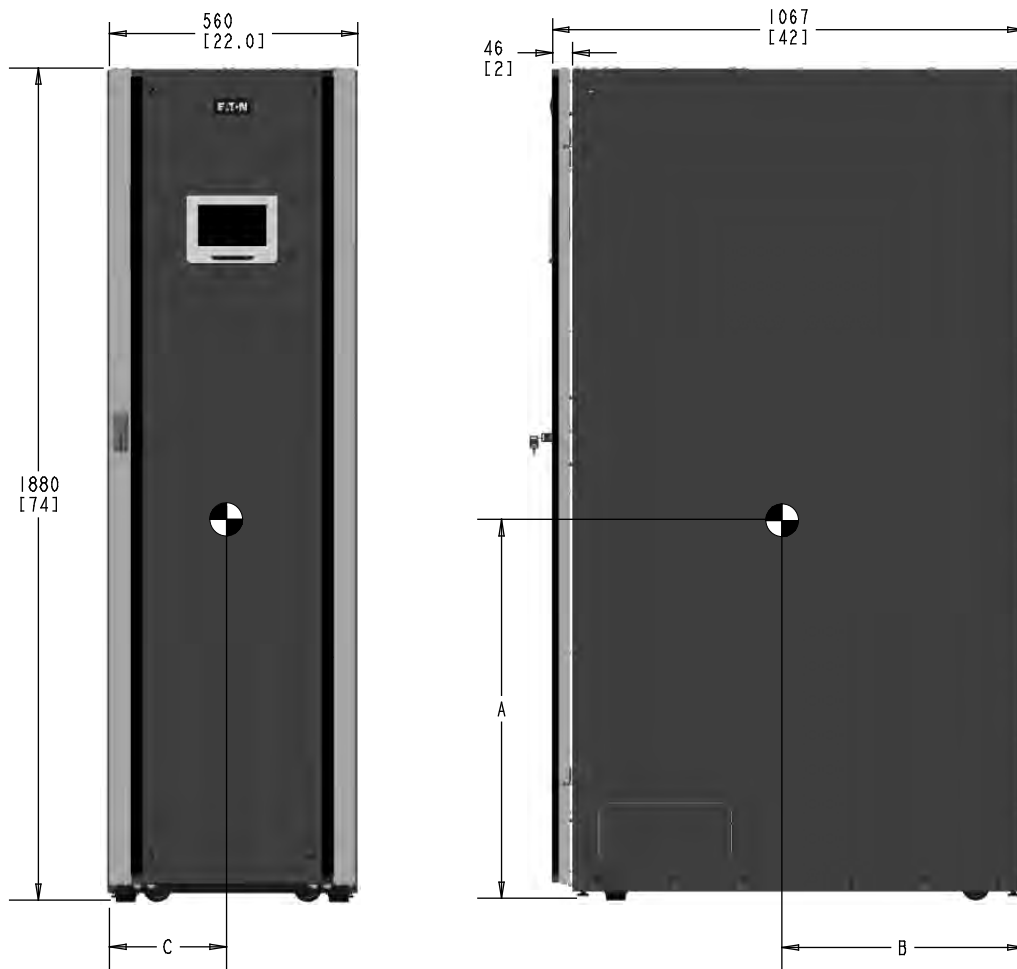

Dimensions are in millimeters [Inches]

Weight and Center of Gravity (letters A, B, and C map to Figure 11)				
	A	B	C	Weight
	mm (in)	mm (in)	mm (in)	kg (lb)
Eaton 93PM-150 UPS with 1 UPM Installed	824 (32.4)	528 (20.8)	282 (11.1)	372 (820)
Eaton 93PM-150 UPS with 2 UPMs Installed	900 (35.4)	528 (20.8)	282 (11.1)	435 (960)
Eaton 93PM-150 UPS with 3 UPMs Installed	998 (39.3)	528 (20.8)	282 (11.1)	499 (1101)

Figure 12. UPS Cabinet with Left or Right-Mounted Top Entry Wiring Sidecar Center of Gravity

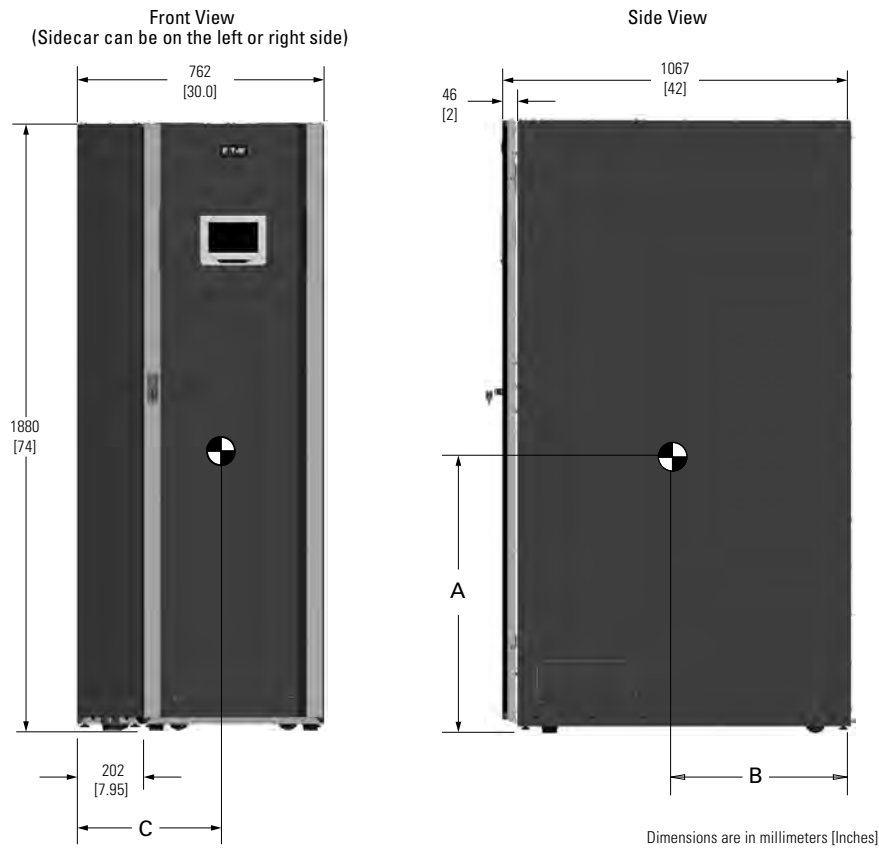

Weight and Center of Gravity with Top Entry Wiring Sidecar (letters A, B, and C map to Figure 12)		A	B	C	Installed Weight
		mm (in)	mm (in)	mm (in)	kg (lb)
UPS with Left-Mounted Empty Sidecar (Top Entry)	Eaton 93PM-150 UPS with 1 UPM Installed	829 (32.7)	534 (21.0)	420 (16.5)	434 (957)
	Eaton 93PM-150 UPS with 2 UPMs Installed	894 (35.2)	534 (21.0)	428 (16.8)	498 (1097)
	Eaton 93PM-150 UPS with 3 UPMs Installed	979 (38.6)	534 (21.0)	434 (17.1)	562 (1238)
UPS with Right-Mounted Empty Sidecar (Top Entry)	Eaton 93PM-150 UPS with 1 UPM Installed	829 (32.7)	534 (21.0)	347 (13.7)	434 (957)
	Eaton 93PM-150 UPS with 2 UPMs Installed	894 (35.2)	534 (21.0)	339 (13.3)	498 (1097)
	Eaton 93PM-150 UPS with 3 UPMs Installed	979 (38.6)	534 (21.0)	332 (13.1)	562 (1238)

Figure 13. UPS Cabinet with Left or Right-Mounted SIAC-B Center of Gravity

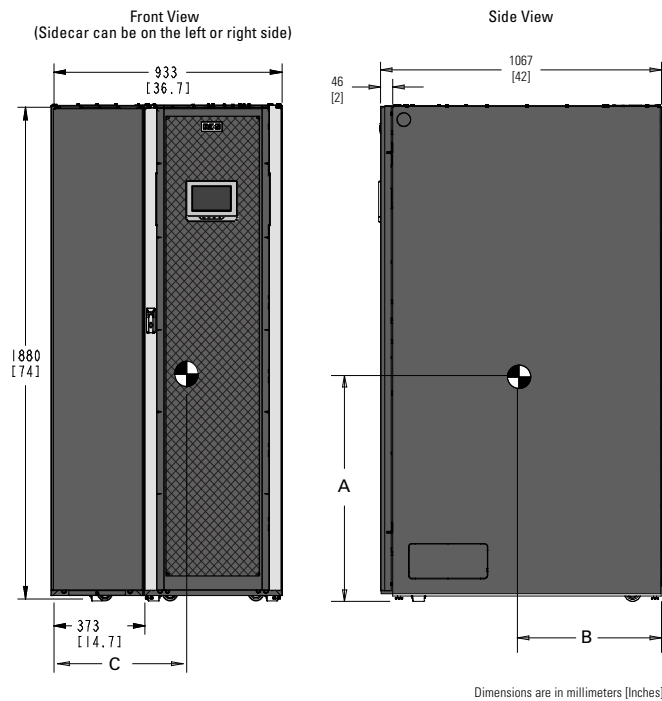

Weight and Center of Gravity with Left-Mounted SIAC-B (letters A, B, and C map to Figure 13)	A mm (in)	B mm (in)	C mm (in)	Installed Weight kg (lb)
Eaton 93PM-150-1 UPS with 2-Breaker SIAC-B	862 (33.9)	508 (20.0)	501 (19.7)	529 (1166)
Eaton 93PM-150-2 UPS with 2-Breaker SIAC-B	913 (35.9)	510 (20.1)	518 (20.4)	592 (1306)
Eaton 93PM-150-3 UPS with 2-Breaker SIAC-B	985 (38.8)	512 (20.2)	531 (20.9)	656 (1447)
Eaton 93PM-150-1 UPS with 4-breaker SIAC-B	870 (34.3)	507 (20.0)	494 (19.4)	542 (1196)
Eaton 93PM-150-2 UPS with 4-breaker SIAC-B	919 (36.2)	509 (20.0)	510 (20.1)	606 (1336)
Eaton 93PM-150-3 UPS with 4-breaker SIAC-B	989 (38.9)	511 (20.1)	524 (20.6)	670 (1476)

Weight and Center of Gravity with Right-Mounted SIAC-B (letters A, B, and C map to Figure 13)	A mm (in)	B mm (in)	C mm (in)	Installed Weight kg (lb)
Eaton 93PM-150-1 UPS with 2-Breaker SIAC-B	862 (33.9)	508 (20.0)	437 (17.2)	529 (1166)
Eaton 93PM-150-2 UPS with 2-Breaker SIAC-B	913 (35.9)	510 (20.1)	420 (16.5)	592 (1306)
Eaton 93PM-150-3 UPS with 2-Breaker SIAC-B	985 (38.8)	512 (20.2)	407 (16.0)	656 (1447)
Eaton 93PM-150-1 UPS with 4-breaker SIAC-B	870 (34.3)	507 (20.0)	445 (17.5)	542 (1196)
Eaton 93PM-150-2 UPS with 4-breaker SIAC-B	919 (36.2)	509 (20.0)	428 (16.9)	606 (1336)
Eaton 93PM-150-3 UPS with 4-breaker SIAC-B	989 (38.9)	511 (20.1)	414 (16.3)	670 (1476)

Figure 14. Remote EPO Switch Dimensions

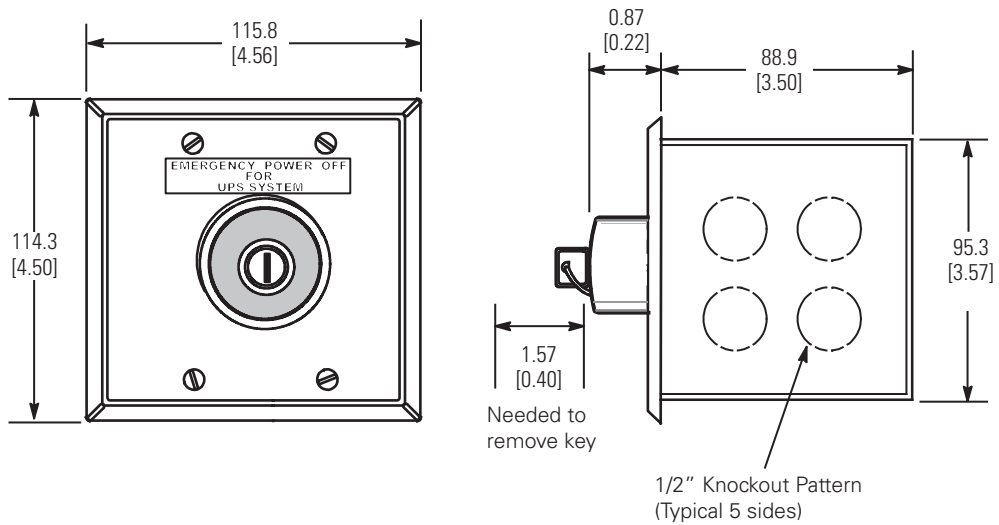

Dimensions are in millimeters (inches)

3.2.2 UPS System Power Wiring Preparation



NOTE

Refer to the *Eaton 93PM Sidecar Integrated Accessory Cabinet-Bypass Installation and Operation (150 kW and 200 kW SIAC-B) Manual*, listed in paragraph [1.8 For More Information](#), for SIAC-B power wiring preparation and requirements.

Read and understand the following notes while planning and performing the installation:

WARNING

As a result of the connected loads high leakage current is possible. Connection to earth ground is required for safety and proper product operation. Do not check UPS operation by any action that includes removal of the earth (ground) connection with loads attached.

- Refer to national and local electrical codes for acceptable external wiring practices.
- To allow for future power upgrades, Eaton recommends installing the UPS using wiring and external overcurrent protection breakers sized for the fully rated UPS kW frame size installed instead of the derated kW ordered. Wiring for the maximum kW frame size will allow a full power rating upgrade without having to modify the site wiring infrastructure.
- For external wiring, use 75°C copper wire.



IMPORTANT

This product has been evaluated for use with **copper wire only**.

Wire sizes listed in [Table 5](#), [Table 6](#), or [Table 7](#) are for copper wiring only. If wire is run in an ambient temperature greater than 40°C, larger size wire may be necessary. Wire sizes are based on using the specified breakers.

- The AC output and output ground wiring to the critical load should be sized the same as the UPS rectifier, bypass, and rectifier and bypass ground wiring if the recommended output breaker listed in [Table 11](#) is not installed in the system.
- Recommended wire sizes are based on NFPA National Electrical Code® (NEC®)70 Table 310.15(B)(16) 75°C ampacity with 40°C ambient correction factors.
- Connect to a 3 wire, grounded Wye source or in single source applications, a 3-wire High Resistance Ground (HRG) source. A neutral conductor is not used from the source or supplied to the load.
- Supported single source, single or dual feed power sources:
 - 3-wire grounded Wye (TN, TT)
 - 3-wire High Resistance Ground (IT)
- Supported dual source, dual feed power sources:
 - 3-wire grounded Wye (TN, TT)

CAUTION

SINGLE HIGH IMPEDANCE GROUND SOURCE – In North American installations, the neutral conductor from the high impedance ground source of supply CANNOT be used.

- Phase rotation must be clockwise starting with phase A (rotation A, B, C).
- If installing an external maintenance bypass, all feeds to the UPS including the Rectifier Input Breaker (RIB) (if installed) must have a service disconnect independent of the maintenance bypass power path. Most maintenance bypass solutions provide UPS input feeds derived from but isolated from the maintenance bypass power path. If the maintenance bypass solution being installed does not provide such functionality, DO NOT use a single feeder breaker to supply both the UPS and the maintenance bypass.

3.2.3 External Parallel UPS System Power Wiring Preparation

Read and understand the following notes in addition to the notes in paragraph [3.2.2 UPS System Power Wiring Preparation](#) while planning and performing the external parallel installation:

- All external parallel UPS rectifier inputs must come from one source and all bypass input feeds must come from one source.
- All UPSs in the external parallel system must contain the same number of UPMs. Mixed UPS kVA ratings are not permitted.
- External parallel UPS input wiring size recommendations and output wiring size recommendations from the UPSs to the tie cabinet are the same as listed in [Table 5](#), [Table 6](#), or [Table 7](#).
- The tie cabinet must contain Module Output Breakers (MOBs) with dual auxiliary contacts for control of the system. Without dual auxiliary MOBs, UPMs are not allowed to go to bypass individually during servicing. All UPMs will go to bypass instead of the UPM needing service, decreasing critical load protection.
- External parallel system wiring length should be in accordance with [Figure 15](#), to ensure approximately equal current sharing when in bypass mode.

Figure 15. 93PM External Parallel Wire Length

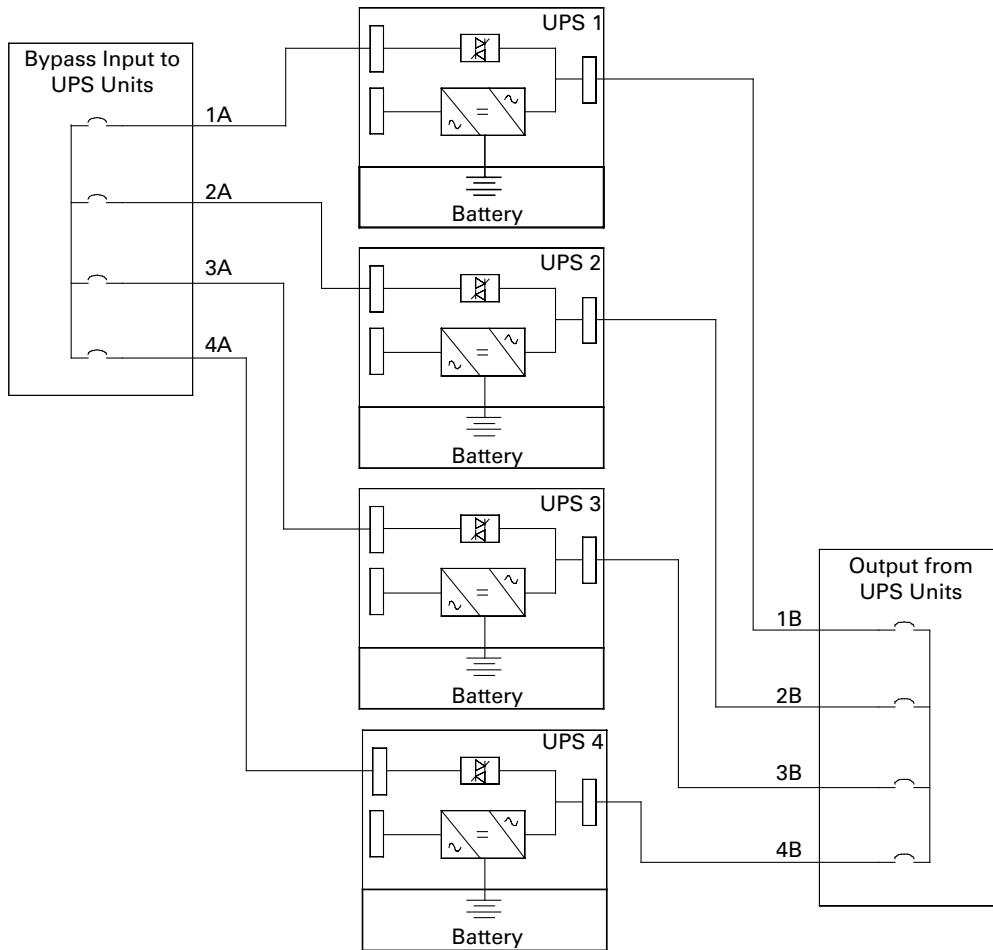

NOTE 1 Required parallel system wire length must be equal to ensure approximately equal current sharing when in Bypass mode. For proper operation the following must be true:
 $1A + 1B = 2A + 2B = 3A + 3B = 4A + 4B$



NOTE 2 Any difference in wire length will result in decreased capacity of the UPS system while on bypass. For example, a 10% difference between the longest and shortest wire lengths will result in a decrease in bypass capacity of 10%.

For external wiring recommendations, including the minimum AWG size of external wiring, see [Table 5](#), [Table 6](#), or [Table 7](#). Wire sizes listed are for copper wiring only.

Table 5. Input/Output Ratings and Wiring Recommendations: Eaton 93PM-150-1 and 93PM-150-2 (N+1)

Basic Unit Rating	Units		Rating 50/60 Hz			
	kW	20	30	40	50	
Input and Output Voltage	Volts	480/480	480/480	480/480	480/480	
AC Input to UPS Rectifier (0.99 Minimum pf) Full load current plus battery recharge current (3) Phases, (1) Ground	Amps	35	48	60	73	
Minimum Conductor Size (Phase A, B, and C) Number per Phase	A	AWG or kcmil (each)	8 (1)	6 (1)	4 (1)	3 (1)
	–	AWG or kcmil (each)	10 (1)	10 (1)	8 (1)	8 (1)
Minimum Conductor Size (Ground) Number	–	AWG or kcmil (each)	10 (1)	10 (1)	8 (1)	8 (1)
AC Input to UPS Bypass (Three-Wire, Dual-Feed) Full Load Current: (3) Phases, (1) Ground	Amps	35	48	60	73	
Minimum Conductor Size (Phase A, B, and C) Number per Phase	B	AWG or kcmil (each)	8 (1)	6 (1)	4 (1)	3 (1)
	–	AWG or kcmil (each)	10 (1)	10 (1)	8 (1)	8 (1)
Minimum Conductor Size (Ground) Number	–	AWG or kcmil (each)	10 (1)	10 (1)	8 (1)	8 (1)
DC Input from External Battery (Line-Up-and-Match Eaton 93PM IBC) (1) Positive, (1) Negative, (1) Ground	Total Amps (216 cell)	50	74	99	124	
Minimum Conductor Size (Phase Positive and Negative) Number per Pole	C	Total Amps (240 cell)	45	67	89	111
	AWG or kcmil (each)	2/0 (1)	2/0 (1)	2/0 (1)	2/0 (1)	
Minimum Conductor Size (Ground) Number	–	See Note	See Note	See Note	See Note	
	AWG or kcmil (each)	4 (1)	4 (1)	4 (1)	4 (1)	
DC Input from External Battery (Standalone Eaton 93PM IBC) (1) Positive, (1) Negative, (1) Ground	Total Amps (216 cell)	50	74	99	124	
Minimum Conductor Size (Phase Positive and Negative) Number per Pole	C	Total Amps (240 cell)	45	67	89	111
	AWG or kcmil (each)	3/0 (2)	3/0 (2)	3/0 (2)	3/0 (2)	
Minimum Conductor Size (Ground) Number	–	AWG or kcmil (each)	4 (1)	4 (1)	4 (1)	4 (1)
AC Output to Critical Load or IAC-T (Three-Wire) Full Load Current: (3) Phases, (1) Ground	Amps	24	36	48	60	
Minimum Conductor Size (Phase A, B, and C) Number per Phase	D	AWG or kcmil (each)	10 (1)	8 (1)	6 (1)	4 (1)

Table 5. Input/Output Ratings and Wiring Recommendations: Eaton 93PM-150-1 and 93PM-150-2 (N+1) (Continued)

Minimum Conductor Size (Ground) Number	–	AWG or kcmil (each)	10 (1)	10 (1)	10 (1)	8 (1)
NOTE Callout letters A, B, C and D map to the Oneline Schematics detailed in Chapter 6 UPS Oneline Schematics .						
NOTE Line-up-and-match battery wiring with a 105°C rating is factory supplied with the Eaton 93PM Integrated Battery Cabinet (IBC).						

Table 6. Input/Output Ratings and Wiring Recommendations: Eaton 93PM-150-2 and 93PM-150-3 (N+1)

Basic Unit Rating	Units		Rating 50/60 Hz				
	kW		60	70	80	90	100
Input and Output Voltage	Volts		480/ 480	480/ 480	480/ 480	480/ 480	480/ 480
AC Input to UPS Rectifier (0.99 Minimum pF) Full load current plus battery recharge current (3) Phases, (1) Ground	Amps		94	108	120	133	146
Minimum Conductor Size (Phase A, B, and C) Number per Phase	A	AWG or kcmil	1	1/0	2/0	2/0	3/0
		(each)	(1)	(1)	(1)	(1)	(1)
Minimum Conductor Size (Ground) Number	–	AWG or kcmil	6	6	6	6	6
		(each)	(1)	(1)	(1)	(1)	(1)
AC Input to UPS Bypass (Three-Wire, Dual-Feed) Full Load Current: (3) Phases, (1) Ground	B	Amps	94	108	120	133	146
Minimum Conductor Size (Phase A, B, and C) Number per Phase	B	AWG or kcmil	1	1/0	2/0	2/0	3/0
		(each)	(1)	(1)	(1)	(1)	(1)
Minimum Conductor Size (Ground) Number	–	AWG or kcmil	6	6	6	6	6
		(each)	(1)	(1)	(1)	(1)	(1)
DC Input from External Battery (Line-Up-and-Match Eaton 93PM IBC) (1) Positive, (1) Negative, (1) Ground	C	Total Amps (216 cell)	149	165	198	223	247
		Total Amps (240 cell)	134	158	178	200	223
Minimum Conductor Size (Phase Positive and Negative) Number per Pole	C	AWG or kcmil	2/0	2/0	2/0	2/0	2/0
		(each)	(1)	(1)	(1)	(1)	(1)
			See Note	See Note	See Note	See Note	See Note
Minimum Conductor Size (Ground) Number	–	AWG or kcmil	4	4	4	4	4
		(each)	(1)	(1)	(1)	(1)	(1)
DC Input from External Battery (Standalone Eaton 93PM IBC) (1) Positive, (1) Negative, (1) Ground	C	Total Amps (216 cell)	149	165	198	223	247
		Total Amps (240 cell)	134	158	178	200	223

Table 6. Input/Output Ratings and Wiring Recommendations: Eaton 93PM-150-2 and 93PM-150-3 (N+1) (Continued)

Minimum Conductor Size (Phase Pos. and Neg.) Number per Pole	AWG or kcmil (each)	3/0 (2)	3/0 (2)	3/0 (2)	3/0 (2)	3/0 (2)
Minimum Conductor Size (Ground) Number	– AWG or kcmil (each)	4 (1)	4 (1)	4 (1)	4 (1)	4 (1)
AC Output to Critical Load or IAC-T (Three-Wire) Full Load Current: (3) Phases, (1) Ground	Amps	72	84	96	108	120
Minimum Conductor Size (Phase A, B, and C) Number per Phase	AWG or kcmil (each)	3 (1)	2 (1)	1 (1)	1/0 (1)	2/0 (1)
Minimum Conductor Size (Ground) Number	– AWG or kcmil (each)	8 (1)	6 (1)	6 (1)	6 (1)	6 (1)
NOTE Callout letters A , B , C and D map to the Oneline Schematics detailed in Chapter 6 UPS Oneline Schematics .						
NOTE Line-up-and-match battery wiring with a 105°C rating is factory supplied with the Eaton 93PM Integrated Battery Cabinet (IBC).						

Table 7. Input/Output Ratings and Wiring Recommendations: Eaton 93PM-150-3

Basic Unit Rating	Units	Rating 50/60 Hz				
	kW	110	120	130	140	150
Input and Output Voltage	Volts	480/ 480	480/ 480	480/ 480	480/ 480	480/ 480
AC Input to UPS Rectifier (0.99 Minimum pF) Full load current plus battery recharge current (3) Phases, (1) Ground	Amps	168	181	193	206	218
Minimum Conductor Size (Phase A, B, and C) Number per Phase	AWG or kcmil (each)	4/0 (1)	4/0 (1)	250 (1)	1 (2)	1/0 (2)
Minimum Conductor Size (Ground) Number	– AWG or kcmil (each)	4 (1)	4 (1)	4 (1)	6 (2)	6 (2)
AC Input to UPS Bypass (Three-Wire, Dual-Feed) Full Load Current: (3) Phases, (1) Ground	Amps	168	181	193	206	218
Minimum Conductor Size (Phase A, B, and C) Number per Phase	AWG or kcmil (each)	4/0 (1)	4/0 (1)	250 (1)	1 (2)	1/0 (2)
Minimum Conductor Size (Ground) Number	– AWG or kcmil (each)	4 (1)	4 (1)	4 (1)	6 (2)	6 (2)
DC Input from External Battery (Line-Up-and-Match Eaton 93PM IBC) (1) Positive, (1) Negative, (1) Ground	Total Amps (216 cell)	272	297	322	346	371
	C Total Amps (240 cell)	245	267	289	312	334

Table 7. Input/Output Ratings and Wiring Recommendations: Eaton 93PM-150-3 (Continued)

Minimum Conductor Size (Phase Positive and Negative) Number per Pole		AWG or kcmil (each)	2/0 (1) See Note	2/0 (1) See Note	2/0 (1) See Note	2/0 (1) See Note	2/0 (1) See Note
Minimum Conductor Size (Ground) Number	–	AWG or kcmil (each)	4 (1)	4 (1)	4 (1)	4 (1)	4 (1)
DC Input from External Battery (Standalone Eaton 93PM IBC) (1) Positive, (1) Negative, (1) Ground		Total Amps (216 cell) Total Amps (240 cell)	272 245	297 267	322 289	346 312	371 334
Minimum Conductor Size (Phase Positive and Negative) Number per Pole	C	AWG or kcmil (each)	300 (2)	300 (2)	300 (2)	300 (2)	300 (2)
Minimum Conductor Size (Ground) Number	–	AWG or kcmil (each)	1 (1)	1 (1)	1 (1)	1 (1)	1 (1)
AC Output to Critical Load (Three-Wire) Full Load Current: (3) Phases, (1) Ground		Amps	132	144	156	168	180
Minimum Conductor Size (Phase A, B, and C) Number per Phase	D	AWG or kcmil (each)	2/0 (1)	3/0 (1)	3/0 (1)	4/0 (1)	4/0 (1)
Minimum Conductor Size (Ground) Number	–	AWG or kcmil (each)	6 (1)	6 (1)	6 (1)	4 (1)	4 (1)
AC Output to IAC-T (Three-Wire) Full Load Current: (3) Phases, (1) Ground		Amps	132	144	156	168	180
Minimum Conductor Size (Phase A, B, and C) Number per Phase	D	AWG or kcmil (each)	2/0 (1)	3/0 (1)	3/0 (1)	4/0 (1)	4/0 (1)
Minimum Conductor Size (Ground) Number	–	AWG or kcmil (each)	6 (1)	6 (1)	6 (1)	4 (1)	4 (1)
NOTE Callout letters A , B , C and D map to the Online Schematics detailed in Chapter 6 UPS Online Schematics .							

The power wiring terminals are pressure terminations, UL and CSA rated. See [Table 8](#) for external power cable terminations.

[Figure 25](#) and [Figure 26](#) show the location of the UPS power cable terminals.

Table 8. UPS External Power Cable Terminations

Terminal Function	Terminal	Function	Number and Size of Pressure Termination AWG or kcmil	Tightening Torque Nm (lb in)	Screw Size and Type
AC Input to UPS Rectifier	E1	Phase A	2 - #6-250 kcmil	31 (275)	1/4" Hex
	E2	Phase B	2 - #6-250 kcmil	31 (275)	1/4" Hex
	E3	Phase C	2 - #6-250 kcmil	31 (275)	1/4" Hex
AC Input to Bypass	E6	Phase A	2 - #6-250 kcmil	31 (275)	1/4" Hex
	E7	Phase B	2 - #6-250 kcmil	31 (275)	1/4" Hex
	E8	Phase C	2 - #6-250 kcmil	31 (275)	1/4" Hex
AC Output to Critical Load	E9	Phase A	2 - #6-250 kcmil	31 (275)	1/4" Hex
	E10	Phase B	2 - #6-250 kcmil	31 (275)	1/4" Hex
	E11	Phase C	2 - #6-250 kcmil	31 (275)	1/4" Hex
DC Input from Battery	E4	Battery (+)	4 - #6-300 kcmil	31 (275)	1/4" Hex
	E5	Battery (-)	4 - #6-300 kcmil	31 (275)	1/4" Hex
Customer Ground	Ground	Ground	6 - #14-1/0	5.1 (45)	Slotted

NOTE Customer ground, sized in accordance with NEC Table 250.122, can be run in any conduit listed in [Table 9](#).

Conduit sizes were chosen from NEC Table 4, Electrical Metallic Tubing (EMT). See [Table 9](#) for conduit recommendations.

Per NEC article 300, 3(B), all three-phase conductors must be run in the same conduit. A ground wire must be run in the same conduit as the phase conductors.

When running parallel wires in multiple conduits a ground wire must be run in each conduit in accordance with NEC Table 250.122.

Conduit is sized to accommodate one ground conductor per conduit, sized in accordance with NEC Table 250.122.

Conduit sizes listed are for copper wiring only.



IMPORTANT

This product has been evaluated for use with **copper wire only**. For external wiring, use only 75°C copper wire.

Table 9. Power Cable Conduit Recommendations

UPS Model	UPS Rating	Voltage	Terminal	Number of Wires in Conduit	Minimum Conduit Trade Size (Inches)	Number of Conduits
Eaton 93PM-150-1 Eaton 93PM-150-2 (N+1)	20 kW	480 Vac	AC Input to UPS Rectifier and Bypass (A, B, C, Ground)	4	3/4	1
			AC Output (Three-Wire) (A, B, C, Ground)	4	1/2	1
		DC	Battery (Positive, Negative, Ground)	5	2-1/2	1
Eaton 93PM-150-1 Eaton 93PM-150-2 (N+1)	30 kW	480 Vac	AC Input to UPS Rectifier and Bypass (A, B, C, Ground)	4	1	1
			AC Output (Three-Wire) (A, B, C, Ground)	4	3/4	1
		DC	Battery (Positive, Negative, Ground)	5	2-1/2	1
Eaton 93PM-150-1 Eaton 93PM-150-2 (N+1)	40 kW	480 Vac	AC Input to UPS Rectifier and Bypass (A, B, C, Ground)	4	1	1
			AC Output (Three-Wire) (A, B, C, Ground)	4	1	1
		DC	Battery (Positive, Negative, Ground)	5	2-1/2	1
Eaton 93PM-150-1 Eaton 93PM-150-2 (N+1)	50 kW	480 Vac	AC Input to UPS Rectifier and Bypass (A, B, C, Ground)	4	1-1/4	1
			AC Output (Three-Wire) (A, B, C, Ground)	4	1	1
		DC	Battery (Positive, Negative, Ground)	5	2-1/2	1
Eaton 93PM-150-2 Eaton 93PM-150-3 (N+1)	60 kW	480 Vac	AC Input to UPS Rectifier and Bypass (A, B, C, Ground)	4	1-1/2	1
			AC Output (Three-Wire) (A, B, C, Ground)	4	1-1/4	1
		DC	Battery (Positive, Negative, Ground)	5	2-1/2	1

Table 9. Power Cable Conduit Recommendations (Continued)

UPS Model	UPS Rating	Voltage	Terminal	Number of Wires in Conduit	Minimum Conduit Trade Size (Inches)	Number of Conduits
Eaton 93PM-150-2 Eaton 93PM-150-3 (N+1)	70 kW	480 Vac	AC Input to UPS Rectifier and Bypass (A, B, C, Ground)	4	1-1/2	1
			AC Output (Three-Wire) (A, B, C, Ground)	4	1-1/2	1
		DC	Battery (Positive, Negative, Ground)	5	2-1/2	1
Eaton 93PM-150-2 Eaton 93PM-150-3 (N+1)	80 kW	480 Vac	AC Input to UPS Rectifier and Bypass (A, B, C, Ground)	4	2	1
			AC Output (Three-Wire) (A, B, C, Ground)	4	1-1/2	1
		DC	Battery (Positive, Negative, Ground)	5	2-1/2	1
Eaton 93PM-150-2 Eaton 93PM-150-3 (N+1)	90 kW	480 Vac	AC Input to UPS Rectifier and Bypass (A, B, C, Ground)	4	2	1
			AC Output (Three-Wire) (A, B, C, Ground)	4	1-1/2	1
		DC	Battery (Positive, Negative, Ground)	5	2-1/2	1
Eaton 93PM-150-2 Eaton 93PM-150-3 (N+1)	100 kW	480 Vac	AC Input to UPS Rectifier and Bypass (A, B, C, Ground)	4	2	1
			AC Output (Three-Wire) (A, B, C, Ground)	4	2	1
		DC	Battery (Positive, Negative, Ground)	5	2-1/2	1
Eaton 93PM-150-3	110 kW	480 Vac	AC Input to UPS Rectifier and Bypass (A, B, C, Ground)	4	2	1
			AC Output (Three-Wire) (A, B, C, Ground)	4	2	1
		DC	Battery (Positive, Negative, Ground)	3	2	2

Table 9. Power Cable Conduit Recommendations (Continued)

UPS Model	UPS Rating	Voltage	Terminal	Number of Wires in Conduit	Minimum Conduit Trade Size (Inches)	Number of Conduits
Eaton 93PM-150-3	120 kW	480 Vac	AC Input to UPS Rectifier and Bypass (A, B, C, Ground)	4	2	1
			AC Output (Three-Wire) (A, B, C, Ground)	4	2	1
		DC	Battery (Positive, Negative, Ground)	3	2	2
Eaton 93PM-150-3	130 kW	480 Vac	AC Input to UPS Rectifier and Bypass (A, B, C, Ground)	4	2-1/2	1
			AC Output (Three-Wire) (A, B, C, Ground)	4	2	1
		DC	Battery (Positive, Negative, Ground)	3	2	2
Eaton 93PM-150-3	140 kW	480 Vac	AC Input to UPS Rectifier and Bypass (A, B, C, Ground)	4	1-1/2	2
			AC Output (Three-Wire) (A, B, C, Ground)	4	2	1
		DC	Battery (Positive, Negative, Ground)	3	2	2
Eaton 93PM-150-3	150 kW	480 Vac	AC Input to UPS Rectifier and Bypass (A, B, C, Ground)	4	1-1/2	2
			AC Output (Three-Wire) (A, B, C, Ground)	4	2	1
		DC	Battery (Positive, Negative, Ground)	3	2	2

NOTE Wires per conduit includes ground wire.

External overcurrent protection and disconnect are not provided by this product, but are required by codes. See [Table 5](#), [Table 6](#), or [Table 7](#) for wiring recommendations. If an output lockable disconnect is required, it is to be supplied by the customer.

[Table 10](#) lists the recommended rating for input and bypass circuit breakers.

Table 10. Recommended Input and Bypass Circuit Breaker Ratings

UPS Model	UPS Rating	Input Rating	
		Load Rating	480V
Eaton 93PM-150-1	20 kW	80% Rated	45A
Eaton 93PM-150-2 (N+1)		100% Rated	35A
Eaton 93PM-150-1	30 kW	80% Rated	60A
Eaton 93PM-150-2 (N+1)		100% Rated	50A
Eaton 93PM-150-1	40 kW	80% Rated	80A
Eaton 93PM-150-2 (N+1)		100% Rated	60A
Eaton 93PM-150-1	50 kW	80% Rated	100A
Eaton 93PM-150-2 (N+1)		100% Rated	80A
Eaton 93PM-150-2	60 kW	80% Rated	125A
Eaton 93PM-150-3 (N+1)		100% Rated	100A
Eaton 93PM-150-2	70 kW	80% Rated	150A
Eaton 93PM-150-3 (N+1)		100% Rated	110A
Eaton 93PM-150-2	80 kW	80% Rated	150A
Eaton 93PM-150-3 (N+1)		100% Rated	125A
Eaton 93PM-150-2	90 kW	80% Rated	175A
Eaton 93PM-150-3 (N+1)		100% Rated	150A
Eaton 93PM-150-2	100 kW	80% Rated	200A
Eaton 93PM-150-3 (N+1)		100% Rated	150A
Eaton 93PM-150-3	110 kW	80% Rated	225A
		100% Rated	175A
Eaton 93PM-150-3	120 kW	80% Rated	250A
		100% Rated	200A
Eaton 93PM-150-3	130 kW	80% Rated	250A
		100% Rated	200A
Eaton 93PM-150-3	140 kW	80% Rated	300A
		100% Rated	225A
Eaton 93PM-150-3	150 kW	80% Rated	300A
		100% Rated	225A

CAUTION

To reduce the risk of fire, connect only to a circuit provided with maximum input circuit breaker current ratings from [Table 10](#) in accordance with the NEC, ANSI/NFPA 70.

The line-to-line unbalanced output capability of the UPS is limited only by the full load per phase current values for AC output to critical load shown in [Table 5](#), [Table 6](#), or [Table 7](#). The recommended line-to-line load unbalance is 50% or less.

Bypass and output overcurrent protection and bypass and output disconnect switches are to be supplied by the customer. [Table 11](#) lists the recommended rating for output circuit breakers.

Table 11. Recommended Output Circuit Breaker Ratings

UPS Model	UPS Rating	Output Rating	
		Load Rating	480V
Eaton 93PM-150-1	20 kW	80% Rated	30A
Eaton 93PM-150-2 (N+1)		100% Rated	25A
Eaton 93PM-150-1	30 kW	80% Rated	45A
Eaton 93PM-150-2 (N+1)		100% Rated	40A
Eaton 93PM-150-1	40 kW	80% Rated	60A
Eaton 93PM-150-2 (N+1)		100% Rated	50A
Eaton 93PM-150-1	50 kW	80% Rated	80A
Eaton 93PM-150-2 (N+1)		100% Rated	60A
Eaton 93PM-150-2	60 kW	80% Rated	90A
Eaton 93PM-150-3 (N+1)		100% Rated	80A
Eaton 93PM-150-2	70 kW	80% Rated	110A
Eaton 93PM-150-3 (N+1)		100% Rated	90A
Eaton 93PM-150-2	80 kW	80% Rated	125A
Eaton 93PM-150-3 (N+1)		100% Rated	100A
Eaton 93PM-150-2	90 kW	80% Rated	150A
Eaton 93PM-150-3 (N+1)		100% Rated	110A
Eaton 93PM-150-2	100 kW	80% Rated	150A
Eaton 93PM-150-3 (N+1)		100% Rated	125A
Eaton 93PM-150-3	110 kW	80% Rated	175A
		100% Rated	150A
Eaton 93PM-150-3	120 kW	80% Rated	200A
		100% Rated	150A
Eaton 93PM-150-3	130 kW	80% Rated	200A
		100% Rated	175A
Eaton 93PM-150-3	140 kW	80% Rated	225A
		100% Rated	175A
Eaton 93PM-150-3	150 kW	80% Rated	225A
		100% Rated	200A

There is no manual DC disconnect device within the UPS.

Battery voltage is computed at 2 volts per cell as defined by Article 480 of the NEC. Rated battery current is computed based on 2 volts per cell.

If required, external DC input overcurrent protection and disconnect switch is to be supplied by the customer. [Table 12](#) and [Table 13](#) list the recommended ratings for circuit breakers satisfying the criteria for each battery voltage. Recommended disconnect size is based on a maximum full load discharge time less than 3 hours. For longer discharge times a larger disconnect may be required.

Table 12. Recommended DC Input Battery Disconnect Circuit Breaker Ratings (216 Cell)

UPS Model	UPS Rating	Output Rating
		432V
Eaton 93PM-150-1 Eaton 93PM-150-2 (N+1)	20 kW	60A
Eaton 93PM-150-1 Eaton 93PM-150-2 (N+1)	30 kW	90A
Eaton 93PM-150-1 Eaton 93PM-150-2 (N+1)	40 kW	125A
Eaton 93PM-150-1 Eaton 93PM-150-2 (N+1)	50 kW	150A
Eaton 93PM-150-2 Eaton 93PM-150-3 (N+1)	60 kW	200A
Eaton 93PM-150-2 Eaton 93PM-150-3 (N+1)	70 kW	225A
Eaton 93PM-150-2 Eaton 93PM-150-3 (N+1)	80 kW	250A
Eaton 93PM-150-2 Eaton 93PM-150-3 (N+1)	90 kW	300A
Eaton 93PM-150-2 Eaton 93PM-150-3 (N+1)	100 kW	300A
Eaton 93PM-150-3	110 kW	350A
Eaton 93PM-150-3	120 kW	400A
Eaton 93PM-150-3	130 kW	400A
Eaton 93PM-150-3	140 kW	450A
Eaton 93PM-150-3	150 kW	450A

Table 13. Recommended DC Input Battery Disconnect Circuit Breaker Ratings (240 Cell)

UPS Model	UPS Rating	Output Rating
		480V
Eaton 93PM-150-1 Eaton 93PM-150-2 (N+1)	20 kW	60A
Eaton 93PM-150-1 Eaton 93PM-150-2 (N+1)	30 kW	90A
Eaton 93PM-150-1 Eaton 93PM-150-2 (N+1)	40 kW	125A
Eaton 93PM-150-1 Eaton 93PM-150-2 (N+1)	50 kW	150A
Eaton 93PM-150-2 Eaton 93PM-150-3 (N+1)	60 kW	175A
Eaton 93PM-150-2 Eaton 93PM-150-3 (N+1)	70 kW	200A
Eaton 93PM-150-2 Eaton 93PM-150-3 (N+1)	80 kW	225A
Eaton 93PM-150-2 Eaton 93PM-150-3 (N+1)	90 kW	250A
Eaton 93PM-150-2 Eaton 93PM-150-3 (N+1)	100 kW	300A
Eaton 93PM-150-3	110 kW	300A
Eaton 93PM-150-3	120 kW	350A
Eaton 93PM-150-3	130 kW	400A
Eaton 93PM-150-3	140 kW	400A
Eaton 93PM-150-3	150 kW	450A

3.2.4 UPS System Interface Wiring Preparation

NOTE

Refer to the *Eaton 93PM Sidecar Integrated Accessory Cabinet-Bypass Installation and Operation (150 kW and 200 kW SIAC-B) Manual*, listed in paragraph [1.8 For More Information](#), for SIAC-B interface wiring preparation and requirements.

Control wiring for features and options should be connected at the customer interface terminal blocks located inside the UPS.

WARNING

Do not directly connect relay contacts to the mains related circuits. Reinforced insulation to the mains is required.

Read and understand the following notes while planning and performing the installation:

- Use Class 1 wiring methods (as defined by the NEC) for interface wiring from 30V to 600V. The wire should be rated for 600V, 1A minimum. 12 AWG maximum wire size.
- Use Class 2 wiring methods (as defined by the NEC) for interface wiring up to 30V. The wire should be rated for 24V, 1A minimum.
- Because of the battery shunt trip wiring route in the UPS cabinet, the wire should be rated for a minimum of 600V.
- Use twisted-pair wires for each input and return or common.
- All interface wiring and conduit is to be supplied by the customer.
- When installing external interface wiring between a building alarm, relay output, battery breaker trip, or Minislot and the UPS interface terminals, conduit must be installed between each device and the UPS cabinet.
- If using conduit, install the interface wiring in separate conduit from the power wiring.
- All building alarm inputs require an isolated normally-open contact or switch (rated at 24 Vdc, 20 mA minimum) connected between the alarm input and common terminal. All control wiring and switch contacts are customer-supplied.
- LAN and telephone drops for use with Minislot connectivity cards must be supplied by the customer.
- The UPS battery detect signal wiring from a UPS building alarm must be connected to the battery disconnect device.
- Program the battery detect building alarm to read battery open and for normally open contacts.
- A supplemental 48 Vdc shunt trip signal for the battery disconnect device is provided, but is not required for normal operation.
- Battery detect and 48 Vdc shunt trip wiring should be a minimum of 18 AWG.
- The REPO feature opens all switchgear in the UPS cabinet and isolates power from your critical load. Local electrical codes may also require tripping upstream protective devices to the UPS.
- The REPO switch must be a latching-type switch not tied to any other circuits.
- A jumper wire must be connected between pins 3 and 4 on the REPO terminal block if using a normally-closed REPO switch.
- REPO wiring should be a minimum of 18 AWG and a maximum of 16 AWG.
- The REPO switch wiring must be in accordance with NEC Article 725 Class 2 requirements.
- The maximum distance between the REPO and the UPS cannot exceed 150m (500 ft).
- Alarm relay contacts have a maximum current rating of 5A and a switched voltage rating of 30 Vac or 28 Vdc.
- Alarm relay wiring should be a minimum of 18 AWG (recommended 18 AWG).

3.3 Inspecting and Unpacking the UPS Cabinets

The cabinet is shipped bolted to a metal and wood pallet (see [Figure 16](#) or [Figure 17](#)) with outer protective packaging material covering the cabinet.



NOTE Startup and operational checks must be performed by an authorized Eaton Customer Service Engineer, or the warranty terms specified on the product's resources page become void. See [Chapter 11 Warranty](#) for details. This service is offered as part of the sales contract for the UPS. Contact an Eaton service representative in advance (a minimum two-week notice is required) to reserve a preferred startup date.



The UPS cabinet is heavy (see [Table 3](#)). If unpacking and unloading instructions are not closely followed, the cabinet may tip and cause serious injury.

1. Carefully inspect the outer packaging for evidence of damage during transit.



Do not install a damaged cabinet. Report any damage to the carrier and contact an Eaton service representative immediately.



NOTE For the following step, verify that the forklift or pallet jack is rated to handle the weight of the cabinet (see [Table 3-2](#) for cabinet weight).

2. Use a forklift or pallet jack to move the packaged cabinet to the installation site, or as close as possible, before unpacking. If possible, move the cabinet using the pallet. Insert the forklift or pallet jack forks between the supports on the bottom of the pallet (see [Figure 11](#) or [Figure 12](#) for the UPS cabinet center of gravity measurements).



Do not tilt the UPS cabinet more than 10° from vertical or the cabinet may tip over.

3. Set the pallet on a firm, level surface, allowing a minimum clearance of 3m (10 ft) on each side for removing the cabinet from the pallet.
4. Remove the protective packaging material from the cabinet and recycle in a responsible manner. Retain any parts kits packaged with the cabinet.
5. Inspect the contents for any evidence of physical damage, and compare each item with the Bill of Lading. If damage has occurred or shortages are evident, contact an Eaton service representative immediately to determine the extent of the damage and its impact on further installation.



NOTE While waiting for installation, protect the unpacked cabinet from moisture, dust, and other harmful contaminants. Failure to store and protect the UPS properly may void the warranty.

Figure 16. UPS Cabinet as Shipped on Pallet



Figure 17. UPS Cabinet with Left or Right-Mounted Top Entry Wiring Sidecar as Shipped on Pallet



UPS with Left-Mounted Sidecar

UPS with Right-Mounted Sidecar

Figure 18. UPS Cabinet with Left or Right-Mounted Bypass Sidecar (SIAC-B) as Shipped on Pallet

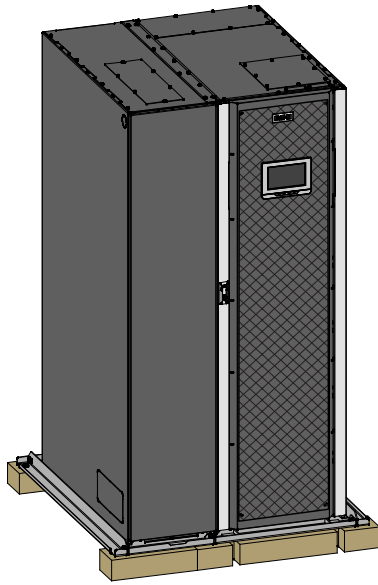

UPS with Left-Mounted SIAC-B

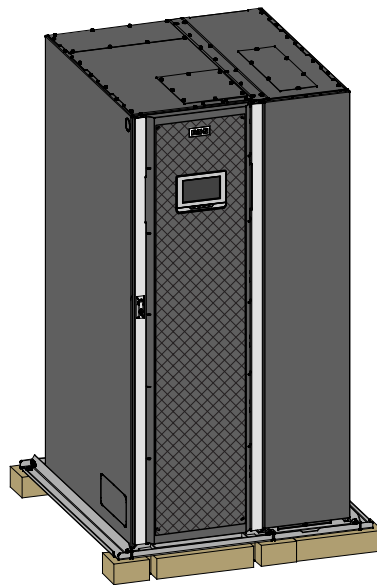

UPS with Right-Mounted SIAC-B

NOTE: Rear exhaust configuration shown.

Chapter 4 UPS System Installation

4.1 Preliminary Installation Information

WARNING

Installation should be performed only by qualified personnel.

Refer to the following while installing the UPS system:

- Review **Chapter 3 UPS Installation Plan and Unpacking** for cabinet dimensions, equipment weight, wiring and terminal data, and installation notes.
- Do not tilt the cabinets more than $\pm 10^\circ$ during installation.
- Remove conduit landing plates to add conduit landing holes as required.
- If perforated floor tiles are required for ventilation, place them in front of the UPS.

4.2 Unloading the UPS Cabinet from the Pallet

WARNING

- The UPS cabinet is heavy (see [Table 3](#)). If unpacking and unloading instructions are not closely followed, the cabinet may tip and cause serious injury.
- Do not tilt cabinet more than 10° from vertical.
- Lift the cabinets only with a forklift or damage may occur.
- Ensure the forklift is rated to handle the weight of the cabinet.

Failure to follow these instructions may result in severe injury or death.

**NOTE**

For the following steps, verify that the forklift or pallet jack is rated to handle the weight of the cabinet (see [Table 3](#) for cabinet weight).

The UPS cabinet is bolted to a pallet consisting of four metal angle supports secured to two wood supports.

To remove the pallet:

1. If not already accomplished, use a forklift or pallet jack to move the UPS cabinet to the installation area, or as close as possible, before unloading from the pallet. Insert the forklift or pallet jack forks between the supports on the bottom of the pallet (see [Figure 11](#), [Figure 12](#), or [Figure 13](#) for the UPS cabinet center of gravity measurements).
2. Open the front door by lifting the latch from the bottom and turning to the right (counterclockwise) and swing the door open.
3. Locate the four 1/2" jacking bolts from the parts kit and install them in the threaded holes in the front and rear supports as shown in [Figure 19](#). Place a floor protector from the parts kit underneath each jacking bolt, and screw the bolts down against them.

The floor protectors protect the floor from being marred by the jacking bolts.

Figure 19. Removing the Pallet Skids and Supports – Eaton 93PM UPS

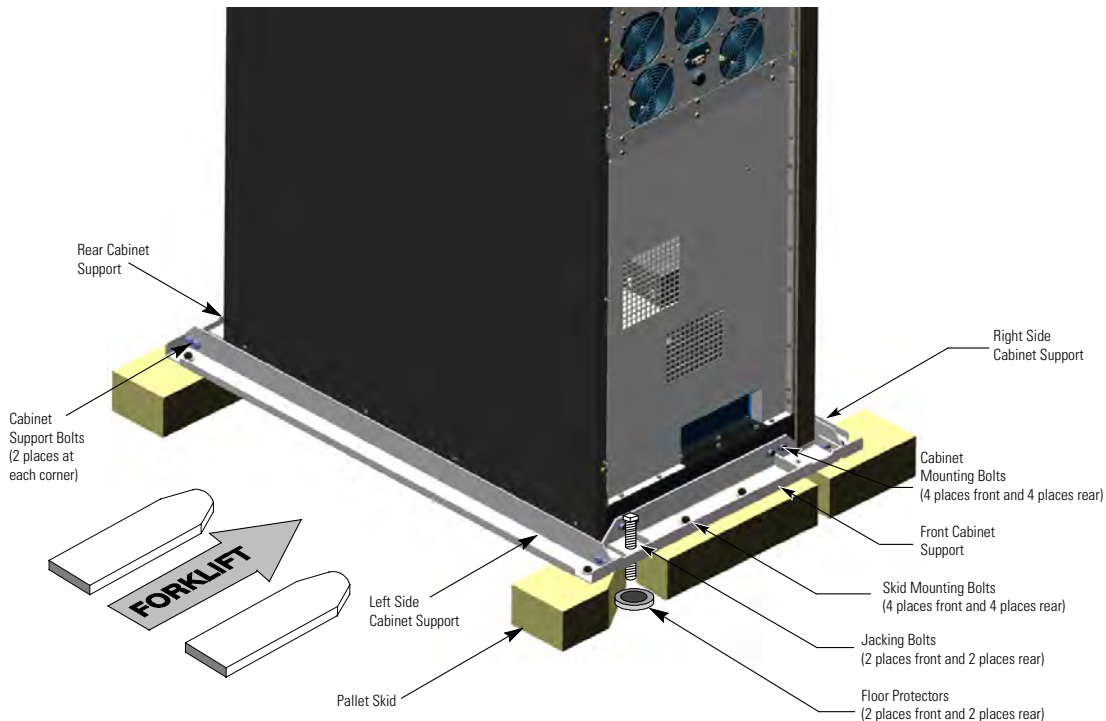

WARNING

Do not remove or loosen the cabinet mounting or cabinet support bolts until instructed. Failure to follow these instructions may result in serious injury or death.

4. Loosen, but do not remove, the skid mounting bolts holding the pallet skids to the front and rear supports, and to the left and right side supports.
5. If a sidecar is attached to the UPS, loosen, but do not remove, the sidecar skid mounting bolts holding the sidecar pallet skids to the sidecar front and rear supports, and to the left and right supports (see [Figure 19](#) and [Figure 20](#)).

WARNING

RISK OF INSTABILITY. Turning the jacking bolts unevenly may cause the cabinet to become unbalanced. To prevent tipping the cabinet, raise the cabinet no more than 3 mm (1/8") above the floor (just enough to allow the removal of the pallet skids). Failure to follow these instructions can result in serious injury or death.

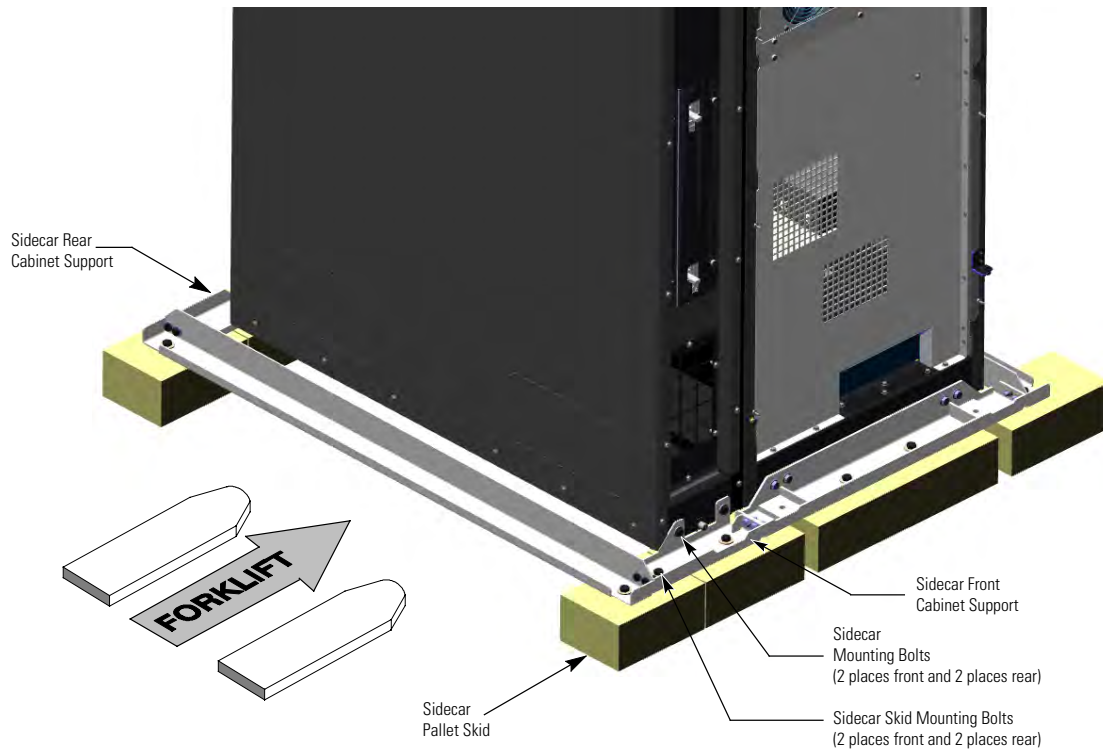
Figure 20. Removing the Sidecar Pallet Skids and Supports – Eaton 93PM UPS

6. Turn each jacking bolt consecutively, two full turns, until the pallet skids clear the floor by approximately 3 mm (1/8").
7. Remove the hardware loosened in **Step 4**.
8. If a sidecar is attached to the UPS, remove the hardware loosened in **Step 5**.
9. Pull the pallet skids out from under the metal angle supports without disturbing the jacking bolts. Recycle the pallet skids and hardware in a responsible manner.

CAUTION

CABINET MAY FALL. Do not loosen the hardware attaching the front supports to the cabinet base. The cabinet must be lowered by the jacking bolts before the supports can be removed.

10. Carefully and evenly **lower the cabinet by turning each jacking bolt consecutively two full turns (maximum)** until the casters contact the floor and the cabinet is no longer supported by the jacking bolts.
11. After the UPS is resting on the floor, remove the jacking bolts and floor protectors. Recycle them in a responsible manner.
12. Remove the cabinet support bolts fastening the front, rear, and side cabinet supports together and remove the side supports.
13. If a sidecar is attached to the UPS, remove the bottom screw securing the sidecar front panel. Lift the panel straight up to remove from the panel hanger brackets at the top of the cabinet.
14. If a sidecar is attached to the UPS, remove the sidecar mounting bolts holding the front and rear sidecar supports to the cabinet base.

15. Remove the cabinet mounting bolts holding the front and rear supports to the cabinet base.
16. If installing the cabinet permanently, retain the cabinet mounting bolts; otherwise, recycle the bolts along with the support brackets in a responsible manner.
17. Close the door and secure the latch.
18. If a sidecar is attached to the UPS, remove the screws securing sidecar rear shipping bracket. Remove the bracket and reinstall the screws (see [Figure 21](#)).
19. If the leveling feet are not retracted, turn all four leveling feet until they are retracted as far into the cabinet as possible.

CAUTION

To prevent tipping when rolling the cabinet, push the cabinet from the rear whenever possible.

20. Roll the cabinet to the final installation location.
21. Lower the UPS's feet and using a level, adjust the feet accordingly until the cabinet is level.
22. If installing the IBC adjacent to the UPS, locate the top splice bracket shipped with the IBC; otherwise go to **Step 25**.
23. Remove the screws along each adjacent cabinet top panel securing the top panels. Retain the hardware for later use.
24. Install the top splice bracket between the adjacent cabinet and secure the tie strap with retained hardware.



NOTE

Either front and back floor mounting brackets or left and right side floor mounting brackets are available for permanently mounting the UPS.

25. If permanently mounting the UPS using the left and right side floor mounting brackets, proceed to **Step 26**; if using the front and rear floor mounting brackets, proceed to **Step 30**; otherwise, proceed to **Step 33**.
26. Locate the left and right side floor mounting brackets from the floor mounting kit.
27. Using the retained cabinet mounting bolts, install the floor mounting brackets to the left and right side of the UPS with the angle facing outward.
28. Secure the cabinet to the floor with customer-supplied hardware.
29. Proceed to paragraph [4.3 Integrated Battery Cabinet Installation](#).
30. Locate the front and back floor mounting brackets from the floor mounting kit.
31. Using the retained cabinet mounting bolts, install the floor mounting brackets to the front and rear of the UPS with the angle facing outward.
32. Secure the cabinet to the floor with customer-supplied hardware.



NOTE

Black cover dots are provided, if side mounting bracket holes need to be covered for aesthetic reasons.

33. Locate the black cover dots from the parts kit and install over the left and right side bracket mounting holes.
34. Proceed to paragraph [4.3 Integrated Battery Cabinet Installation](#).

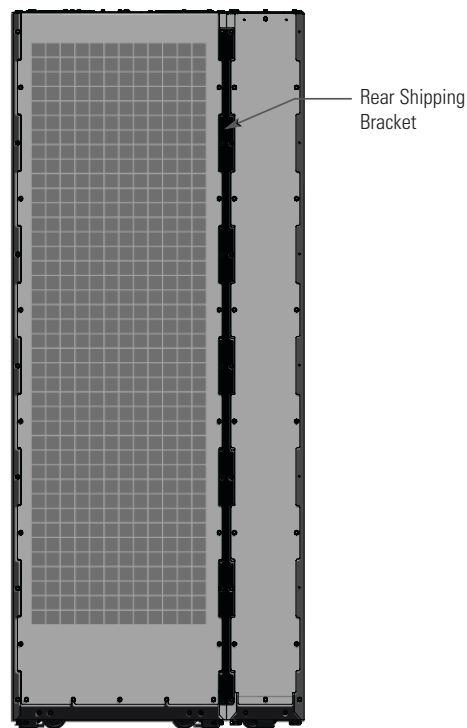
Figure 21. Removing the Sidecar Rear Shipping Bracket – Eaton 93PM UPS

4.3 Integrated Battery Cabinet Installation

If installing Integrated Battery Cabinets (IBCs), refer to the *Eaton 93PM Integrated Battery Cabinet Installation Manual-Large and Large High Rate* or the *Eaton 93PM Universal Integrated Battery Cabinet Installation Manual-Large and Large High Rate*, listed in paragraph [1.8 For More Information](#), for installation instructions.

After the IBC is installed, proceed to paragraph [4.4 Sidecar Integrated Accessory Cabinet-Bypass Wiring Installation](#) if a Sidecar Integrated Accessory Cabinet-Bypass (SIAC-B) is attached to the UPS; proceed to paragraph [4.5 Integrated Accessory Cabinet-Tie](#) if installing an Integrated Accessory Cabinet-Tie (IAC-T), or to paragraph [4.6 Integrated Accessory Cabinet-Distribution](#) if installing Integrated Accessory Cabinet-Distribution; or to paragraph [4.7 Integrated Accessory Cabinet-Power Distribution](#) if installing Integrated Accessory Cabinet-Power Distribution; otherwise, proceed to paragraph [4.8 External AC Power Wiring Installation](#) to complete the wiring of the UPS.

4.4 Sidecar Integrated Accessory Cabinet-Bypass Wiring Installation

If an SIAC-B is attached to the UPS, refer to the *Eaton 93PM Sidecar Integrated Accessory Cabinet-Bypass Installation and Operation (150 kW and 200 kW SIAC-B) Manual*, listed in paragraph [1.8 For More Information](#), for wiring installation instructions.

After the SIAC-B is wired, proceed to paragraph [4.5 Integrated Accessory Cabinet-Tie](#) if installing an Integrated Accessory Cabinet-Tie (IAC-T), or to paragraph [4.6 Integrated Accessory Cabinet-Distribution](#) if installing Integrated Accessory Cabinet-Distribution; or to paragraph [4.7 Integrated Accessory Cabinet-Power Distribution](#) if installing Integrated Accessory Cabinet-Power Distribution; otherwise, proceed to paragraph [4.8 External AC Power Wiring Installation](#) to complete the wiring of the UPS.

4.5 Integrated Accessory Cabinet-Tie

If an IAC-T is attached to the UPS, refer to the *Eaton 93PM Integrated Accessory Cabinet-Tie (150 kW and 200 kW IAC-T) Installation and Operation Manual*, listed in paragraph [1.8 For More Information](#), for wiring installation instructions.

After the IAC-T is wired, proceed to paragraph [4.6 Integrated Accessory Cabinet-Distribution](#) if installing Integrated Accessory Cabinet-Distribution; or to paragraph [4.7 Integrated Accessory Cabinet-Power Distribution](#) if installing Integrated Accessory Cabinet-Power Distribution; otherwise, proceed to paragraph [4.8 External AC Power Wiring Installation](#) to complete the wiring of the UPS.

4.6 Integrated Accessory Cabinet-Distribution

If installing Integrated Accessory Cabinet-Distribution (IAC-D), refer to the *Eaton 93PM Integrated Accessory Cabinet-Distribution (50 kW, 100 kW, 150 kW, and 200 kW IAC-D) Installation and Operation Manual*, listed in paragraph [1.8 For More Information](#), for installation instructions.

After the IAC-D is wired, proceed to paragraph [4.7 Integrated Accessory Cabinet-Power Distribution](#) if installing Integrated Accessory Cabinet-Power Distribution; otherwise, proceed to paragraph [4.8 External AC Power Wiring Installation](#) to complete the wiring of the UPS.

4.7 Integrated Accessory Cabinet-Power Distribution

If installing Integrated Accessory Cabinet-Power Distribution (IAC-PD), refer to the *Eaton 93PM Integrated Accessory Cabinet-Power Distribution Installation and Operation Manual*, listed in paragraph [1.8 For More Information](#), for installation instructions.

After the IAC-PD is wired, proceed to paragraph [4.8 External AC Power Wiring Installation](#) to complete the wiring of the UPS.

4.8 External AC Power Wiring Installation



IMPORTANT

This product has been evaluated for use with **copper wire only**. For external wiring, use only 75°C copper wire.

To install wiring:

1. Open the front door by lifting the latch from the bottom and turning to the right (counterclockwise) and swing the door open.
2. Remove the screws securing the bottom internal safety shield panel and remove the panel to gain access to the input, output, and battery power wiring terminals. Retain the hardware for later use.
3. If wiring the UPS using the top entry sidecar, proceed to **Step 7**; otherwise proceed to **Step 4**.
4. **Bottom Entry Wiring.** Remove the bottom conduit plate (see [Figure 22](#)) from the inside bottom of the UPS. Identify all conduit requirements and mark their location. Drill and punch all conduit holes in the bottom conduit plate prior to mounting on the UPS. Install the conduit plate and install all conduit runs into the plate. Pull the wiring through conduit into the wiring area.
5. Route the input and output cables through the bottom of the cabinet to the UPS terminals. See [Figure 22](#) for wiring access information, and [Figure 25](#) for terminal locations.
6. Proceed to **Step 11**.
7. If not already accomplished, remove the bottom screw securing the sidecar front panel. Lift the panel straight up to remove from the panel hanger brackets at the top of the cabinet.

8. Remove the screws securing the sidecar internal safety shield panel and remove the panel to gain access to the interior of the sidecar and the UPS inter-cabinet wiring access pass-through. Retain the hardware for later use.
9. **Top Entry Wiring.** Remove the top conduit plate (see [Figure 23](#)) from the top of the sidecar. Identify all conduit requirements and mark their location. Drill and punch all conduit holes in the top conduit plate prior to mounting on the sidecar. Install the conduit plate and install all conduit runs into the plate. Pull the wiring through the conduit into the wiring area.
10. Route the input and output cables through the top of the UPS sidecar and the UPS inter-cabinet wiring access pass-through to the UPS terminals. See [Figure 23](#) and [Figure 24](#) for wiring access information, and [Figure 25](#) for terminal locations.

⚠ WARNING

As a result of the connected loads high leakage current is possible. Connection to earth ground is required for safety and proper product operation. Do not check UPS operation by any action that includes removal of the earth (ground) connection with loads attached.

11. Ground the UPS according to local and/or national electrical wiring codes by routing and connecting the ground wire to the input ground lug. See [Figure 26](#) for UPS terminal locations.
12. Connect phase A, B, and C rectifier input power wiring from the utility source to the rectifier input terminals. See paragraph [3.2.2 UPS System Power Wiring Preparation](#) for wiring and termination requirements.
13. Connect phase A, B, and C bypass input power wiring from the utility source to the bypass input terminals.
For a detailed view of the UPS terminal blocks, see [Figure 26](#).
14. If wiring an external parallel system, proceed to **Step 15**; otherwise, proceed to **Step 17**.

⚠ CAUTION

External parallel system wiring length should be in accordance with [Figure 15](#), to ensure approximately equal current sharing when in Bypass mode.

15. Connect phase A, B, and C power wiring from the output terminals of each UPS to the tie cabinet.
For a detailed view of the UPS terminal blocks, see [Figure 26](#).
16. Proceed to **Step 18**.
17. Connect phase A, B, and C power wiring from output terminals to the critical load. See paragraph [3.2.2 UPS System Power Wiring Preparation](#) for wiring and termination requirements.
For a detailed view of the UPS terminal blocks, see [Figure 26](#).
18. Proceed to paragraph [4.9 Battery Power Wiring](#).

Figure 22. UPS Conduit and Wire Entry Locations

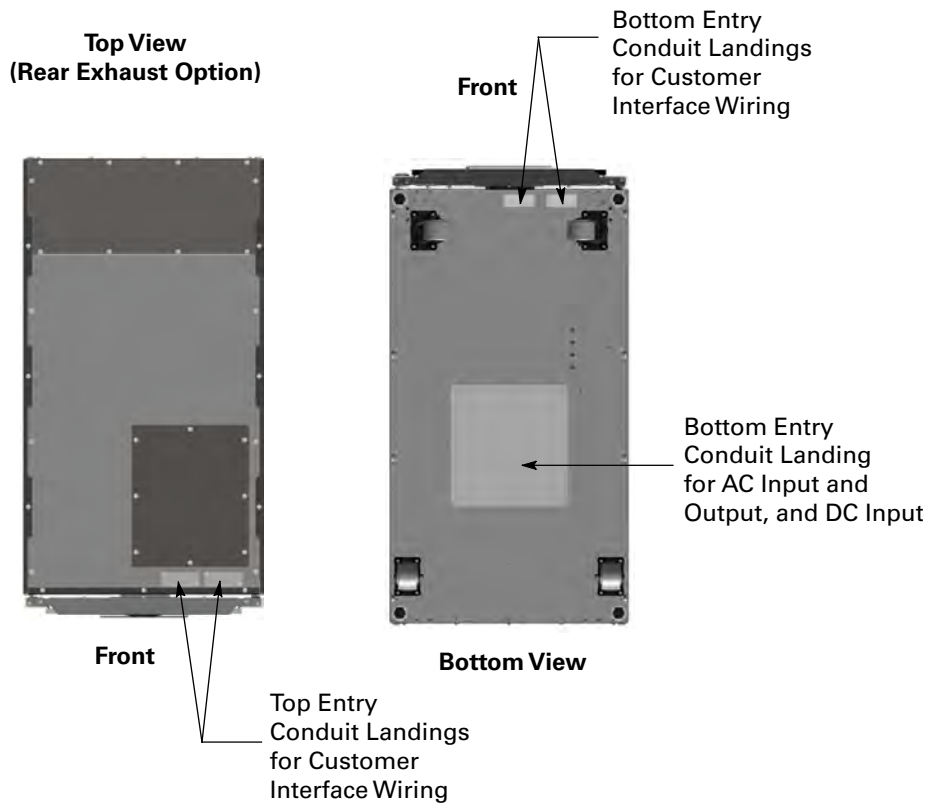

NOTE: Remove panels to drill or punch conduit holes.

Figure 23. Sidecar Conduit and Wire Entry Locations

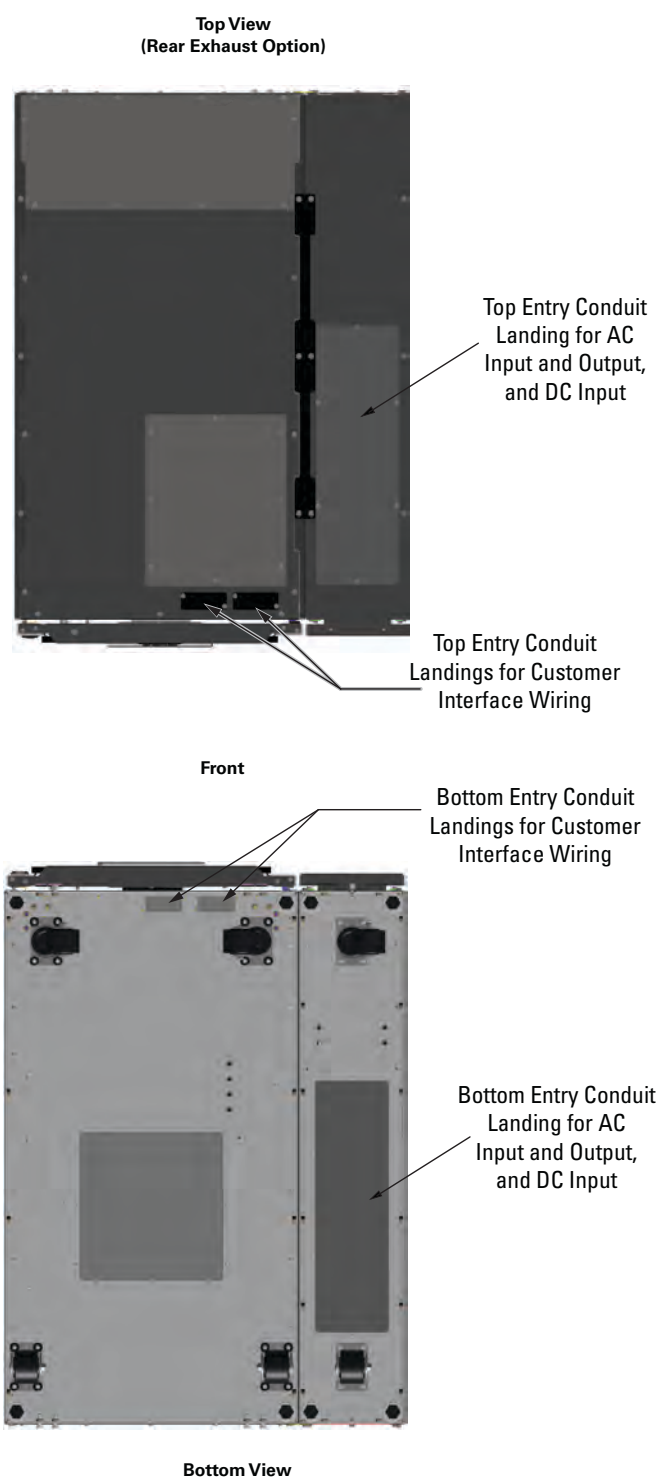

NOTE: Remove panels to drill or punch conduit holes.

Figure 24. UPS Inter-Cabinet Wiring Access Location

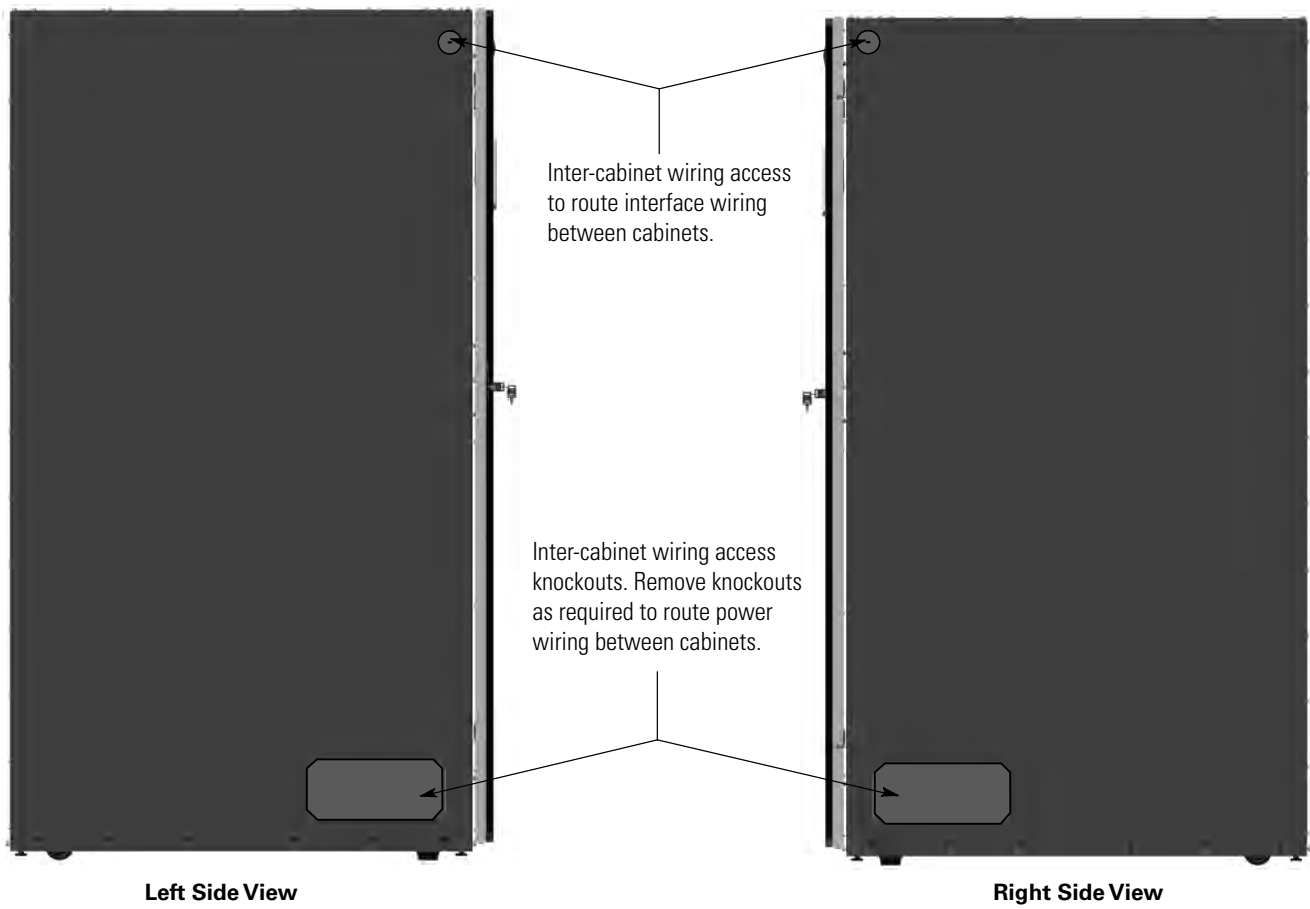

Figure 25. Power Terminal Locations

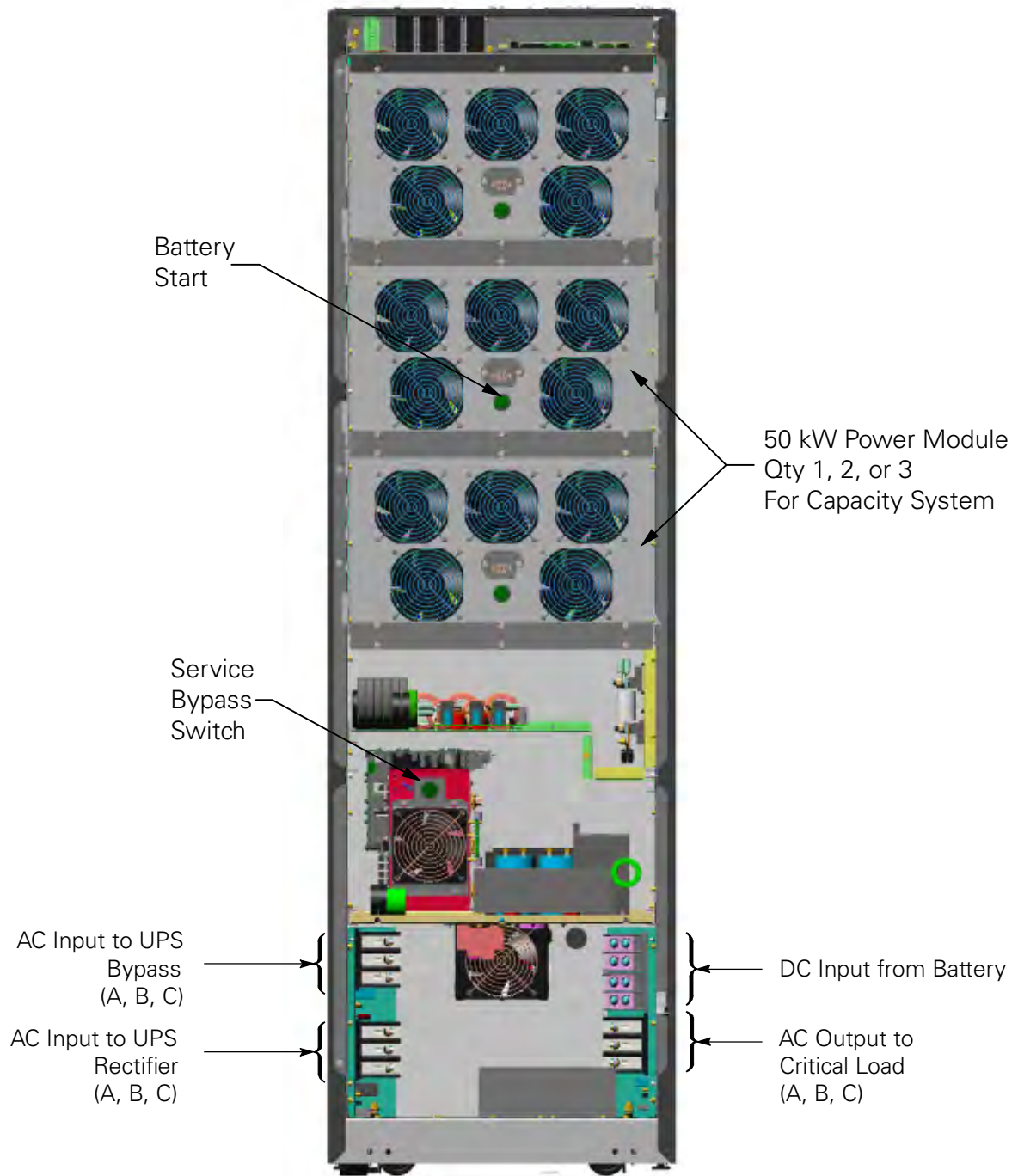
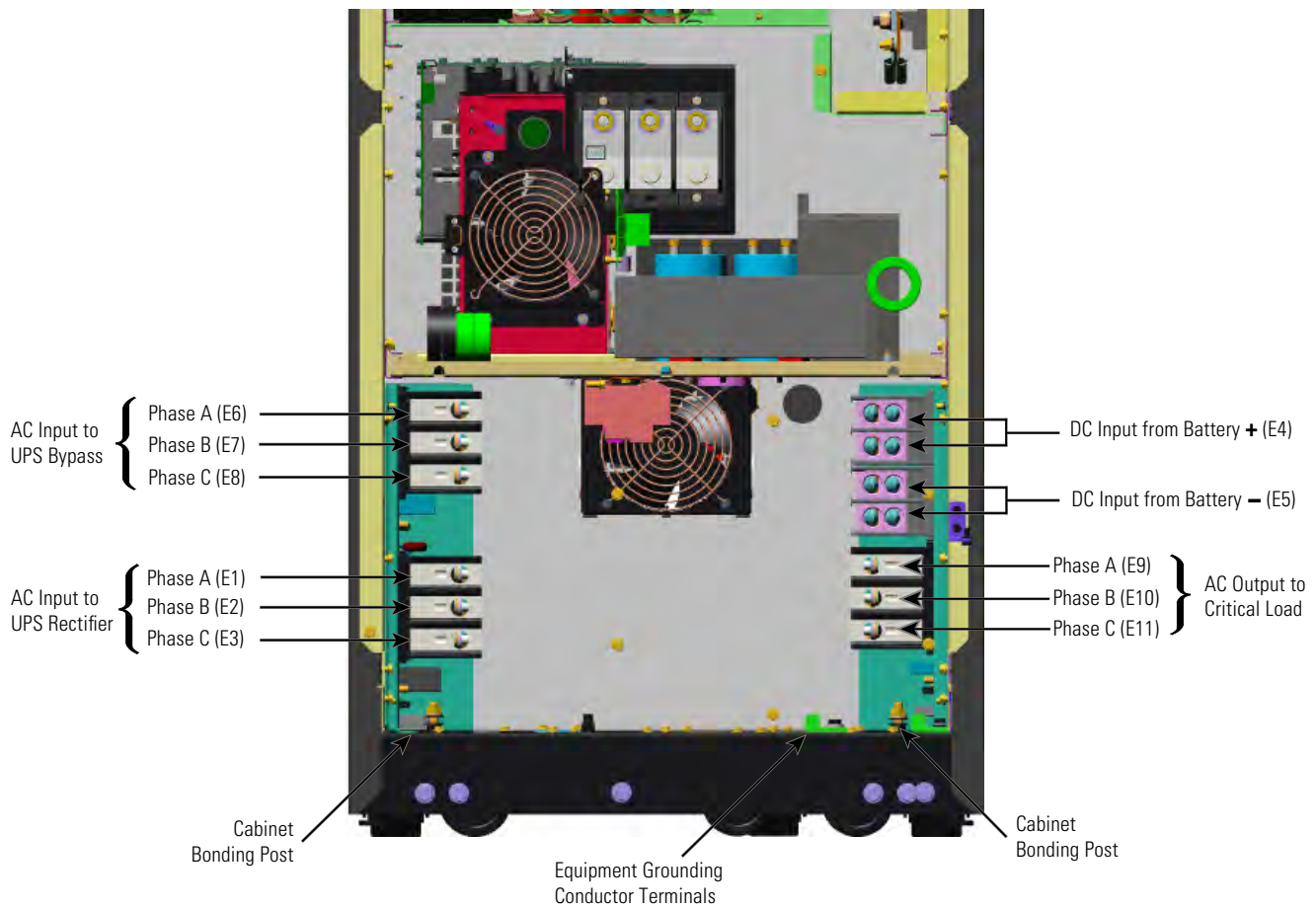

Figure 26. Power Terminal Detail



4.9 Battery Power Wiring

CAUTION

When sizing the battery system, do not exceed the internal battery charger capabilities. See **Chapter 10 Product Specifications**, for maximum battery charger currents.

To install wiring:

1. Route and connect the battery cables between the UPS and battery cabinet or battery disconnect according to the instructions in the *Eaton 93PM Integrated Battery Cabinet Installation Manual – Large and Large High Rate*, the *Eaton 93PM Universal Integrated Battery Cabinet Installation Manual-Large and Large High Rate*, the *Eaton 93PM Integrated Battery Cabinet Installation Manual-Small*, or the *Eaton 93PM Integrated Battery Cabinet-Small Welded IBC-SW (432V and 480V) Installation Manual*, listed in paragraph [1.8 For More Information](#).

See [Figure 22](#), [Figure 23](#), and [Figure 24](#) for wiring access information, and [Figure 25](#) for terminal locations.

2. Ground the system according to local and/or national electrical wiring codes.

3. Connect the ground, positive, and negative DC power wiring from the battery cabinet or disconnect to the UPS cabinet battery and ground terminals. See paragraph [3.2.2 UPS System Power Wiring Preparation](#) for wiring and termination requirements.

For a detailed view of the UPS terminal block, see [Figure 26](#).

4. If wiring interface connections, proceed to paragraph [4.10 Installing Interface Connections](#); otherwise, proceed to **Step 5**.
5. Reinstall all safety shield panels previously removed and secure with the retained hardware.
6. If removed, reinstall the sidecar front panel and secure with the retained hardware.
7. Close the UPS outside door and secure the latch.

4.10 Installing Interface Connections



NOTE

If installing the IAC-D CT wiring, refer to the *Eaton 93PM Integrated Accessory Cabinet-Distribution (50 kW, 100 kW, 150 kW, and 200 kW IAC-D) Installation and Operation Manual*, listed in paragraph [1.8 For More Information](#), for installation instructions.

Use the procedures in the following paragraphs to connect the customer and battery interface connections.

4.10.1 Installing Building Alarm and Relay Contact Connections



NOTE 1

If installing interface wiring connections between standalone cabinets or separate devices, conduit must be installed between each cabinet or device.

NOTE 2

Disconnect terminal block plugs from terminal blocks to wire plugs.

To install wiring:

1. Verify the UPS system is turned off and all power sources are removed. See [Chapter 7 UPS Operating Instructions](#), for shutdown instructions.
2. If not already opened, open the front door by lifting the latch from the bottom and turning to the right (counterclockwise) and swing the door open.
3. If wiring the interface terminals from the bottom of the UPS, proceed to **Step 8**; otherwise, proceed to **Step 4**.
4. **Top Entry Wiring.** Remove the top interface entry conduit landing plates to drill or punch holes (see [Figure 22](#)).
5. Reinstall the interface entry plates and install the conduit.
6. Route the UPS building alarm and relay output interface wiring through the top interface entry conduit landing plates to the UPS building alarm and relay output terminals. See [Figure 27](#) and [Figure 28](#) for UPS interface terminal locations.
7. Proceed to **Step 13**.
8. **Bottom Entry Wiring.** Remove the bottom interface entry conduit landing plates to drill or punch holes (see [Figure 23](#)).
9. Reinstall the interface entry plates and install the conduit.
10. Route the UPS building alarm and relay output interface wiring through the bottom interface entry conduit landing plates to the bottom access interface wiring channel along the inside of the front door (see [Figure 29](#)).
11. Route the wiring along the interface wiring channel to the UPS building alarm and relay output terminals. See [Figure 27](#) and [Figure 28](#) for UPS interface terminal locations.

12. Secure the wiring to the wire tie anchors provided (see [Figure 30](#)) using Zip ties.
13. Connect the building alarm interface wiring to the building alarm terminals. See paragraph [3.2.4 UPS System Interface Wiring Preparation](#) and [Table 14](#) for wiring and termination requirements, and [Figure 31](#) for terminal assignments.
14. Connect the relay output interface wiring to the relay output terminals. See [Table 15](#) for wiring and termination requirements, and [Figure 32](#) for terminal assignments.
15. If wiring battery detect connections, proceed to paragraph [4.10.2 Installing Battery Detect Interface Connections](#); if wiring battery shunt trip connections, proceed to paragraph [4.10.3 Installing Battery Shunt Trip Interface Connections](#); if wiring generator interface connections, proceed to paragraph [4.10.4 Generator Interface Connections](#); if wiring external parallel CAN connections, proceed to paragraph [4.10.5 Installing External Parallel CAN Control Wiring and Connections](#); if wiring external parallel pull chain connections, proceed to paragraph [4.10.6 Installing External Parallel Pull Chain Control Wiring and Connections](#); if wiring Minislot connections, proceed to paragraph [4.10.7 Installing Minislot Interface Connections](#); if wiring REPO connections, proceed to paragraph [4.11 Installing a REPO Switch](#); otherwise, proceed to **Step 16**.
16. Close the UPS outside door and secure the latch.

Figure 27. Interface Terminal Locations

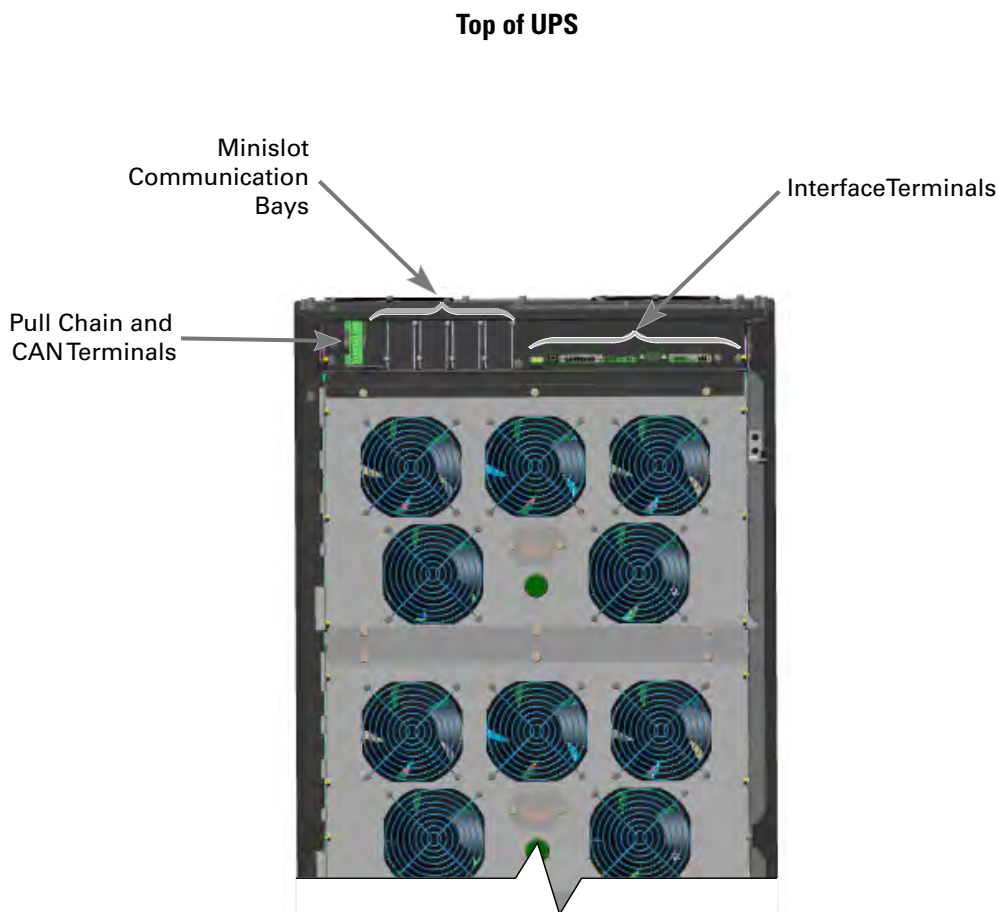

Figure 28. Interface Terminal Detail

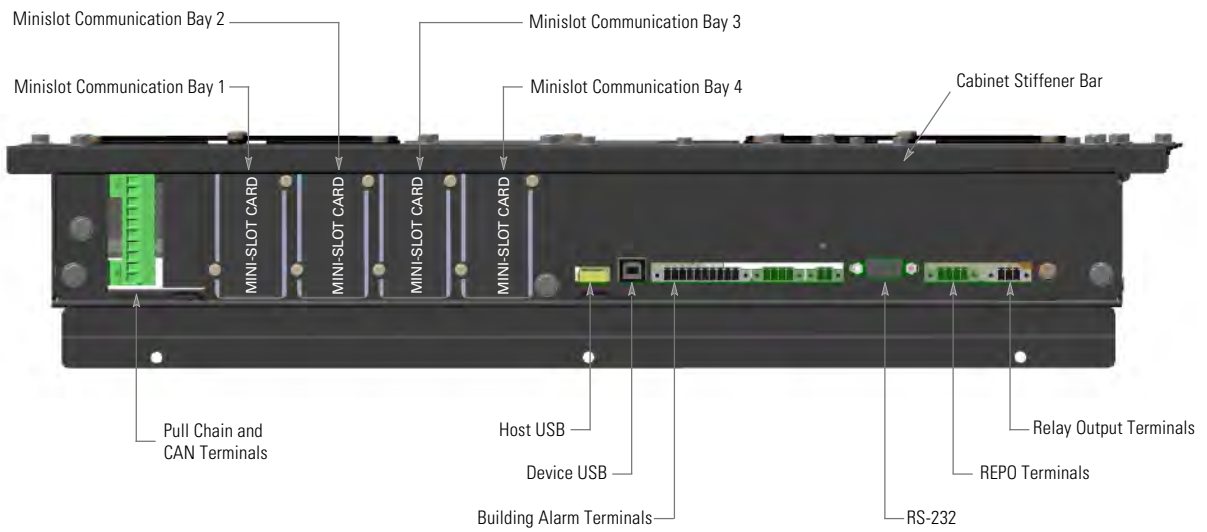

Figure 29. Bottom Access Interface Wiring Location

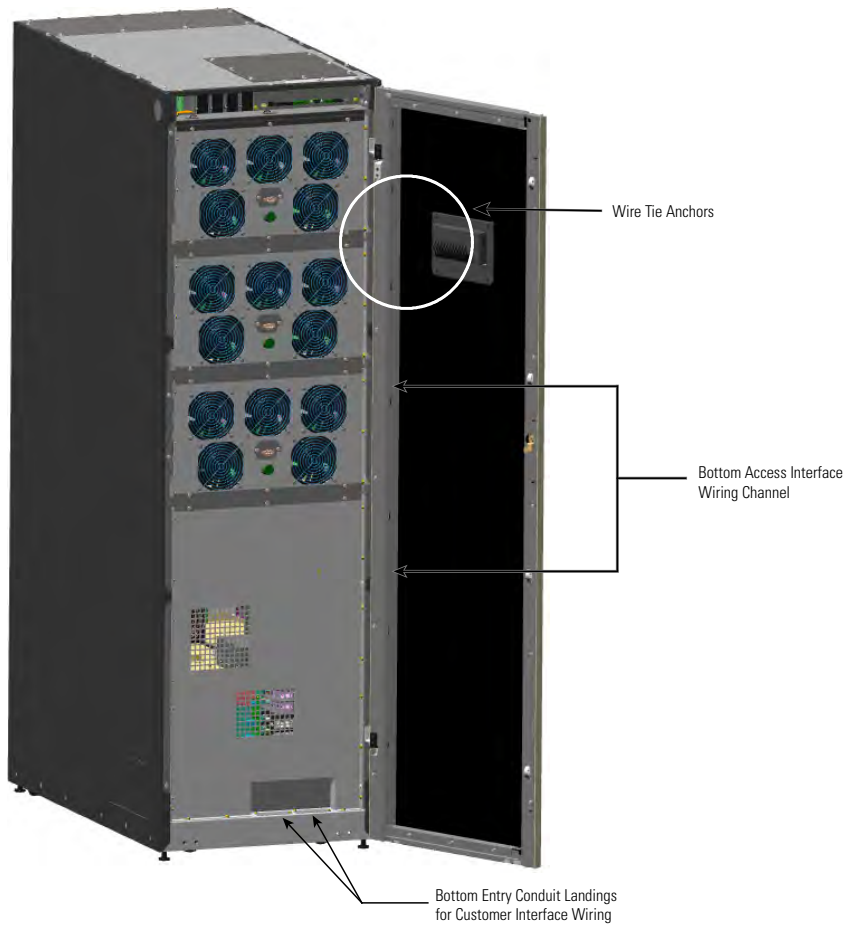
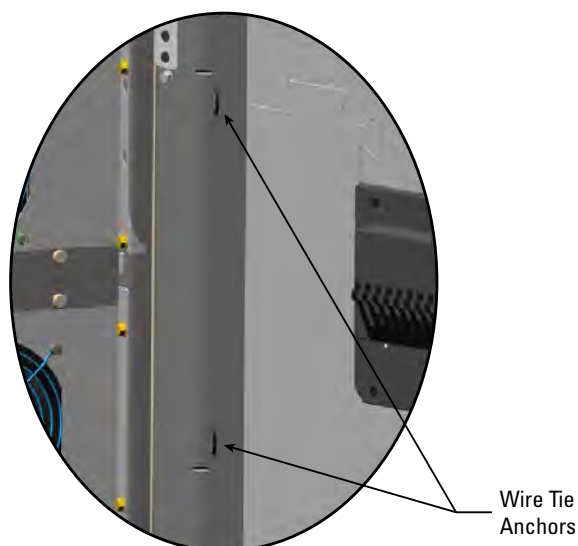

Figure 30. Wire Tie Anchors**Table 14. Building Alarm Connections and Wire Terminations**

Terminal	Name	Description	Recommended Wire Size	Size of Pressure Termination	Tightening Torque
10	Building Alarm 1				
9	Building Alarm 1 Return				
8	Building Alarm 2				
7	Building Alarm 2 Return				
6	Building Alarm 3	Input: Programmable UPS alarm, activated by a remote dry contact closure	Twisted Pair Wires #18 AWG	#14-#30 AWG	2 lb in (0.22-0.25 Nm)
5	Building Alarm 3 Return				
4	Building Alarm 4				
3	Building Alarm 4 Return				
2	Building Alarm 5				
1	Building Alarm 5 Return				

Figure 31. Building Alarm Terminal Block Connector Assignments

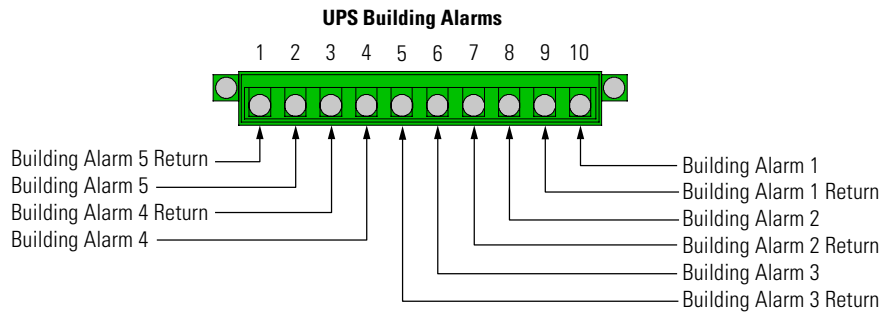
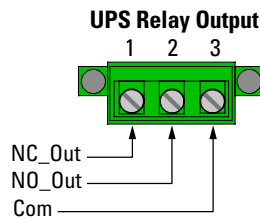



Table 15. Relay Contact Connections and Wire Terminations

Terminal	Name	Description	Recommended Wire Size	Size of Pressure Termination	Tightening Torque
1	Relay Contact NC	Output: General purpose normally-closed (NC) relay contact	Twisted Pair Wires #18 AWG	#14-#30 AWG	2 lb in (0.22-0.25 Nm)
3	Relay Contact Common				
2	Relay Contact NO	Output: General purpose normally-open (NO) relay contact	#18 AWG	#14-#30 AWG	2 lb in (0.22-0.25 Nm)
3	Relay Contact Common				

Figure 32. Relay Contact Terminal Block Connector Assignments



4.10.2 Installing Battery Detect Interface Connections

-
- NOTE 1** The UPS battery detect signal uses a UPS building alarm input to indicate an open battery breaker.
- NOTE 2** Any pair of unused building alarm terminals may be used for the battery detect connections.
-  **NOTE 3** Program the battery detect building alarm to read battery open and for normally open contacts.
- NOTE 4** If installing interface wiring connections between standalone cabinets, conduit must be installed between cabinets.
- NOTE 5** Disconnect terminal block plugs from terminal blocks to wire plugs.
-

To install wiring:

1. Verify the UPS system is turned off and all power sources are removed. See [Chapter 7 UPS Operating Instructions](#), for shutdown instructions.
2. If not already opened, open the front door by lifting the latch from the bottom and turning to the right (counterclockwise) and swing the door open.
3. If wiring the battery detect connections using the inter-cabinet wiring access pass-through (line-up-and-match configurations), proceed to **Step 4**; if wiring the battery interface connections using bottom entry access, proceed to **Step 6**; if wiring the battery interface connections using top entry access, proceed to **Step 12**.

Refer to the *Eaton 93PM Integrated Battery Cabinet Installation Manual – Large and Large High Rate*, the *Eaton 93PM Universal Integrated Battery Cabinet Installation Manual-Large and Large High Rate*, the *Eaton 93PM Integrated Battery Cabinet Installation Manual-Small*, or the *Eaton 93PM Integrated Battery Cabinet-Small Welded IBC-SW (432V and 480V) Installation Manual*, listed in paragraph [1.8 For More Information](#), for battery cabinet wiring access information and instructions.

4. **Pass-through Wiring.** Route the battery detect wiring from the battery cabinet through the top UPS inter-cabinet wiring access pass-through to the UPS building alarm terminals. See [Figure 24](#) for UPS wiring access information, and [Figure 27](#) and [Figure 28](#) for UPS terminal locations.
5. Proceed to **Step 15**.
6. **Bottom Entry Wiring.** Remove the bottom interface entry conduit landing plate to drill or punch holes (see [Figure 23](#)).
7. Reinstall the interface entry plate and install the conduit.
8. Route the battery detect wiring from the battery cabinet through the bottom interface entry conduit landing plate to the bottom access interface wiring channel along the inside of the front door (see [Figure 29](#)).
9. Route the wiring along the interface wiring channel to the UPS building alarm terminals. See [Figure 27](#) and [Figure 28](#) for UPS interface terminal locations.
10. Secure the wiring to the wire tie anchors provided (see [Figure 30](#)) using Zip ties.
11. Proceed to **Step 15**.
12. **Top Entry Wiring.** Remove the top interface entry conduit landing plate to drill or punch holes (see [Figure 22](#)).
13. Reinstall the interface entry plate and install the conduit.

14. Route the battery detect wiring from the battery cabinet through the top interface entry conduit landing plate to the UPS building alarm terminals. See [Figure 22](#) for wiring access information, and [Figure 27](#) and [Figure 28](#) for UPS interface terminal locations.
15. Connect the battery detect wiring to one pair of building alarm terminals. See paragraph [3.2.4 UPS System Interface Wiring Preparation](#) and [Table 14](#) for wiring and termination requirements, and [Figure 31](#) for terminal assignments.
16. If wiring battery shunt trip connections, proceed to paragraph [4.10.3 Installing Battery Shunt Trip Interface Connections](#); if wiring generator interface connections, proceed to paragraph [4.10.4 Generator Interface Connections](#); if wiring external parallel CAN connections, proceed to paragraph [4.10.5 Installing External Parallel CAN Control Wiring and Connections](#); if wiring external parallel pull chain connections, proceed to paragraph [4.10.6 Installing External Parallel Pull Chain Control Wiring and Connections](#); if wiring Minislot connections, proceed to paragraph [4.10.7 Installing Minislot Interface Connections](#); if wiring REPO connections, proceed to paragraph [4.11 Installing a REPO Switch](#); otherwise, proceed to **Step 17**.
17. Close the UPS outside door and secure the latch.

4.10.3 Installing Battery Shunt Trip Interface Connections



NOTE 1 If installing interface wiring connections between standalone cabinets, conduit must be installed between cabinets.

NOTE 2 Disconnect terminal block plugs from terminal blocks to wire plugs.

To install wiring:

1. Verify the UPS system is turned off and all power sources are removed. See [Chapter 7 UPS Operating Instructions](#), for shutdown instructions.
2. If not already opened, open the front door by lifting the latch from the bottom and turning to the right (counterclockwise) and swing the door open.
3. If not already removed, remove the screws securing the bottom internal safety shield panel and remove the panel. Retain the hardware for later use.
4. Remove the screws securing the internal safety shield panel above the bottom safety panel and remove the panel to gain access to the battery shunt trip wiring terminals. Retain the hardware for later use.
5. If wiring the battery shunt trip connections using the inter-cabinet wiring access pass-through (line-up-and-match configurations), proceed to **Step 6**; if wiring the battery shunt trip connections using bottom entry access, proceed to **Step 8**; if wiring the battery shunt trip connections using top entry access, proceed to **Step 10**.

Refer to the *Eaton 93PM Integrated Battery Cabinet Installation Manual – Large and Large High Rate*, the *Eaton 93PM Universal Integrated Battery Cabinet Installation Manual-Large and Large High Rate*, the *Eaton 93PM Integrated Battery Cabinet Installation Manual-Small*, or the *Eaton 93PM Integrated Battery Cabinet-Small Welded IBC-SW (432V and 480V) Installation Manual*, listed in paragraph [1.8 For More Information](#), for battery cabinet wiring access information and instructions.

6. **Pass-through Wiring.** Route the battery shunt trip wiring from the battery cabinet through the bottom UPS inter-cabinet wiring access pass-through and static switch shelf bushing to the UPS battery shunt trip terminals. See [Figure 24](#) for UPS wiring access information, and [Figure 33](#) and [Figure 34](#) for UPS terminal locations.
7. Proceed to **Step 11**.
8. **Bottom Entry Wiring.** Route the battery shunt trip wiring from the battery cabinet or battery disconnect through the bottom of the UPS and static switch shelf bushing to the UPS battery shunt trip terminals. See [Figure 22](#) for UPS wiring access information, and [Figure 33](#) and [Figure 34](#) for UPS terminal locations.

9. Proceed to **Step 11**.
10. **Top Entry Wiring.** Route the battery shunt trip wiring from the battery cabinet or battery disconnect through the top of the UPS sidecar and the bottom UPS inter-cabinet wiring access pass-through and static switch shelf bushing to the UPS battery shunt trip terminals. See [Figure 23](#) and [Figure 24](#) for UPS wiring access information, and [Figure 33](#) and [Figure 34](#) for UPS terminal locations.
11. Connect the wiring to the battery shunt trip terminals. See paragraph [3.2.4 UPS System Interface Wiring Preparation](#) and [Table 16](#) for wiring and termination requirements, and [Figure 35](#) for terminal assignments.
12. If wiring generator interface connections, proceed to paragraph [4.10.4 Generator Interface Connections](#); if wiring external parallel CAN connections, proceed to paragraph [4.10.5 Installing External Parallel CAN Control Wiring and Connections](#); if wiring external parallel pull chain connections, proceed to paragraph [4.10.6 Installing External Parallel Pull Chain Control Wiring and Connections](#); if wiring Minislot connections, proceed to paragraph [4.10.7 Installing Minislot Interface Connections](#); if wiring REPO connections, proceed to paragraph [4.11 Installing a REPO Switch](#); otherwise, proceed to **Step 13**.
13. Reinstall all safety shield panels previously removed and secure with the retained hardware.
14. If removed, reinstall the sidecar front panel and secure with the retained hardware.
15. Close the UPS outside door and secure the latch.

Figure 33. Battery Shunt Trip Location

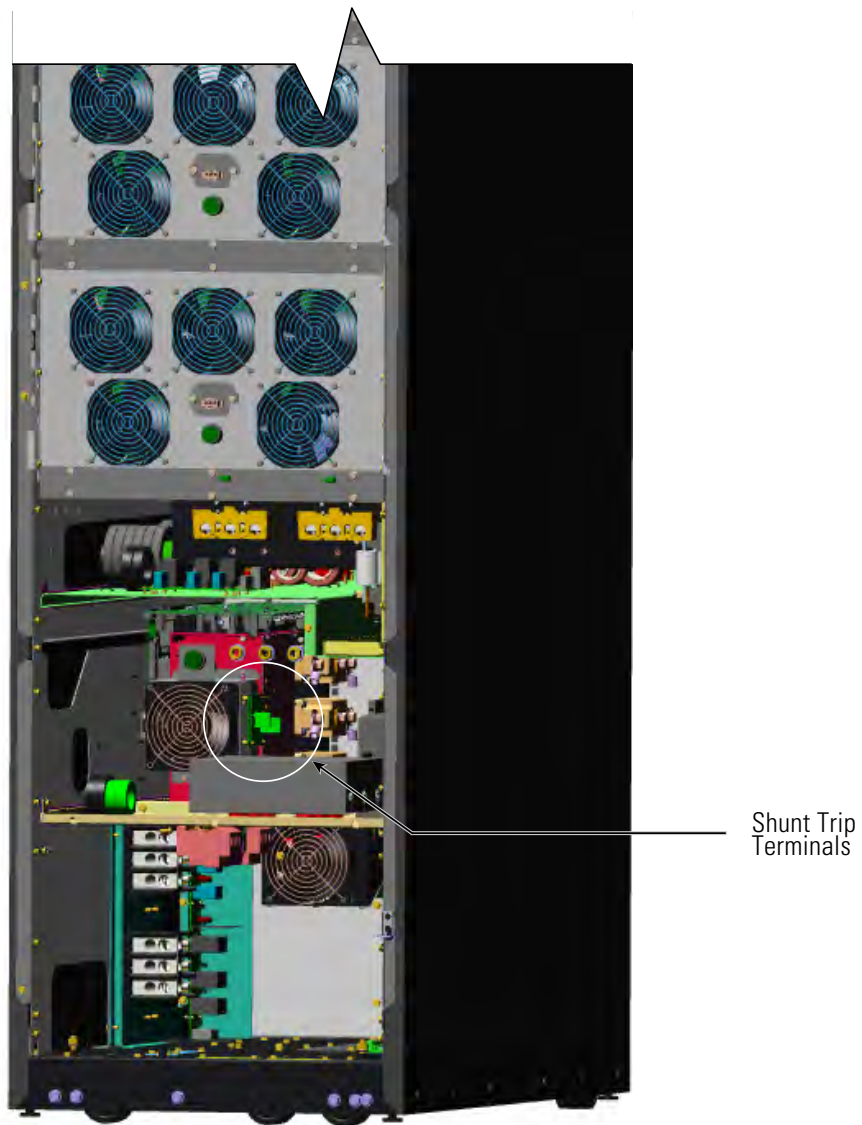

Figure 34. Battery Shunt Trip Terminal Detail

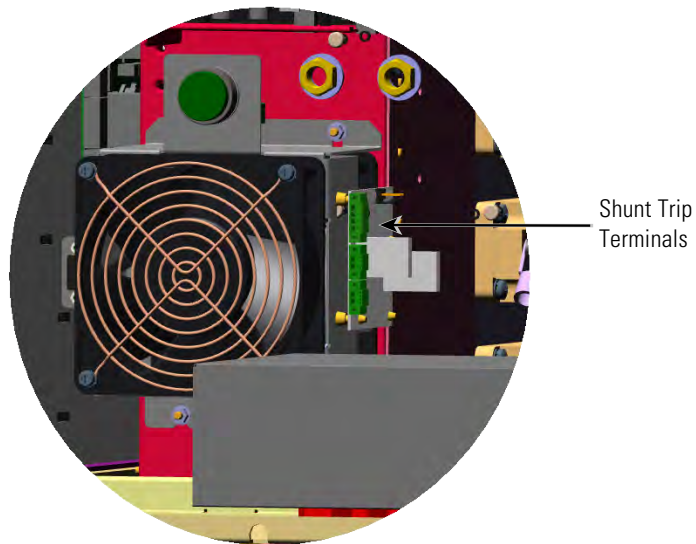
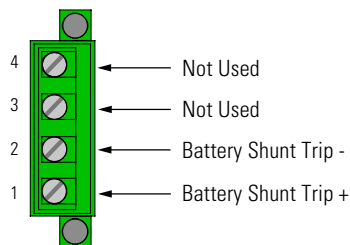

Table 16. Battery Shunt Trip Connections and Wire Terminations

Terminal	Name	Description	Recommended Wire Size	Size of Pressure Termination	Tightening Torque
1	48 Vdc Battery Shunt Trip +	Output: Contacts used to open battery breaker or disconnect	Twisted Pair Wires #18 AWG	#14-#30 AWG	2 lb in (0.22-0.25 Nm)
2	48 Vdc Battery Shunt Trip -				
3	Not Used				
4	Not Used				

Figure 35. Battery Shunt Trip Terminal Assignments



4.10.4 Generator Interface Connections

If ESS is enabled and the UPS will be fed by a site generator at any time, the On Generator building alarm must be wired and configured to a Building Alarm Input. Wiring the On Generator sensing circuit to a building alarm allows the UPS to optimize its operation with the generator by transferring the UPS from ESS mode to Normal (double conversion) mode.

-
- NOTE 1** A UPS building alarm input is used to indicate On Generator.
- NOTE 2** Any pair of unused building alarm terminals may be used for On Generator connections.
-  **NOTE 3** Program the building alarm to read On Generator and for either Normally Open (default) or Normally Closed as required by the generator sensing output.
- NOTE 4** If installing interface wiring connections between standalone cabinets, conduit must be installed between cabinets.
- NOTE 5** Disconnect terminal block plugs from terminal blocks to wire plugs.
-

To Install wiring:

1. Verify the UPS system is turned off and all power sources are removed. See [Chapter 7 UPS Operating Instructions](#) for shutdown instructions.
2. If not already opened, open the front door by lifting the latch from the bottom and turning to the right (counterclockwise) and swing the door open.
3. If wiring the interface terminals from the bottom of the UPS, proceed to **Step 8**; otherwise, proceed to **Step 4**.
4. **Top Entry Wiring.** Remove the top interface entry conduit landing plates to drill or punch holes (see [Figure 22](#)).
5. Reinstall the interface entry plates and install the conduit.
6. Route the UPS building alarm interface wiring through the top interface entry conduit landing plates to the UPS building alarm terminals. See [Figure 22](#) for wiring access information, and [Figure 27](#) and [Figure 28](#) for UPS interface terminal locations.
7. Proceed to **Step 13**.
8. **Bottom Entry Wiring.** Remove the bottom interface entry conduit landing plates to drill or punch holes (see [Figure 29](#)).
9. Reinstall the interface entry plates and install the conduit.
10. Route the UPS building alarm interface wiring through the bottom interface entry conduit landing plates to the bottom access interface wiring channel along the inside of the front door.
11. Route the wiring along the interface wiring channel to the UPS building alarm terminals. See [Figure 27](#) and [Figure 28](#) for UPS interface terminal locations.
12. Secure the wiring to the wire tie anchors provided (see [Figure 30](#)) using Zip ties.
13. Connect the building alarm interface wiring to the building alarm terminals. See paragraph [3.2.4 UPS System Interface Wiring Preparation](#) and [Table 14](#) for wiring and termination requirements, and [Figure 31](#) for terminal assignments.
14. If wiring external parallel CAN connections, proceed to paragraph [4.10.5 Installing External Parallel CAN Control Wiring and Connections](#); if wiring external parallel pull chain connections, proceed to paragraph [4.10.6 Installing External Parallel Pull Chain Control Wiring and Connections](#); if wiring Minislot connections, proceed to paragraph [4.10.7 Installing Minislot Interface Connections](#); if wiring REPO connections, proceed to paragraph [4.11 Installing a REPO Switch](#); otherwise, proceed to **Step 15**.

15. Close the UPS outside door and secure the latch.

4.10.5 Installing External Parallel CAN Control Wiring and Connections



NOTE 1 If installing interface wiring connections between standalone cabinets, conduit must be installed between each cabinet.

NOTE 2 Disconnect terminal block plugs from terminal blocks to wire plugs.

To install wiring:

1. Verify the UPS system is turned off and all power sources are removed. See [Chapter 7 UPS Operating Instructions](#) for shutdown instructions.
2. If not already opened, open the front door by lifting the latch from the bottom and turning to the right (counterclockwise) and swing the door open.
3. If wiring the external parallel CAN connections using the inter-cabinet wiring access pass-through (line-up-and-match configurations), proceed to **Step 4**; if wiring the external parallel CAN connections using bottom entry access, proceed to **Step 6**; if wiring the external parallel CAN connections using top entry access, proceed to **Step 12**.
4. **Pass-through Wiring.** Route the external parallel CAN control wiring between UPS cabinets through the top UPS inter-cabinet wiring access pass-through to the UPS external parallel terminals. See [Figure 24](#) for UPS wiring access information, and [Figure 27](#) and [Figure 28](#) for UPS interface terminal locations.
5. Proceed to **Step 15**.
6. **Bottom Entry Wiring.** Remove the bottom interface entry conduit landing plate to drill or punch holes (see [Figure 29](#)).
7. Reinstall the interface entry plate and install the conduit.
8. Route the external parallel CAN control wiring through the bottom interface entry conduit landing plate to the bottom access interface wiring channel along the inside of the front door.
9. Route the wiring along the interface wiring channel to the UPS external parallel terminals. See [Figure 27](#) and [Figure 28](#) for UPS interface terminal locations.
10. Secure the wiring to the wire tie anchors provided (see [Figure 30](#)) using Zip ties.
11. Proceed to **Step 15**.
12. **Top Entry Wiring.** Remove the top interface entry conduit landing plate to drill or punch holes (see [Figure 22](#)).
13. Reinstall the interface entry plate and install the conduit.
14. Route the external parallel CAN control wiring through the top interface entry conduit landing plate to the UPS external parallel terminals. See [Figure 22](#) for wiring access information and [Figure 27](#) and [Figure 28](#) for UPS interface terminal locations.
15. Connect the external parallel CAN wiring to the CAN terminals. See paragraph [3.2.4 UPS System Interface Wiring Preparation](#), [Table 17](#), and [Table 18](#) for wiring and termination requirements, and [Figure 36](#) and [Figure 37](#) for wiring information and terminal assignments.
16. If wiring external parallel pull chain connections, proceed to paragraph [4.10.6 Installing External Parallel Pull Chain Control Wiring and Connections](#); if wiring Minislot connections, proceed to paragraph [4.10.7 Installing Minislot Interface Connections](#); if wiring REPO connections, proceed to paragraph [4.11 Installing a REPO Switch](#); otherwise, proceed to **Step 17**.
17. Close the UPS outside door and secure the latch.

Table 17. External Parallel CAN and Pull Chain Connections

External Parallel Terminal Block	Name	Description
1	Pull Chain	External parallel pull chain connections between UPSs.
2	Pull Chain Ground	
3	CAN H In	External parallel CAN input connections from previous UPS.
4	CAN L In	
5	Ground	
6	Earth	Not Used
7	CAN H Out	External parallel CAN output connections to next UPS.
8	CAN L Out	
9	Ground	
10	Earth	Not Used

Table 18. External Parallel CAN and Pull Chain Terminal Block Terminations

Terminal Function	Recommended Minimum Wire Size	Size of Pressure Termination	Tightening Torque Nm (lb in)	Type Screw	Comments
CAN	#18 AWG	#26–#16	0.4 (3.5) - 0.8 (7.1)	Slotted	Use shielded twisted-pair wires with drain wire for each input and return or common. Strip wire insulation back 10 millimeters to wire terminal blocks.
Pull Chain		#26–#16	0.4 (3.5) - 0.8 (7.1)	Slotted	Use twisted-pair wires for each input and return or common. Strip wire insulation back 10 millimeters to wire terminal blocks.

Figure 36. External Parallel CAN Wiring

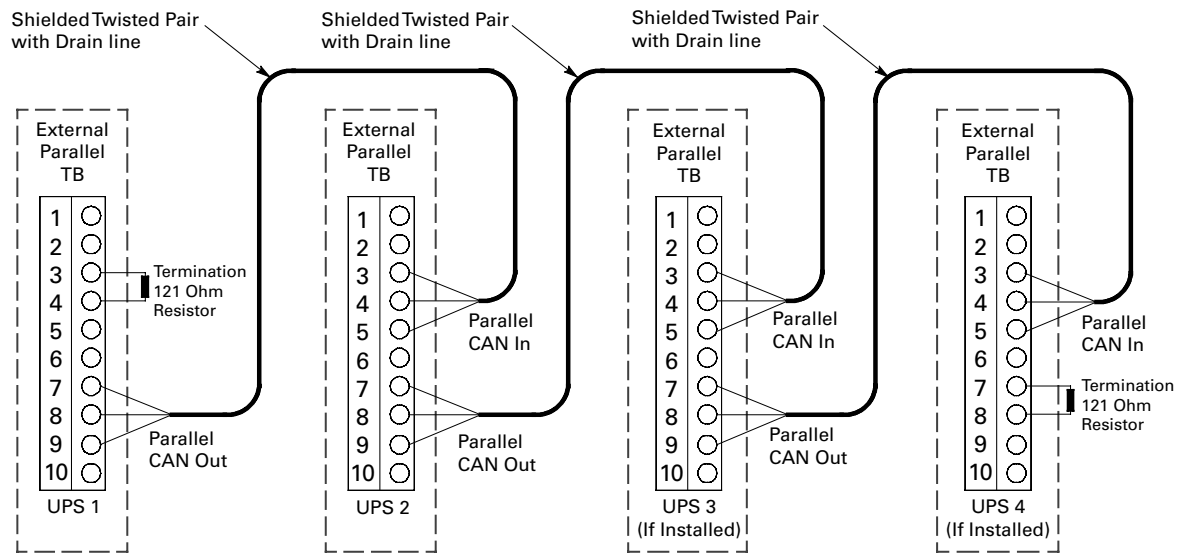

NOTE 1 External parallel CAN connections between UPS cabinets require shielded twisted pair wire with drain wire.



NOTE 2 Terminations are 121 ohm 1% resistors installed in the terminal block in the first and last UPS.

Figure 37. External Parallel Terminal Block

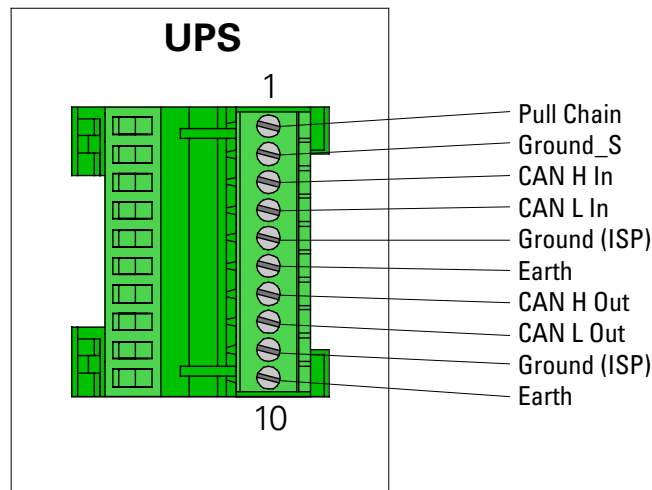

External Parallel Terminal Block

4.10.6 Installing External Parallel Pull Chain Control Wiring and Connections

NOTE 1 A UPS building alarm input is used to indicate an open MOB.

NOTE 2 Any pair of unused building alarm terminals may be used for the MOB Aux 1 connections.



NOTE 3 Program the MOB building alarm to read MOB open and for normally closed contacts.

NOTE 4 If installing interface wiring connections between standalone cabinets, conduit must be installed between cabinets.

NOTE 5 Disconnect terminal block plugs from terminal blocks to wire plugs.

To install wiring:

1. Verify the UPS system is turned off and all power sources are removed. See [Chapter 7 UPS Operating Instructions](#) for shutdown instructions.
2. If not already opened, open the front door by lifting the latch from the bottom and turning to the right (counterclockwise) and swing the door open.
3. If wiring the external parallel pull chain connections using the inter-cabinet wiring access pass-through (line-up-and-match configurations), proceed to **Step 4**; if wiring the external parallel pull chain connections using bottom entry access, proceed to **Step 6**; if wiring the external parallel pull chain connections using top entry access, proceed to **Step 12**.
4. **Pass-through Wiring.** Route the external parallel pull chain control wiring between UPS cabinets through the top UPS inter-cabinet wiring access pass-through to the UPS external parallel terminals. See [Figure 24](#) for UPS wiring access information, and [Figure 27](#) and [Figure 28](#) for UPS interface terminal locations.
5. Proceed to **Step 15**.
6. **Bottom Entry Wiring.** Remove the bottom interface entry conduit landing plate to drill or punch holes (see [Figure 29](#)).
7. Reinstall the interface entry plate and install the conduit.
8. Route the external parallel pull chain control wiring through the bottom interface entry conduit landing plate to the bottom access interface wiring channel along the inside of the front door.
9. Route the wiring along the interface wiring channel to the UPS external parallel and building alarm terminals. See [Figure 27](#) and [Figure 28](#) for UPS interface terminal locations.
10. Secure the wiring to the wire tie anchors provided (see [Figure 30](#)) using Zip ties.
11. Proceed to **Step 15**.
12. **Top Entry Wiring.** Remove the top interface entry conduit landing plate to drill or punch holes (see [Figure 22](#)).
13. Reinstall the interface entry plate and install the conduit.
14. Route the external parallel pull chain control wiring through the top interface entry conduit landing plate to the UPS external parallel and building alarm terminals. See [Figure 22](#) for wiring access information and [Figure 27](#) and [Figure 28](#) for UPS interface terminal locations.
15. Connect the external parallel pull chain wiring to the pull chain and building alarm terminals. See paragraph [3.2.4 UPS System Interface Wiring Preparation](#), [Figure 22](#), and [Table 17](#) for external parallel terminal block wiring and termination requirements, and [Figure 37](#) and [Figure 38](#) for wiring information and terminal assignments.

16. If wiring Minislot connections, proceed to paragraph [4.10.7 Installing Minislot Interface Connections](#); if wiring REPO connections, proceed to paragraph [4.11 Installing a REPO Switch](#); otherwise, proceed to **Step 17**.
17. Close the UPS outside door and secure the latch.

Figure 38. External Parallel Pull Chain Wiring

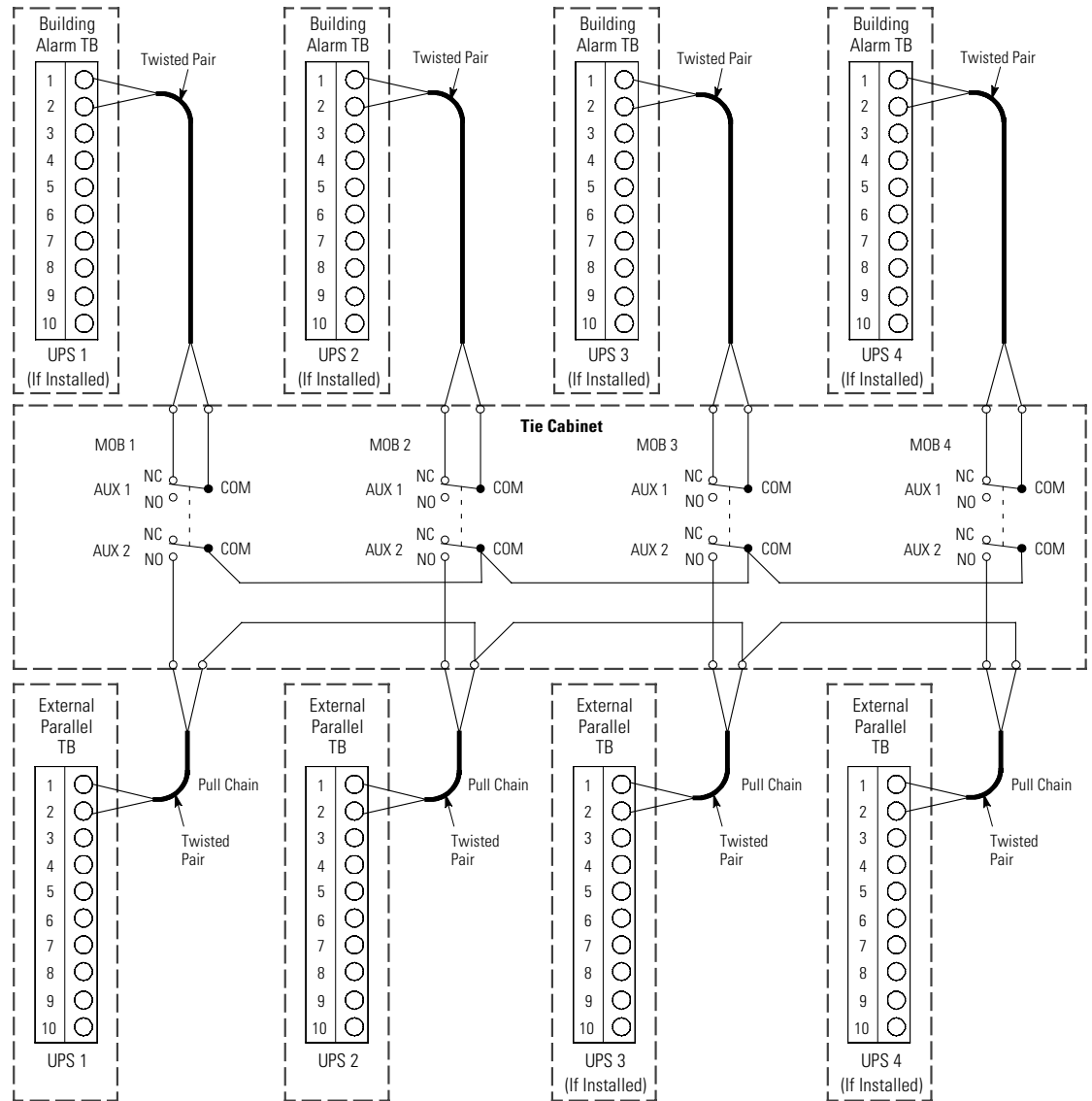

4.10.7 Installing Minislot Interface Connections

- NOTE 1** LAN drop for use with Minislot cards must be provided by the customer.
-  **NOTE 2** When installing interface wiring connections, conduit must be installed between each device and the UPS cabinet.
- NOTE 3** Remove the cabinet stiffener bar (see [Interface Terminal Detail](#)) before installing or removing Minislot cards. Reinstall the bar after the procedure is completed.
-

For installation and setup of a Minislot card, contact an Eaton service representative (see paragraph [1.9 Getting Help](#)).

To install wiring:

1. If not already installed, install the LAN drop.
2. If not already opened, open the front door by lifting the latch from the bottom and turning to the right (counterclockwise) and swing the door open.
3. If wiring a Minislot card from the bottom of the UPS, proceed to **Step 8**; otherwise, proceed to **Step 4**.
4. Remove the top interface entry conduit landing plate to drill or punch holes (see [Figure 22](#)).
5. Reinstall the interface entry plate and install the conduit.
6. Route the Minislot card interface wiring through the top interface entry conduit landing plate to the Minislot card terminals. See [Figure 22](#) for wiring access information, and [Figure 27](#) and [Figure 28](#) for Minislot card locations.
7. Proceed to **Step 13**.
8. Remove the bottom interface entry conduit landing plate to drill or punch holes (see [Figure 29](#)).
9. Reinstall the interface entry plate and install the conduit.
10. Route the Minislot card interface wiring through the bottom interface entry conduit landing plate to the bottom access interface wiring channel along the inside of the front door.
11. Route the wiring along the interface wiring channel (see [Figure 29](#)) to the Minislot card terminals. See [Figure 27](#) and [Figure 28](#) for Minislot card locations.
12. Secure the wiring to the wire tie anchors provided (see [Figure 30](#)) using Zip ties.
13. Install the LAN and other cables to the appropriate Minislot cards. Refer to the manual supplied with the Minislot card for terminal assignments.
14. Refer to the manual supplied with the Minislot card for operator instructions.
15. If wiring REPO connections, proceed to paragraph [4.11 Installing a REPO Switch](#); otherwise, proceed to **Step 16**.
16. Close the UPS outside door and secure the latch.

4.11 Installing a REPO Switch

A latching-type Remote Emergency Power-off (REPO) switch can be used in an emergency to shut down the UPS and remove power to the critical load from a location away from where the UPS is installed. [Figure 39](#) shows a REPO switch.

-
- NOTE 1** Before installing a REPO switch, verify that the UPS was installed according to the instructions in paragraphs [Preliminary Installation Information](#) through [External AC Power Wiring Installation](#).
- NOTE 2** When installing the REPO switch, you must install conduit between the device and the UPS cabinet for wiring the switch.
- NOTE 3** The REPO switch must be a Normally-open or Normally-closed latching-type switch not tied into any other circuits.
-  **NOTE 4** This procedure is intended for installing the Eaton-supplied REPO switch. If installing another manufacturer's switch, use this procedure, [Normally-Open REPO Switch Wiring](#) and [Normally-Closed REPO Switch Wiring](#) as a guide.
- NOTE 5** The REPO switch wiring must be in accordance with NEC Article 725 Class 2 requirements.
- NOTE 6** Disconnect terminal block plugs from terminal blocks to wire plugs.
-

To Install a REPO switch:

1. Verify the UPS system is turned off and all power sources are removed. See [Chapter 7 UPS Operating Instructions](#) for shutdown instructions.
2. Securely mount the REPO switch. Recommended locations include operator's consoles or near exit doors. See [Figure 14](#) for enclosure dimensions and wiring knockouts.
3. If not already opened, open the front door by lifting the latch from the bottom and turning to the right (counterclockwise) and swing the door open.
4. If wiring the REPO terminals from the bottom of the UPS, proceed to **Step 9**; otherwise, proceed to **Step 5**.
5. Remove the top interface entry conduit landing plate to drill or punch holes (see [Figure 22](#)).
6. Reinstall the interface entry plate and install the conduit.
7. Route the REPO wiring through the top interface entry conduit landing plate to the REPO terminals. See [Figure 22](#) for wiring access information, and [Figure 27](#) and [Figure 28](#) for UPS interface terminal locations.
8. Proceed to **Step 14**.
9. Remove the bottom interface entry conduit landing plate to drill or punch holes (see [Figure 29](#)).
10. Reinstall the interface entry plate and install the conduit.

Figure 39. REPO Switch

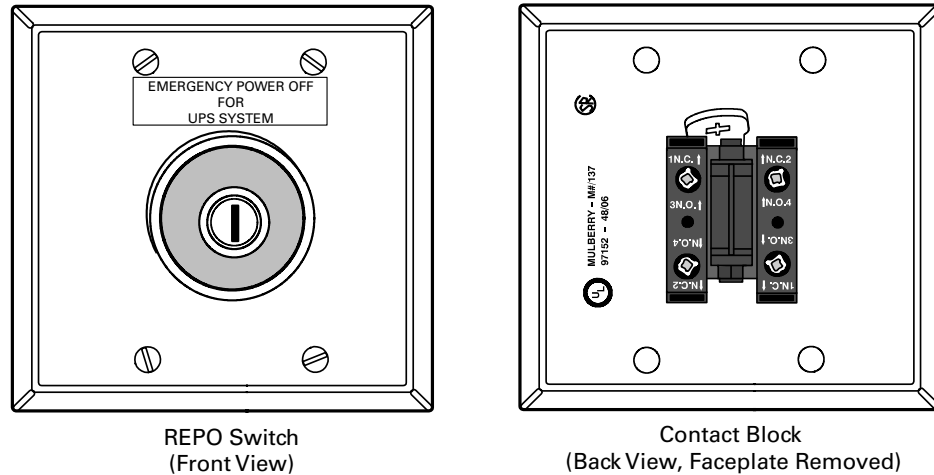

11. Route the REPO wiring through the bottom interface entry conduit landing plate to the bottom access interface wiring channel along the inside of the front door (see [Figure 29](#)).
12. Route the wiring along the interface wiring channel to the REPO terminals.
13. Secure the wiring to the wire tie anchors provided.
14. Connect the REPO wiring as shown in [Table 19](#) and [Figure 41](#) for a normally-open REPO, or [Table 20](#) and [Figure 42](#) for a normally-closed REPO. See paragraph [3.2.4 UPS System Interface Wiring Preparation](#) for wiring and termination requirements, and [Figure 40](#) for terminal assignments.
15. If using a normally-closed REPO switch, connect a jumper wire between pins 3 and 4 on the REPO terminal block.
16. If you are installing multiple REPO switches, wire additional switches in parallel with the first REPO.
17. If required, install wiring from the REPO switch to the trip circuitry of the upstream protective devices. A second contact block is provided on the REPO switch for this function (see [Figure 39](#)). The REPO switch wiring must be in accordance with NEC Article 725 Class 2 requirements.
18. Close the UPS outside door and secure the latch.

Figure 40. REPO Terminal Block Connector Assignments

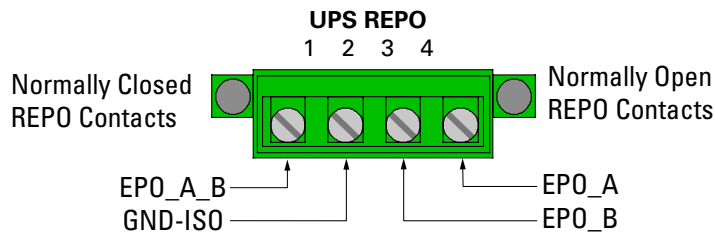
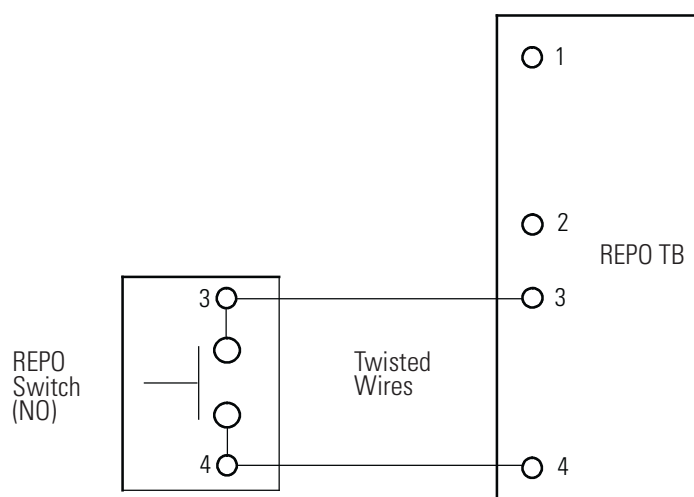

Table 19. Normally-Open REPO Connections and Wire Terminations

From REPO Station Switch Contact Block (Either Block)	UPS REPO Terminal	Name	Description	Recommended Minimum Wire Size	Size of Wire Termination	Tightening Torque
3 NO	3	EPO_A	Input: Normally-open dry contact used to activate UPS EPO from a remote switch	Twisted Pair Wires #18 AWG	#16-#30 AWG	2 lb in (0.22-0.25 Nm)
4 NO	4	EPO_B				

Figure 41. Normally-Open REPO Switch Wiring**Table 20. Normally-Closed REPO Connections and Wire Terminations**

From REPO Station Switch Contact Block (Either Block)	UPS REPO Terminal	Name	Description	Recommended Minimum Wire Size	Size of Wire Termination	Tightening Torque
3 NO	1	EPO_A_B	Input: Normally-closed dry contact used to activate UPS EPO from a remote switch	Twisted Pair Wires #18 AWG	#16-#30 AWG	2 lb in (0.22-0.25 Nm)
4 NO	2	GND-ISO				

Figure 42. Normally-Closed REPO Switch Wiring

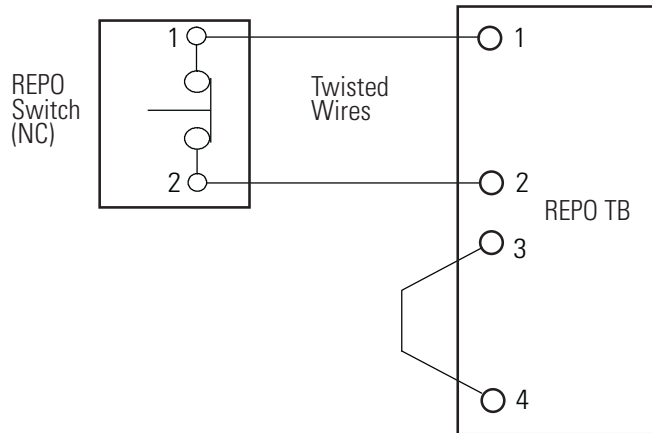

4.12 Initial Startup

Startup and operational checks for parallel systems or installations with accessory cabinets must be performed by an authorized Eaton Customer Service Engineer, or the warranty terms specified on the product's resources page become void. See [Chapter 11 Warranty](#) for details. This service is offered as part of the sales contract for the UPS. Contact an Eaton service representative in advance (usually a two-week notice is required) to reserve a preferred startup date.

4.13 Completing the Installation Checklist

The final step in installing the UPS system is completing the following Installation Checklist. This checklist ensures that you have completely installed all hardware, cables, and other equipment. Complete all items listed on the checklist to ensure a smooth installation. Make a copy of the Installation Checklist before filling it out, and retain the original.

After the installation is complete, an Eaton Customer Service Engineer must verify the operation of the UPS system and commission it to support the critical load. The service representative cannot perform any installation tasks other than verifying software and operating setup parameters. Service personnel may request a copy of the completed Installation Checklist to verify all applicable equipment installations have been completed.



NOTE

The Installation Checklist MUST be completed prior to starting the UPS system for the first time.

4.14 Installation Checklist

- All packing materials and restraints have been removed from each cabinet.
- The UPS cabinet is placed in its installed location.
- All conduits and cables are properly routed to the UPS and any ancillary cabinets.
- All power cables are properly sized and terminated.
- Battery cables are terminated on E4 (+) and E5 (-).
- Battery shunt trip signal wiring is connected from the UPS to the battery disconnect.
- Battery detect signal wiring is connected from the UPS to the battery disconnect.
- A ground conductor is properly installed.
- Building alarms and alarm relays are wired appropriately. (Optional)
- LAN drops are installed. (Optional)
- LAN connections have been completed. (Optional)
- The REPO device is mounted in its installed location and its wiring is terminated inside the UPS cabinet. (Optional)
- A jumper wire is connected between pins 3 and 4 on the REPO terminal block if using a normally-closed REPO switch. (Optional)
- All internal safety shields are installed.
- Accessories are mounted in installed locations and wiring is terminated inside the UPS cabinet. (Optional)
- Air conditioning equipment is installed and operating correctly.
- The area around the installed UPS system is clean and dust-free. (Eaton recommends that the UPS be installed on a level floor suitable for computer or electronic equipment.)
- Adequate workspace exists around the UPS and other cabinets.
- Adequate lighting is provided around all UPS equipment.
- A 120 Vac service outlet is located within 7.5m (25 ft) of the UPS equipment.
- Startup and operational checks are performed by an authorized Eaton Customer Service Engineer for parallel systems or installations with accessory cabinets.
- Visit www.eaton.com/pq/register to register your new Eaton UPS / Eaton UPS Accessory.

Notes

Chapter 5 Understanding UPS Operation

5.1 UPS System Overview

The Eaton 93PM UPS is a continuous-duty, solid-state, transformerless, three-phase, true online system that provides conditioned and uninterruptible AC power to the UPS system's output and critical load.

The basic system consists of a rectifier, battery converter, inverter, monitoring/operation control panel, integrated communication server, and digital signal processor (DSP) logic. [Figure 43](#) shows the main elements of the UPS system.

If utility power is interrupted or falls outside the parameters specified in **Chapter 10 Product Specifications**, the UPS uses a backup battery supply to maintain power to the critical load for a specified period of time or until the utility power returns. For extended power outages, the UPS allows you to either transfer to an alternative power system (such as a generator) or shut down your critical load in an orderly manner.

The emergency bypass consists of a continuous static switch, and bypass switchgear. The bypass switchgear is located in series with the static switch. The static switch is armed and ready during normal operation.

This unit is a three-wire device. The loss of a single input phase will be considered a complete loss of input power and discharge the battery to provide power to the load.

Figure 43. Main Elements of the UPS System

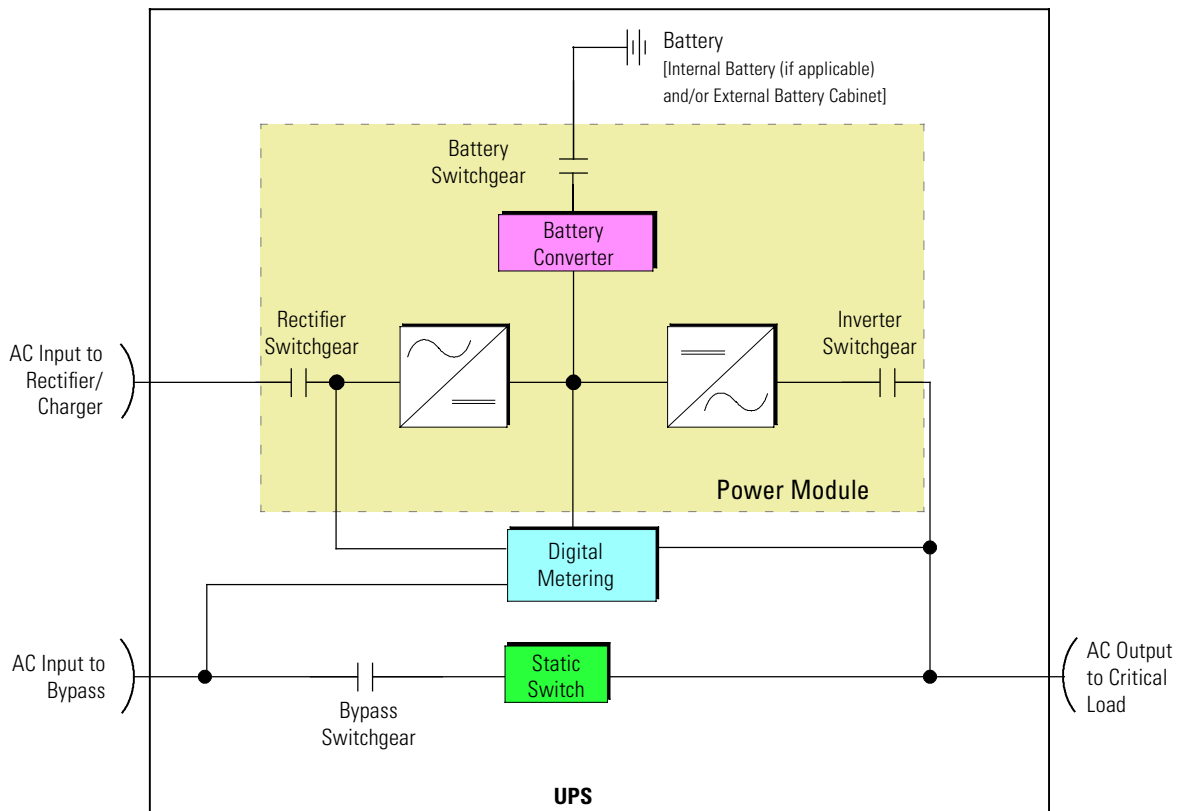

5.2 Single UPS

A single UPS operates independently to support an applied load from the inverter, providing conditioned and uninterruptible AC power to the critical load from the output of the module. During an outage, the inverter continues to operate, supporting power to the load from the battery supply. If the unit requires service, applied loads are transferred to the internal bypass either automatically or manually.

5.2.1 Modes

The Eaton 93PM UPS supports a critical load in four different modes of operation:

- In Energy Saver System (ESS) mode, commercial AC power is supplied directly to the critical load through the internal bypass and transfers automatically to Normal mode (double-conversion on demand) if an abnormal condition is detected. The battery charger also provides charging current for the battery, if needed.
- In Normal (double-conversion) mode, the critical load is supplied by the inverter, which derives its power from rectified utility AC power. In this mode, the battery charger also provides charging current for the battery, if needed.
- In Bypass mode, the critical load is directly supported by utility power. The battery charger also provides charging current for the battery, if needed.
- In Battery mode, the battery provides DC power, which maintains inverter operation. The battery supports the critical load.

The following paragraphs describe the differences in the UPS operating modes, using block diagrams to show the power flow during each mode of operation.

5.2.2 Energy Saver System Mode

When the UPS is operating in ESS mode, commercial AC power is supplied directly to the critical load through the internal bypass with the power module in a standby state. Surge protection and some filtering is also provided, ensuring that clean power is delivered to the load equipment. If a commercial power brownout, blackout, overvoltage, undervoltage, out-of-tolerance frequency condition occurs, or any other disturbance is detected in the incoming power, the system forward transfers to normal mode (double-conversion on demand). In case of a complete utility outage or if input power is outside the tolerances of the system, the UPS transfers to battery mode and continues to supply conditioned, clean power to the critical load. When the input line returns to normal operating range, the UPS returns to ESS operation. For charging batteries, the UPS will not enter ESS mode until charger output is 25% or less of maximum charger current.

When operating in ESS, the UPS detection and control algorithms continuously monitor incoming power quality and allow the fast engagement of power converters. Typical transition time to double conversion is less than two milliseconds, which is practically seamless. If the UPS detects a fault condition while operating in ESS, it is also able to detect and determine whether the fault is caused by the load or if it is upstream from the UPS. A fault at the bypass source results in an immediate switch over to the inverter. A fault in the utility switches the UPS out of Energy Saver System (ESS) mode while a fault in the load keeps the UPS in ESS mode.

When power conditions are within acceptable limits, the UPS operates as a high-efficiency, energy-saving system — providing surge protection for IT equipment and ensuring clean power is delivered to the critical load. Energy saver system increases system efficiency to 99% at 100% linear load and nominal Vin.

[Figure 44](#) shows the path of electrical power through the UPS system when the UPS is operating in Normal mode.

ESS mode is a normal operating mode, and not an alarm condition. While the UPS is in this mode, the NORMAL light on the front display will illuminate.

Figure 44. Path of Current Through the UPS in Energy Saver System Mode

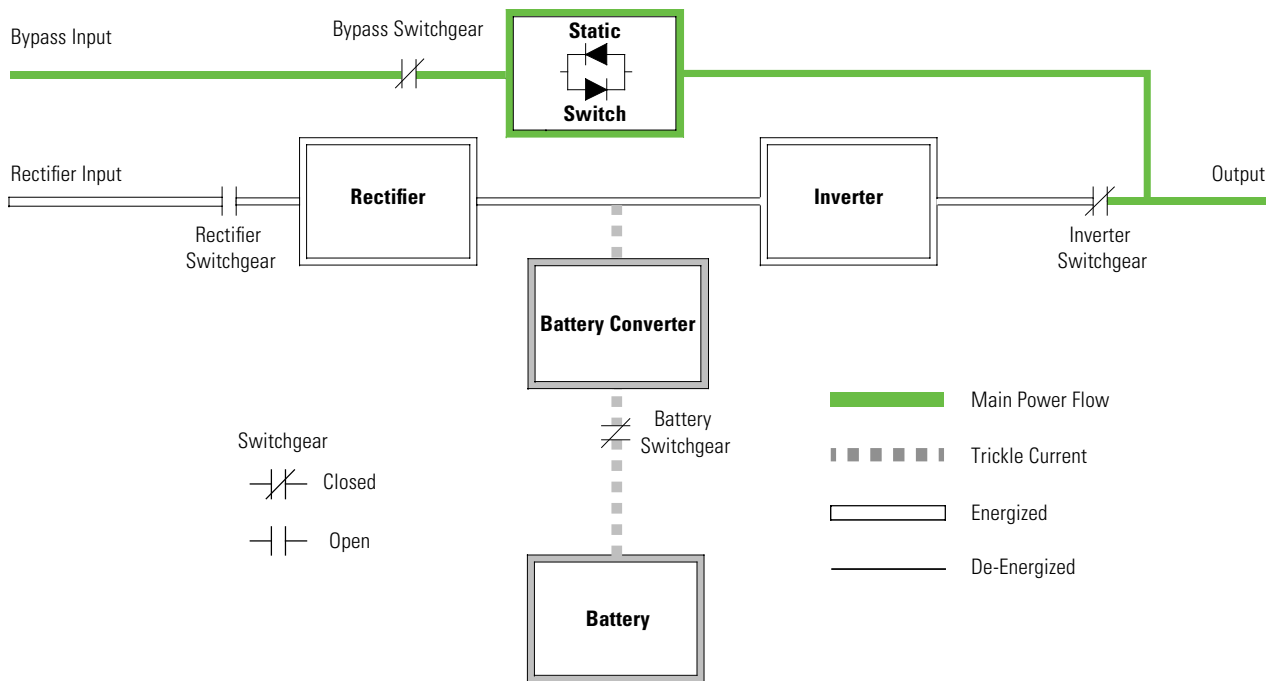

5.2.3 Normal Mode

During Normal mode, power for the system is derived from a utility input source through the rectifier switchgear. Three-phase AC input power is converted to DC using IGBT devices to produce a regulated DC voltage to the inverter. When the battery switchgear is closed the battery is charged directly from the regulated rectifier output through a buck or boost DC converter, depending on the system voltage and the size of the battery string attached to the unit.

Figure 45 shows the path of electrical power through the UPS system when the UPS is operating in Normal mode.

The battery converter derives its input from the regulated DC output of the rectifier and provides a bucked regulated DC voltage charge current to the battery. The battery is always connected to the UPS and ready to support the inverter should the utility input become unavailable.

The inverter produces a three-phase AC output to a customer's load without the use of a transformer. The inverter derives regulated DC from the rectifier and uses IGBT devices and pulse-width modulation (PWM) to produce a regulated and filtered AC output. The AC output of the inverter is delivered to the system output through the inverter switchgear.

If the utility AC power is interrupted or is out of specification, the UPS automatically switches to Battery mode to support the critical load without interruption. When utility power returns, the UPS returns to Normal mode.

If the UPS becomes overloaded or unavailable, the UPS switches to Bypass mode. The UPS automatically returns to Normal mode when the overload condition is cleared and system operation is restored within specified limits.

If the UPS suffers an internal failure and is configured for capacity, it switches automatically to Bypass mode and remains in that mode until the failure is corrected and the UPS is back in service.

Figure 45. Path of Current Through the UPS in Normal Mode

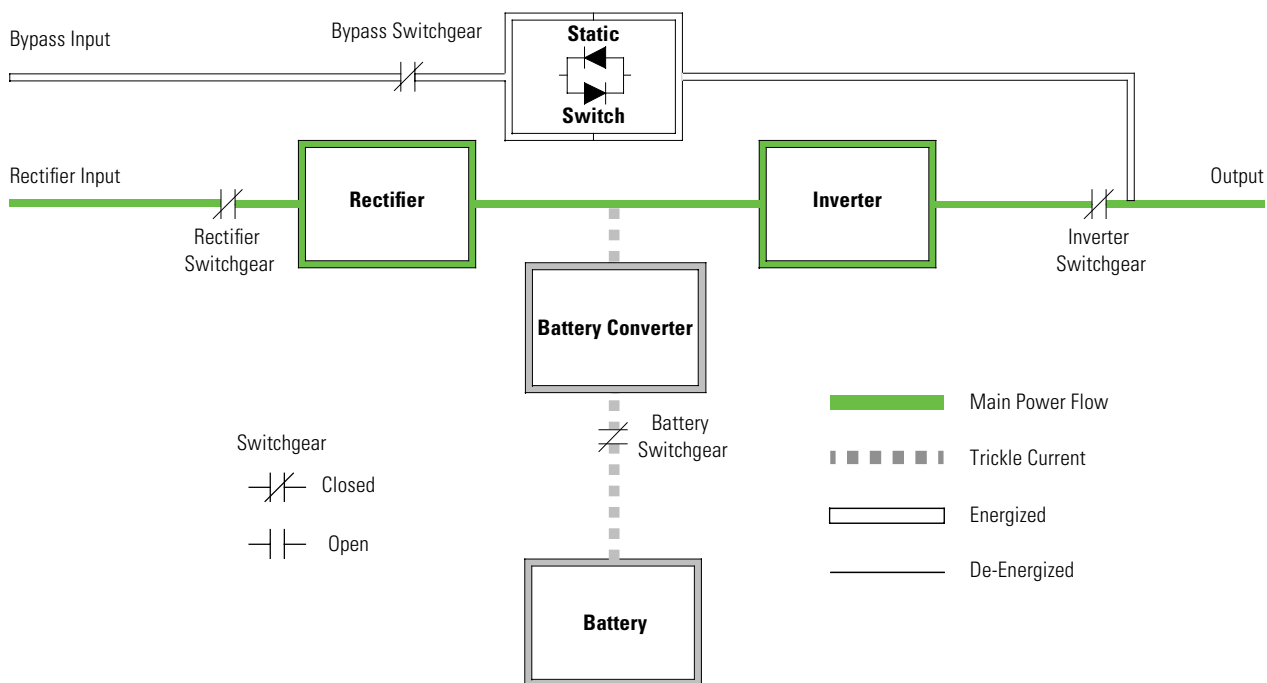

5.2.4 Bypass Mode



The critical load is not protected from voltage or frequency fluctuations or power outages while the UPS is in Bypass mode.

The UPS automatically switches to Bypass mode if it detects an overload, load fault, or internal failure (if configured for capacity). If configured for redundancy (N+1) the UPS would remain on line in Normal mode if one UPM failed. The UPS can also be transferred from Normal mode to Bypass mode manually. The bypass source supplies the commercial AC power to the load directly. [Figure 46](#) shows the path of electrical power through the UPS system when operating in Bypass mode.

In Bypass mode, the output of the system is provided with three-phase AC power directly from the system input. While in this mode, the output of the system is not protected from voltage or frequency fluctuations or power outages from the source. Some power line filtering and surge protection is provided to the load but no active power conditioning or battery support is available to the output of the system in the Bypass mode of operation.

The internal bypass is comprised of a solid-state, silicon-controlled rectifier (SCR) continuous duty static switch, and bypass switchgear. The static switch is used instantaneously anytime the inverter is unable to support the applied load. The continuous static switch is wired in series with the bypass switchgear, and together they are wired in parallel with the rectifier and inverter.

The static switch, being an electronically-controlled device, can be turned on immediately to pick up the load from the inverter while the inverter switchgear opens to isolate the inverter. The bypass switchgear is normally closed, ready to support the static switch unless the bypass input source becomes unavailable.

If the UPS transfers to Bypass mode from Normal mode due to any reason other than operator intervention, the UPS automatically attempts to transfer back to Normal mode (up to three times within a ten minute period). The fourth transfer attempt locks the critical load to the bypass source and requires operator intervention to transfer.

Figure 46. Path of Current Through the UPS in Bypass Mode

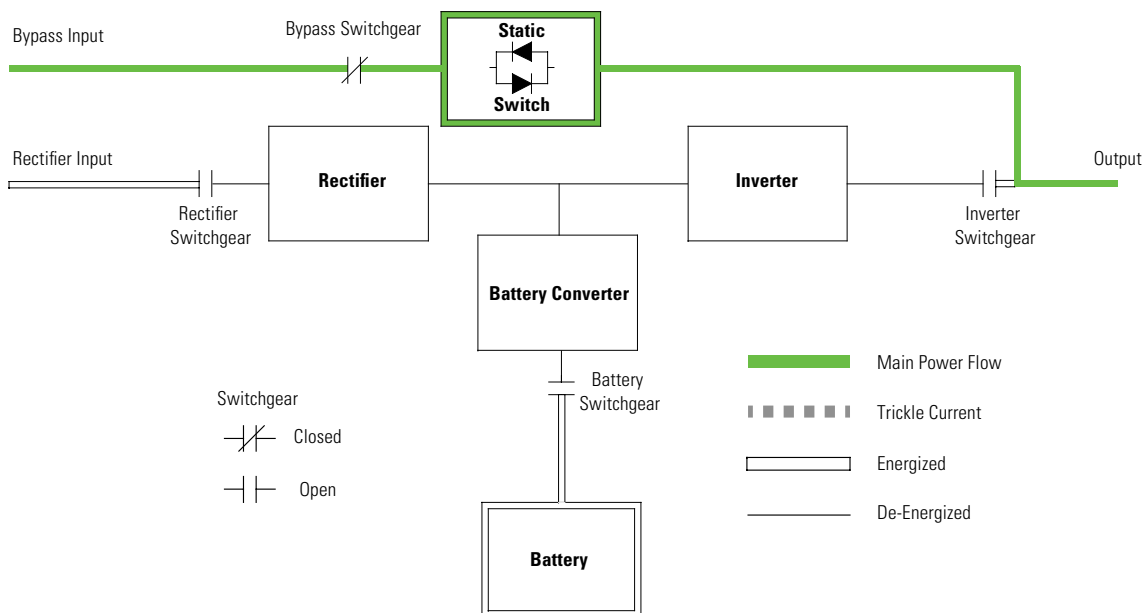

5.2.5 Battery Mode

The UPS automatically transfers to Battery mode if a utility power outage occurs, or if the utility power does not conform to specified parameters. In Battery mode, the battery provides emergency DC power that the inverter converts to AC power.

Figure 47 shows the path of electrical power through the UPS system when operating in Battery mode.

During a utility power failure, the rectifier no longer has an AC utility source from which to supply the DC output voltage required to support the inverter. The rectifier switchgear opens and the battery instantaneously supplies energy to the battery converter. The converter boosts the voltage so that the inverter can support the customer's load without interruption. If bypass is common with the rectifier input, the bypass switchgear also opens. The opening of the rectifier and bypass switchgear prevent system voltages from bleeding backwards through the static switch and rectifier snubber components to the utility source.

If the input power fails to return or is not within the acceptance windows required for normal operation, the battery continues discharging until a DC voltage level is reached where the inverter output can no longer support the connected loads. When this event occurs, the UPS issues another set of audible and visual alarms indicating SHUTDOWN IMMINENT. Unless the rectifier has a valid AC input soon, the output can be supported for only two minutes before the output of the system shuts down.

If at any time during the battery discharge the input power becomes available again, the rectifier and the bypass switchgear close and the rectifier begins to supply DC current to the converter and inverter. At this point, the unit returns to Normal mode. Depending on the total load and the duration of the battery discharge, battery current limit alarms may be seen for a short time due to the current required to recharge the battery.

Figure 47. Path of Current Through the UPS in Battery Mode

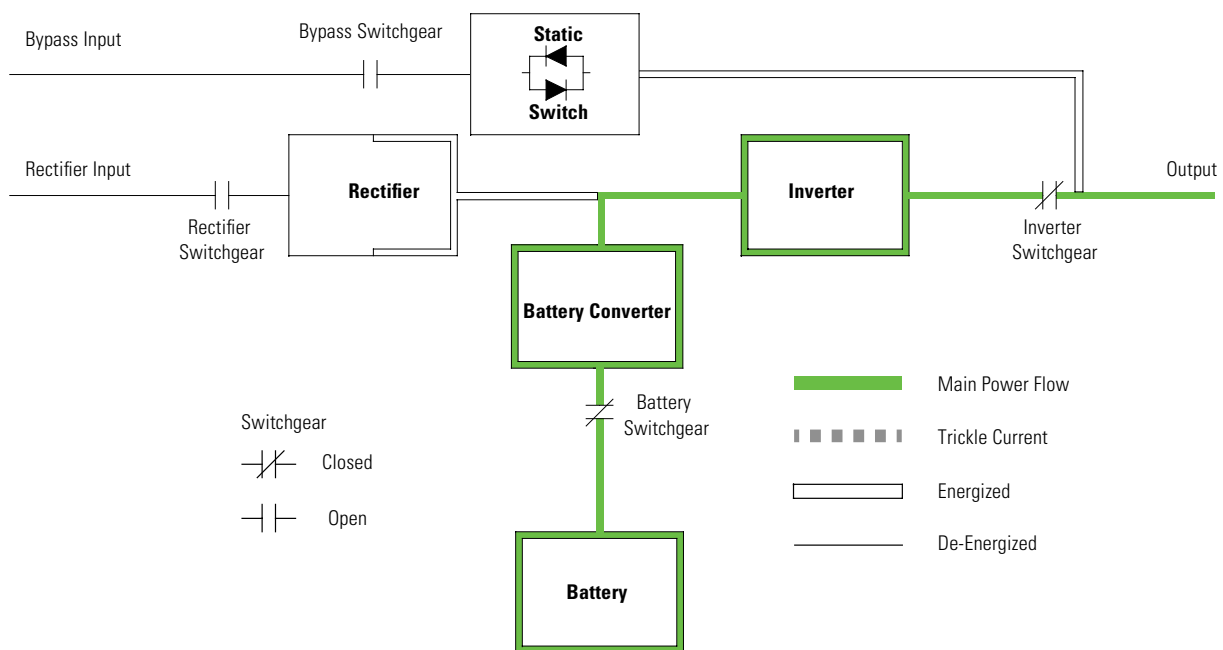

Chapter 6 UPS Oneline Schematics

The system oneline drawings in this section show the simplified internal structure of the UPS, battery supply, and basic maintenance bypass.

Oneline Drawing	UPS Model	System Type
See Figure 48	93PM UPS	Reverse transfer UPS with up to 3 UPMs with external battery
See Figure 49	93PM UPS with a 2 Breaker SIAC-B	Reverse transfer UPS with up to 3 UPMs with two breaker bypass and external battery
See Figure 50	93PM UPS with a 3 Breaker SIAC-B	Reverse transfer UPS with up to 3 UPMs with three breaker bypass and external battery
See Figure 51	93PM UPS with a 4 Breaker SIAC-B	Reverse transfer UPS with up to 3 UPMs with four breaker bypass and external battery

Figure 48. Eaton 93PM UPS System Online

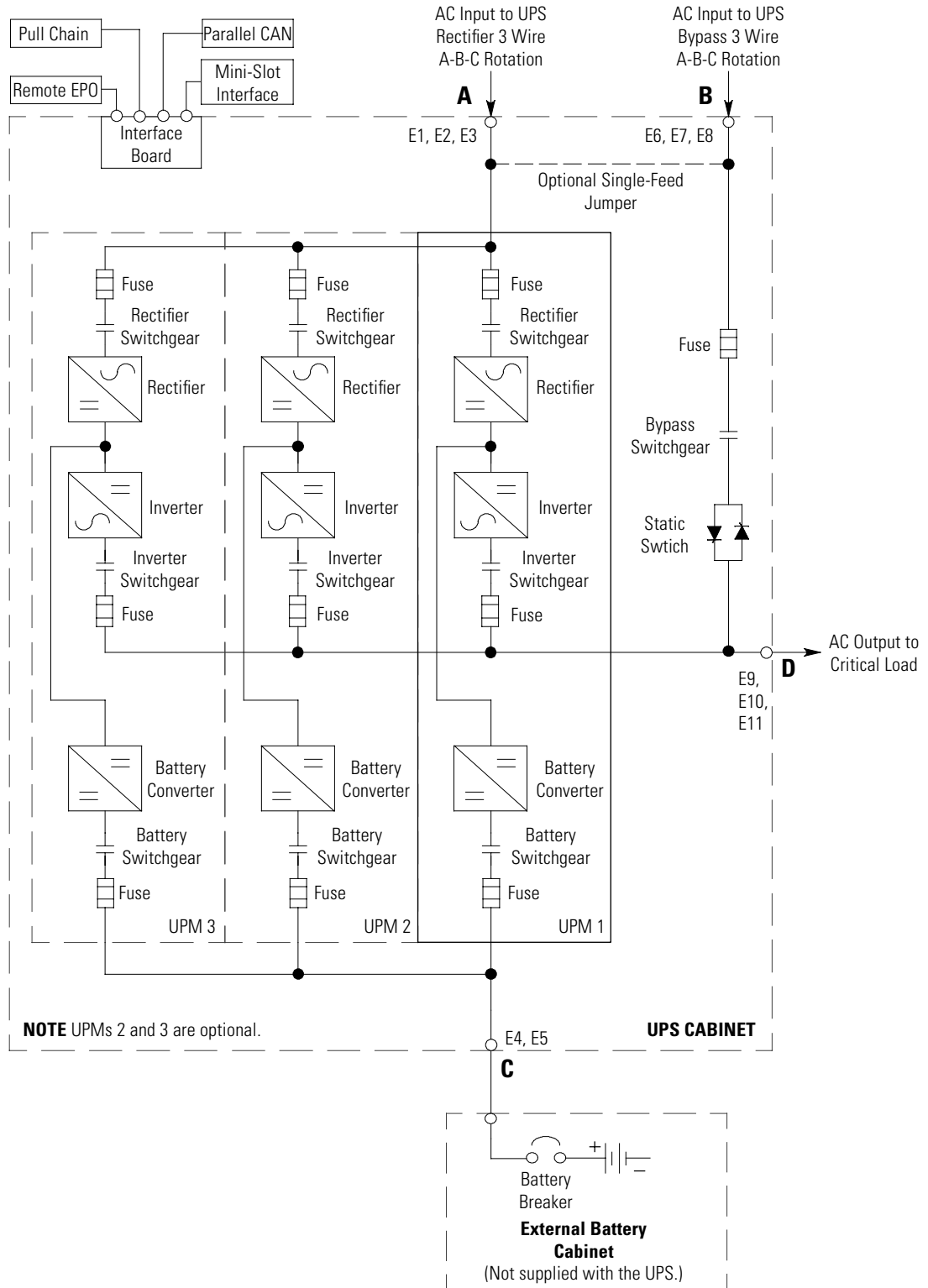

Figure 49. Eaton 93PM UPS System with Two-Breaker Bypass Online

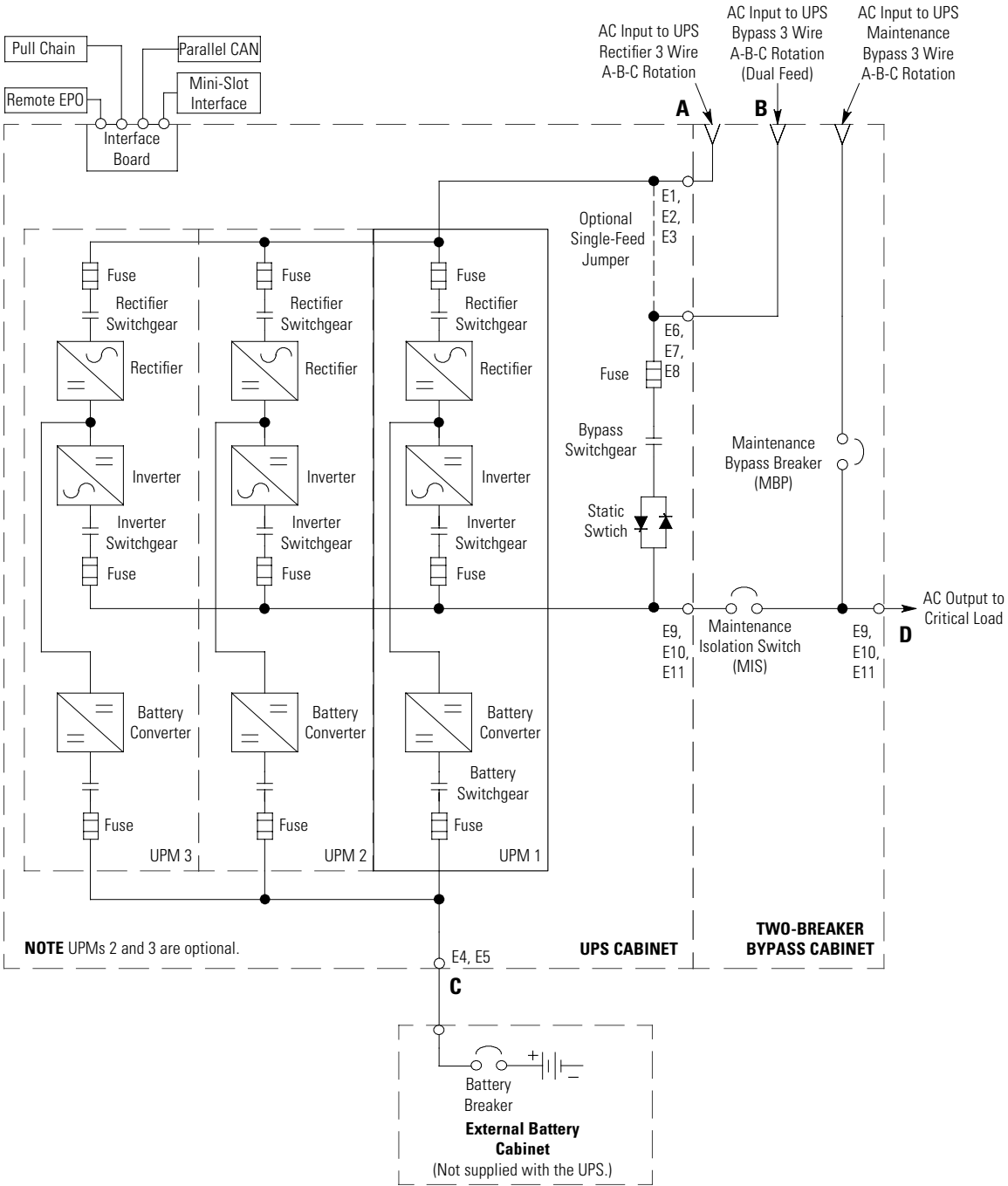

Figure 50. Eaton 93PM UPS System with Three-Breaker Bypass Online

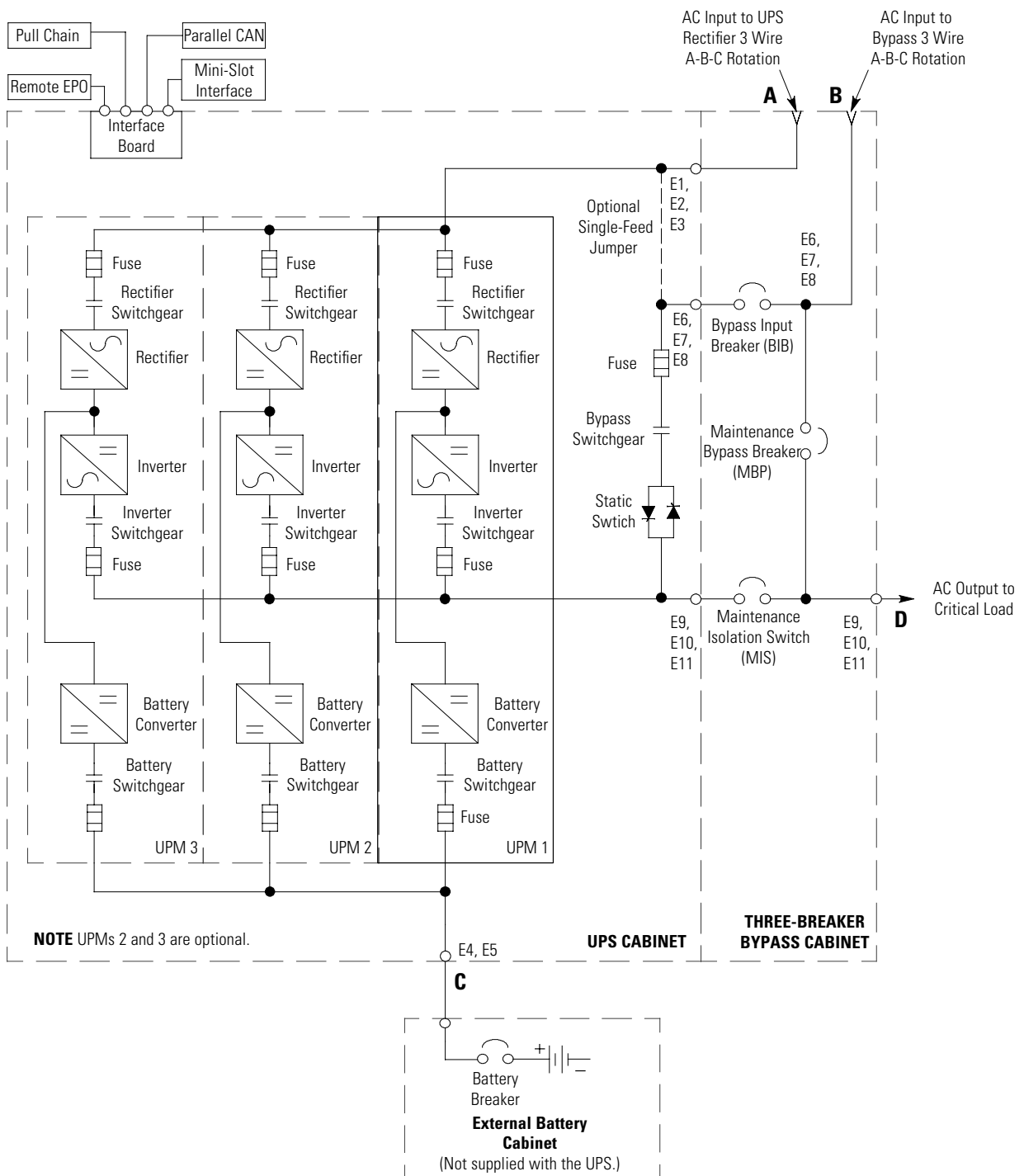
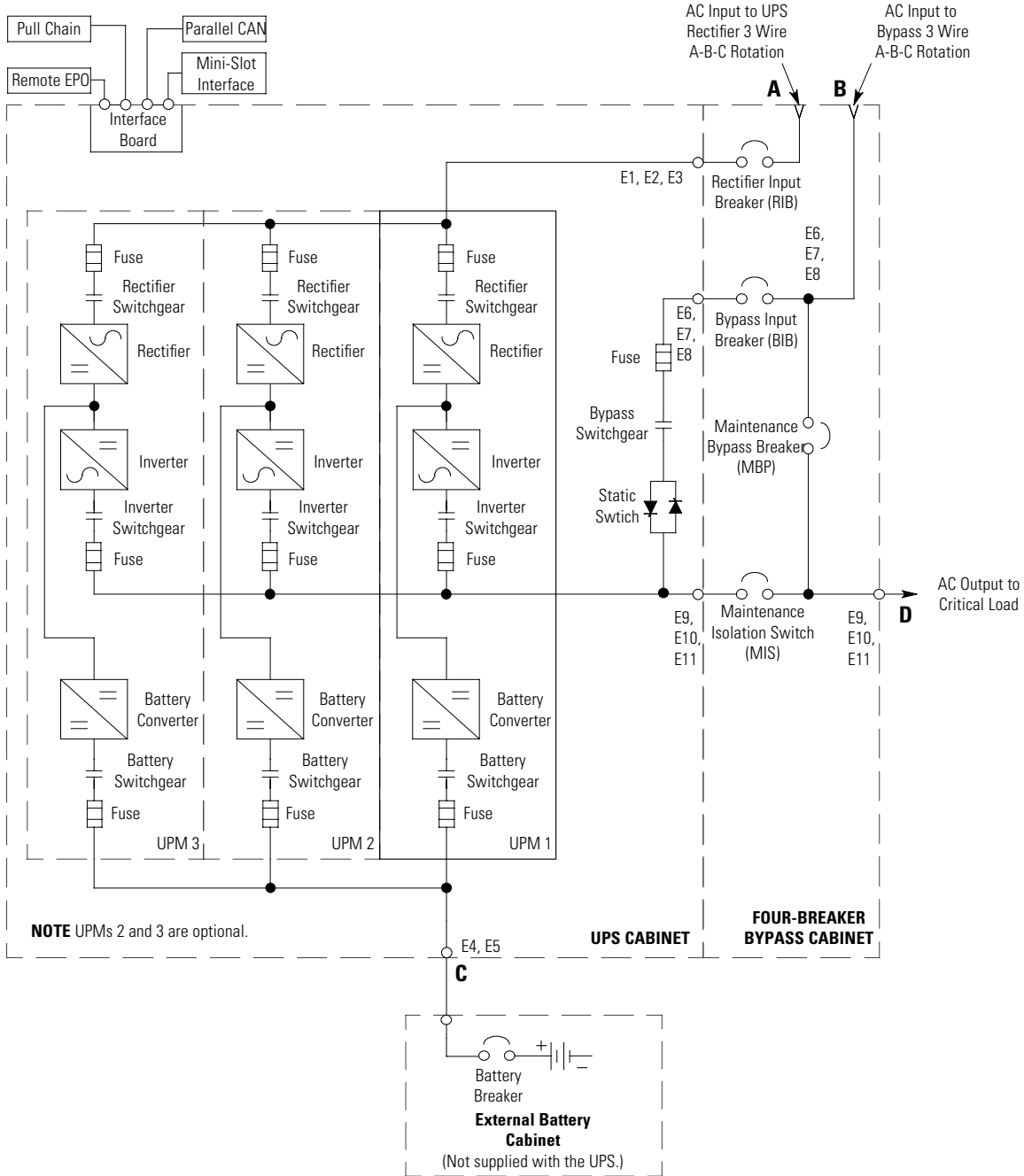

Figure 51. Eaton 93PM UPS System with Four-Breaker Bypass Online



Chapter 7 UPS Operating Instructions

This section describes how to operate the UPS.

-
- NOTE 1** Before starting the UPS, ensure all installation tasks are complete and a preliminary startup has been performed by authorized service personnel. The preliminary startup verifies all electrical interconnections to ensure the installation was successful and the system operates properly.
- NOTE 2** Read this section of the manual and have thorough knowledge of UPS operation before attempting to operate any of the controls.
-

7.1 UPS Controls and Indicators

The controls and indicators identified and described in this section are used to set up, control, and monitor UPS operation. [Figure 52](#) shows the control panel location on the front door of the UPS. For a description of the UPS control panel functions, and how to control and monitor UPS operation., see paragraph [7.2 Using the Control Panel](#).

Figure 52. UPS Controls and Indicators

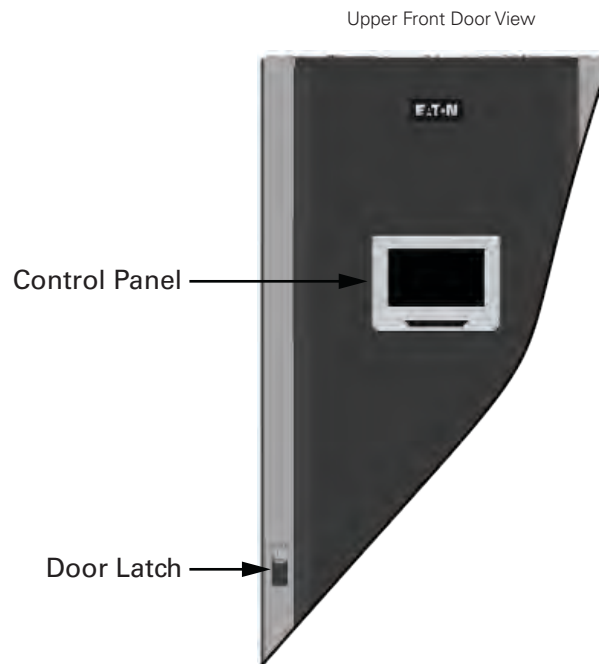

7.2 Using the Control Panel

The following paragraphs describe the UPS control panel, including controls and indicators, and how to monitor UPS operation. The control panel is shown in [Figure 53](#).

Figure 53. UPS Control Panel

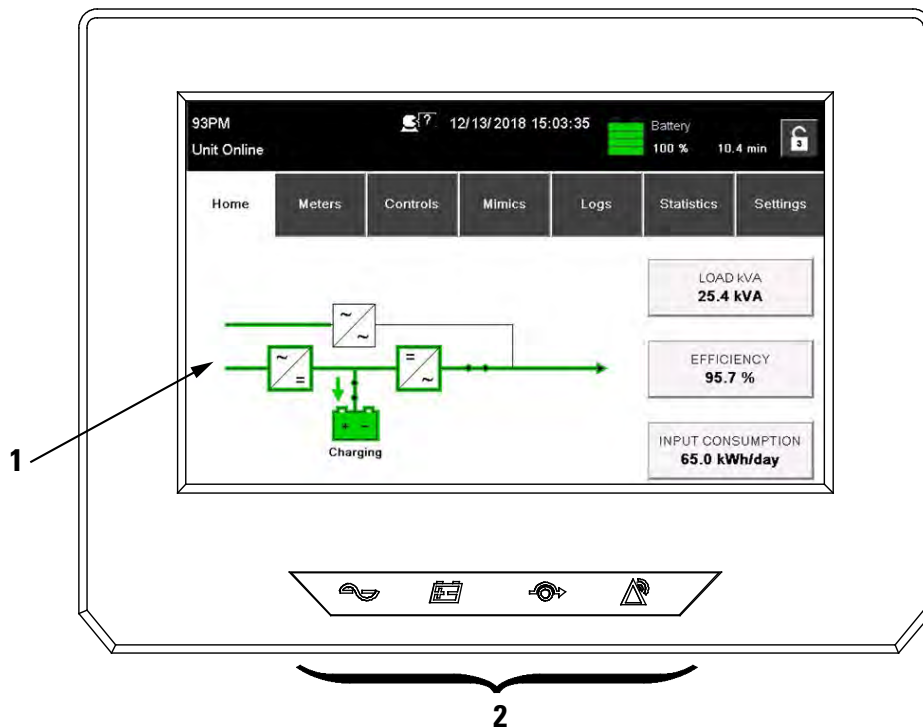

The control panel consists of:

- A color liquid crystal touch screen display (1).
- A horizontal row of status indicators (2). See paragraph [7.2.1 Status Indicators](#).

The following paragraphs describe using the UPS control panel to monitor the UPS. See paragraph [7.3 Single UPS Operation](#) for use of the operational controls.





When the unit powers up, the screen displays the as shown in [Figure 53](#).

7.2.1 Status Indicators

The four symbols on the bottom of the control panel are status indicators. These colored light emitting diode (LED) lamps work with the alarm horn to provide the operating status of the UPS.

[Table 21](#) describes the status indicators.

Table 21. Status Indicators

Indicator	Status	Description
 Green	On	The UPS is in Double Conversion mode. The power module is supplying power to the critical load.
	Off	The UPS is turned off.
 Yellow	On	The UPS is in Battery mode. Because Battery mode is a normal condition of the UPS, the normal indicator also remains illuminated.
 Yellow	On	The UPS is in Bypass mode. The critical load is supported by the bypass source. The normal indicator is not illuminated when the system is in Bypass mode.
 Red	On	The UPS has an active alarm and requires immediate attention. The LCD shows the highest priority active alarms. All alarms are accompanied by an audible horn. To silence the horn, touch any control panel button. The Alarm indicator may be illuminated along with other indicators.
	Flashing	There is a new UPS alarm condition. The indicator flashes until acknowledged by touching any control panel button once.

7.2.2 System Events

When the UPS system is running in Double Conversion mode, it continually monitors itself and the incoming utility power. In Battery or Bypass modes, the UPS may issue alarms to let you know exactly what event caused the change from Double Conversion mode. System events on the UPS can be indicated by horns, lights, messages, or all three.

Select the **LOGS** tab from the navigation bar on main menu screen to display the active events screen. This screen shows any currently active alarms, notices, or commands. For more information on using the events screen, see paragraph [7.2.6 Display Menu Operation](#).

- **System Event Horns** – The system event horn beeps to alert an operator that an event needing attention is taking place. The horn cycles at a half-second rate. To silence the horn, touch any control panel button.
- **System Event Indicators** – The status indicators on the UPS control panel work with the event horn to let the operator know when the UPS is operating in any mode other than double conversion. Only the normal mode indicator is illuminated during normal UPS system operation. The other indicators illuminate to indicate alarms or events. When an alarm occurs, first check these indicators to see what type of event has taken place. For descriptions of the status indicators, see paragraph [7.2.1 Status Indicators](#).
- **System Event Messages** – When a system event occurs, a message appears on the LCD in the UPS status area. This message is also written to the Events Log and may be added to the History Log. The messages are divided into four categories: alarms, notices, status, and commands.

7.2.3 Using the LCD Touch Screen

The LCD touch screen on the control panel provides an operator interface with the UPS system. [Figure 54](#) identifies the display areas discussed in the following sections.

All functions and commands are accessed by touching or tapping the screen tabs or buttons. When text input is required, either a Qwerty keyboard or numeric keypad will be displayed.

Figure 54. Parts of the LCD

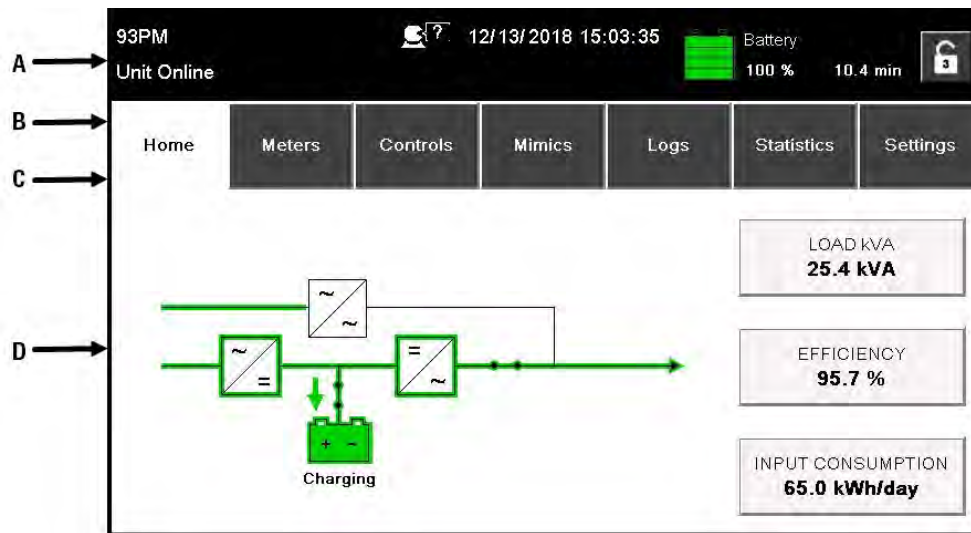

A - Status Bar displays the UPS name, UPS state, current date and time, meter information, active alarms and notices, and a sign in/sign out button. For more information about alarms and notices, see paragraph [7.2.2 System Events](#).

B - Main Menu Navigation Bar displays main menu functions and selections as tab buttons. To select a screen function touch the tab name.

C - Secondary Menu Navigation Bar displays functions and selections related to the current screen as tab buttons. To select a screen function touch the tab name.

D - Information Area contains status data, operational controls, acknowledgments, action confirmations, and screen prompts.

You can use the LCD touch screen to:

- Look at a log of UPS events (alarms, notices, and commands) (see paragraph [7.2.6 Display Menu Operation](#))
- Monitor UPS operation (see paragraph [7.2.6 Display Menu Operation](#))
- Set UPS parameters (see paragraph [7.2.6 Display Menu Operation](#))
- Control UPS operation (see paragraphs [7.2.6 Display Menu Operation](#) and [7.2.8 System Controls](#))

7.2.4 Using the Menu

The UPS navigation tab menu bar allows you to display data in the information area to help you monitor and control UPS operation. [Table 22](#) shows the basic menu structure.

Table 22. Display Function Menu Map

Menu Option	Description
HOME	Displays the system status both graphically (mimic) and written.
METERS	Displays performance meters for the system or critical load.
CONTROLS	Displays the Controls screen.
MIMIC	Displays the mimic screens and access to system information screens.
LOGS	Displays the list of active events and provides access to historical system events.
STATISTICS	Displays UPS statistical data (uptime, downtime, maintenance, efficiency, etc).
SETTINGS	Allows access to various screen controlled variables for the system operation. Settings include date and time for the time stamp, display language, the unit name, meter subscripts, password, and view the firmware version numbers Used only by service personnel.

**NOTE**

Screens shown are representative examples of system operation. The screen data will vary based on system activity at the time of observation.

7.2.5 Mimic Screen

[Figure 55](#) shows the Main Menu and Mimic screen.

The Mimic screen shows the internal components of the UPS cabinet and a real-time graphical representation of the operating status of the system.

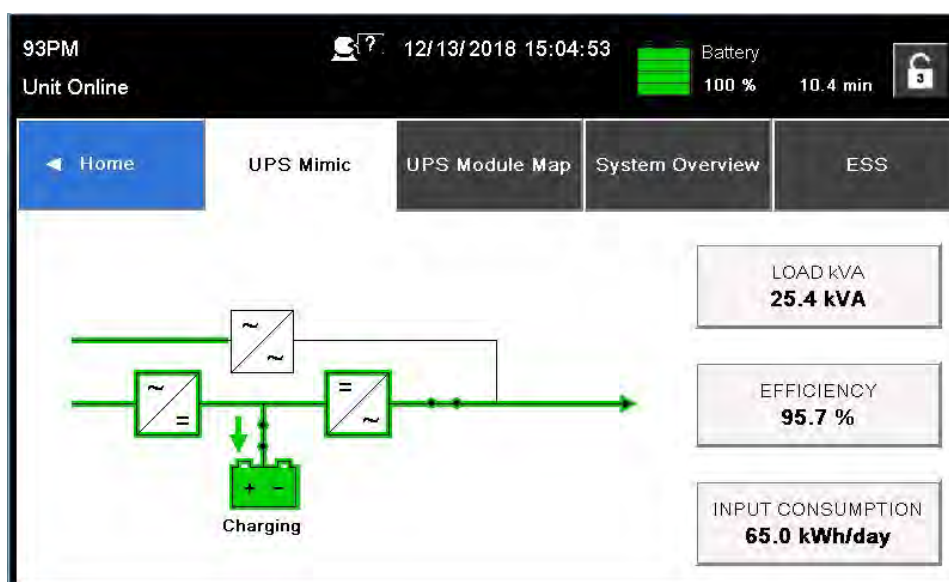
Figure 55. Main Menu and Mimic Screen

7.2.6 Display Menu Operation

[Table 23](#) describes the menu functions and how to use them.

Table 23. Display Menu Operation

Function	Subfunction	Operation
Home		An overview of UPS operation, including information on load, efficiency and consumption.
Meters – UPS		The meter screens show the UPS meter readings for the unit. The default voltage displayed on these screens is phase-to-neutral. These can be changed to display the voltage phase-to-phase (A-B, B-C, C-A). Tap the METERS tab on the main menu navigation bar to display the METER SUMMARY screen (see Figure 56). The current UPS readings are displayed in the information area of the screen. To display individual meter details, tap the desired meter button to display the detailed meter screen.
	Output – UPS	The Output screen shows output voltage (phase to neutral), output current (each phase), and frequency being supplied by the UPS, as well as the kVA, kW, and power factor measurements.
	Input – UPS	The Input screen shows input voltage (phase to neutral), input current (each phase), and frequency of the incoming utility source, as well as the kVA, kW, and power factor measurements.
	Bypass	The Bypass screen shows the bypass input voltage (phase to neutral), input current (each phase), and frequency of the incoming utility source, as well as the kVA, kW, and power factor measurements.
	Battery – UPS	The Battery screen displays the battery voltage (Vdc) and the battery current (Idc).
Mimics	UPS Mimic	Tap the MIMICS tab on the main menu navigation bar to display an overview of UPS operation, including information on load, efficiency and consumption. If there is an error, an error indicator is displayed next to the affected part. Active events log can be opened by tapping the error indicator.
	UPS Module Map	Tap the UPS MODULE MAP tab on the secondary menu navigation bar to display the status of each UPM.
	System Overview	Tap the SYSTEM OVERVIEW tab on the secondary menu navigation bar to display the status and meters summary for each UPS.
	ESS	Tap the ESS tab on the secondary menu navigation bar to display the approximate consumption and energy savings of ESS mode.
Logs	Active	Tap the LOGS tab on the main menu navigation bar to display the ACTIVE EVENTS screen (see Figure 57). A listing of all system events that are currently active is displayed. The most recent event is listed first. As events clear, they are removed from the Events listing. To scroll through the events, press the up or down scroll bar.
	System Log (Historical)	Tap the SYSTEM LOG tab on the secondary menu navigation bar to display the SYSTEM LOG screen (see Figure 58). The history Log lists up to 512 events in chronological order, with the most recent event listed last (once 512 is reached, the earliest event is overwritten). The end of the log (the most recent events) is displayed first; scroll upward to view older event listings. To scroll through the events, press the up or down scroll bar.
Settings		Configurable system settings. Tap the SETTINGS tab on the main menu navigation bar to display the settings screen. Settings may be password restricted. Settings Level 2 default password is 0101.

Table 23. Display Menu Operation (Continued)

Function	Subfunction	Operation
	User	Tap the USER tab on the secondary menu navigation bar to display the USER screen (see Figure 59). Tap the INFORMATION or ABOUT button to display system information (see Figure 60 and Figure 61).
	Configuration	Tap the CONFIGURATION tab on the secondary menu navigation bar to display the screen. Tap the function to be changed. Make and save the changes. Follow screen prompts to accept or abort changes. For additional functions, tap the 2 button. See Figure 62 and Figure 63 for configuration screens.
Statistics	Statistics Summary	Tap the STATISTICS tab on the main menu navigation bar to display a summary of UPS statistics (see Figure 64).
	Statistics Details	Tap the desired statistic button to display the detailed statistic screen.
Controls		See paragraph 7.2.8 System Controls for details.

Figure 56. Typical Meters Summary Screen

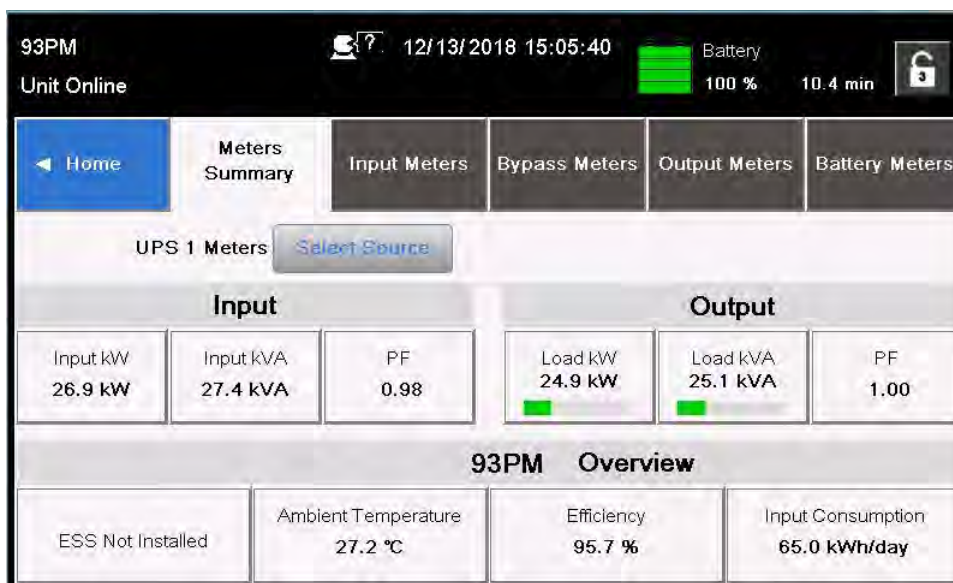

Figure 57. Typical Active Events Screen

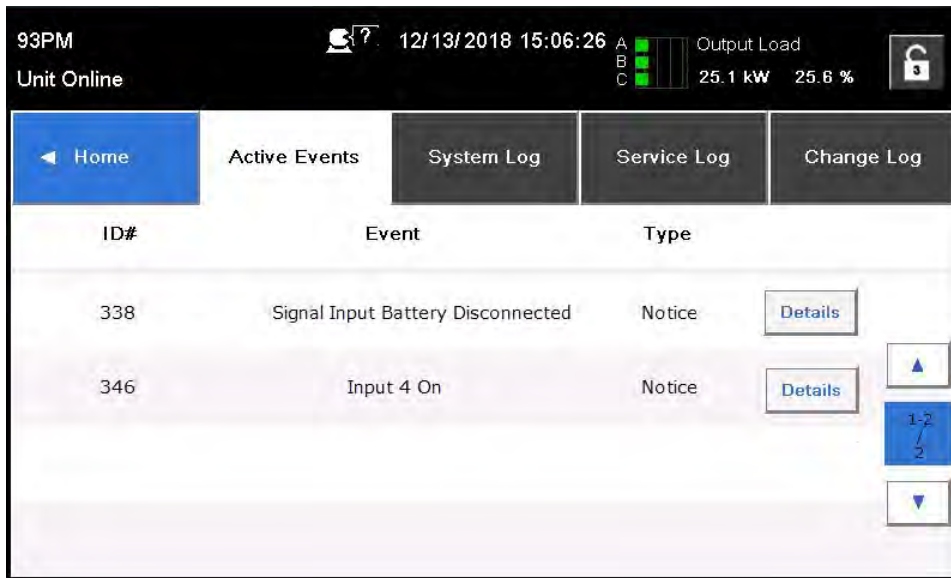

Figure 58. Typical System Log Screen

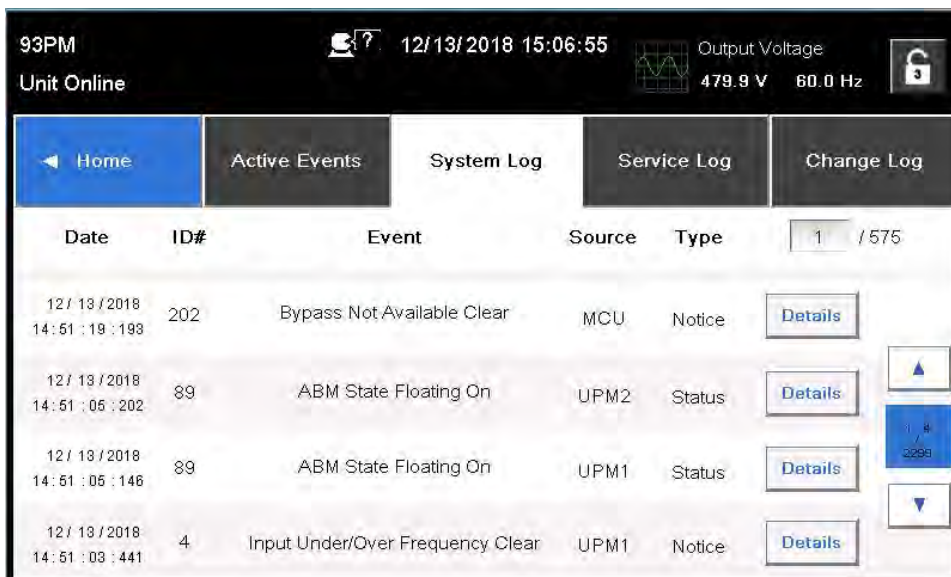

Figure 59. Typical Settings User Screen

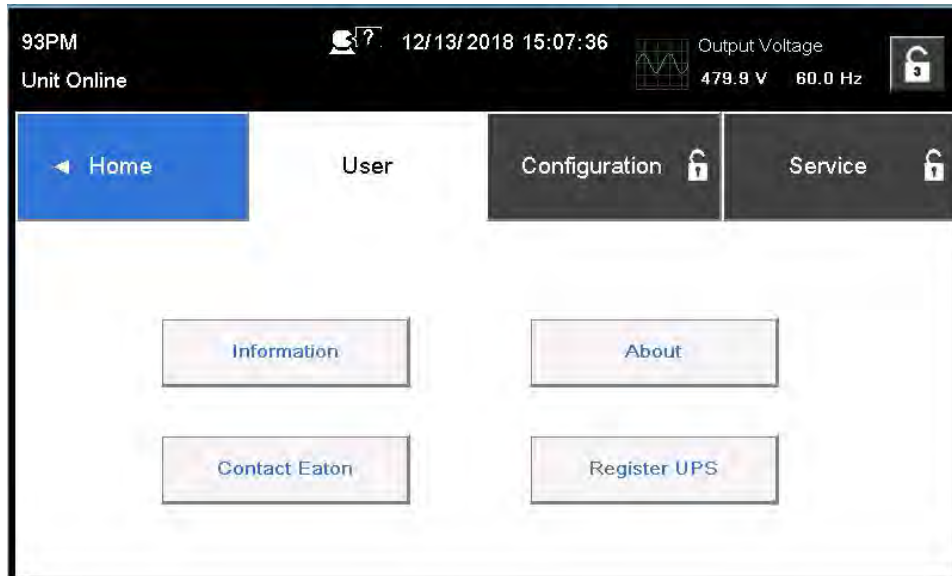

Figure 60. Typical Information Screen

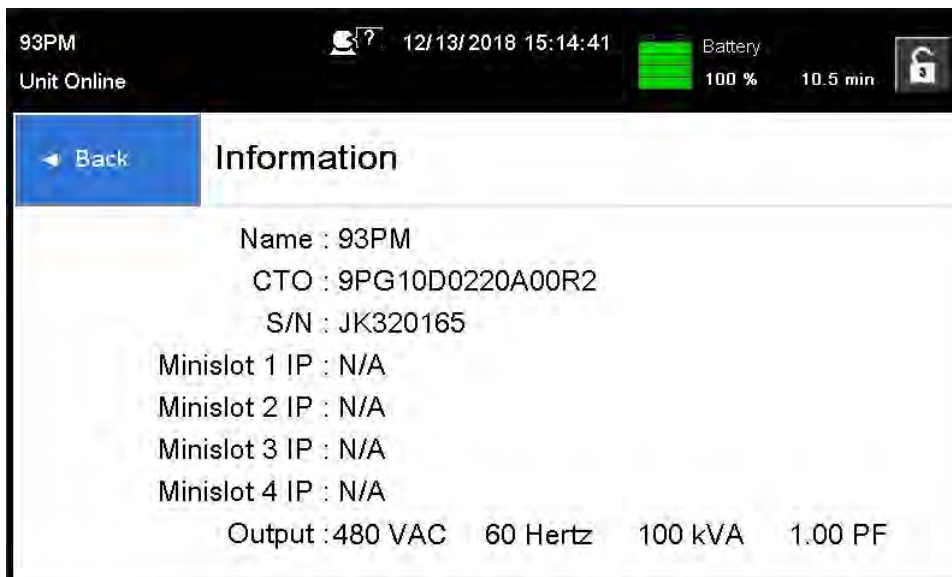

Figure 61. Typical About Screen



Figure 62. Typical Settings Configuration 1 Screen

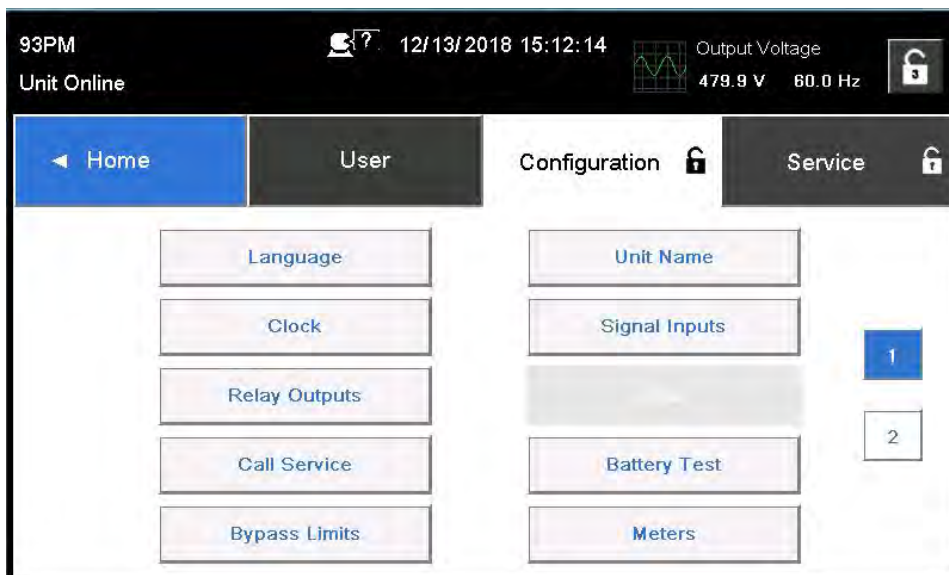

Figure 63. Typical Settings Configuration 2 Screen

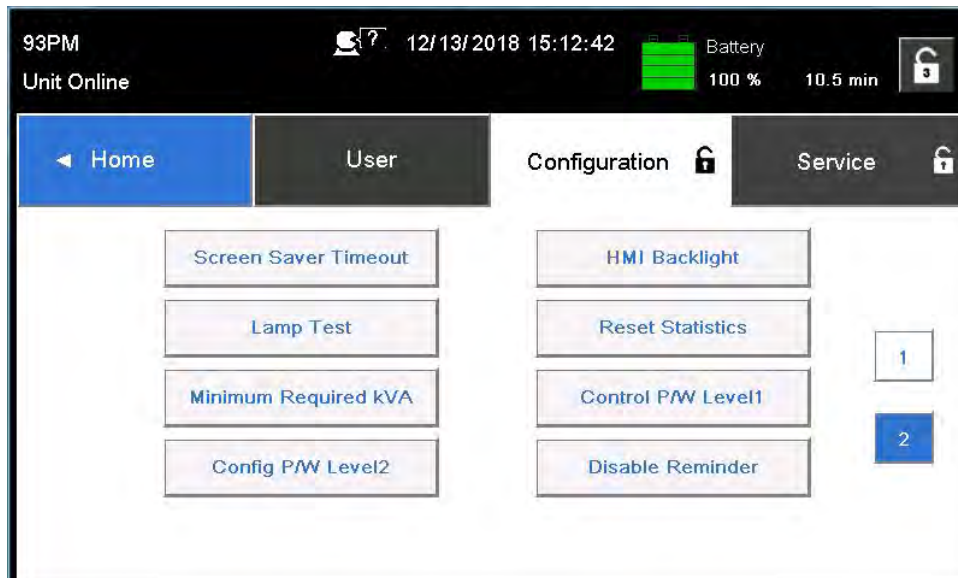
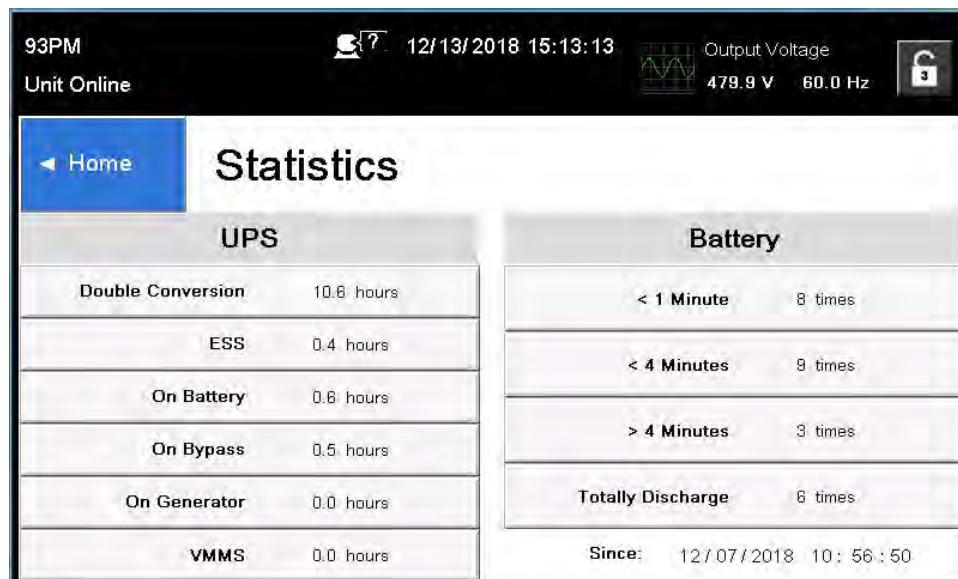

Figure 64. Typical Statistics Screen



7.2.7 Sign In

The Controls and Setting screens are restricted. The user must sign in using a password to gain access.



To prevent inadvertent or unauthorized power disruption to the critical load or auxiliary lighting system, change the Level 1 and Level 2 default passwords when system commissioning startup is performed.

To Sign in:

1. Tap the lock button in the upper right corner of the screen. The sign in screen is displayed (see [Figure 65](#)).
2. Tap the password entry area on the screen.
3. Enter the password using the keypad displayed and tap the return key (see [Figure 66](#)).
Level 1 default password is **1111**. Settings Level 2 default password is **0101**.
4. Sign in is complete. Tap continue to return to previous screen.

Figure 65. Sign In Password Screen

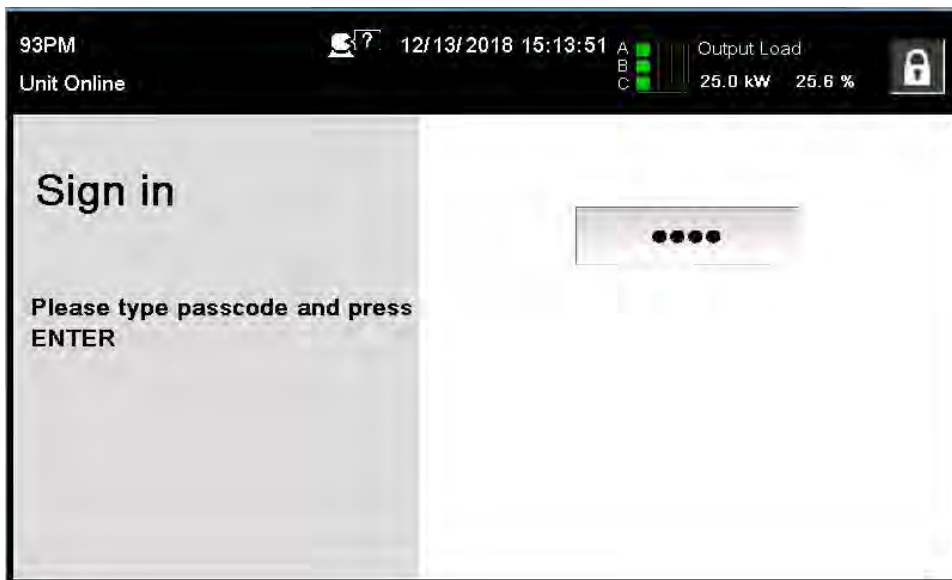

Figure 66. Sign In Keypad



7.2.8 System Controls

Tap the **CONTROLS** tab on the main menu navigation bar to display the Controls screen. Double conversion operation, transfer to bypass, shutdown, and charger control commands are controlled through this screen. In addition, the screen displays the current status of the UPS.

[Table 24](#) describes the control functions and provides instructions to access and use the command menu screens.

[Table 25](#) lists the typical System Status Screen Messages that are displayed during UPS operation.

For UPS operating instructions using the System Controls, see paragraph [7.3 Single UPS Operation](#) or [7.4 Multiple External Parallel System Operation](#).

[Figure 67](#) through [Figure 71](#) show the major control screens.

Table 24. Controls Menu Operation

Function	Subfunction	Operation
System Controls		The CONTROLS tab on the main menu navigation bar displays the System Controls screen.
	System Status	GO ONLINE starts the UPS in Double Conversion mode or transfers the UPS to Double Conversion mode from Bypass mode.
	Bypass	GO TO BYPASS starts the UPS in Bypass mode or transfers the UPS to Bypass mode from Double Conversion mode.
	Charger	TURN ON CHARGER/TURN OFF CHARGER sets the battery charger on or off.
	Battery Test	RUN BATTERY TEST starts the battery test.

Table 25. Typical System Status Messages

Function	Message
UPS	Double Conversion; Bypass; ESS
Bypass	Off; On; Available
Charger	Charger Resting; Charger

Figure 67. Typical System Control Screen

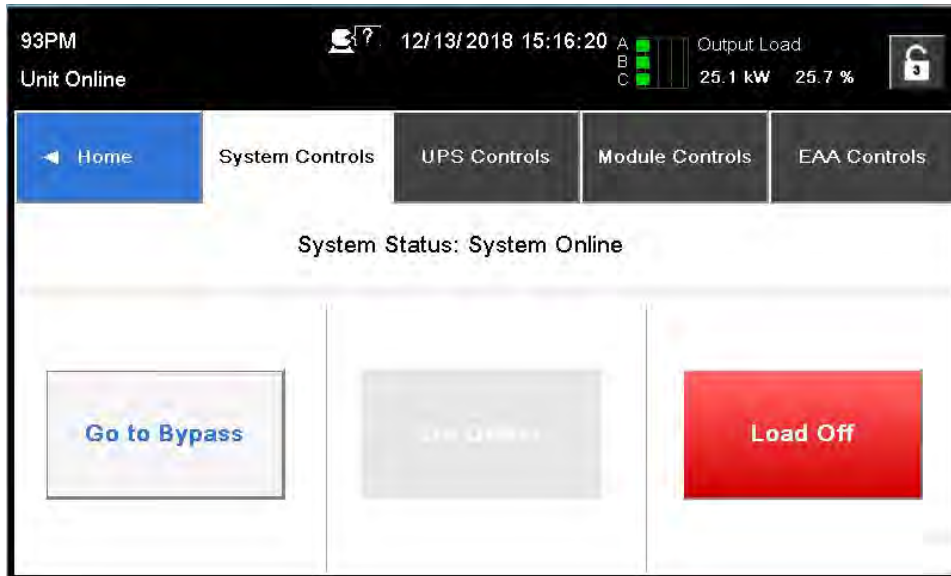

Figure 68. Typical UPS Control Screen

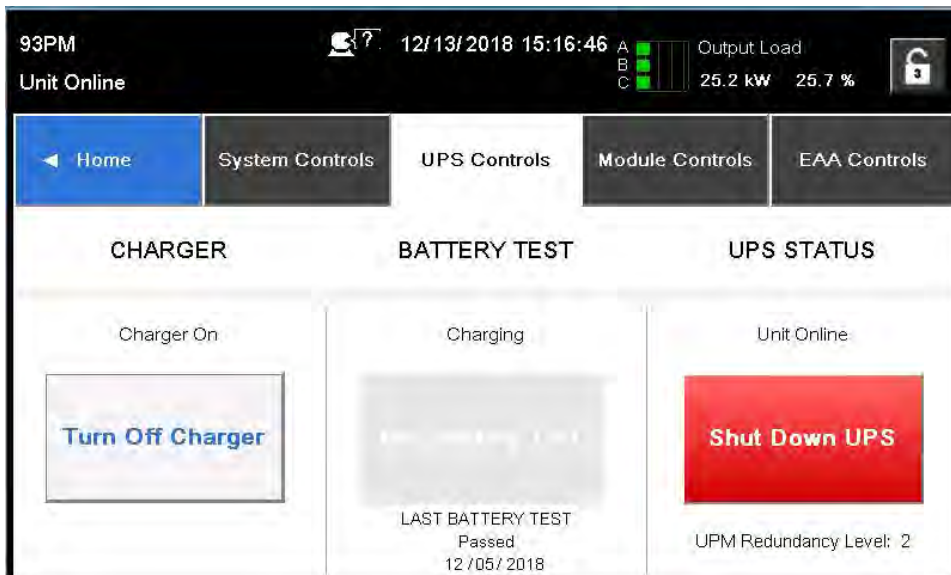

Figure 69. Typical UPM Select Screen

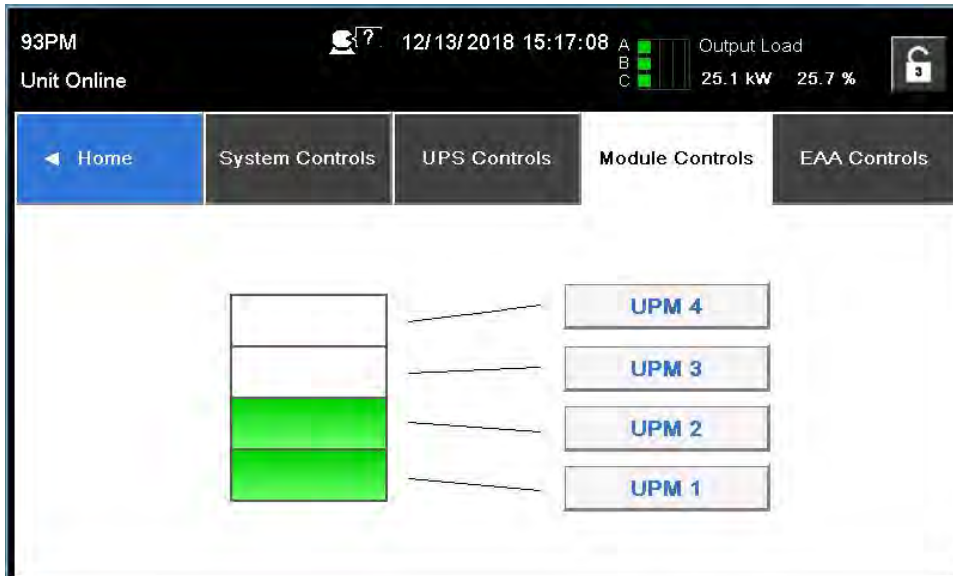

Figure 70. Typical UPM Control Screen

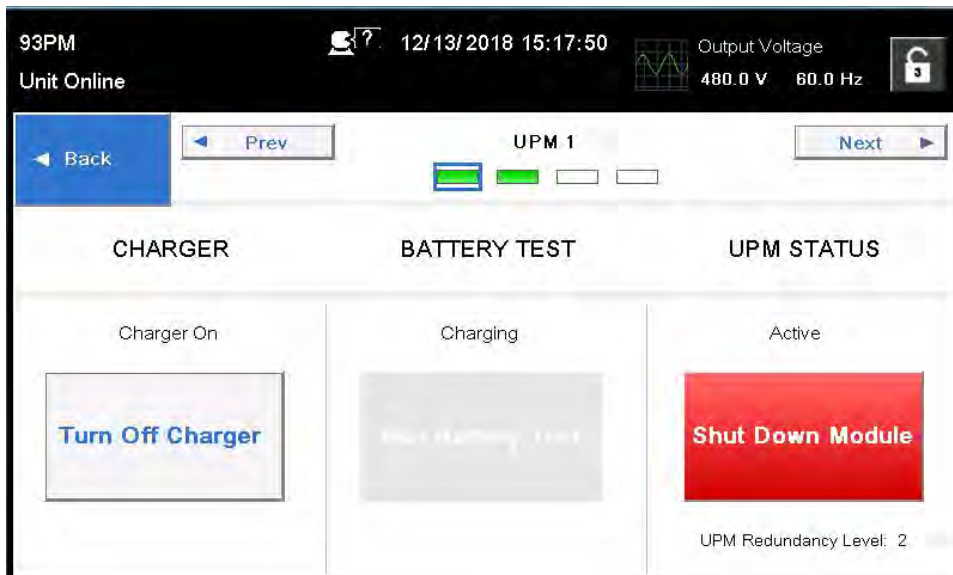
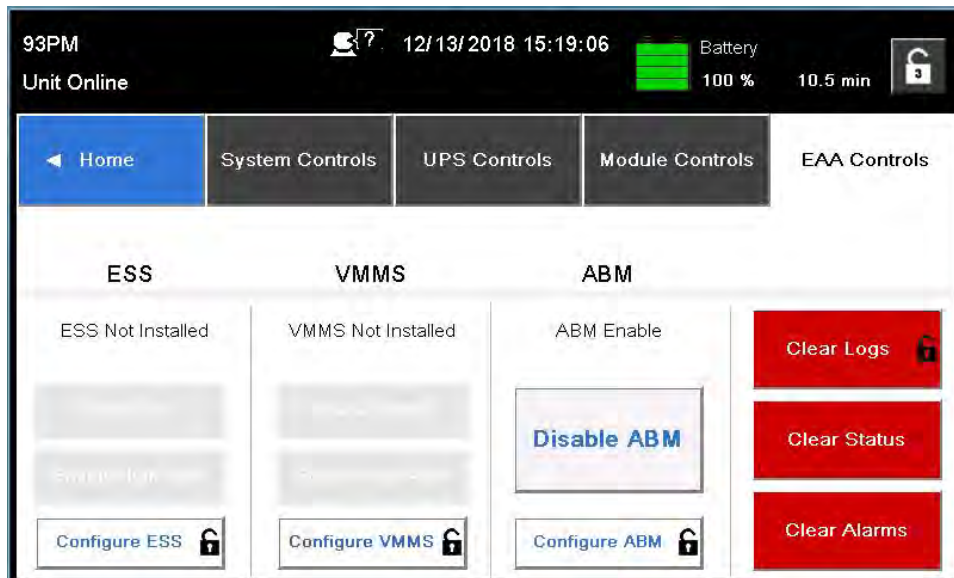

Figure 71. Typical EAA Control Screen



7.3 Single UPS Operation

NOTE 1 If an Integrated Battery Cabinet (IBC) is installed, refer to its installation and operation manual, listed in **Chapter 1 Introduction, For More Information** section, for IBC battery breaker location.

NOTE 2 If a Sidecar Integrated Accessory Cabinet (SIAC) or an Integrated Accessory Cabinet (IAC) is installed, refer to its installation and operation manual, listed in **Chapter 1 Introduction, For More Information** section, for operating instructions.

NOTE 3 This unit is a three-wire device. The loss of a single input phase will be considered a complete loss of input power and discharge the battery to provide power to the load.

7.3.1 Starting the UPS in Double Conversion Mode

To start the UPS system:

1. Close the UPS input feeder circuit breaker.
2. If dual feed, close the UPS bypass feeder circuit breaker.
3. If IBCs are installed, close the battery breakers.
4. Observe the UPS control panel display becoming active, indicating logic power.
5. Verify no alarms are active.
6. Tap the **CONTROLS** tab on the main menu navigation bar. The System Control screen is displayed.
7. Tap the **GO ONLINE** button.
8. If requested, enter the Level 1 password. Default password is 1111.

The rectifier and inverter turn on. The inverter continues to ramp up to full voltage.

Once the inverter reaches full voltage, the UPS inverter switchgear closes and the static switch turns off. Power is now supplied to the critical load in dual conversion mode. It takes approximately one minute for the UPS to achieve the dual conversion mode.

The Normal status indicator is illuminated.

7.3.2 Starting the UPS in Bypass Mode

If the inverter output of the UPS is not available and the critical load needs to be energized:



In Bypass mode, the critical load is not protected from commercial power interruptions and abnormalities.

1. Close the UPS input feeder circuit breaker.
2. If dual feed, close the UPS bypass feeder circuit breaker.
3. If IBCs are installed, close the battery breakers.
4. Observe the UPS control panel display becoming active, indicating logic power.
5. Verify no alarms are active.
6. Tap the **CONTROLS** tab on the main menu navigation bar. The System Control screen is displayed.
7. Tap the **GO TO BYPASS** button.

The critical load is immediately supplied by the bypass source, in Bypass mode.

The **BYPASS** status indicator is illuminated.

7.3.3 Starting the UPS via DC Start Button



Secure the UPS output. Performing DC start will energize UPS Output and customer loads (verify that no work is being done downstream).

If installed, verify that the Maintenance Bypass Breaker (MBP) is Open.

1. Open the UPS front door by lifting the latch from the bottom and turning to the right (counterclockwise) and swing the door open.
2. Verify that the UPS input breaker is open.
3. Close the UPS input feeder circuit breaker.
4. If dual feed, close the UPS bypass feeder circuit breaker.
5. Close the UPS input breaker.
6. If the UPS contains a Rectifier Input Breaker (RIB), close the Rectifier Input Breaker.
7. If the UPS contains a battery breaker, close the UPS battery breaker.
8. If Integrated Battery Cabinets (IBCs) are installed, close the IBC battery breakers.
9. Press the DC Start button on the front of each UPM to power on the UPM power supply. (See [Figure 72](#) for DC Start Button location).

Figure 72. DC Start Button Location

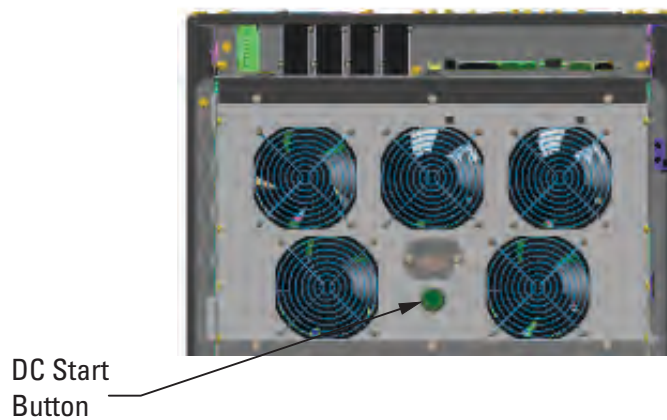

10. Close the door and secure the latch.
11. Observe the UPS control panel display becoming active, indicating logic power.
12. Verify no alarms are active.
13. Tap the **CONTROLS** tab on the main menu navigation bar. The System Control screen is displayed.
14. Tap the **GO ONLINE** button.

If requested, enter the Level 1 password. Default password is **1111**.

The unit will start on battery power. Restoration of utility power during this time will transfer the system to normal operation.

7.3.4 Starting the UPMs

To start the power modules without transferring the critical load to Double Conversion mode:

1. Close the UPS input feeder circuit breaker.
2. If dual feed, close the UPS Bypass input feeder circuit breaker.
3. Observe the UPS control panel becoming active, indicating logic power.
4. Verify no alarms are active.
5. Tap the **CONTROLS** tab on the main menu navigation bar. The System Control screen is displayed.
6. Tap the **MODULES CONTROLS** tab on the secondary Control menu navigation bar. The UPM Select screen is displayed.
7. On the UPM Select screen, select UPM 1. The UPM Control Screen is displayed.
8. Tap the **START MODULE** button.

The UPM 1 rectifier and inverter turn on. When the inverter reaches full voltage, the UPS is ready to transfer to the Double Conversion mode and supply the critical load.

9. Repeat Steps [Step 5](#) through [Step 8](#) selecting UPM 2 to start UPM 2.

The UPM 2 rectifier and inverter turn on. When the inverter reaches full voltage, the UPS is ready to transfer to the Double Conversion mode and supply the critical load.

10. Repeat Steps [Step 5](#) through [Step 8](#) selecting UPM 3 to start UPM 3.

The UPM 3 rectifier and inverter turn on. When the inverter reaches full voltage, the UPS is ready to transfer to the Double Conversion mode and supply the critical load.

7.3.5 Starting a Single UPM

To Start a single UPM:

1. Close the UPS input feeder circuit breaker.
2. If dual feed, close the UPS Bypass input feeder circuit breaker.
3. Observe the UPS control panel becoming active, indicating logic power.
4. Verify no alarms are active.
5. Tap the **CONTROLS** tab on the main menu navigation bar. The System Control screen is displayed.
6. Tap the **MODULES CONTROLS** tab on the secondary Control menu navigation bar. The UPM Select screen is displayed.
7. On the UPM Select screen, select the UPM to start. The UPM Control Screen is displayed.
8. Tap the **START MODULE** button.

The UPM rectifier and inverter turn on. When the inverter reaches full voltage, the UPS is ready to transfer to the Double Conversion mode and supply the critical load.

7.3.6 Transfer from Double Conversion to Bypass Mode

To transfer the critical load to Bypass mode:

⚠ CAUTION

In Bypass mode, the critical load is not protected from commercial power interruptions and abnormalities.

1. Tap the **CONTROLS** tab on the main menu navigation bar. The System Control screen is displayed.
2. Tap the **GO TO BYPASS** button.

The UPS transfers to Bypass mode, and the critical load is immediately supplied by the bypass source. If the bypass source is not available, the power module remains on and an alarm sounds.

The **BYPASS** status indicator is illuminated. The power module remains on.

⚠ WARNING

Power is present inside the UPS cabinet.

7.3.7 Transfer from Bypass to Double Conversion Mode

To transfer the critical load to Normal mode:

1. Tap the **CONTROLS** tab on the main menu navigation bar. The System Control screen is displayed.
2. Tap the **GO ONLINE** button.

The UPS transfers to Double Conversion mode. If the power module is not available, the system remains on bypass and an alarm sounds.

The **NORMAL** status indicator is illuminated.

7.3.8 Transfer from ESS Mode to Double Conversion Mode

To transfer the load to Standard Normal mode:

1. Tap the **CONTROLS** tab on the main menu navigation bar. The Control screen is displayed.
2. Tap the **EAA CONTROLS** tab on the secondary Control menu navigation bar. The **EAA CONTROLS** screen is displayed.
3. Tap the **DISABLE ESS** button.
The UPS transfers to Double Conversion mode.
The **NORMAL** status indicator is illuminated.

7.3.9 Transfer from Double Conversion Mode to ESS Mode

To transfer the load to HE Normal mode:

1. Tap the **CONTROLS** tab on the main menu navigation bar. The Control screen is displayed.
2. Tap the **EAA CONTROLS** tab on the secondary Control menu navigation bar. The **EAA CONTROLS** screen is displayed.
3. Tap the **ENABLE ESS** button.
The UPS transfers to ESS mode if no abnormal power conditions are detected. If abnormal power conditions are detected, the UPS will wait and transfer to ESS mode when conditions are cleared.
The **NORMAL** status indicator is illuminated.

7.3.10 Transfer from Double Conversion to Bypass Mode and Shut Down UPMs

To transfer the critical load to Bypass mode and shut down the UPMs:

1. Transfer the critical load to bypass by performing the procedure in paragraph [7.3.6 Transfer from Double Conversion to Bypass Mode](#).
2. Tap the **CONTROLS** tab on the main menu navigation bar. The System Control screen is displayed.
3. Tap the **MODULES CONTROLS** tab on the secondary Control menu navigation bar. The UPM Select screen is displayed.
4. On the UPM Select screen, select UPM 1. The UPM Control Screen is displayed.
5. Tap the **SHUT DOWN MODULE** button.
The UPM status indicates SHUTDOWN. The power module is turned off.
Logic power remains on.
6. Repeat Steps [Step 2](#) through [Step 5](#) selecting UPM 2 to shut down UPM 2.
The UPM status indicates SHUTDOWN. The power module is turned off.
Logic power remains on.
7. Repeat Steps [Step 2](#) through [Step 5](#) selecting UPM 3 to shut down UPM 3.
The UPM status indicates SHUTDOWN. The power module is turned off.
Logic power remains on.

7.3.11 Single UPM Shutdown

To shut down a single UPM:

1. Tap the **CONTROLS** tab on the main menu navigation bar. The System Control screen is displayed.
2. Tap the **MODULES CONTROLS** tab on the secondary Control menu navigation bar. The UPM Select screen is displayed.
3. On the UPM Select screen, select the UPM to shutdown. The UPM Control Screen is displayed.

4. Tap the **SHUT DOWN MODULE** button.

The UPM status indicates SHUTDOWN. The power module is turned off. The remaining UPMs continue to supply the critical load.

Logic power remains on.

7.3.12 Single UPM Restart

To restart a single UPM from a shutdown state:

1. Tap the **CONTROLS** tab on the main menu navigation bar. The System Control screen is displayed.
2. Tap the **MODULES CONTROLS** tab on the secondary Control menu navigation bar. The UPM Select screen is displayed.
3. On the UPM Select screen, select the UPM to start. The UPM Control Screen is displayed.
4. Tap the **START MODULE** button.

The UPM rectifier and inverter turn on. When the inverter reaches full voltage, the UPS is ready to transfer to the Double Conversion mode and supply the critical load.

7.3.13 UPS and Critical Load Shutdown

To perform maintenance or service on the critical load, shut down power to the load:

1. Turn off all equipment that is being powered by the UPS.
2. Perform the Load Off procedure in paragraph [7.3.16 Using the UPS LOAD OFF Command](#).
The inverter and bypass switchgear open, and the power module is turned off.
3. Perform the battery charger off procedure in paragraph [7.3.14 Charger Control](#).
The rectifier and battery switchgear open.

⚠ WARNING

Power is present inside the UPS cabinet until the upstream input feeder circuit breakers and battery breakers are opened. Wait at least 5 minutes before accessing internal components.

4. Open the UPS input feeder circuit breaker.
5. If dual feed, open the UPS bypass feeder circuit breaker.
6. If IBCs are installed, open all battery breakers.

7.3.14 Charger Control

To turn the battery charger on:

1. Tap the **CONTROLS** tab on the main menu navigation bar. The Control screen is displayed.
2. Tap the **UPS CONTROLS** tab on the secondary navigation bar. The UPS Control screen is displayed.
3. Tap the **TURN ON CHARGER** button.

To turn the battery charger off:

1. Tap the **CONTROLS** tab on the main menu navigation bar. The Control screen is displayed.
2. Tap the **UPS CONTROLS** tab on the secondary navigation bar. The UPS Control screen is displayed.
3. Tap the **TURN OFF CHARGER** button.

7.3.15 Battery Test

NOTE 1 The UPS has a user initiated battery test intended to determine if the batteries are able to support the load.



NOTE 2 The battery test is only able to be initiated when the battery is fully charged. This normally occurs within 72 hours of the start of a charging cycle. The command will not be shown if the test is not able to be run.

To start the battery test:

1. Tap the **CONTROLS** tab on the main menu navigation bar. The System Control screen is displayed.
2. Tap the **UPS CONTROLS** tab on the secondary navigation bar. The UPS Control screen is displayed.
3. Tap the **RUN BATTERY TEST** button.

7.3.16 Using the UPS LOAD OFF Command

A UPS shutdown is initiated by the **LOAD OFF** command on the UPS Control screen. The **UPS LOAD OFF** controls the UPS output by powering down the UPS and de-energizing the critical load.

The UPS (including Bypass) remains off until restarted.

To use the **LOAD OFF** command:

1. Tap the **CONTROLS** tab on the main menu navigation bar. The System Control screen is displayed.
-

CAUTION

All power to the critical load is lost when **LOAD OFF** is selected in the following step. You should use this feature only when you want to de-energize the critical load.

2. Tap the **LOAD OFF** button.

An action confirmation screen is displayed. Follow the on screen prompts to shut down the UPS or to cancel the shutdown. Selecting **YES** will immediately shut down the UPS and de-energize the critical load. Selecting **NO** will abort the shutdown.

CAUTION

Do not attempt to restart the system after Load Off until the cause of the shutdown has been identified and cleared.

3. To restart the UPS after using the **LOAD OFF** follow the procedure in paragraph [7.3.1 Starting the UPS in Double Conversion Mode](#) or [7.3.2 Starting the UPS in Bypass Mode](#).
-

WARNING

Power is present inside the UPS cabinet until the upstream input feeder circuit breakers and battery breakers are opened. Wait at least 5 minutes before accessing internal components.

7.3.17 Using the Remote Emergency Power-off Switch

⚠ WARNING

Emergency Power Off (EPO) and Remote Emergency Power Off (REPO) functionality is disabled for UPS systems configured for UL 924 auxiliary lighting. To remove power from the system a LOAD OFF command (see paragraph [7.3.16 Using the UPS LOAD OFF Command](#)) must be given using the front panel controls and all breakers opened.

A UPS emergency power-off is initiated by the REPO push-button switch. In an emergency, you can use this switch to control the UPS output. The REPO switch de-energizes the critical load and powers down the UPS immediately, without asking for verification.

The UPS, including Bypass, remains off until restarted.

⚠ CAUTION

All power to the critical load is lost when the REPO switch is activated in the following step. You should use this feature only when you want to de-energize the critical load.



NOTE

The following instructions are for the Eaton-supplied REPO switch. If a customer-supplied REPO switch is used, it may not activate in the same manner; refer to the operating instructions provided with the switch.

To use the REPO switch:

1. Firmly push the red push-button until it locks into place. The switch latches into the activated state (see [Figure 73](#)).

The rectifier, inverter, battery, and bypass switchgear open, and the power module is turned off immediately, without asking for verification.

⚠ CAUTION

Do not attempt to restart the system after the REPO until the cause of the shutdown has been identified and cleared.

2. To deactivate the REPO switch in preparation for restarting the UPS, insert the supplied key and rotate clockwise until the red push-button releases (see [Figure 73](#)). To remove the key, rotate the key back to the vertical position.
 3. Restart the UPS by following the procedure in paragraph [7.3.1 Starting the UPS in Double Conversion Mode](#) or [7.3.2 Starting the UPS in Bypass Mode](#).
-

⚠ WARNING

Power is present inside the UPS cabinet until the upstream input feeder circuit breakers and battery breakers are opened. Wait at least 5 minutes before accessing internal components.

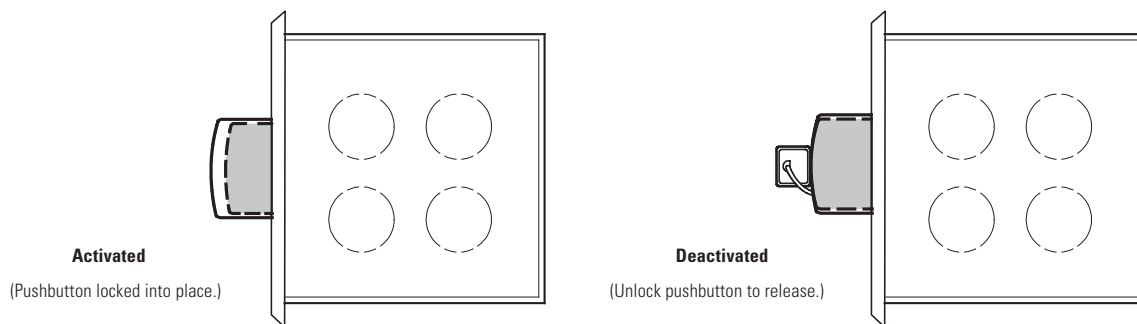
Figure 73. REPO Operation

7.4 Multiple External Parallel System Operation

NOTE 1 If an Integrated Battery Cabinet (IBC) is installed, refer to its installation and operation manual, listed in **Chapter 1 Introduction, For More Information** section, for IBC battery breaker location.



NOTE 2 If a Sidecar Integrated Accessory Cabinet (SIAC) or an Integrated Accessory Cabinet (IAC) is installed, refer to its installation and operation manual, listed in **Chapter 1 Introduction, For More Information** section, for operating instructions.

NOTE 3 This unit is a three-wire device. The loss of a single input phase will be considered a complete loss of input power and discharge the battery to provide power to the load.

7.4.1 Starting the Parallel System in Double Conversion Mode

To start the UPS system:

1. Close all Module Output Breakers (MOBs).
2. Close the UPS input feeder circuit breaker.
3. If dual feed, close the UPS bypass feeder circuit breaker.
4. If IBCs are installed, close the battery breakers.
5. Observe the UPS control panel display becoming active, indicating logic power.
6. Verify no alarms are active.
7. Tap the **CONTROLS** tab on the main menu navigation bar. The System Control screen is displayed.
8. Tap the **GO ONLINE** button.
9. If requested, enter the Level 1 password. Default password is 1111.

The rectifier and inverter turn on. The inverter continues to ramp up to full voltage.

Once the inverter reaches full voltage, all UPS inverter switchgear close and the static switches turn off. Power is now supplied to the critical load in dual conversion mode from all UPSs. It takes approximately one minute for the UPSs to achieve the dual conversion mode.

The Normal status indicator is illuminated.

7.4.2 Starting the Parallel System in Bypass Mode

If the inverter output of the UPS is not available and the critical load needs to be energized:

CAUTION

In Bypass mode, the critical load is not protected from commercial power interruptions and abnormalities.

1. Close all Module Output Breakers (MOBs).
2. Close the UPS input feeder circuit breaker.
3. If dual feed, close the UPS bypass feeder circuit breaker.
4. If IBCs are installed, close the battery breakers.
5. Observe the UPS control panel display becoming active, indicating logic power.
6. Verify no alarms are active.
7. Tap the **CONTROLS** tab on the main menu navigation bar. The System Control screen is displayed.
8. Tap the **GO TO BYPASS** button.

The critical load is immediately supplied by the bypass source, in Bypass mode from all UPSs.

The **BYPASS** status indicator is illuminated.

7.4.3 Starting the Parallel System UPMs

To start the power modules without transferring the critical load to Double Conversion mode:

1. Close the UPS input feeder circuit breaker.
2. If dual feed, close the UPS Bypass input feeder circuit breaker.
3. Observe the UPS control panel becoming active, indicating logic power.
4. Verify no alarms are active.
5. Tap the **CONTROLS** tab on the main menu navigation bar. The System Control screen is displayed.
6. Tap the **MODULES CONTROLS** tab on the secondary Control menu navigation bar. The UPM Select screen is displayed.
7. On the UPM Select screen, select UPM 1. The UPM Control Screen is displayed.
8. Tap the **START MODULE** button.

The UPM 1 rectifier and inverter turn on. When the inverter reaches full voltage, the UPS is ready to transfer to the Double Conversion mode and supply the critical load.

9. Repeat Steps [Step 5](#) through [Step 8](#) selecting UPM 2 to start UPM 2.

The UPM 2 rectifier and inverter turn on. When the inverter reaches full voltage, the UPS is ready to transfer to the Double Conversion mode and supply the critical load.

10. Repeat Steps [Step 5](#) through [Step 8](#) selecting UPM 3 to start UPM 3.

The UPM 3 rectifier and inverter turn on. When the inverter reaches full voltage, the UPS is ready to transfer to the Double Conversion mode and supply the critical load.

11. Repeat Steps [Step 1](#) through [Step 10](#) for each UPS in the parallel system.

7.4.4 Starting a Single UPM

To Start a single UPM:

1. Close the UPS input feeder circuit breaker.
2. If dual feed, close the UPS Bypass input feeder circuit breaker.

3. Observe the UPS control panel becoming active, indicating logic power.
4. Verify no alarms are active.
5. Tap the **CONTROLS** tab on the main menu navigation bar. The System Control screen is displayed.
6. Tap the **MODULES CONTROLS** tab on the secondary Control menu navigation bar. The UPM Select screen is displayed.
7. On the UPM Select screen, select the UPM to start. The UPM Control Screen is displayed.
8. Tap the **START MODULE** button.

The UPM rectifier and inverter turn on. When the inverter reaches full voltage, the UPS is ready to transfer to the Double Conversion mode and supply the critical load.

7.4.5 Transfer from Double Conversion to Bypass Mode

To transfer the critical load to Bypass mode:

⚠ CAUTION

In Bypass mode, the critical load is not protected from commercial power interruptions and abnormalities.

1. Tap the **CONTROLS** tab on the main menu navigation bar. The System Control screen is displayed.
2. Tap the **GO TO BYPASS** button.

All of the UPSs transfer to Bypass mode, and the critical load is immediately supplied by the bypass source. If the bypass source is not available, the power module remains on and an alarm sounds.

The **BYPASS** status indicator is illuminated. The power module remains on.

⚠ WARNING

Power is present inside the UPS cabinet.

7.4.6 Transfer from Bypass to Double Conversion Mode

To transfer the critical load to Normal mode:

1. Tap the **CONTROLS** tab on the main menu navigation bar. The System Control screen is displayed.
2. Tap the **GO ONLINE** button.

All of the UPSs transfer to Double Conversion mode. If the power module is not available, the system remains on bypass and an alarm sounds.

The **NORMAL** status indicator is illuminated.

7.4.7 Transfer from ESS Mode to Double Conversion Mode

To transfer the load to Standard Normal mode:

1. Tap the **CONTROLS** tab on the main menu navigation bar. The Control screen is displayed.
2. Tap the **EAA CONTROLS** tab on the secondary Control menu navigation bar. The **EAA CONTROLS** screen is displayed.
3. Tap the **DISABLE ESS** button.

All of the UPSs transfer to Double Conversion mode.

The **NORMAL** status indicator is illuminated.

7.4.8 Transfer from Double Conversion Mode to ESS Mode

To transfer the load to HE Normal mode:

1. Tap the **CONTROLS** tab on the main menu navigation bar. The Control screen is displayed.
2. Tap the **EAA CONTROLS** tab on the secondary Control menu navigation bar. The **EAA CONTROLS** screen is displayed..
3. Tap the **ENABLE ESS** button.

All of the UPSs transfer to ESS mode if no abnormal power conditions are detected. If abnormal power conditions are detected, the UPSs will wait and transfer to ESS mode when conditions are cleared.

The **NORMAL** status indicator is illuminated.

7.4.9 Transfer from Double Conversion to Bypass Mode and Shut Down all UPMs

To transfer the critical load to Bypass mode and shut down the UPMs:

1. Transfer the critical load to bypass by performing the procedure in paragraph [7.4.5 Transfer from Double Conversion to Bypass Mode](#).
2. Tap the **CONTROLS** tab on the main menu navigation bar. The System Control screen is displayed.
3. Tap the **MODULES CONTROLS** tab on the secondary Control menu navigation bar. The UPM Select screen is displayed.
4. On the UPM Select screen, select UPM 1. The UPM Control Screen is displayed.
5. Tap the **SHUT DOWN MODULE** button.
The UPM status indicates SHUTDOWN. The power module is turned off.
Logic power remains on.
6. Repeat Steps [Step 2](#) through [Step 5](#) selecting UPM 2 to shut down UPM 2.
The UPM status indicates SHUTDOWN. The power module is turned off.
Logic power remains on.
7. Repeat Steps [Step 2](#) through [Step 5](#) selecting UPM 3 to shut down UPM 3.
The UPM status indicates SHUTDOWN. The power module is turned off.
Logic power remains on.
8. Repeat Steps [Step 2](#) through [Step 7](#) for each UPS in the parallel system.

7.4.10 Single UPM Shutdown

To shut down a single UPM:

1. Tap the **CONTROLS** tab on the main menu navigation bar. The System Control screen is displayed.
2. Tap the **MODULES CONTROLS** tab on the secondary Control menu navigation bar. The UPM Select screen is displayed.
3. On the UPM Select screen, select the UPM to shutdown. The UPM Control Screen is displayed.
4. Tap the **SHUT DOWN MODULE** button.

The UPM status indicates SHUTDOWN. The power module is turned off. The remaining UPMs continue to supply the critical load.

Logic power remains on.

7.4.11 Single UPM Restart

To restart a single UPM from a shutdown state:

1. Tap the **CONTROLS** tab on the main menu navigation bar. The System Control screen is displayed.
2. Tap the **MODULES CONTROLS** tab on the secondary Control menu navigation bar. The UPM Select screen is displayed.
3. On the UPM Select screen, select the UPM to start. The UPM Control Screen is displayed.
4. Tap the **START MODULE** button.

The UPM rectifier and inverter turn on. When the inverter reaches full voltage, the UPS is ready to transfer to the Double Conversion mode and supply the critical load.

7.4.12 Single UPS Shutdown

To Shutdown a single UPS:



NOTE

To shut down a single UPS, MOB's with dual auxiliary contacts must be installed and connected according to the procedure in **Chapter 4 UPS System Installation, Installing Interface Connections** section.

To shut down a single UPS:

1. Open the MOB for the UPS being shut down.
UPS will load off. Logic power remains on.
2. Open the UPS input feeder circuit breaker.
3. If dual feed, open the UPS bypass feeder circuit breaker.
4. Open all battery breakers, internal and external IBCs if installed.

The UPS is now completely shut down.

7.4.13 Single UPS Restart

To restart a single UPS from a shutdown state:

1. Close the MOB for the UPS being restarted.
2. Close the UPS input feeder circuit breaker for the UPS being restarted.
3. If dual feed, close the UPS bypass feeder circuit breaker for the UPS being restarted.
4. If IBCs are installed, close the battery breakers for the UPS being restarted.
5. On the UPS being restarted, observe the UPS control panel display becoming active, indicating logic power.
6. Verify no alarms are active.
7. On the UPS being restarted, tap the **CONTROLS** tab on the main menu navigation bar. The System Control screen is displayed.
8. Tap the **GO ONLINE** button.
9. If requested, enter the Level 1 password. Default password is 1111.

The rectifier and inverter turn on. The inverter continues to ramp up to full voltage.

Once the inverter reaches full voltage, all UPS inverter switchgear close and the static switches turn off. Power is now supplied to the critical load in dual conversion mode from all UPSs. It takes approximately one minute for the UPSs to achieve the dual conversion mode.

The Normal status indicator is illuminated.



NOTE

If the UPS is starting on a bus with other online paralleled UPSs, the UPS will not go to bypass during startup. The UPS will start, sync to the other UPSs online, and go online.

7.4.14 Parallel System and Critical Load Shutdown

To perform maintenance or service on the critical load, shut down power to the load:

1. Turn off all equipment that is being powered by the UPS parallel system.
2. Transfer the UPSs to bypass by performing the procedure in paragraph [7.4.9 Transfer from Double Conversion to Bypass Mode and Shut Down all UPMs](#).
3. Perform the Load Off procedure in paragraph [7.4.17 Using the LOAD OFF Command](#).

The inverter and bypass switchgear open, and the power module is turned off on all UPSs.

4. Perform the battery charger off procedure in paragraph [7.4.15 Charger Control](#).

The rectifier and battery switchgear open.

⚠ WARNING

Power is present inside the UPS cabinet until the upstream input feeder circuit breakers and battery breakers are opened. Wait at least 5 minutes before accessing internal components.

5. Open the all of the UPSs input feeder circuit breaker.
6. If dual feed, open all of the UPSs bypass feeder circuit breaker.
7. If IBCs are installed, open all battery breakers.

7.4.15 Charger Control

To turn the battery charger on:

1. Tap the **CONTROLS** tab on the main menu navigation bar. The Control screen is displayed.
2. Tap the **UPS CONTROLS** tab on the secondary navigation bar. The UPS Control screen is displayed.
3. Tap the **TURN ON CHARGER** button.

To turn the battery charger off:

1. Tap the **CONTROLS** tab on the main menu navigation bar. The Control screen is displayed.
2. Tap the **UPS CONTROLS** tab on the secondary navigation bar. The UPS Control screen is displayed.
3. Tap the **TURN OFF CHARGER** button.

7.4.16 Battery Test

NOTE 1

This UPS has a user initiated battery test intended to determine if the batteries are able to support the load.



NOTE 2

The battery test is only able to be initiated when the battery is fully charged. This normally occurs within 72 hours of the start of a charging cycle. The command will not be shown if the test is not able to be run.

To start the battery test:

1. Tap the **CONTROLS** tab on the main menu navigation bar. The System Control screen is displayed.

2. Tap the **UPS CONTROLS** tab on the secondary navigation bar. The UPS Control screen is displayed.
3. Tap the **RUN BATTERY TEST** button.

7.4.17 Using the LOAD OFF Command

A UPS shutdown is initiated by the **LOAD OFF** command on the UPS Control screen. The UPS **LOAD OFF** controls the UPSs output by powering down all of the UPSs and de-energizing the critical load.

The UPSs (including Bypass) remains off until restarted.

To use the **LOAD OFF** command:

1. Tap the **CONTROLS** tab on the main menu navigation bar. The System Control screen is displayed.

⚠ CAUTION

All power to the critical load is lost when LOAD OFF is selected in the following step. You should use this feature only when you want to de-energize the critical load.

2. Tap the **LOAD OFF** button.

An action confirmation screen is displayed. Follow the on screen prompts to shut down the UPS or to cancel the shutdown. Selecting **YES** will immediately shut down the UPS and de-energize the critical load. Selecting **NO** will abort the shutdown.

⚠ CAUTION

Do not attempt to restart the system after Load Off until the cause of the shutdown has been identified and cleared.

3. To restart the UPS after using the **LOAD OFF** follow the procedure in paragraph [7.4.1 Starting the Parallel System in Double Conversion Mode](#) or [7.4.2 Starting the Parallel System in Bypass Mode](#).

⚠ WARNING

Power is present inside the UPS cabinet until the upstream input feeder circuit breakers and battery breakers are opened. Wait at least 5 minutes before accessing internal components.

7.4.18 Using the Remote Emergency Power-off Switch

⚠ WARNING

Emergency Power Off (EPO) and Remote Emergency Power Off (REPO) functionality is disabled for UPS systems configured for UL 924 auxiliary lighting. To remove power from the system a LOAD OFF command (see paragraph [7.4.17 Using the LOAD OFF Command](#)) must be given using the front panel controls and all breakers opened.

A UPS emergency power-off is initiated by the REPO push-button switch. In an emergency, you can use this switch to control the UPS output. The REPO switch de-energizes the critical load and powers down the UPSs immediately, without asking for verification.

The UPSs, including Bypass, remains off until restarted.

CAUTION

All power to the critical load is lost when the REPO switch is activated in the following step. You should use this feature only when you want to de-energize the critical load.

**NOTE**

The following instructions are for the Eaton-supplied REPO switch. If a customer-supplied REPO switch is used, it may not activate in the same manner; refer to the operating instructions provided with the switch.

To use the REPO switch:

1. Firmly push the red push-button until it locks into place. The switch latches into the activated state (see [Figure 73](#)).

The rectifier, inverter, battery, and bypass switchgear open, and the power module is turned off immediately on all UPSs, without asking for verification.

CAUTION

Do not attempt to restart the system after the REPO until the cause of the shutdown has been identified and cleared.

2. To deactivate the REPO switch in preparation for restarting the UPS, insert the supplied key and rotate clockwise until the red push-button releases (see [Figure 73](#)). To remove the key, rotate the key back to the vertical position.
3. Restart the UPS by following the procedure in paragraph [7.4.1 Starting the Parallel System in Double Conversion Mode](#) or [7.4.2 Starting the Parallel System in Bypass Mode](#).

WARNING

Power is present inside the UPS cabinet until the upstream input feeder circuit breakers and battery breakers are opened. Wait at least 5 minutes before accessing internal components.

Chapter 8 Communication

This chapter describes the communication features of the Eaton 93PM UPS.

8.1 Minislot Cards

The Eaton 93PM UPS has four standard, factory-installed Minislot communication bays. The UPS is compatible with the following Minislot cards (see [Figure 74](#)):

- The Power Xpert Gateway Minislot (PXGMS) UPS Card provides Web-enabled, real-time monitoring of Eaton 93PM uninterruptible power systems (UPSs) through standard Web pages, Power Xpert software, Intelligent Power Manager (IPM), Intelligent Power Protector (IPP), or third-party software. As an integral part of the Eaton Power Xpert Architecture®, the PXGMS UPS Card provides a central point to connect UPSs to the Ethernet network.

Network managers can view critical downstream device information, such as status, power, energy, and power quality data with an easy-to-use interface.

- Industrial Relay Card-Minislot (IRC-MS) – can be used to indicate the operating status of the UPS system using the customer's monitoring equipment. The Industrial Relay Card uses five isolated normally-open or normally-closed dry relay contacts to indicate the UPS status. Normal, Bypass, Battery, and Alarm modes can be monitored. See [Table 26](#) for default triggers. The contact ratings and wire range are listed in the IRC-MS installation guide. One input can be activated by a switch or dry contact. The voltage source is provided by the card, no external voltage source is needed.

For installation and setup of a Minislot card, contact an Eaton service representative. Refer to the manual supplied with the Minislot card for user instructions.

Figure 74. Optional Minislot Cards

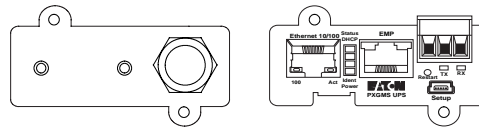

Table 26. IRC-MS Default Triggers

Relay	Trigger
K1	UPS supporting the load
K2	UPS on Battery
K3	Summary alarm
K4	UPS on bypass
K5	UPS battery low

8.2 Building Alarm Monitoring

This standard feature lets you connect the UPS to your building alarms, such as smoke detectors or overtemperature alarms. The building alarm customer interface terminals for external are located inside the UPS. Use twisted-pair wires for each alarm input and common.

The building alarms can be programmed to display the alarm functional name.

8.3 General Purpose Relay Contact

One general purpose relay contact is provided as a standard feature on the UPS. The relay contact customer interface terminals are located inside the UPS. Use twisted-pair wires for the normally-closed or normally-open and common connections.

Normally-closed or normally-open contacts can be used. If the state of the contact changes from the state specified as normal, a signal is issued. This contact can be connected to equipment at the facility (such as a light or an alarm bell) to notify the operator when an alarm is active on the UPS. This feature is useful if the UPS is located in a remote area where the UPS horn may not be heard immediately.



Contacts should not be operated in excess of 30 Vac or 28 Vdc @ 5A.



NOTE

If contact ratings are required that can be operated above the rated voltage and current available with the UPS general purpose relay contacts, an IRC-MS card should be used.

8.4 PredictPulse Remote Monitoring and Management Service

The Eaton 93PM UPS supports Eaton's PredictPulse remote monitoring and management service. PredictPulse is a subscription monitoring and management service that collects and analyzes data from connected power infrastructure devices, providing us with the insight needed to make recommendations and take action on your behalf. It's also powered by CA Technologies, bringing together the best in hardware and software. PredictPulse Service is included at no charge during the first year of Eaton 93PM UPS operation (warranty period) along with the required connectivity parts. Beyond that, it may be purchased with Eaton Support Agreements or as a standalone subscription after the initial warranty expires. PredictPulse may also be subscribed to for free as part of a 90-day trial period. PredictPulse availability and first year bundled offers may vary by market. For more information, visit www.eaton.com/predictpulse.

8.4.1 PredictPulse Service Features

PredictPulse provides proactive monitoring, an online dashboard, mobile app with alarm status information and a monthly report detailing the ongoing health of your Eaton 93PM UPS. Features include:

- Proactive monitoring that automatically analyzes the status of the Eaton 93PM UPS 96 times every day (every 15 minutes). All health data gathered from the unit, current and historical, is analyzed at the Customer Reliability Center (CRC). Algorithms and sophisticated analytics software is constantly scanning your UPS's data for potential failures. Anomalies are escalated to a Software and Monitoring analyst or Technical Support specialist. Critical events are remotely diagnosed to expedite repairs, including smart dispatch of field technicians with probable cause and likely parts (avoiding return visits due to lack of required parts). Through this service, the CRC can take pre-emptive, corrective action to ensure the highest level of availability of your Eaton 93PM UPS.
- Easy self-installation in minutes from a wizard installer or directly from the PXGMS card. PredictPulse uses standard Eaton connectivity hardware, requiring no special software (devices only need to be connected to a network).

- Ability to give an unlimited number of coworkers access to the real-time data and reports found in PredictPulse's online dashboard and mobile app. This allows you to collaborate and Eaton to notify the most appropriate person responsible for a specific site or device.
- Real-time access to key performance information, alarms and trended health data about your Eaton 93PM UPS via the PredictPulse online dashboard. Depending on the model, the dashboard aggregates all subscribed devices and provides detailed information about voltages, loads, energy savings, service levels, external factors such as temperature and humidity, attached batteries, and system availability. All of these factors contribute to the Relative Performance Index (RPI) score that allows you to compare your unit's health relative to Eaton's optimum UPS operating levels.
- Real-time alarm events for all subscribed devices via the PredictPulse mobile app (Apple and Android). You can track all alarms by device. As critical alarms occur, Eaton will acknowledge them so you know when Eaton has diagnosed the alarm (and pending notification of resolution).
- A monthly summary report that delivers key performance information, alarms and trended health data about your Eaton 93PM UPS, based on the prior month's data.
- A foundation based on CA Technologies' leading Data Center Infrastructure Management (DCIM) software application. This enables powerful reporting, analytics, security, and compatibility with hundreds of power infrastructure devices.

8.4.2 Installing PredictPulse

A quick start guide and self-installation wizard tool are available at www.eaton.com/predictpulse. The latest updates, installation tips and information on connecting PredictPulse are also available at that link. For installation support or questions about PredictPulse, contact predictpulsesupport@eaton.com.

PredictPulse relies on a PXGMS card installed with the UPS to send one-way outbound SMTP e-mails to Eaton, as well as an Environmental Monitoring Probe (EMP) for battery temperature/humidity monitoring. PredictPulse is secure as Eaton never communicates through your firewall—it only listens for health data and alarm data—and uses industry-standard security protocols. By using a common e-mail transport mechanism, you do not have to open your network to proprietary or potentially unsecure protocols and transports. The PXGMS Connectivity Card gathers information directly from the UPS and any external sensors that are attached, and transmits that data every 15 minutes (or 96 times per day), enabling real-time monitoring and advanced virtual preventive maintenance.

Chapter 9 UPS Maintenance

The components inside the UPS cabinet are secured to a sturdy metal frame. All repairable parts and assemblies are located for easy removal, with very little disassembly. This design allows authorized service personnel to perform routine maintenance and servicing quickly.

You must schedule periodic performance checks of your UPS system to keep it running properly. Regular routine checks of operation and system parameters enable your system to function efficiently for many trouble-free years.

9.1 Important Safety Instructions

Remember that your UPS system is designed to supply power **EVEN WHEN DISCONNECTED FROM THE UTILITY POWER**. The UPS module interiors are unsafe until the DC power source is disconnected and the electrolytic capacitors are discharged. After disconnecting the utility power and the DC power, authorized service personnel should wait at least five minutes for capacitor bleedoff before attempting internal access to the UPS module.

WARNING

- Servicing and maintenance should be performed by qualified service personnel only.
- **LETHAL VOLTAGE PRESENT.** This unit should not be operated with the cabinet doors open or protective panels removed. Do not make any assumptions about the electrical state of any cabinet in the UPS system.

Each battery string is an energy source in itself. **DO NOT ATTEMPT TO ACCESS ANY INTERNAL AREA OF THE BATTERY STRING YOURSELF. VOLTAGES ARE ALWAYS PRESENT IN THE BATTERY STRING.** If you suspect that a battery string needs service, contact an Eaton service representative.

If the string requires service contact an Eaton service representative.

Observe these precautions when working on or around batteries:

- Remove watches, rings, or other metal objects.
- Use tools with insulated handles.
- Wear rubber gloves and boots.
- Do not lay tools or metal parts on top of batteries.
- Disconnect the charging source prior to connecting or disconnecting terminals.
- Determine if the battery is inadvertently grounded. If it is, remove the source of the ground. Contact with any part of a grounded battery can result in electrical shock. The likelihood of such shock is reduced if such grounds are removed during installation and maintenance.
- When replacing batteries, use the same number of sealed, lead-acid batteries.
- Proper disposal of batteries is required. Refer to your local codes for disposal requirements.
- Do not dispose of batteries in a fire. Batteries may explode when exposed to flame.
- Do not open or mutilate batteries. Released electrolyte is harmful to the skin and eyes. It may be toxic.

9.2 Performing Preventive Maintenance

The UPS system requires very little preventive maintenance. However, the system should be inspected periodically to verify that the units are operating normally and that the batteries are in good condition.

9.2.1 DAILY Maintenance

Perform the following steps daily:

1. Check the area surrounding the UPS system. Ensure the area is not cluttered, allowing free access to the unit.
2. Ensure the air intakes (vents on the front door of the UPS cabinet and the exhaust openings (on the rear of the UPS cabinet) are not blocked.
3. Ensure the operating environment is within the parameters specified in paragraph **3.3.1 Environmental and Installation Considerations** and **Chapter 10 Product Specifications**.
4. Ensure the UPS is in Normal mode (Normal status indicator is illuminated). If an alarm lamp is illuminated or the Normal status indicator is not illuminated, contact an Eaton service representative.

9.2.2 MONTHLY Maintenance

Perform the following steps monthly:

1. Monitor system parameters as described in paragraph **7.2 Using the Control Panel**.
2. Check the UPS air filter (located behind the front door) and wash or replace as necessary. See [Figure 75](#) for filter location. Contact an Eaton service representative for replacement filters.



Verify washed filter is thoroughly dry before reinstalling.

To remove the filters:

- a. Unfasten the front door by lifting the latch from the bottom and turning to the right (counterclockwise) and swing the door open.
- b. Remove the foam filters from the frame on the front door.
- c. Install the spare foam filters, either washed or new foam filters, into the frame on the front door.



The foam filters are to be replaced with new or washed filter immediately. The UPS is not meant to be run without filters installed.

- d. Close the front door and secure the latch
3. Record maintenance results and any corrective actions in a suitable log.

Figure 75. Air Filter Location

9.2.3 PERIODIC Maintenance

Periodic inspections of the UPS should be made to determine if components, wiring, and connections exhibit evidence of overheating. Particular attention should be given to the compression lug connections. Maintenance procedures should specify that the compression lug connections be retorqued to values listed in this manual.

9.2.4 ANNUAL Maintenance

Annual preventive maintenance should be performed only by authorized service personnel familiar with maintenance and servicing of the UPS system. Contact an Eaton service representative for more information about service offerings.

9.2.5 BATTERY Maintenance

Contact an Eaton service representative for battery maintenance. Battery replacement and maintenance should be performed only by authorized service personnel.

9.3 Installing Batteries

**NOTE**

There is no manual DC disconnect device within the UPS.

Install batteries in accordance with the battery and battery system manufacturer's instructions.

9.4 Recycling the Used Battery or UPS

Contact your local recycling or hazardous waste center for information on proper disposal of the used battery or UPS.

⚠ WARNING

- Do not dispose of the battery or batteries in a fire. Batteries may explode. Proper disposal of batteries is required. Refer to your local codes for disposal requirements.
- Do not open or mutilate the battery or batteries. Released electrolyte is harmful to the skin and eyes. It may be toxic.
- A battery can cause electrical shock, burn from high short-circuit current, or fire. Observe proper precautions.

⚠ CAUTION

- Une batterie peut présenter un risque de choc électrique, de brûlure, ou d'incendie. Suivre les précautions qui s'imposent.
- Pour le remplacement, utiliser le même nombre et modèle des batteries.
- L'élimination des batteries est réglementée. Consulter les codes locaux à cet effet.

 **CAUTION**

Do not discard the UPS or the UPS batteries in the trash. This product contains sealed, lead-acid batteries and must be disposed of properly. For more information, contact your local recycling/reuse or hazardous waste center.

 **CAUTION**

Do not discard waste electrical or electronic equipment (WEEE) in the trash. For proper disposal, contact your local recycling/reuse or hazardous waste center.

9.5 Maintenance Training

A basic training course, available from Eaton, gives you a competent working knowledge of the UPS system operation and teaches you how to perform first level corrective maintenance. For more information about training and other services, contact the Customer Reliability Center (see paragraph **1.9 Getting Help**).

Chapter 10 Product Specifications

10.1 Model Numbers

The UPS is housed in a free-standing cabinet with safety shields behind the door. The UPS is available in 50 or 60 Hz with various output power ratings.

Model	Power Rating	Frequency
Eaton 93PM-150-1 Eaton 93PM-150-2 (N+1)	20 kW	50/60 Hz
Eaton 93PM-150-1 Eaton 93PM-150-2 (N+1)	30 kW	50/60 Hz
Eaton 93PM-150-1 Eaton 93PM-150-2 (N+1)	40 kW	50/60 Hz
Eaton 93PM-150-1 Eaton 93PM-150-2 (N+1)	50 kW	50/60 Hz
Eaton 93PM-150-2 Eaton 93PM-150-3 (N+1)	60 kW	50/60 Hz
Eaton 93PM-150-2 Eaton 93PM-150-3 (N+1)	70 kW	50/60 Hz
Eaton 93PM-150-2 Eaton 93PM-150-3 (N+1)	80 kW	50/60 Hz
Eaton 93PM-150-2 Eaton 93PM-150-3 (N+1)	90 kW	50/60 Hz
Eaton 93PM-150-2 Eaton 93PM-150-3 (N+1)	100 kW	50/60 Hz
Eaton 93PM-150-3	110 kW	50/60 Hz
Eaton 93PM-150-3	120 kW	50/60 Hz
Eaton 93PM-150-3	130 kW	50/60 Hz
Eaton 93PM-150-3	140 kW	50/60 Hz
Eaton 93PM-150-3	150 kW	50/60 Hz

10.2 Specifications

The following sections detail the input, output, environmental, and battery specifications for the UPS.

10.2.1 UPS Input

Operating Input Voltage	480 Vac Wye, 3W + ground. Neutral not used.
Operating Input Frequency Range	50/60 Hz
Operating Input Current	See Table 5 , Table 6 , or Table 7 . Reduced for Generator Adjustable
Input Current Harmonic Content	3% THD at full load
Power Factor	Minimum 0.99
Line Surges	6 kV OC, 3 kA SC per ANSI 62.41 and IEC 801 4
Battery Voltage	216 cell – 432 Vdc 240 cell – 480 Vdc
Battery Charging Capacity	16.5 A maximum per 50 kW module at full load at nominal input voltage

10.2.2 UPS Output

UPS Output Capacity	100% rated current
Output Voltage Regulation	± 1% (10% to 100% load)
Output Voltage	480 Vac Wye, 3W + ground. No Neutral.
Output Voltage Harmonic Content	1% maximum THD (linear load) 5% maximum THD (nonlinear load)
Output Current	See Table 5 , Table 6 , or Table 7 .
Output Voltage Balance	< 2% for 100% maximum load imbalance (linear load)
Output Voltage Phase Displacement	< 2.5° for 100% maximum load imbalance (linear load)
Frequency Regulation	0.1 Hz free running
Synchronous to Bypass	± 4 Hz (default setting)
Frequency Slew Rate	1 Hz per second (default setting)
Load Compatibility	0.8 pF Leading 0.8 pF Lagging
Overload Capability	<110% for 10 minutes <125% for 60 seconds <150% for 10 seconds >150% for 300 milliseconds

10.2.3 UPS Environmental

Operating Temperature	5 to 40°C (41 to 104°F) without derating. The recommended operating temperature is 25°C (77°F).
Operating Altitude	Maximum 1500m (5000 ft) at 40°C without derating
Storage Temperature	-25 to +55°C, excluding batteries (prolonged storage above 40°C causes rapid battery self-discharge)
Relative Humidity (operating and storage)	5 to 95%, noncondensing
Acoustical Noise	150 kW at 100% load – 65 dBA at a 1m distance, per ISO 7779
Agency Markings	UL 924 Auxiliary Lighting and Power Equipment Safety: UL1778 5th Ed./CSA22.2 No. 107.3-14 3rd Ed.
EMI Emissions and Immunity	Meets IEC 62040-2 C3 and FCC Part 15 Subpart B Class A, ICES-003, CISPR 22
Electrostatic Discharge (ESD) Immunity	Meets IEC 61000-4-2 Level 3 specifications. Withstands up to 4 kV contact pulse without damage and with no disturbance or adverse effect to the critical load.

Chapter 11 Warranty

To view the UPS warranty please click on the link or copy the address to download from the Eaton website:
[UPS Product Warranty](#)

<https://www.eaton.com/content/dam/eaton/products/backup-power-ups-surge-it-power-distribution/backup-power-ups/portfolio/eaton-three-phase-ups-warranty.pdf>

EQUIPMENT REGISTRATION

Please visit www.eaton.com/pg/register to register your new Eaton UPS / Eaton UPS Accessory.

Model Number:

Serial Number:



164000388 08