

Eaton® 9155 Parallel UPS

8–15 kVA
User's Guide



p/n: 164201592
Revision E0

Class A EMC Statements

FCC Part 15

NOTE  This equipment has been tested and found to comply with the limits for a Class A digital device, pursuant to part 15 of the FCC Rules. These limits are designed to provide reasonable protection against harmful interference when the equipment is operated in a commercial environment. This equipment generates, uses, and can radiate radio frequency energy and, if not installed and used in accordance with the instruction manual, may cause harmful interference to radio communications. Operation of this equipment in a residential area is likely to cause harmful interference in which case the user will be required to correct the interference at his own expense.

ICES-003

This Class A Interference Causing Equipment meets all requirements of the Canadian Interference Causing Equipment Regulations ICES 003.

Cet appareil numérique de la classe A respect et outes les exigences du Reglement sur le matériel brouilleur du Canada.

IEC 62040-2

Some configurations are classified under IEC 62040-2 as "C2 UPS for Unrestricted Sales Distribution."

VCCI Notice

この装置は、情報処理装置等電波障害自主規制協議会（VCCI）の基準に基づくクラスA情報技術装置です。この装置を家庭環境で使用すると電波妨害を引き起こすことがあります。この場合には使用者が適切な対策を講ずるよう要求されることがあります。

Eaton reserves the right to change specifications without prior notice. Modbus is a registered trademark of Schneider Automation, Inc. MOXA is a registered trademark and MGate is a trademark of MOXA, Inc. Spiralock is a registered trademark of Spiralock Corporation. KIRK is a registered trademark of Kirk Key Interlock company, LLC, a subsidiary of Halma plc. National Electrical Code and NEC are registered trademarks of National Fire Protection Association, Inc. ERIFLEX and FLEXIBAR are registered trademark of Erico International Corporation. All other trademarks are property of their respective companies.

©Copyright 2004-2019 Eaton, Raleigh, NC, USA. All rights reserved. No part of this document may be reproduced in any way without the express written approval of Eaton.

Special Symbols

The following are examples of symbols used on the product to alert you to important information:



RISK OF ELECTRIC SHOCK - Observe the warning associated with the risk of electric shock symbol.



CAUTION: REFER TO OPERATOR'S MANUAL - Refer to your operator's manual for additional information, such as important operating and maintenance instructions.



This symbol indicates that you should not discard the product in the trash. This product must be disposed of properly. For more information, contact your local recycling/reuse or hazardous waste center.



This symbol indicates that you should not discard waste electrical or electronic equipment (WEEE) in the trash. For proper disposal, contact your local recycling/reuse or hazardous waste center.



ON - Indicates that the switch is in the ON position.



OFF - Indicates that the switch is in the OFF position.



PHASE - The word "phase."



IMPORTANT

To ensure you have the most up-to-date content and information for this product, please review the latest manual revision on our website, www.eaton.com/9155.

Table of Contents

1 Introduction	1
1.1 Options and Accessories	2
1.1.1 Parallel Tie Cabinet	2
1.1.2 Maintenance Bypass Module (MBM)	2
1.1.3 Power Distribution Module (PDM)	2
1.1.4 Bypass Power Module	2
1.1.5 Input Isolation Transformer	2
1.1.6 Seismic Kit	2
1.2 Using This Manual	3
1.3 Conventions Used in This Manual	3
1.4 For More Information	3
1.5 Getting Help	4
1.6 Equipment Registration	4
2 Safety Warnings	5
2.1 Consignes de Sécurité	6
2.1.1 CONSIGNES DE SÉCURITÉ IMPORTANTES CONSERVER CES INSTRUCTIONS	6
2.2 Advertencias de Seguridad	7
2.2.1 INSTRUCCIONES DE SEGURIDAD IMPORTANTES GUARDE ESTAS INSTRUCCIONES	7
3 UPS Installation Plan and Unpacking	9
3.1 Creating an Installation Plan	9
3.2 Preparing the Site	9
3.2.1 Environmental and Installation Considerations	9
3.3 UPS System Power Wiring Preparation	11
3.4 Inspecting and Unpacking the Equipment	13
4 Parallel UPS System Installation	15
4.1 Preliminary Installation Information	15
4.2 Unloading the UPS Cabinet from the Pallet	15
4.3 Parallel Installation	18
4.4 Installing Options	28
4.4.1 Powerware Hot Sync CAN Bridge Card	29
4.5 Stabilizing the Cabinet	35
4.6 Extended Battery Module Installation	39
5 UPS Operating Instructions	43
5.1 Control Panel Functions	43
5.1.1 Changing the Language	44
5.1.2 Display Functions	44
5.1.3 User Settings	45
5.2 Parallel UPS Startup	47

Table of Contents

5.3 Configuring the UPS for EBMs	48
5.4 Parallel System Shutdown	49
5.5 Individual UPS Shutdown	49
5.6 Restarting the Parallel System	50
5.7 Parallel UPS Bypass Operation	50
6 Troubleshooting	53
6.1 Typical Alarms and Conditions	53
6.2 Silencing the Alarm	54
6.3 Service and Support	54
7 Warranty	57

List of Figures

Figure 1.	The Eaton 9155 UPS and EBM (2-High Cabinets Shown)	1
Figure 2.	Removing the Stabilizing Bracket Bolts	16
Figure 3.	Removing the Brackets and Shipping Pad.....	17
Figure 4.	Unloading the Cabinet.....	18
Figure 5.	Removing the Pallet.....	18
Figure 6.	Parallel Tie Cabinet Front Cover.....	20
Figure 7.	Internal Cover.....	21
Figure 8.	Parallel Bypass Breaker	22
Figure 9.	UPS Rear View (2-High Shown)	23
Figure 10.	UPS Terminal Block	24
Figure 11.	UPS to Parallel Tie Cabinet Wiring.....	25
Figure 12.	Load Connections	26
Figure 13.	Parallel AC Input Wiring	27
Figure 14.	Parallel Wiring Diagram	28
Figure 15.	Communication Options and Control Terminals	29
Figure 16.	Powerware Hot Sync CAN Bridge Card.....	30
Figure 17.	Removing the Front Covers.....	30
Figure 18.	Setting the CAN Bridge Card Jumper J7 (Side View)	31
Figure 19.	CAN Bridge Card Wiring	33
Figure 20.	Removing Knockout Tabs	34
Figure 21.	Reinstalling the Front Covers.....	35
Figure 22.	Lowering the Leveling Feet	36
Figure 23.	Stabilizing Bracket with One Cabinet	37
Figure 24.	Stabilizing Bracket with Two Cabinets	38
Figure 25.	Stabilizing Bracket with Three Cabinets.....	39
Figure 26.	Typical EBM Installation (2-High Cabinets Shown)	40
Figure 27.	Front Ground Strap Installation (2-High Cabinets Shown)	41
Figure 28.	Eaton UPS Control Panel.....	43

List of Figures

List of Tables

Table 1.	Air Conditioning or Ventilation Requirements During Full Load Operation.....	10
Table 2.	UPS Cabinet Weights	11
Table 3.	UPS Cabinet Clearances	11
Table 4.	UPS Terminal Block (TB1) Wiring	12
Table 5.	Input Isolation Transformer Terminal Block Wiring	12
Table 6.	MBM/PDM Terminal Block (TB10) Wiring	13
Table 7.	Circuit Breaker Ratings	19
Table 8.	Recommended Terminal Block Wiring	23
Table 9.	Menu Map for Display Functions	44
Table 10.	User Settings.....	45

List of Tables

Chapter 1 Introduction

A parallel system with up to three uninterruptible power supplies (UPSs) can be installed to provide a parallel capacity and/or redundant system. This load sharing system provides more capacity than a single UPS and can provide backup, depending on the load and configuration. In addition, when one UPS is taken out of service for maintenance or is not operating properly, a redundant UPS continues to supply uninterrupted power to the critical load. A parallel Eaton® Powerware Hot Sync® Controller Area Network (CAN) Bridge Card provides connectivity for system metering and operational mode control. The parallel system consists of two or three UPSs, each with a CAN Bridge Card and a parallel tie cabinet.

[Figure 1](#) shows the Eaton 9155 UPS and an optional Extended Battery Module (EBM).

Figure 1. The Eaton 9155 UPS and EBM (2-High Cabinets Shown)

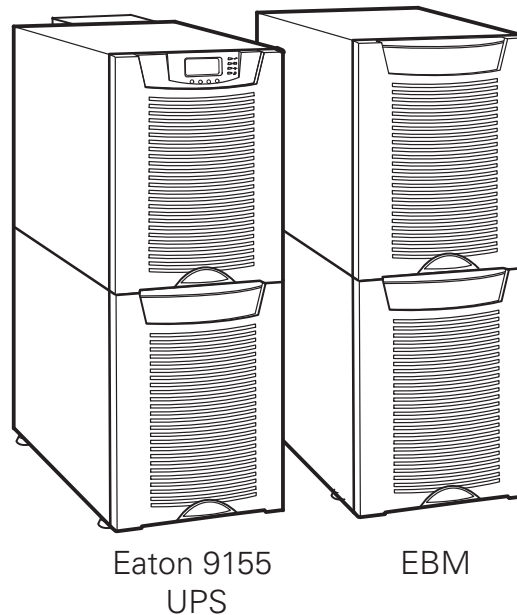

Providing outstanding performance and reliability, the Eaton 9155's unique benefits including the following:

- Online UPS design with pure sine wave output. The UPS filters and regulates incoming AC power and provides consistent power to your equipment without draining the battery.
- More wattage in less space with a 0.9 power factor—protecting more equipment and leaving more room for expansion.
- Support for Powerware Hot Sync® paralleling of multiple modules for redundancy or extra capacity.
- Input current total harmonic distortion (THD) of less than five percent, using active input power factor correction.
- ABM® technology that uses advanced battery management to increase battery service life, optimize recharge time, and provide a warning before the end of useful battery life.
- Start-on-battery capability for powering up the UPS even if utility power is not available.
- Up to four hours of extended runtime with added EBMs.

- Emergency shutdown control through the remote emergency power-off (REPO) port.
- Standard communication options with a DB-9 serial port, relay output contacts, and programmable signal inputs.
- Optional X-Slot® cards with enhanced communication capabilities for increased power protection and control.
- Advanced power management with the Software Suite CD for graceful shutdowns and power monitoring.
- Backed by worldwide agency approvals.

1.1 Options and Accessories

The following options for the Eaton 9155 are available:

1.1.1 Parallel Tie Cabinet

The parallel tie cabinet is used to connect up to three UPSs providing parallel capacity and/or redundant system. This load sharing system provides more capacity than a single UPS and can provide backup, depending on the load and configuration. In addition, when one UPS is taken out of service for maintenance or is not operating properly, a redundant UPS continues to supply uninterrupted power to the critical load. A parallel Powerware Hot Sync Controller Area Network (CAN) Bridge Card provides connectivity for system metering and operational mode control. The parallel system consists of two to three UPSs, each with a parallel CAN Bridge Card, and a parallel tie cabinet.

1.1.2 Maintenance Bypass Module (MBM)

The optional MBM is installed on the UPS rear panel and is used to bypass the UPS during maintenance or servicing. The maintenance bypass switch on the MBM provides a Make-Before-Break (MBB) wrap-around bypass for UPS service without shutting down the load.

1.1.3 Power Distribution Module (PDM)

The optional PDM provides the same functionality as the MBM and also comes equipped with several different types of output receptacles.

1.1.4 Bypass Power Module

The Eaton Bypass Power Module (BPM) is designed to be a maintenance bypass switch that also contains flexible output power distribution and mounting options.

The BPM provides added reliability to Eaton uninterruptible power supply (UPS) systems by ensuring seamless, uninterrupted, no-break transfer as well as a lock-out/tag-out (LOTO) feature to ensure the greatest safety for UPS technicians and electricians. The BPM also offers output distribution in order to simplify wiring in a rackmount IT environment, potentially removing the need for a panelboard, breakers, and conduit for distribution.

1.1.5 Input Isolation Transformer

The optional input isolation transformer is located at the bottom of a 3-high UPS model. The input isolation transformer provides a neutral from a 208V or 240V input source with 240V output and can be wired to the UPS or to an MBM/PDM.

1.1.6 Seismic Kit

The optional seismic kit secures the UPS and optional EBMs for Zone 4 seismic installations.

1.2 Using This Manual

This manual describes how to install and operate the Eaton 9155 UPS. Read and understand the procedures described in this manual to ensure trouble-free installation and operation. In particular, be thoroughly familiar with the REPO procedure or the LOAD OFF procedure, see **Chapter 5 UPS Operating Instructions**.

The information in this manual is divided into sections and chapters. The system, options, and accessories being installed dictate which parts of this manual should be read. At a minimum, **Chapter 1 Introduction** through **Chapter 4 Parallel UPS System Installation** and **Chapter 5 UPS Operating Instructions** should be examined.

Read through each procedure before beginning the work. Perform only those procedures that apply to the UPS system being installed or operated.

1.3 Conventions Used in This Manual

This manual uses these type conventions:

- **Bold type** highlights important concepts in discussions, key terms in procedures, and menu options, or represents a command or option that you type or enter at a prompt.
- Italic type highlights notes and new terms where they are defined.
- `Screen type` represents information that appears on the screen or LCD.

Icon	Description
Note	Information notes call attention to important features or instructions.
[Keys]	Brackets are used when referring to a specific key, such as [Enter] or [Ctrl].

In this manual, the term UPS refers only to the UPS cabinet and its internal elements. The term UPS system refers to the entire power protection system – the UPS cabinet, an external battery system, and options or accessories installed.

The term line-up-and-match refers to accessory cabinets that are physically located adjacent to the UPS. The term standalone refers to accessory cabinets that are located separate from the UPS.

Left and right side notations are referenced standing in front of the cabinet.

1.4 For More Information

Refer to the **Eaton 9155 UPS 8-15 kVA User's Guide** for the following additional information:

- Installation instructions, including site preparation, planning for installation, wiring and safety information, and detailed illustrations of cabinets with dimensional and connection point drawings
- Operation, including breakers, standard features and optional accessories, procedures for using the bypass functions, and information about maintenance

Refer to the **Eaton Bypass Power Module (BPM) User's Guide** for the following additional information:

- Installation instructions, wiring and safety information, and detailed illustrations with dimensional and connection point drawings
- Operation, standard features and information about maintenance

Refer to the **Eaton Remote Monitoring Device (RMD) Installation and Operation Manual** for additional installation and operating instructions.

- Visit www.eaton.com/powerquality or contact an Eaton service representative for information on how to obtain copies of these manuals.

1.5 Getting Help

If help is needed with any of the following:

- Scheduling initial startup
- Regional locations and telephone numbers
- A question about any of the information in this manual
- A question this manual does not answer

Please call the Customer Reliability Center at:

United States: **1-800-843-9433**
Canada: **1-800-461-9166 ext 260**
All other countries: **Call your local service representative**

Please have the following information ready when you call for service:

- Model number
- Serial number
- Firmware version number
- Date of failure or problem
- Symptoms of failure or problem
- Customer return address and contact information

Please use the following e-mail address for manual comments, suggestions, or to report an error in this manual:

E-ESSDocumentation@eaton.com

1.6 Equipment Registration

Please visit www.eaton.com/pq/register to register your new Eaton UPS / Eaton UPS Accessory.

Model Number:

Serial Number:

Chapter 2 Safety Warnings

IMPORTANT SAFETY INSTRUCTIONS SAVE THESE INSTRUCTIONS

This manual contains important instructions that you should follow during installation and maintenance of the UPS and batteries. Please read all instructions before operating the equipment and save this manual for future reference.



DANGER

This UPS contains LETHAL VOLTAGES. All repairs and service should be performed by AUTHORIZED SERVICE PERSONNEL ONLY. There are NO USER SERVICEABLE PARTS inside the UPS.



WARNING

- This UPS contains its own energy source (batteries). The UPS output may carry live voltage even when the UPS is not connected to an AC supply.
 - To reduce the risk of fire or electric shock, install this UPS in a temperature and humidity controlled, indoor environment, free of conductive contaminants. Ambient temperature must not exceed 40°C (104°F). Do not operate near water or excessive humidity (95% maximum).
 - To reduce the risk of fire, connect only to a circuit provided with 100 amperes maximum branch circuit overcurrent protection in accordance with the National Electrical Code® (NEC®), ANSI/NFPA 70.
 - Output overcurrent protection and disconnect switch must be provided by others.
-



CAUTION

- Batteries can present a risk of electrical shock or burn from high short circuit current. Observe proper precautions. Servicing should be performed by qualified service personnel knowledgeable of batteries and required precautions. Keep unauthorized personnel away from batteries.
 - Proper disposal of batteries is required. Refer to your local codes for disposal requirements.
 - Never dispose of batteries in a fire. Batteries may explode when exposed to flame.
-

2.1 Consignes de Sécurité

2.1.1 CONSIGNES DE SÉCURITÉ IMPORTANTES CONSERVER CES INSTRUCTIONS



IMPORTANT

Cet manuel comporte des instructions importantes que vous êtes invité à suivre lors de toute procédure d'installation et de maintenance des batteries et de l'onduleur. Veuillez consulter entièrement ces instructions avant de faire fonctionner l'équipement et conserver ce manuel afin de pouvoir vous y reporter ultérieurement.



DANGER!

Cet onduleur contient des TENSIONS MORTELLES. Toute opération d'entretien et de réparation doit être EXCLUSIVEMENT CONFIEE A UN PERSONNEL QUALIFIE AGRÉÉ. AUCUNE PIÈCE RÉPARABLE PAR L'UTILISATEUR ne se trouve dans l'onduleur.



AVERTISSEMENT!

- Cet onduleur renferme sa propre source d'énergie (batteries). Les prises de sortie peuvent être sous tension même lorsque l'onduleur n'est pas branché sur le secteur.
 - Pour réduire les risques d'incendie et de décharge électrique, installer l'onduleur uniquement à l'intérieur, dans un lieu dépourvu de matériaux conducteurs, où la température et l'humidité ambiantes sont contrôlées. La température ambiante ne doit pas dépasser 40 °C. Ne pas utiliser à proximité d'eau ou dans une atmosphère excessivement humide (95 % maximum).
 - La protection contre une surintensité pour le(s) circuit(s) de sortie de courant alternatif doit être fournie par un autre fournisseur.
 - Les interrupteurs de déconnexion convenables pour le(s) circuit(s) de sortie de courant alternatif doivent être fournis par un autre fournisseur.
-



ATTENTION!

- Les batteries peuvent présenter un risque de décharge électrique ou de brûlure par des courts-circuits de haute intensité. Prendre les précautions nécessaires.
 - Une mise au rebut réglementaire des batteries est obligatoire. Consulter les règlements en vigueur dans votre localité.
 - Ne jamais jeter les batteries au feu. L'exposition aux flammes risque de les faire exploser.
-

2.2 Advertencias de Seguridad

2.2.1 INSTRUCCIONES DE SEGURIDAD IMPORTANTES GUARDE ESTAS INSTRUCCIONES



IMPORTANT

Este manual contiene instrucciones importantes que debe seguir durante la instalación y el mantenimiento del SIE y de las baterías. Por favor, lea todas las instrucciones antes de poner en funcionamiento el equipo y guarde este manual para referencia en el futuro.



PELIGRO

Este SIE contiene VOLTAJES MORTALES. Todas las reparaciones y el servicio técnico deben ser efectuados SOLAMENTE POR PERSONAL DE SERVICIO TÉCNICO AUTORIZADO. No hay NINGUNA PARTE QUE EL USUARIO PUEDA REPARAR dentro del SIE.



WARNING

- Este SIE contiene su propia fuente de energía (las baterías). Los receptáculos de salida pueden transmitir corriente eléctrica aun cuando el SIE no esté conectado a un suministro de corriente alterna (c.a.).
- Para reducir el riesgo de incendio o de choque eléctrico, instale este SIE en un lugar cubierto, con temperatura y humedad controladas, libre de contaminantes conductores. La temperatura ambiente no debe exceder los 40°C. No trabaje cerca del agua o con humedad excesiva (95% máximo).
- La protección contra exceso de corriente para el/los circuito(s) de CA de salida será suministrada por terceros.
- Los interruptores de desconexión debidamente clasificados para el/los circuito(s) de CA de salida serán suministrados por terceros.



PRECAUCIÓN

- Las baterías pueden presentar un riesgo de descargas eléctricas o de quemaduras debido a la alta corriente de cortocircuito. Preste atención a las instrucciones correspondientes.
- Es necesario desechar las baterías de un modo adecuado. Consulte las normas locales para conocer los requisitos pertinentes.
- Nunca deseche las baterías en el fuego. Las baterías pueden explotar si se las expone a la llama.

Safety Warnings

Chapter 3 UPS Installation Plan and Unpacking

Use the following basic sequence of steps to install the UPS:

1. Create an installation plan for the UPS system.
2. Prepare your site for the UPS system.
3. Inspect and unpack the UPS cabinet.
4. Unload and install the UPS cabinet, and wire the system.
5. Complete the Installation Checklist.
6. Have authorized service personnel perform preliminary operational checks and start up the system.

The instructions are intended for the chief operator/system supervisor, electrical consultants, and installation electricians. Local regulations and electrical code must be followed during the UPS installation.

3.1 Creating an Installation Plan

Before installing the UPS system, read and understand how this manual applies to the system being installed. Use this chapter's procedures and illustrations and those in **Chapter 4 UPS System Installation** to create a logical plan for installing the system.

3.2 Preparing the Site

For the UPS system to operate at peak efficiency, the installation site should meet the environmental parameters outlined in this manual. The operating environment must meet the weight, clearance, and environmental requirements specified.

3.2.1 Environmental and Installation Considerations

The UPS system installation must meet the following guidelines:

- The system must be installed on a level floor suitable for computer or electronic equipment.
- The system must be operated at an altitude no higher than 1500m (5000 ft) without derating. For additional assistance with high altitude operation, contact an Eaton service representative (see paragraph [1.5 Getting Help](#)).
- The system must be installed in a temperature and humidity controlled indoor area free of conductive contaminants.



CAUTION

Do not expose the UPS to overly aggressive environments, like salt mist or corrosive gases. High relative humidity accelerates the effects of contaminants. The UPS should be installed in a G1 environment (based on ANSI/ISA S-71.04 classifications). If the UPS is used in a more aggressive environment, it can cause reduced product life and possibly early failure. If the installation location does not meet the recommended environment, contact Eaton service representative for further information (see paragraph [1.5 Getting Help](#)).

- The environmental requirements specified below are for the air at the intake ports of the 9155 UPS, and are the maximum, not to exceed, ratings.
 - There shall be at least a 1.8°F (1.0°C) difference between the dry bulb temperature and the wet bulb temperature, at all times, to maintain a non-condensing environment.
 - The maximum rate of temperature change shall be limited to 3°F over 5 minutes (36°F/hour), based on the ASHRAE Standard 90.1-2013.

- The newer, more energy efficient data center cooling methods (such as air side economization) can create much wider ranges of temperature and Relative Humidity (RH) in the UPS room and/or data center. There are two aspects of this increased operating environment that can, if ignored, create issues.
 - One is the creation of microclimates, which are persistent variations of temperature and/or RH within a single room. For example one side of the room is always cooler than the other side, no matter the actual temperature.
 - The other aspect is the rate of change of temperature and/or RH, which can occur during transitions within the cooling system. Examples: changing the mixture ratio of inside versus outside air, or external changes in the outside air when going from night to day, and back to night.
 - When ignored, either one of these aspects can create an undesirable microclimate at the UPS location. If the environment created by this microclimate exceeds the UPS operating specification, the UPS reliability, over time, will be reduced. These same environmental extremes will also create reliability concerns for any servers that are exposed to them.

Failure to follow guidelines may void your warranty.

The basic environmental requirements for operation of the UPS are:

- Ambient Temperature Range: 5–40°C (41–104°F)
- Recommended Operating Range: 5–40°C (41–104°F)
- Maximum Relative Humidity: 5–95%, noncondensing

 **CAUTION**

If battery systems are located in the same room as the UPS, the battery manufacturer's environmental requirements should be followed if they are more stringent than the UPS requirements. Operating temperatures above the recommended range will result in decreased battery life and performance, and may reduce or void the battery warranty.

The UPS ventilation requirements are shown in [Table 1](#). To allow for future power upgrades, Eaton recommends using air conditioning or ventilation sized for the fully rated UPS kVA installed instead of the derated kVA ordered. Sizing the site cooling infrastructure to be capable of cooling the maximum kVA size will allow a full power rating upgrade without having to modify the infrastructure.

Table 1. Air Conditioning or Ventilation Requirements During Full Load Operation

Model	UPS Rating	Minimum Required Cooling Air Flow
Eaton 9155 UPS	8–15 kVA	129 liter/sec (274 cfm)

The UPS equipment operating environment must meet the weight requirements shown in [Table 2](#) and the size requirements shown in [Table 3](#).

When planning the installation, consider the UPS weight for floor loading. The strength of the installation surface must be adequate for point and distributed loadings. The approximate weights are shown in the following table.

Table 2. UPS Cabinet Weights

Standard Model Floor Loadings (2-High/3-High Cabinets)			
Eaton 9155 UPS	Maximum Weight (lb)	Point Loading lb/in ²	Distributed Loading (lb/ft ²)
2-High UPS	352	88	166
3-High UPS	590	148	278
3-High UPS with Isolation Transformer	558	140	263
2-High EBM	480	120	226
3-High EBM	710	178	335

The UPS cabinet uses forced air cooling to regulate internal component temperature. Allow clearance in front of and in back of the cabinet for proper air circulation. The clearances required around the UPS cabinet are shown in the following table.

Table 3. UPS Cabinet Clearances

From Front of Cabinet	36" (91.4 cm) working space
From Back of Cabinet	6" (15.2 cm) without an MBM/PDM installed; with an MBM/PDM installed, clearance is determined by the customer-supplied mating

**NOTE**

For full UPS and EBM cabinet dimensions and Center of Gravity measurements, see *Eaton 9155 UPS 8–15 kVA User's Guide*.

3.3 UPS System Power Wiring Preparation

Read and understand the following notes while planning and performing the installation:

**WARNING**

As a result of the connected loads high leakage current is possible. Connection to earth ground is required for safety and proper product operation. Do not check UPS operation by any action that includes removal of the earth (ground) connection with loads attached.

- Refer to national and local electrical codes for acceptable external wiring practices.
- For external wiring, use 90°C copper wire.

**IMPORTANT**

This product has been evaluated for use with **copper wire only**. For external wiring, use only 90°C copper wire.

Wire sizes listed in [Table 4](#) through [Table 6](#) are for copper wiring only. If wire is run in an ambient temperature greater than 40°C, larger size wire may be necessary. Wire sizes are based on using the specified breakers.

- Recommended wire sizes are based on NFPA National Electrical Code® (NEC®)70 Table 310.15(B)(16) 90° C ampacity with 40°C ambient correction factors.

- Input neutral must be wired for proper operation. Failure to connect an input neutral will void the warranty. If the optional input transformer is installed, an input neutral is not required.
- The Eaton 9155 UPS is a single-feed UPS only.

Table 4. UPS Terminal Block (TB1) Wiring

Wire Function		Terminal Position	Input Circuit Breaker Rating		Minimum Wire Size*	Tightening Torque	Conduit Connection (Entry Size)
Input	Ground	TB1-1			8 AWG	25 lb in (2.83 Nm)	2" access hole for 1-1/2" conduit
	AUX	TB1-2-1 and 2-2			—		
	Not Used	TB1-2A-1 and 2A-2			—		
	L1	TB1-3	8 kVA	60A	4 AWG (21.2 mm ²)		
	Neutral	TB1-4	10 kVA	80A	3 AWG (26.7 mm ²)		
	L2	TB1-5	12 kVA	100A	2 AWG (33.6 mm ²)		
Output	L1	TB1-6			8 AWG	25 lb in (2.83 Nm)	2" access hole for 1-1/2" conduit
	Neutral	TB1-7			8 AWG		
	L2	TB1-8			8 AWG		
	Not Used	TB1-8A-1 and 8A-2			—		
	Ground	TB1-9			8 AWG		

* Use only 75°C-rated copper wire. Minimum wire size is based on 120/208 full load ratings applied to NEC Code Table 310-16. Code may require a larger AWG size than shown in this table because of temperature, number of conductors in the conduit, or long service runs. Follow local requirements.

Table 5. Input Isolation Transformer Terminal Block Wiring

Wire Function	Terminal Position	Input Circuit Breaker Rating		Minimum Wire Size*	Tightening Torque	
Input	L1	TB1-1	8 kVa	60A	3 AWG (26.7 mm ²)	25 lb in (2.83 Nm)
	L2 (208V)	TB1-2	10 kVA	80A	2 AWG (33.6 mm ²)	
	L2 (240V)	TB1-3	12 kVA	100A	1 AWG (42.4 mm ²)	
			15 kVA	100A	1 AWG (42.4 mm ²)	
Output	L1	TB1-4	8 kVA		4 AWG (21.2 mm ²)	25 lb in (2.83 Nm)
	L2	TB1-5	10 kVA		3 AWG (26.7 mm ²)	
			12 kVA		2 AWG (33.6 mm ²)	
	Neutral	TB1-6	15 kVA		2 AWG (33.6 mm ²)	
Ground	Output	TB1-7			8 AWG	25 lb in (2.83 Nm)
	Input	TB1-8				

* Use only 75°C-rated copper wire. Minimum wire size is based on 120/208 full load ratings applied to NEC Code Table 310-16. Code may require a larger AWG size than shown in this table because of temperature, number of conductors in the conduit, or long service runs. Follow local requirements.

Table 6. MBM/PDM Terminal Block (TB10) Wiring

Wire Function		Input Circuit Breaker Rating		Minimum Wire Size*	Tightening Torque	Conduit Connection (Entry Size)
Input	Ground			8 AWG		
	L1	8 kVa	60A	4 AWG (21.2 mm ²)	120 lb in (13.5 Nm)	2" access hole for 1-1/2" conduit
	Neu- tral	10 kVA	80A	3 AWG (26.7 mm ²)		
		12 kVA	100A	2 AWG (33.6 mm ²)		
	L2	15 kVA	100A	2 AWG (33.6 mm ²)		
Output	L1			3 AWG		
	Neu- tral			3 AWG	120 lb in (13.5 Nm)	2" access hole for 1-1/2" conduit
	L2			3 AWG		
	Ground			8 AWG		

* Use only 75°C-rated copper wire. Minimum wire size is based on 120/208 full load ratings applied to NEC Code Table 310-16. Code may require a larger AWG size than shown in this table because of temperature, number of conductors in the conduit, or long service runs. Follow local requirements.

3.4 Inspecting and Unpacking the Equipment

The cabinet is shipped bolted to a metal and wood pallet with outer protective packaging material covering the cabinets.

- Carefully inspect the outer packaging for evidence of damage during transit.



CAUTION

Do not install a damaged cabinet. Report any damage to the carrier and contact an Eaton service representative immediately.



NOTE

Check the battery recharge date on the packaging label. If the date has expired and the batteries were never recharged, do not use the UPS. Contact your service representative.

- Use a forklift or pallet jack to move the packaged cabinet to the installation site, or as close as possible, before unpacking. If possible, move the cabinet using the pallet. Insert the forklift or pallet jack forks between the supports on the bottom of the pallet.
- Set the pallet on a firm, level surface, allowing a minimum clearance of 3m (10 ft) on each side for removing the cabinet from the pallet.
- Remove the protective packaging material from the cabinet and recycle in a responsible manner. Retain any parts kits packaged with the cabinet.
- Inspect the contents for any evidence of physical damage, and compare each item with the Bill of Lading. If damage has occurred or shortages are evident, contact an Eaton service representative immediately to determine the extent of the damage and its impact on further installation.

If any equipment has been damaged during shipment, keep the shipping and packing materials for the carrier or place of purchase and file a claim for shipping damage. If you discover damage after acceptance, file a claim for concealed damage.

To file a claim for shipping damage or concealed damage: 1) File with the carrier within 15 days of receipt of the equipment; 2) Send a copy of the damage claim within 15 days to your service representative.

**NOTE**

While waiting for installation, protect the unpacked cabinet from moisture, dust, and other harmful contaminants. Failure to store and protect the UPS properly may void the warranty.

**NOTE**

Check the battery recharge date on the packaging label. If the date has expired and the batteries were never recharged, do not use the UPS. Contact your service representative.

Chapter 4 Parallel UPS System Installation

4.1 Preliminary Installation Information



WARNING

Installation should be performed only by qualified personnel.

Refer to the following while installing the UPS system:

- Review **Chapter 3 UPS Installation Plan and Unpacking**, for cabinet dimensions, equipment weight, wiring and terminal data, and installation notes.
- Do not tilt the cabinets more than $\pm 10^\circ$ during installation.
- Remove conduit landing plates to add conduit landing holes as required.
- If perforated floor tiles are required for ventilation, place them in front of the UPS.

4.2 Unloading the UPS Cabinet from the Pallet

The following tools are required for unloading the cabinet(s):

- 15 mm wrench or socket
- 7 mm nutdriver or socket



CAUTION

The UPS and Extended Battery Module (EBM) are heavy (see [Table 2](#)). Unloading the cabinets requires at least two people to safely remove the cabinets from the pallet.

To remove the UPS or EBM from the shipping pallet:

1. Remove the two M10 bolts securing the stabilizing bracket to the pallet (see [Figure 2](#)).

Figure 2. Removing the Stabilizing Bracket Bolts

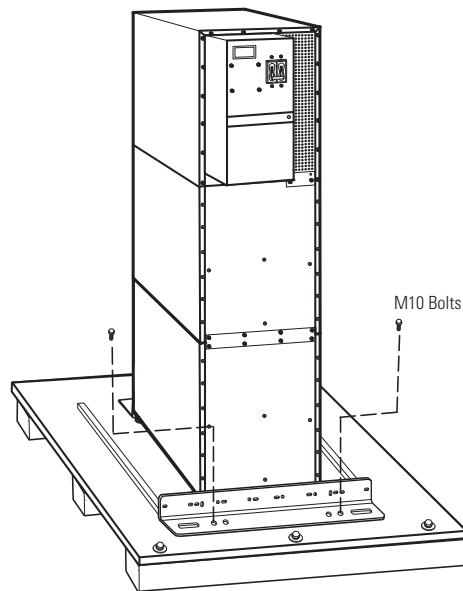

2. Remove the M10 bolts from the two Pallet Brackets securing the leveling feet to the pallet (see [Figure 3](#)).
3. Remove the four M4 screws securing the stabilizing bracket to the cabinet rear panel and remove the bracket (see [Figure 3](#)). Retain the hardware for later use.



NOTE

Be sure to retain the stabilizing bracket and hardware for later re-assembly onto the cabinet.

4. Remove the front cover from the bottom cabinet to access the front shipping bracket.
Press and release the handle latch at the bottom of the cover and then lift the cover up and off the cabinet.
5. Remove the three M10 bolts securing the rear shipping pad to the pallet and remove the shipping pad (see [Figure 3](#)).



NOTE

Hold the back of the cabinet so that the bolts can be removed easily without the cabinet rolling backward.

6. Remove the two M10 bolts securing the front shipping bracket and remove the bracket (see [Figure 3](#)).
If needed, adjust the leveling feet to release the bracket.

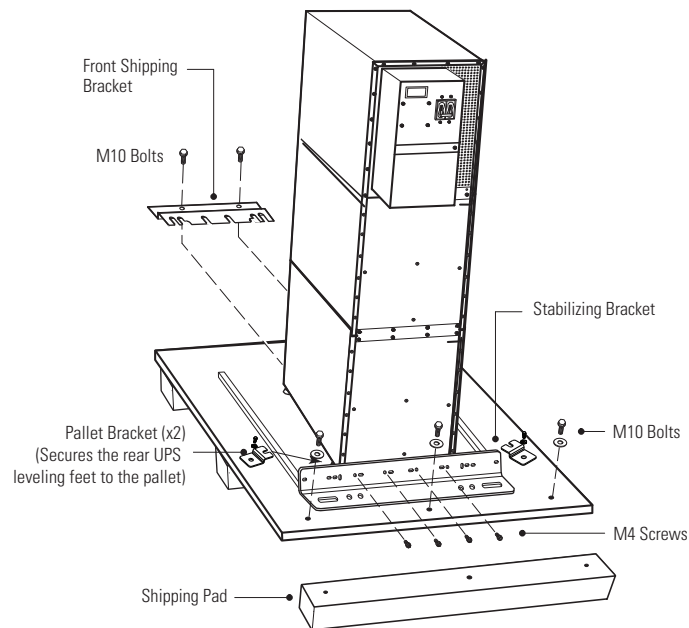
Figure 3. Removing the Brackets and Shipping Pad

7. Reinstall the front cover removed in [Step 4](#).

Hang the top edge of the cover on the cabinet first, then lower the bottom edge and snap into place.

**NOTE**

Be sure to support the front and back of the cabinet when rolling it off the pallet to prevent tipping.

8. Slowly roll the cabinet toward the rear of the pallet. Once the pallet tilts, continue rolling the cabinet down the pallet until the cabinet touches the floor (see [Figure 4](#)).

If needed, adjust the leveling feet so that the cabinet will roll.

Figure 4. Unloading the Cabinet

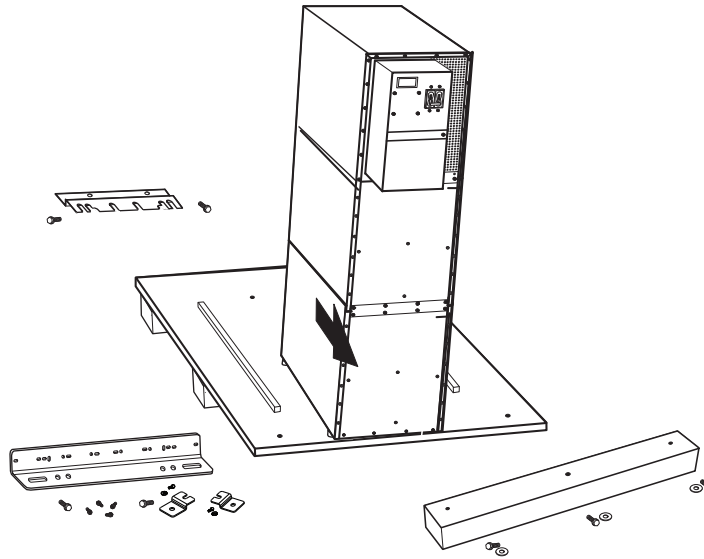

9. With the cabinet supported, slowly pull the pallet away from the cabinet (see [Figure 5](#)).

Figure 5. Removing the Pallet

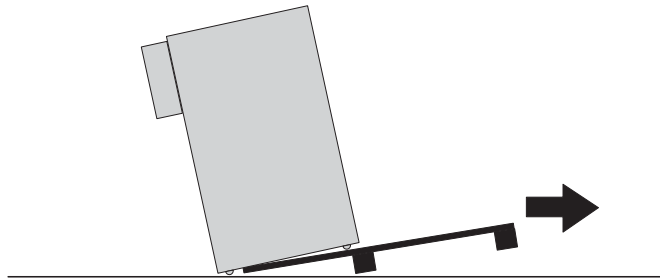

10. Roll the cabinet to the desired location.

4.3 Parallel Installation

The Eaton 9155 UPS has the following power connections:

- 2-phase (L1 and L2), neutral, and ground connection for rectifier/bypass input
- 2-phase (L1 and L2), neutral, and ground connection for load output

The nominal input/output voltages are:

- 100/200, 110/220, or 120/240 Vac with 180° phase displacement

- 120/208 or 127/220 Vac with 120° phase displacement

Output overcurrent protection and disconnect switch must be provided by others.



WARNING

Only qualified service personnel (such as a licensed electrician) should perform the UPS installation. Initial startup must be performed by an authorized Eaton Customer Service Engineer. Risk of electrical shock.

To hardwire the UPS:

1. Verify that the electrical connections to the installation site have been properly installed.
2. A wall-mounted, user-supplied, readily-accessible disconnection device must be incorporated in the input wiring.

Compare the circuit breaker ratings to the ones in the following wiring table:

Table 7. Circuit Breaker Ratings

UPS Capacity	Input Circuit Breaker Rating	Minimum Wire Size*
8 kVA	60A	4 AWG (21.2 mm ²)
10 kVA	80A	3 AWG (26.7 mm ²)
12 kVA	100A	2 AWG (33.6 mm ²)
15 kVA	100A	2 AWG (33.6 mm ²)

*Use only 75°C -rated copper wire. Minimum wire size is based on 120/208 full load ratings applied to NEC Code Table 310-15(B)(16). Code may require a larger AWG size than shown in this table because of temperature, number of conductors in the conduit, or long service runs. Follow local requirements.



NOTE

To accommodate the feature of easy system expandability, it is recommended that initial installation of the Eaton 9155 UPS contain wiring to support the maximum capacity of the UPS cabinet.

3. Switch off utility power to the distribution point where the parallel tie cabinet and UPSs will be connected. Be absolutely sure there is no power.
4. Determine your equipment's grounding requirements according to your local electrical code.
5. Remove the parallel tie cabinet front cover (see [Figure 6](#)).

Figure 6. Parallel Tie Cabinet Front Cover

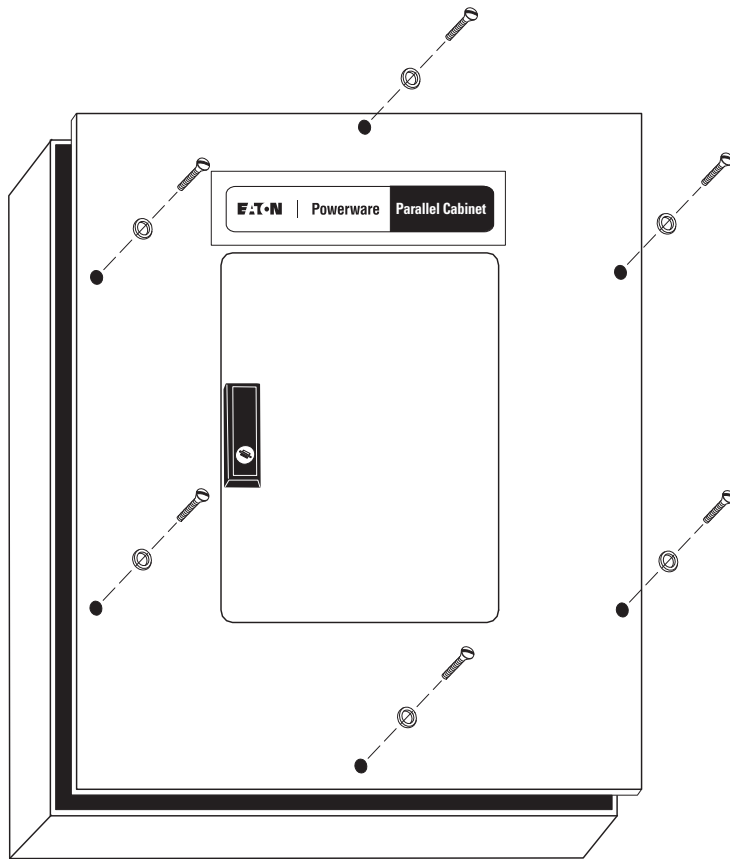

6. Remove the internal cover to gain access to the breakers (see [Figure 7](#)).

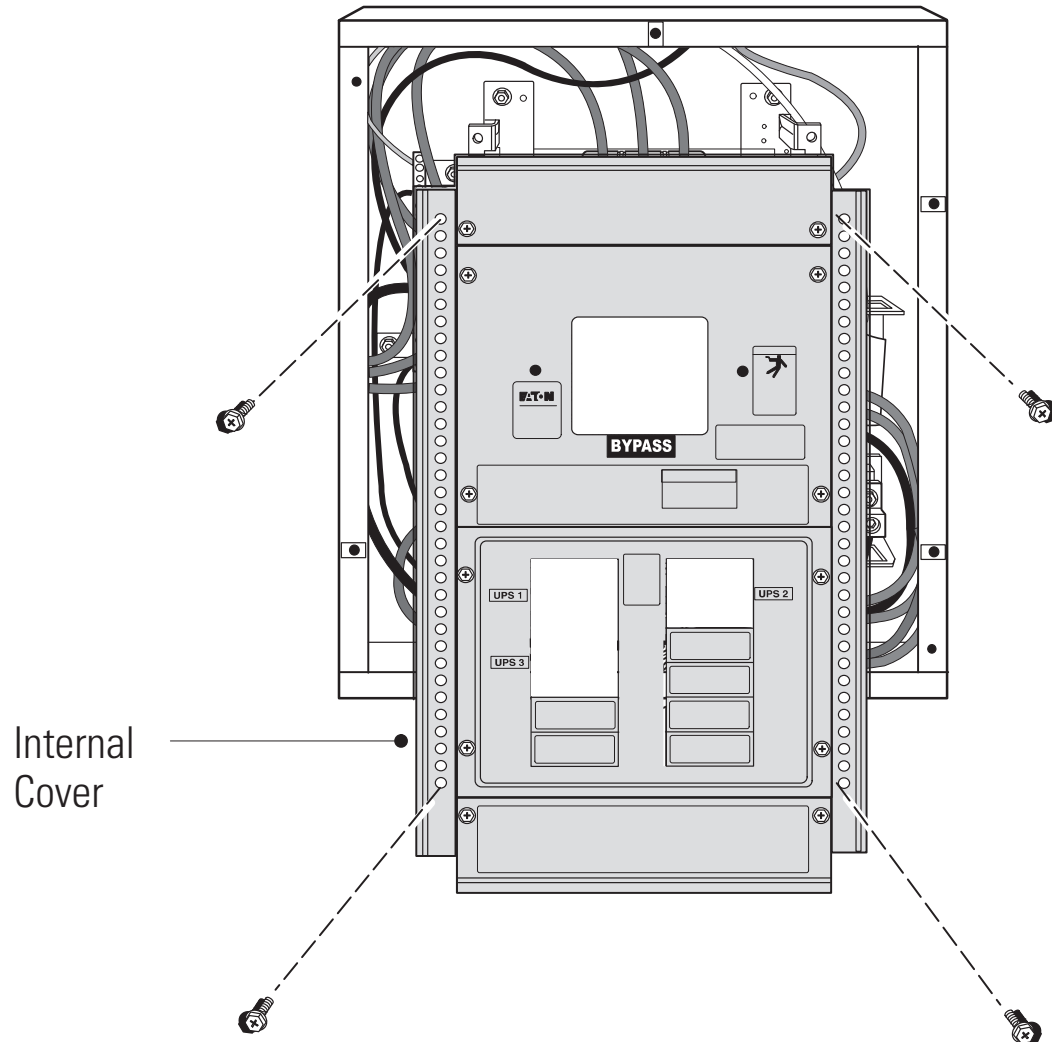
Figure 7. Internal Cover

7. Punch holes for the conduit (AC input, each UPS output, and load connection) using a Greenlee® punch or similar device.
8. Verify that the parallel bypass breaker is in the OFF position (see [Figure 8](#)).
9. Mount the parallel tie cabinet to the wall and install the conduit.

Figure 8. Parallel Bypass Breaker

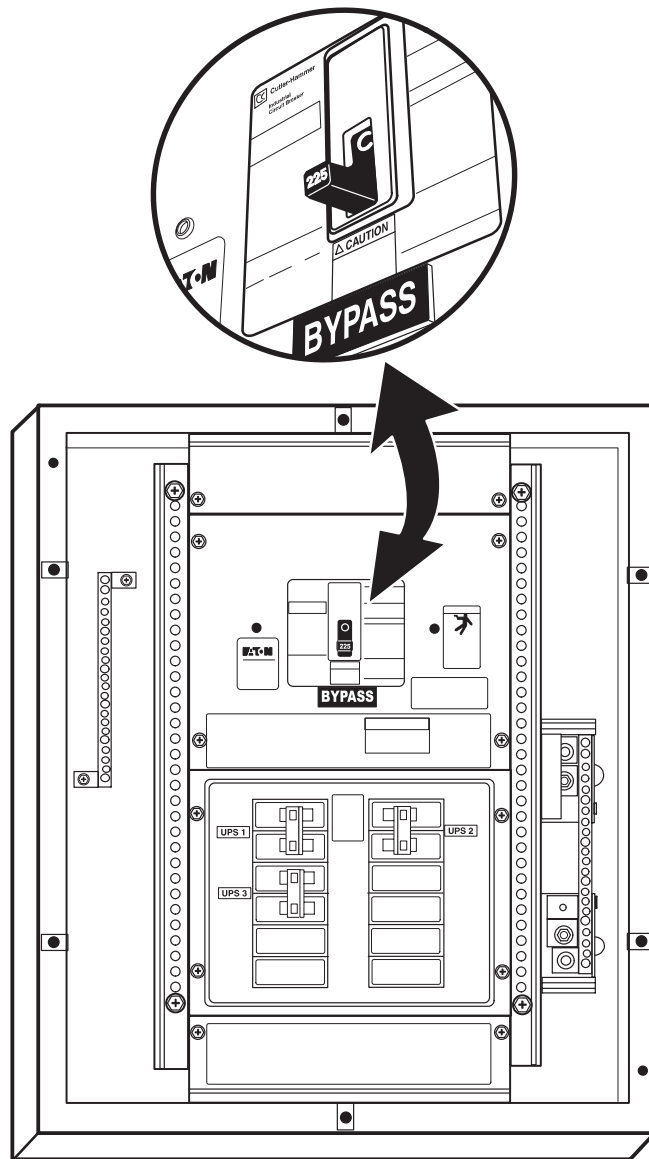

10. Verify that each UPS battery circuit breaker is in the OFF position (see [Figure 9](#)).

Figure 9. UPS Rear View (2-High Shown)

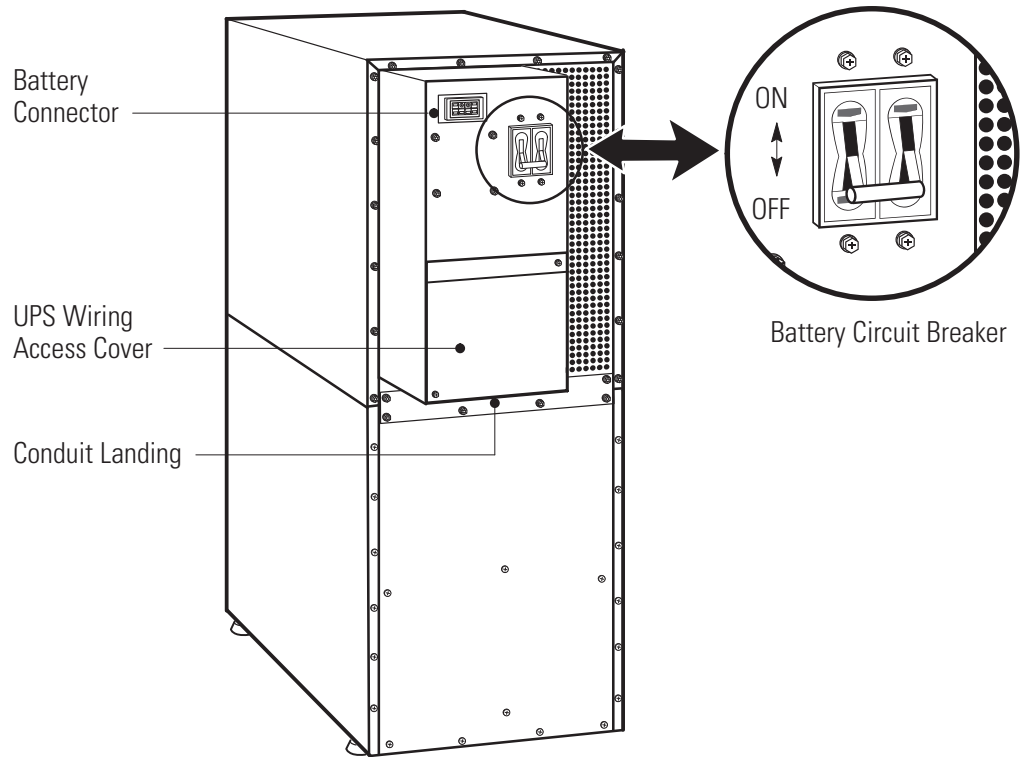

11. From each UPS, remove the UPS wiring access cover and retain (see [Figure 9](#)).
12. Hardwire the UPS input terminations (TB1-1 through TB1-5) for each UPS.
See [Table 8](#) for specifications and [Figure 10](#) for a detailed view of the UPS terminal block.

NOTE Input neutral must be wired for proper operation. Failure to connect an input neutral will void the warranty.

Table 8. Recommended Terminal Block Wiring

Wire Function		Terminal Position	Upstream Circuit Breaker	Minimum Wire Size*	Tightening Torque	Conduit Connection (Entry Size)
Input	Ground	TB1-1		8 AWG		
	L1	TB1-3	100A	3 AWG	25 lb in (2.83 Nm)	2" access hole for 1-1/2" conduit
	Neutral	TB1-4		3 AWG		
	L2	TB1-5	100A	3 AWG		
Output	L1	TB1-6		3 AWG	25 lb in (2.83 Nm)	2" access hole for 1-1/2" conduit
	Neutral	TB1-7		3 AWG		

Table 8. Recommended Terminal Block Wiring (Continued)

L2	TB1-8	3 AWG
Ground	TB1-9	8 AWG

*Use only 75°C-rated copper wire. Minimum wire size is based on 120/208 full load ratings applied to National Electrical Code (NEC) Table 310-15(B)(16).

Figure 10. UPS Terminal Block

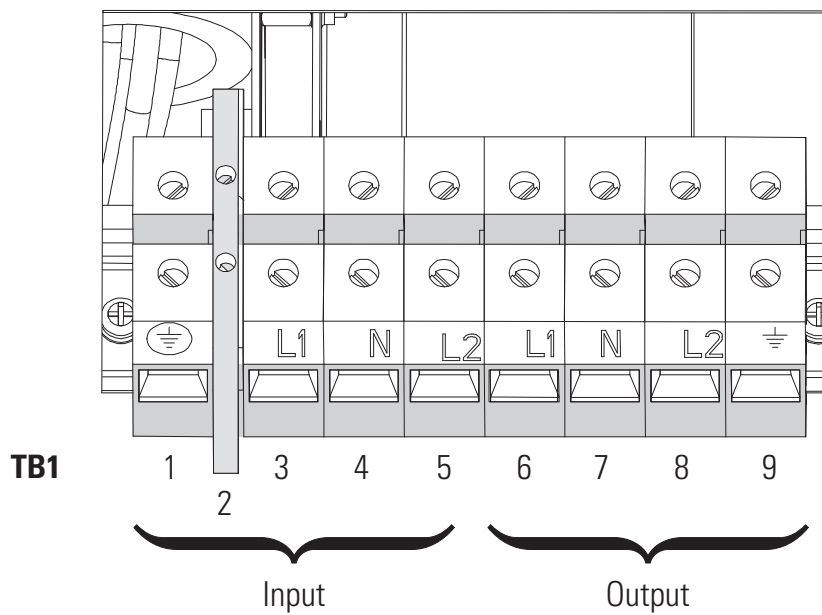

13. Hardwire the output terminations (TB1-6 through TB1-9) from each UPS to the parallel tie cabinet (see [Figure 11](#)).

Figure 11. UPS to Parallel Tie Cabinet Wiring

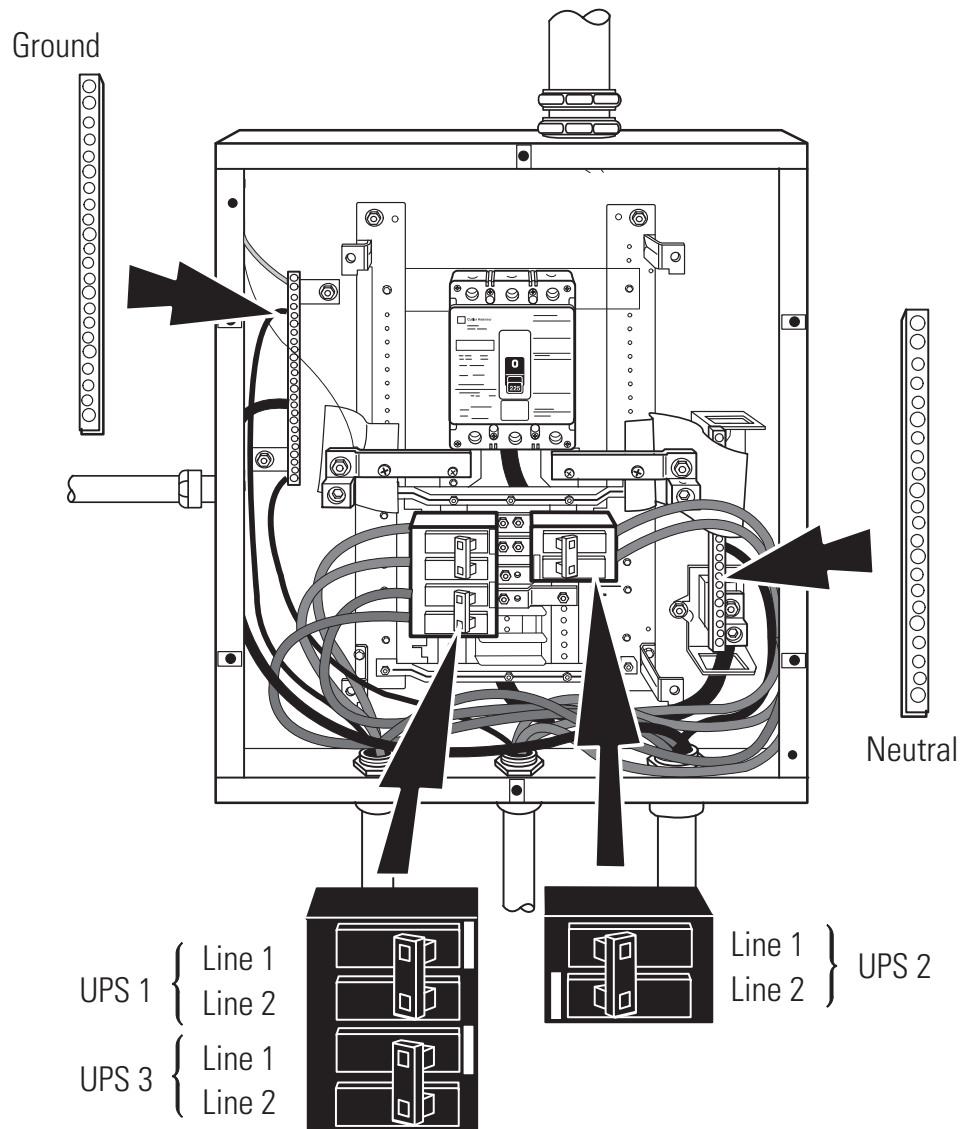

14. Replace each UPS wiring access cover.
15. Hardwire the load to the parallel tie cabinet (see [Figure 12](#)).

Figure 12. Load Connections

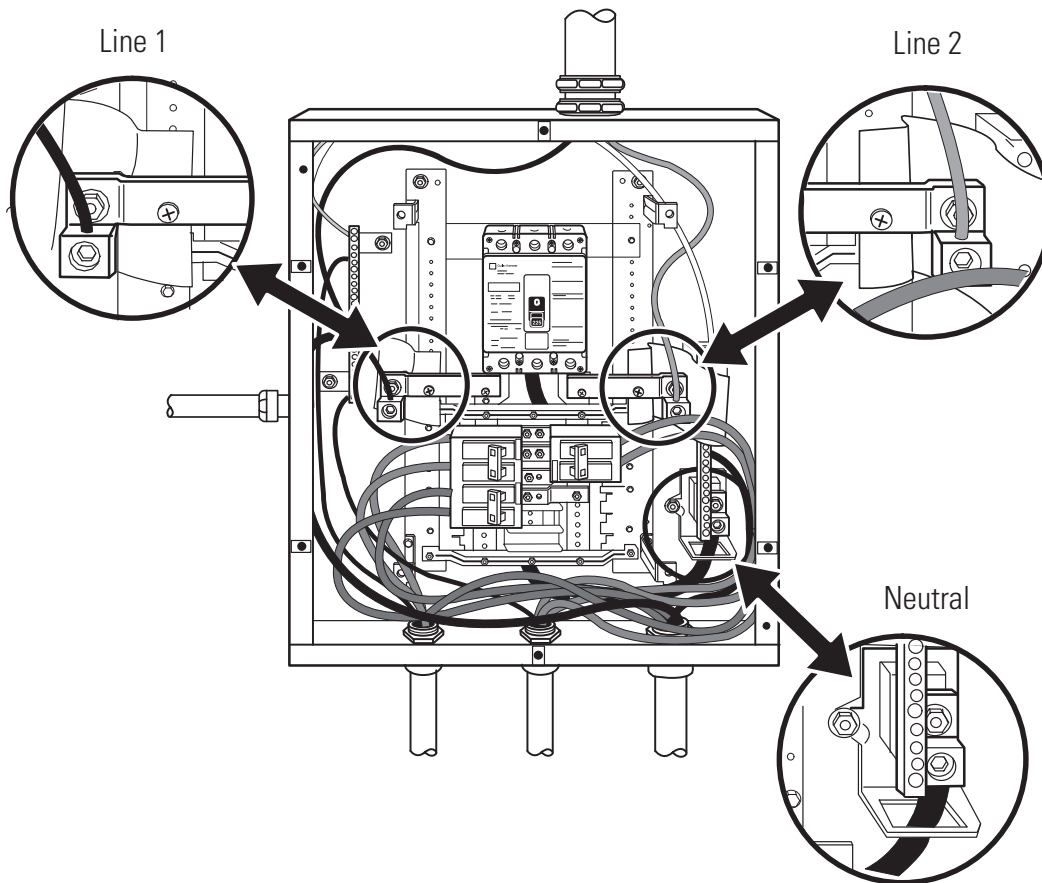

16. Wire the AC input to the bypass breaker (see [Figure 13](#)).

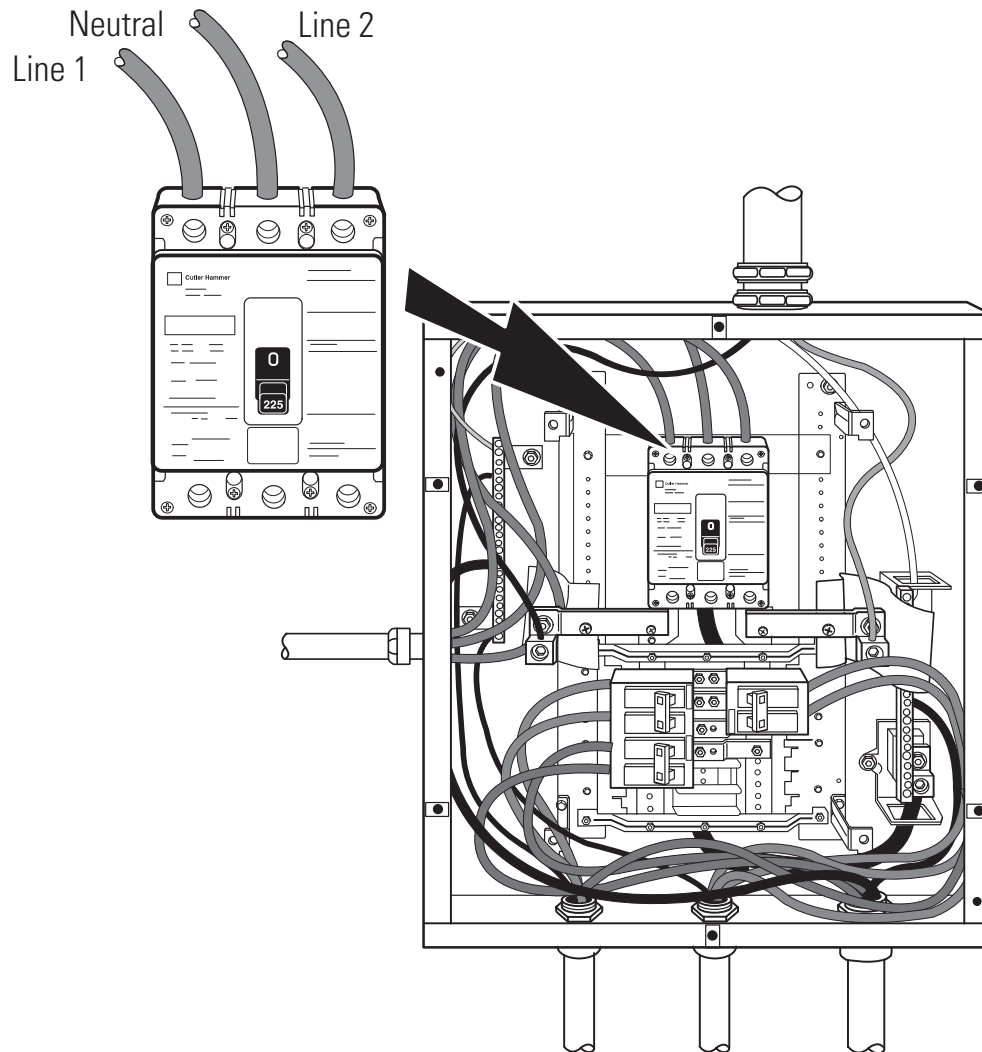
Figure 13. Parallel AC Input Wiring

17. Verify the phase rotation for each UPS and the bypass input.
18. Reinstall the internal cover removed in [Step 6](#).
19. Reinstall the parallel tie cabinet front cover removed in [Step 5](#).
20. Continue to paragraph [4.4 Installing Options](#).

Figure 14. Parallel Wiring Diagram

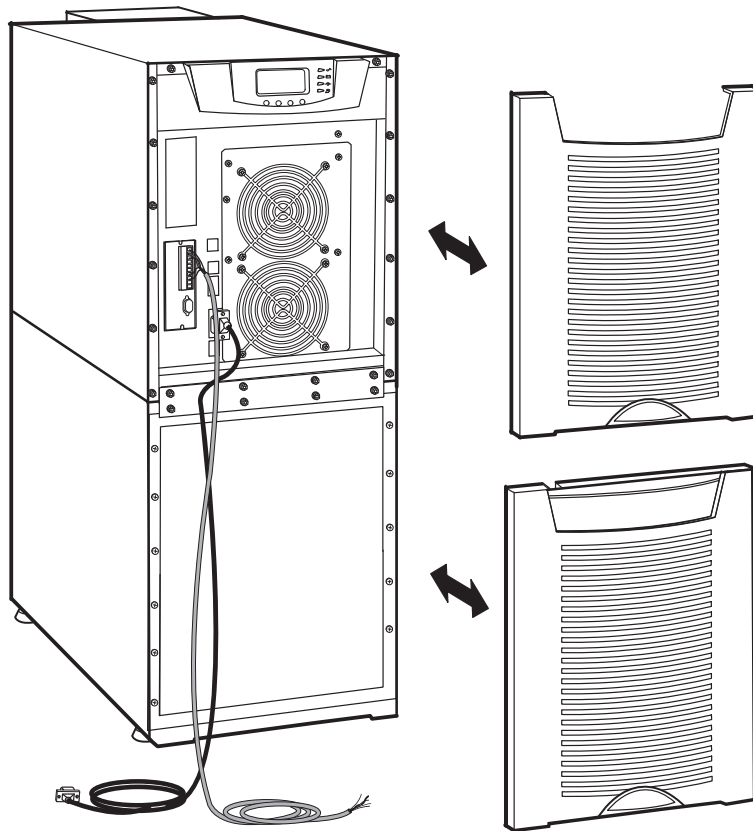

4.4 Installing Options

This section describes the Powerware Hot Sync CAN Bridge Card.

For other options, such as additional X-Slot® cards, power management software, remote emergency power-off (REPO), relay output contacts, or programmable signal inputs, refer to the *Eaton 9155 UPS (8–15 kVA) User's Guide*.

[Figure 15](#) shows the location of the communication options and control terminals on the UPS.

Figure 15. Communication Options and Control Terminals

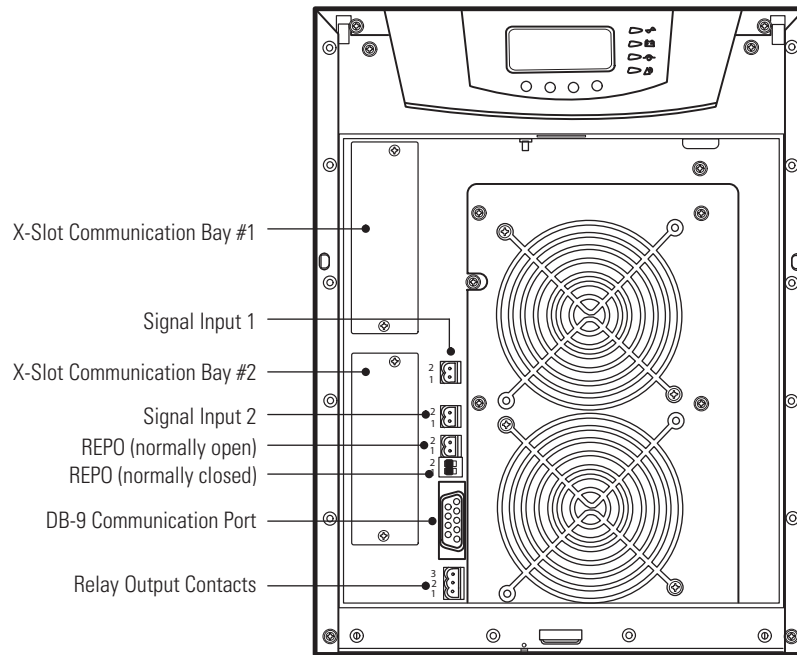

4.4.1 Powerware Hot Sync CAN Bridge Card

The Powerware Hot Sync CAN Bridge Card, shown in [Figure 16](#), can be installed to provide connectivity for operational mode control and metering of a parallel system at any UPS in the system.

Figure 16. Powerware Hot Sync CAN Bridge Card

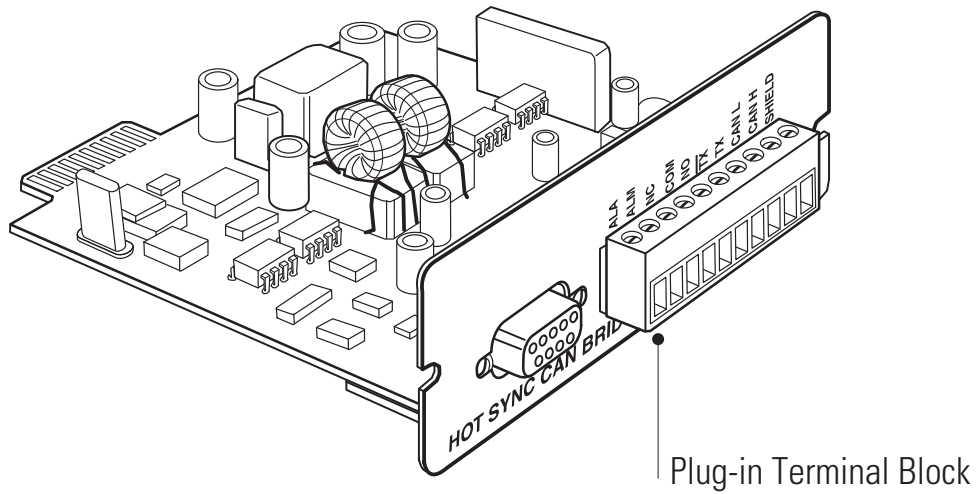

To install the Powerware Hot Sync CAN Bridge Card:

1. Remove the front covers of all cabinets, starting with the top cabinet.
Press and release the handle latch at the bottom of each cover and then lift the cover up and off the cabinet (see [Figure 17](#)).

Figure 17. Removing the Front Covers

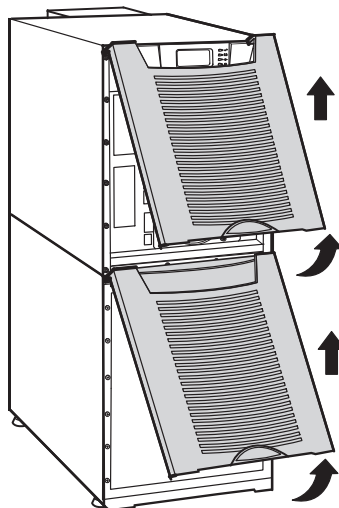

2. If you ordered a factory-configured parallel UPS, remove the Powerware Hot Sync CAN Bridge Card from the X-Slot on the front of the UPS. Retain the screws.
Otherwise, remove the X-Slot communication bay cover and retain the screws.
3. Set the jumper pins on the Powerware Hot Sync CAN Bridge Card according to the parallel configuration (see [Figure 18](#)):
 - If only two UPSs are paralleled, then set both cards to Pins 1 and 2.
 - For three paralleled UPSs, set the cards of the first and last UPS to Pins 1 and 2; set the card for the middle UPS to Pins 2 and 3.

Figure 18. Setting the CAN Bridge Card Jumper J7 (Side View)

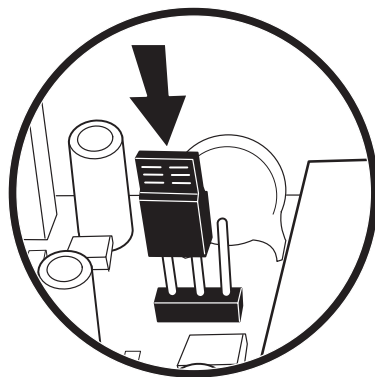

Jumper J7 - Pins 1 and 2

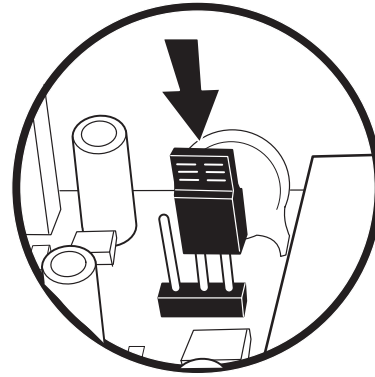

Jumper J7 - Pins 2 and 3

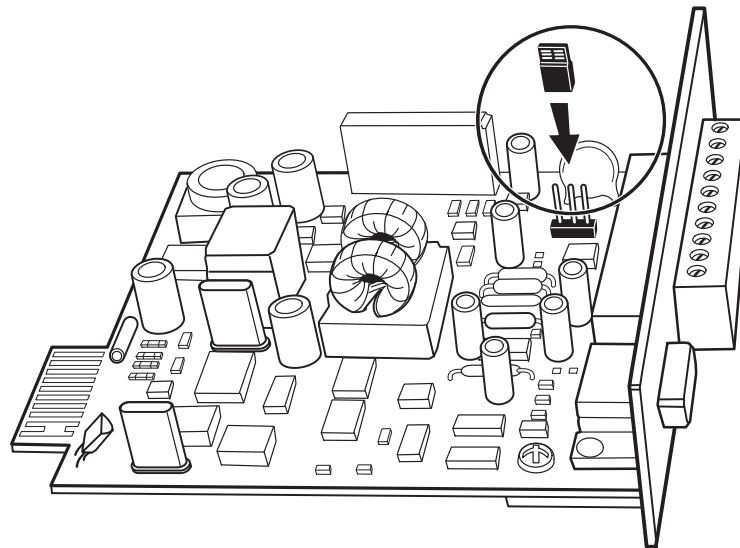

NOTE

If you are installing another X-Slot card, be sure to install the Powerware Hot Sync CAN Bridge Card in X-Slot 2.

4. Loosely install the Powerware Hot Sync CAN Bridge Card into an open X-Slot on the front of the UPS. You may want to remove the terminal block from the CAN Bridge Card for better wiring access.
5. Strip shielded, four-wire, twisted-pair wire for CAN Bridge Card wiring. Recommended wire size is 18 AWG maximum.
6. Install the CAN Bridge Card wiring between each UPS (see [Figure 19](#)). Be sure to check correct polarity for Pins 8 and 9:
 - Connect SHIELD Pin 10 on all cards together.
 - Connect CAN H Pin 9 and CAN L Pin 8 (twisted pair) on all cards together.
 - Connect COM Pin 4 and NC Pin 3 (twisted pair) on all cards together.
7. Install the pull-chain wiring between the CAN Bridge Card and Signal Input 2 on each UPS and daisy chain the wiring to each UPS. Be sure to check correct polarity (see [Figure 19](#)):
 - Connect COM Pin 4 to Signal Input 2 Pin 1 on each UPS.
 - Connect NC Pin 3 to Signal Input 2 Pin 2 on each UPS.

 **CAUTION**

If polarity or wiring is not correct, the parallel system does not operate normally. For example, when shutting down one UPS, the remaining UPS transfers the load to bypass instead of supporting the load. Verify all CAN Bridge Card wiring is correct for proper operation.



NOTE

Signal Input 2 can still be used for building alarms; it is automatically rerouted to the CAN Bridge Card.

Figure 19. CAN Bridge Card Wiring

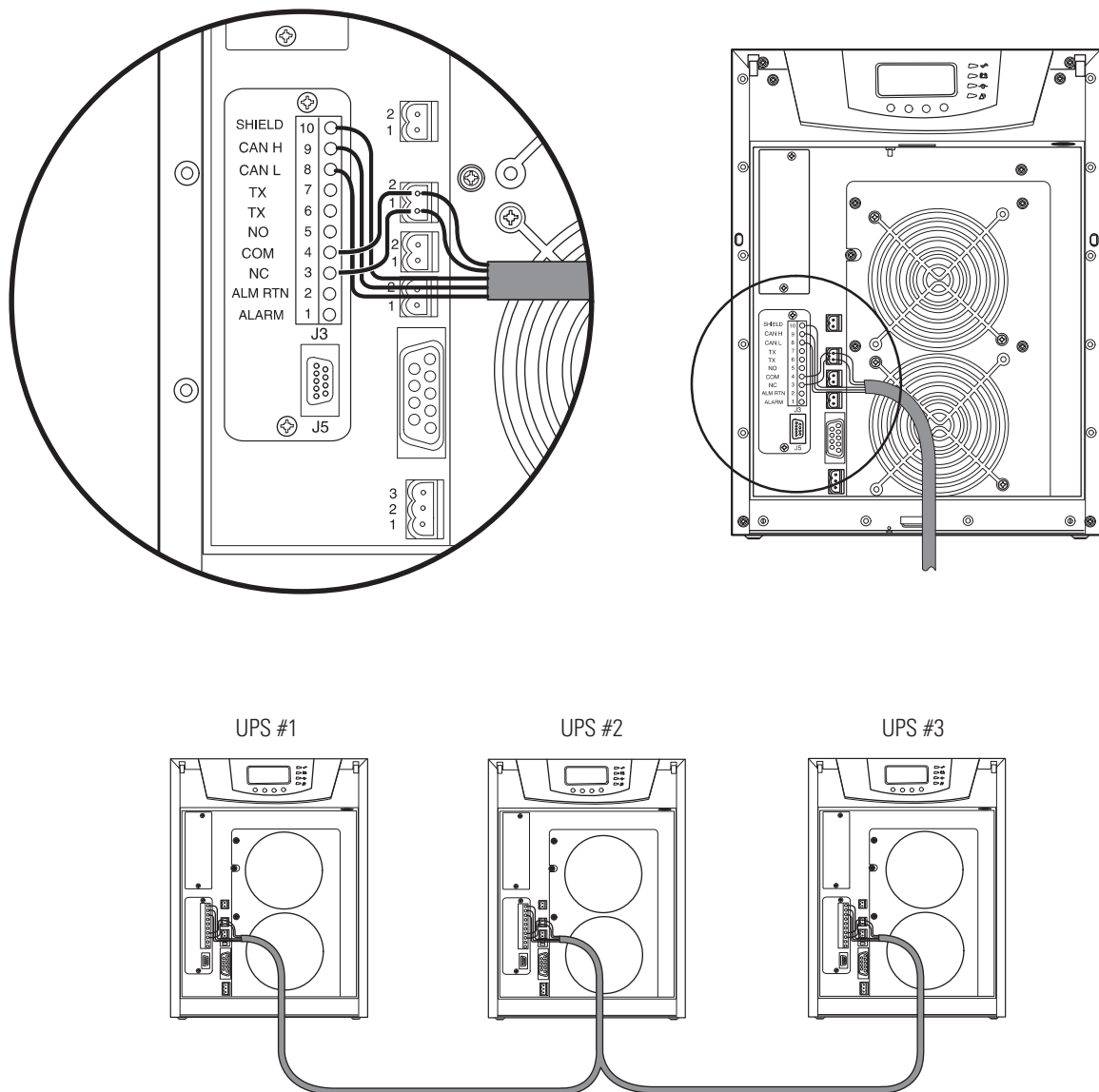

8. Secure the Powerware Hot Sync CAN Bridge Card with the screws removed in [Step 2](#).
9. On the bottom cover (and also the middle cover if 3-high), remove a knockout tab in the top edge of the cover for each cable:
 With wire cutters, cut either side of the tab and twist down to remove the tab (see [Figure 20](#)).

Figure 20. Removing Knockout Tabs

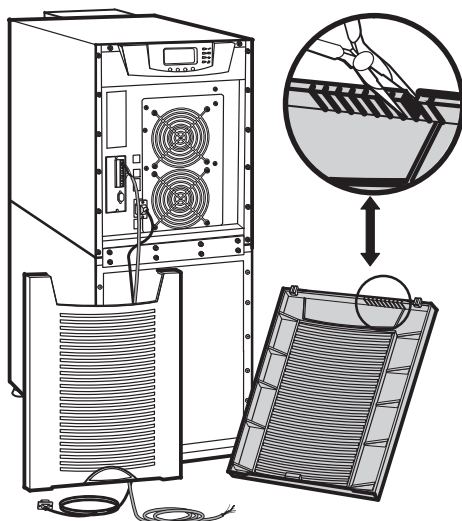

10. Route the cable(s) to the approximate location of the cover access holes.
11. Reinstall the front covers, starting with the bottom cabinet (see [Figure 21](#)).

Hang the top edge of the cover on the cabinet first, then lower the bottom edge and snap into place. Be sure the cables fit in the access holes in the covers.

Figure 21. Reinstalling the Front Covers

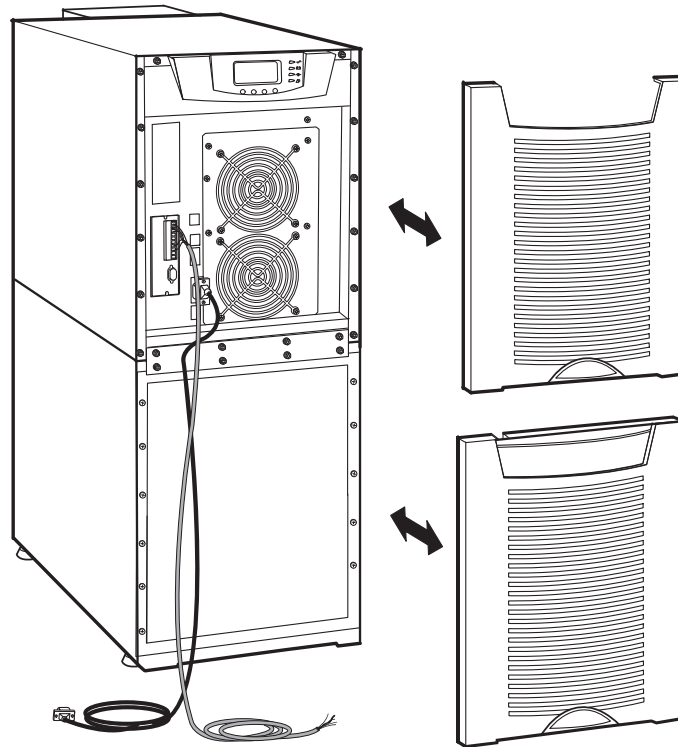

12. Continue to paragraph [4.5 Stabilizing the Cabinet](#) to complete the parallel UPS installation.

4.5 Stabilizing the Cabinet

NOTE 1 For seismic installations, you **MUST** order and install an Eaton 9355 UPS seismic kit; do not use the following instructions.



NOTE 2 For non-seismic installations, you **MUST** install the stabilizing bracket on all 3-high cabinets. The stabilizing bracket is optional for 2-high cabinets.

To stabilize the cabinet(s):

1. Lower the leveling feet to prevent the cabinet from rolling.

Figure 22. Lowering the Leveling Feet

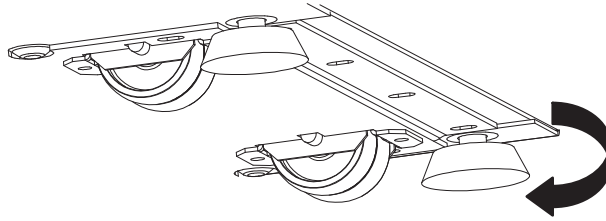

2. Attach the stabilizing bracket to the bottom of the cabinet rear panel using the retained hardware from the shipping pallet according to the cabinet configuration:
 - For one cabinet, see [Figure 23](#).
 - For two cabinets, see [Figure 24](#).
 - For three cabinets, see [Figure 25](#).



NOTE

No more than three cabinets can be attached together. For four cabinets, use two of the two-cabinet installations. For five cabinets, use one three-cabinet and one two-cabinet installation.

3. Use the holes and slots in the bottom of the bracket to attach the cabinet to the flooring if desired.
4. Continue to one of the following sections:
 - See paragraph [4.6 Extended Battery Module Installation](#) to install optional EBMs.
 - See [Chapter 5 UPS Operating Instructions](#) to start up the UPS.

Figure 23. Stabilizing Bracket with One Cabinet

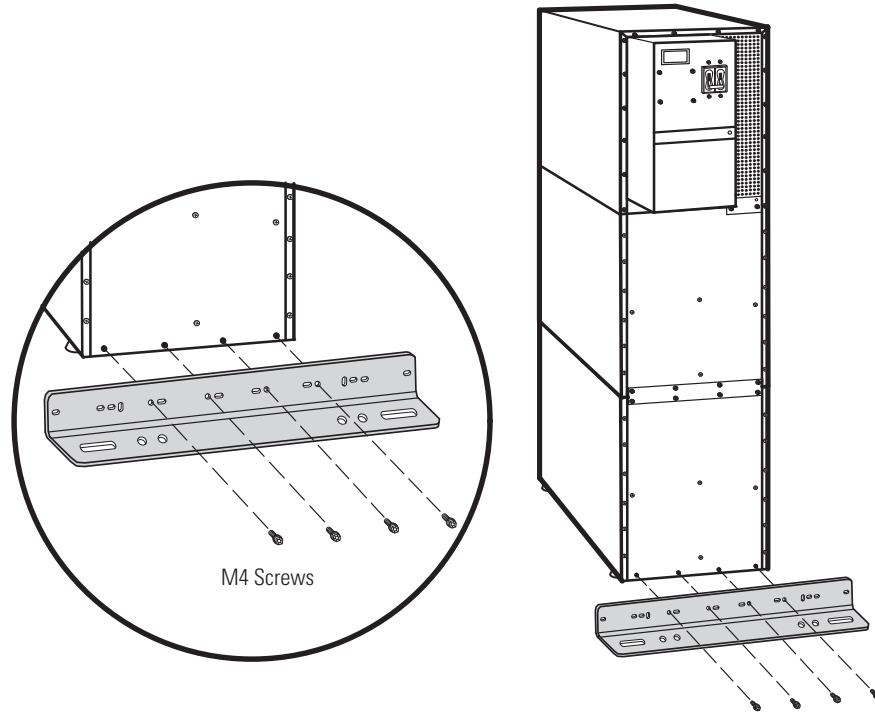

Figure 24. Stabilizing Bracket with Two Cabinets

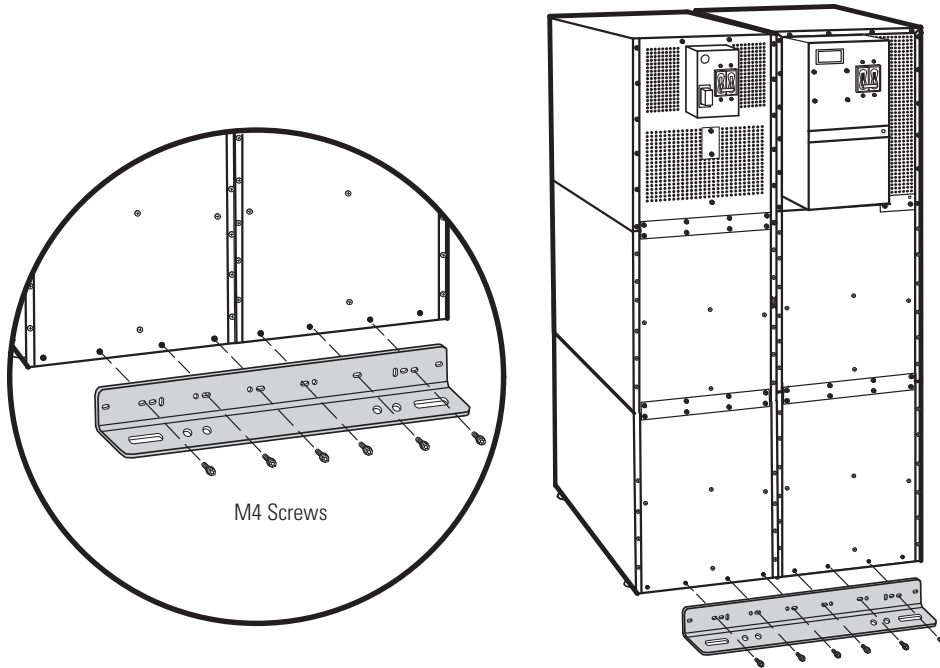
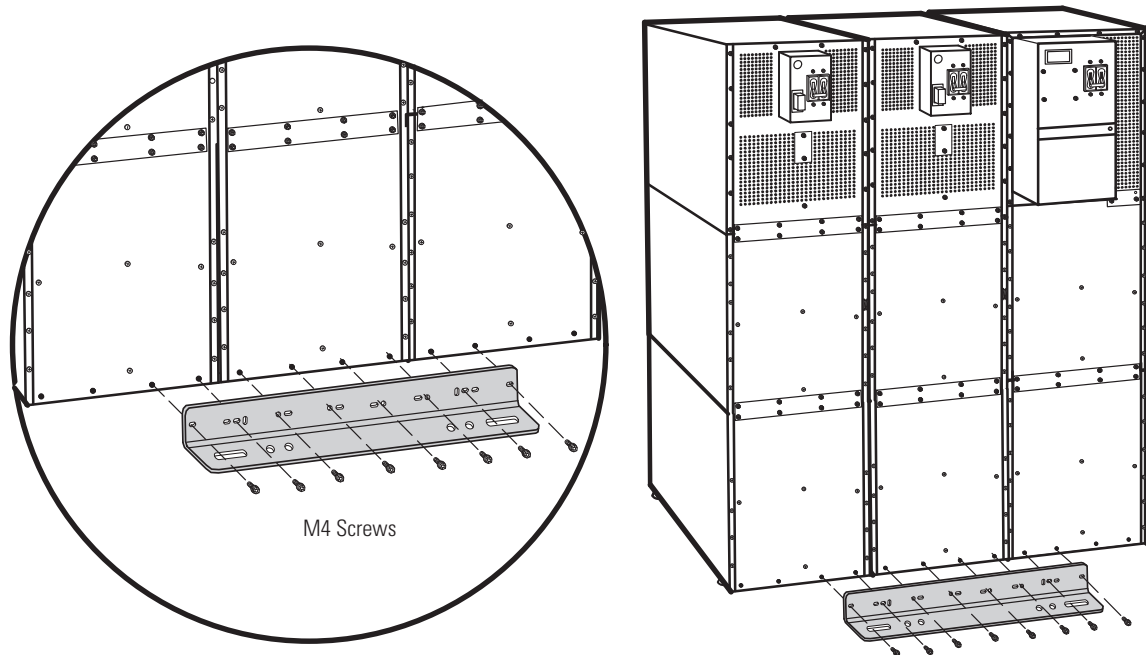

Figure 25. Stabilizing Bracket with Three Cabinets

4.6 Extended Battery Module Installation

NOTE 1 A maximum of 22 battery strings can be installed in one configuration, including UPS batteries (4 EBM-64 models or 3 EBM-96 models). UPS-32 models contain 2 strings; UPS-64 models contain 4 strings; EBM-64 models contain 4 strings; and EBM-96 models contain 6 strings.

NOTE 2 For non-seismic installations, you **MUST** install the stabilizing bracket on all 3-high cabinets. The stabilizing bracket is optional for 2-high cabinets.

NOTE 3 In a parallel system, each UPS should have the same number of Extended Battery Modules (EBMs) to ensure equivalent runtimes.

To install the optional Extended Battery Module (EBM):

1. Position the EBM adjacent to the next cabinet.
2. Verify that all battery circuit breakers are in the OFF position (see [Figure 26](#)).
3. Remove the two ground straps from the EBM rear panel.
4. Install one ground strap between the UPS and EBM rear panels as shown in [Figure 26](#).
5. If additional EBMs are installed, attach another ground strap between the first and second EBM as shown in [Figure 26](#). Repeat for each additional EBM.
6. Plug the EBM cable into the UPS battery connector.

- If additional EBMs are installed, plug the EBM cable of the second cabinet into the battery connector on the first EBM. Repeat for each additional EBM.

Figure 26. Typical EBM Installation (2-High Cabinets Shown)

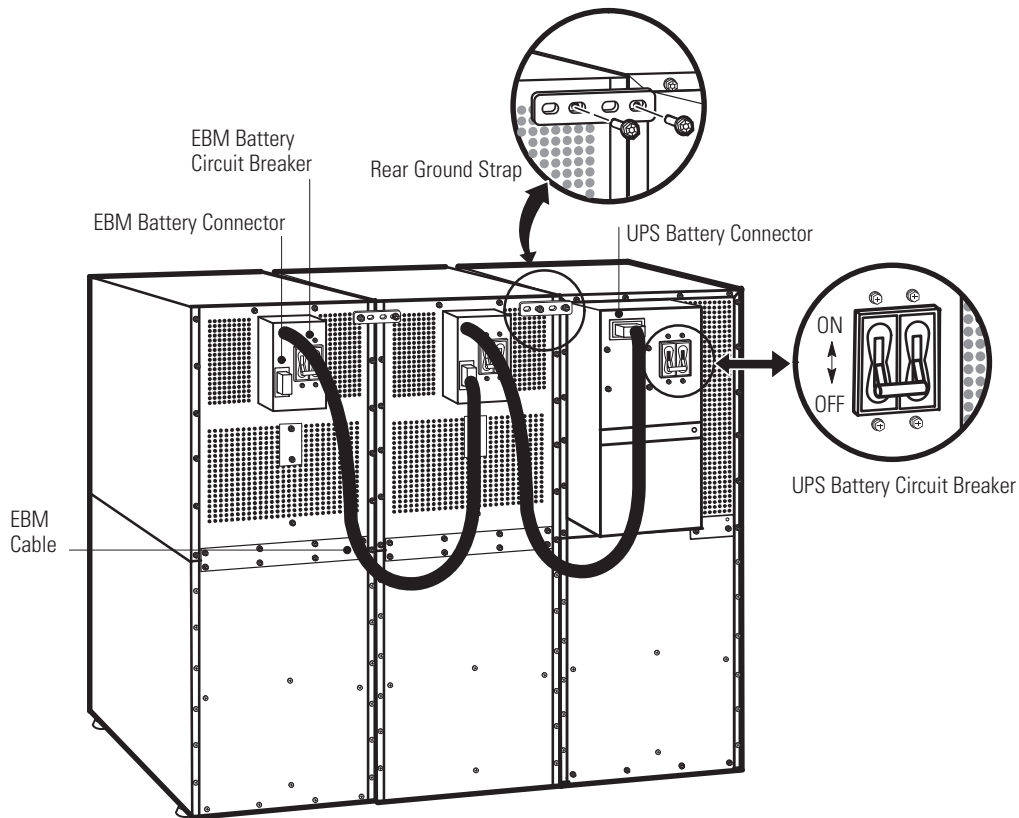

- Remove the top front covers of all cabinets.
Press and release the handle latch at the bottom of the cover and then lift the cover up and off the cabinet.
- Install the remaining ground straps between each cabinet (see [Figure 27](#)).
- Reinstall the top front covers removed in [Step 8](#).
Hang the top edge of the cover on the cabinet first, then lower the bottom edge and snap into place.
- Continue to [Chapter 5 UPS Operating Instructions](#) to start up the UPS.



NOTE

After UPS startup, ensure maximum battery runtime by configuring the UPS for the correct number of EBMs (see paragraph [5.3 Configuring the UPS for EBMs](#)).

Figure 27. Front Ground Strap Installation (2-High Cabinets Shown)

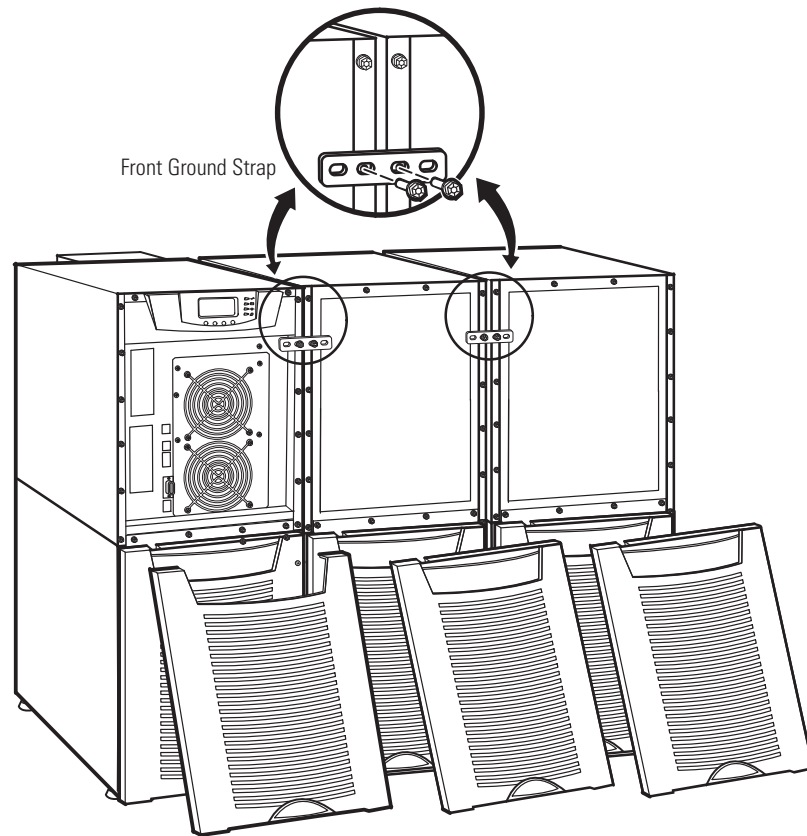

Chapter 5 UPS Operating Instructions

This chapter contains information on how to use the Eaton 9155 UPS, including front panel operation, UPS startup and shutdown, and configuring the UPS for Extended Battery Modules (EBMs).



5.1 Control Panel Functions

The UPS has a four-button graphical LCD with backlight. It provides useful information about the UPS itself, load status, events, measurements, and settings (see [Figure 28](#)).

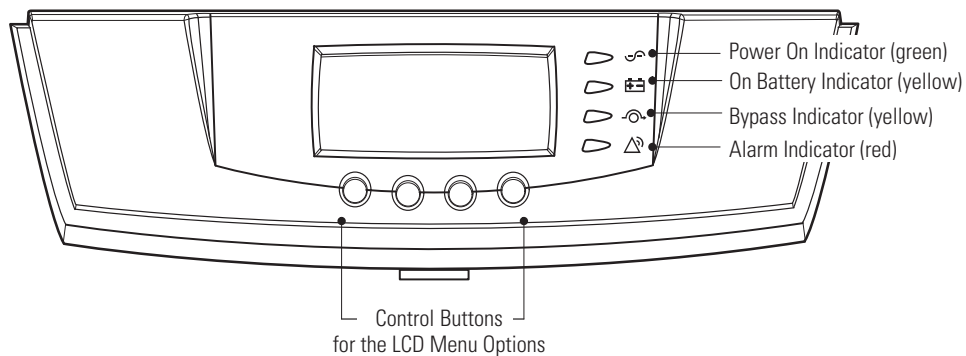
Figure 28. Eaton UPS Control Panel



The following table shows the indicator status and description.

Indicator	Status	Description
 Green	On	The UPS is operating normally.
	Flashing	A new information message is active.
	Off	The UPS is turned off and will not turn on automatically.
 Yellow	On	The UPS is in Battery mode.
 Yellow	On	The UPS is in Bypass mode.

Indicator	Status	Description
 Red	On	The UPS has an active alarm.
	Flashing	There is a new UPS alarm condition. See Chapter 6 Troubleshooting for additional information.





5.1.1 Changing the Language

Press and hold the first button on the left for approximately five seconds to select the language menu. This action is possible from any LCD menu screen.

5.1.2 Display Functions

As the default or after 15 minutes of inactivity, the LCD displays the selectable startup screen. The default is the Eaton logo and can be changed to the Mimic screen in the User Settings menu.

The backlit LCD automatically dims after a long period of inactivity. Press any button to restore the screen.

Use the two middle buttons ( and ) to scroll through the menu structure. Press the  button to enter a submenu. Press the  button to select an option. Press the  button to cancel or return to the previous menu.

The following table shows the basic menu structure.

Table 9. Menu Map for Display Functions

Main Menu	Submenu	Display Information or Menu Function
UPS Status		UPS off / System normal / UPS supporting load / UPS on battery / UPS on bypass / Active alarm list / Battery status
Event Log		Displays up to 127 events and alarms
Measurements	Parallel System	Voltage [by unit] / Voltage [Parallel total] / Output Voltage: L-N / Output Voltage L-L / Output Current / Output Frequency / Output Power
	Output	L-N and L-L / Current / Frequency / Power
	Battery	Voltage / Current / Runtime
	Input	L-N and L-L / Current / Frequency
	Bypass	L-N and L-L / Frequency
Control	Go to Bypass Mode	Transfers the UPS to internal Bypass mode When this command is active, the option changes to Go to Normal Mode.
	Start Battery Test	Initiates a battery test
	Display Test	Four different selectable tests for the front panel functions: the LEDs cycle through, the alarm beep sounds, the backlight turns off and on, and the pixels scroll through to test the LCD.
Settings	User Settings	See Table 10 for detail.
	Service Settings	This screen is password-protected.

Table 9. Menu Map for Display Functions (Continued)

Main Menu	Submenu	Display Information or Menu Function
Identification		UPS Type / Part Number / Serial Number / Firmware / Display / CAN Bridge
Turn UPS ON/OFF	ON and OFF Options	UPS Off / System On / System Off

5.1.3 User Settings

The following table displays the options that can be changed by the user.

NOTE

Changes to the output voltage or frequency options should be made before turning on the UPS; otherwise, the changes do not take effect.

Table 10. User Settings

Description	Available Settings	Default Setting
Set Date and Time	Set Month Date: mm/dd/yyyy Time: 24:00	01/01/2003 00:00
Display Contrast	Adjust contrast with up/down arrow buttons	Moderate
Change Language	Select Language: <English> Elegir idioma <Español>	English
Relay Config	Relay: [Alarm 1] [X-Slot 1-1/2/3/4] or [X-Slot 2-1/2/3/4] Setup: [Battery Low] [On Battery] [On Bypass] [UPS ok] [custom] [empty]	Alarm 1: empty X-Slots (1 or 2) #1: UPS ok #2: On Bypass #3: Summary Alarm #4: On Battery
Signal Inputs	[empty] [Logic] (see Communication Chapter in <i>Eaton 9155 8/15 kVA UPS User's Guide</i> .)	<empty>
Serial Port Config	Port: [X-Slot-1] [X-Slot-2/Serv] Speed: [19200] [9600] [2400] [1200]	19200
Modem Config	Modem Installation	<Not Installed>
	Set Modem Call Events	Event #0 Call modem: no
	Set Modem Init String	ATZ0
	Set Modem Call Command	None
	Set Modem Communication Password	None
Start Screen	Eaton logo Mimic screen	Eaton logo
User Password	Enabled/Disabled If Enabled is selected, the password is USER.	Disabled

Table 10. User Settings (Continued)

Description	Available Settings	Default Setting
Audible Alarms	Normal Sound/Disabled	Normal Sound
Battery Charging	ABM cycling/constant	ABM cycling
Automatic Battery Tests	Enabled/Disabled Enabled automatically runs the battery test once a month.	Enabled
Full Power Battery Test	Enabled/Disabled	Enabled
Number of Battery Strings	0 through 22 (see paragraph 5.3 Configuring the UPS for EBMs for more information.)	2 strings for UPS-32 models 4 strings for UPS-64 models
Battery Capacity	1 through 65535 watts per cell	34 W/cell
Battery Low Alarm Level	1.750 through 1.950 volts per cell	1.880 V/cell
Set Nominal Output Voltage	Output: [120V/208V] [127V/220V]	120V/208V
Bypass Voltage High Limit	+1 through +20% (1% increments)	120V +10%
Bypass Voltage Low Limit	-1 through -20% (1% increments)	120V -15%
Nominal Output Frequency	50 Hz or 60 Hz	60 Hz
Synchronization	Enabled/Disabled	Enabled
Synchronization Window	±0.5 through ±3.0 Hz (0.1 Hz increments)	±2.0 Hz
Unsynchronized Transfer to Bypass	Allowed/Not Allowed	Not Allowed
Output Frequency Slew Rate	0.1 though 5 hertz per second (0.1 Hz increments)	0.5 Hz/s
Usage of Bypass	Enabled/Disabled	Enabled
Transfer to Bypass When Overload	After a delay/Immediately	After a delay
Automatic Start Delay	-1 through 32767 seconds (-1 means disabled)	0s
Control Commands from X-Slot1	Allowed/Disabled	Allowed
Control Commands from X-Slot2/Serv	Allowed/Disabled	Allowed
X-Slot Signal Input Activation Delay	0 through 65 seconds	5s
Input signal delayed shutdown delay	1 through 65535 seconds	120s
Site Wiring Fault Notice	Enabled/Disabled	Enabled
Reset Custom Event Settings	0 through 32	Total: 0/32
Auto Output Configuration	Enabled/Disabled	Enabled for initial startup Disabled after initial startup

5.2 Parallel UPS Startup

WARNING

Only qualified service personnel (such as a licensed electrician) should perform the UPS installation. Initial startup must be performed by an authorized Eaton Customer Service Engineer. Risk of electrical shock.

Verify that UPS installation has been carried out correctly and the UPS ground has been connected.



NOTE

In a parallel capacity system (2+0 or 2+1), determine the minimum number of UPSs required for capacity.







To start up the parallel system (Initial Startup or from complete System power off):

1. Verify that all UPS breakers on the parallel tie cabinet are in the OFF position.
2. Switch ON the utility power where the UPSs are connected.
3. Wait for the front panel LCD to illuminate.

The  indicator flashes on each UPS.

4. Verify fans have started.
5. Switch all battery circuit breakers to the ON position.

The  indicator stops flashing on each UPS.

6. Configure the UPS for parallel operation through the front panel:
 - Press any button on the front panel display to activate the menu options.
 - Using the  button, scroll to the Settings menu, and then press the  button twice to select the User Settings menu.
 - Use the  button to scroll to the Parallel Operation Mode option and press the  button to enter the menu.
 - Use the  button to scroll the desired option (either Redundant Mode or Capacity Mode).
 - Press the  button to save the setting.
7. Press the  button until the Eaton logo or Mimic screen appears.
8. Repeat Steps 6 and 7 for the remaining UPSs in the parallel system.
9. Shut down each UPS:
 - Switch the UPS battery circuit breaker to the OFF position.
The UPS is disconnected from the batteries and is on logic power only.
10. Cycle the utility power to the distribution point where the parallel tie cabinet and UPSs are connected. Wait until the LCD is off before reapplying utility power.
11. Switch the UPS breakers on the parallel tie cabinet to the ON position.
12. Switch all battery circuit breakers to the ON position.



- Verify that no alarms appear on the UPS front panel display.

If the  indicator is flashing, do not proceed until all alarms are clear. Check the UPS status from the front panel to view the active alarms. Correct the alarms and restart if necessary.

- Verify the phase rotation for each UPS.
- From the UPS Status menu, select the Units on CAN Bus option and verify that all UPSs appear in the list.

If all UPSs appear in the list, press the  button until the Eaton logo or Mimic screen appears.

If any UPS is missing, verify the Powerware Hot Sync CAN Bridge Card connections and recheck the status from the UPS front panel.

- Press the  button on the front panel display and then press the  button to select the TURN UPS ON/OFF menu.
- Select the System On option; press and hold the  button for three seconds, until the UPS stops beeping.







The UPS goes to Bypass mode for five seconds, and then the  indicator illuminates. Each UPS should be in Normal mode.

- Press the  button until the Eaton logo or Mimic screen appears.

5.3 Configuring the UPS for EBM

 **NOTE** Each UPS in a parallel system must have its own EBM and the same number of EBMs to ensure consistent runtimes.

To ensure maximum battery runtime, configure the UPS for the correct number of EBMs:



- Press any button on the front panel display to activate the menu options.
- Using the  button, scroll to the Settings menu.
- Press the  button twice to select the User Settings menu.
- Using the  button, scroll to the Battery Setup option and press the  button.
- Use the  or  buttons to select the number of strings according to your UPS configuration:

All 2-High UPS and EBM Cabinets*	Number of Strings
UPS + 1 EBM	6
UPS + 2 EBMs	10
UPS + 3 EBMs	14
UPS + 4 EBMs	18
All 3-High UPS and EBM Cabinets*	Number of Strings
UPS + 1 EBM	10
UPS + 2 EBMs	16

 UPS + 3 EBMs





22

 * UPS-32 models contain 2 strings; EBM-64 models contain 4 strings.
 UPS-64 models contain 4 strings; EBM-96 models contain 6 strings.

6. Press the  button to save the setting.
7. Press the  button until the Eaton logo appears.





5.4 Parallel System Shutdown

To remove power to the parallel UPS system output:

1. Press any button on the front panel display to activate the menu options.
2. Press the  button on the front panel display and then press the  button to select the TURN UPS ON/OFF menu.
3. Press the  button to select the System Off option; press and hold the  button for three seconds, until the UPS stops beeping.
4. Repeat Step 3.
The input contactor opens.
The UPS removes power to the parallel UPS system output.
5. Press the  button until the Eaton logo or Mimic screen appears.
6. Repeat Steps 1 through Step 5 for each UPS in the Parallel System.
7. Switch each of the UPS breakers on the parallel tie cabinet to the OFF position.
8. Switch all battery circuit breakers to the OFF position.
9. Switch OFF the utility power to the Parallel UPS system.

5.5 Individual UPS Shutdown

To shut down a single UPS in the parallel system:

1. Press any button on the front panel display to activate the menu options.
2. Press the  button on the front panel display and then press the  button to select the TURN UPS ON/OFF menu.
3. Press the  button to select the System Off option; press and hold the  button for three seconds, until the UPS stops beeping.
4. Repeat Step 3.
The input contactor opens.
5. Switch the UPS battery circuit breaker to the OFF position.
The UPS is disconnected from the batteries and is on logic power only.
6. Switch the UPS breaker on the parallel tie cabinet to the OFF position.

 **NOTE** If there is only one breaker for all UPSs, do not switch off utility power until all UPSs are shut down.

7. Switch OFF the utility power where the UPS is connected.

 **NOTE** If you are shutting down all the UPSs in a parallel system, repeat Steps 2 through 6 for each UPS then remove utility power.

5.6 Restarting the Parallel System

To restart the parallel system:

1. Verify that all UPS breakers on the parallel tie cabinet are in the OFF position.
2. Switch ON the utility power where the UPSs are connected.
3. Wait for the front panel LCD to illuminate.





The  indicator flashes on each UPS.

4. Switch all battery circuit breakers to the ON position.

The  indicator stops flashing on each UPS.

5. Switch the UPS breakers on the parallel tie cabinet to the ON position.
6. Verify that no alarms appear on the UPS front panel display.

If the  indicator is flashing, do not proceed until all alarms are clear. Check the UPS status from the front panel to view the active alarms. Correct the alarms and restart if necessary.



7. Press the  button once and then press the  button to select the TURN UPS ON/OFF menu.
8. Press the  button to select the System On option; press and hold the  button for three seconds, until the UPS stops beeping.



The UPS goes to Bypass mode for five seconds, and then the  indicator illuminates. Each UPS should be in Normal mode.

9. Press the  button until the Eaton logo or Mimic screens appears.

5.7 Parallel UPS Bypass Operation

To switch the parallel UPS from Normal mode to maintenance bypass :

1. From any UPS, set the system to internal Bypass mode:
 - Using the  button on the front panel display, scroll to the Control menu option and press the  button.
 - Press the  button to select the Go to Bypass Mode option.

The  and  indicators illuminate, indicating the UPS system is operating in Bypass mode.

2. Switch the bypass breaker on the parallel tie cabinet to the ON position.
3. Switch the UPS breakers on the parallel tie cabinet to the OFF position.

To return to Normal Mode from maintenance bypass:

1. Verify that all UPS breakers on the parallel tie cabinet are in the OFF position.
2. Switch on utility power where the UPSs are connected.



In a parallel capacity system (2+0 or 2+1), apply utility to the minimum number of UPSs required for capacity.





NOTE

Use the same UPS that was used to set internal bypass to return the parallel system to Normal mode.

3. Set the system to internal Bypass mode:

- Using the  button on the front panel display, scroll to the Control menu option and press the  button.
- Press the  button to select the Go to Bypass Mode option.

The  and  indicators illuminate, indicating the UPS system is operating in Bypass mode.





4. Switch all UPS breakers on the parallel tie cabinet to the ON position.
5. Switch the bypass breaker on the parallel tie cabinet to the OFF position.
6. On the same UPS front panel, set the UPS to Normal mode:
 - Press the  button to select the Go to Normal Mode option.
 - Each UPS should go to Normal mode..





Chapter 6 Troubleshooting

The Eaton 9155 UPS is designed for durable, automatic operation and also alerts you whenever potential operating problems may occur. Usually the alarms shown by the control panel do not mean that the output power is affected. Instead, they are preventive alarms intended to alert the user. Use the following troubleshooting chart to determine the UPS alarm condition.

6.1 Typical Alarms and Conditions

The following table describes typical alarms and conditions; check the Event Log through the control panel for a list of active alarms. If an alarm appears with a service code, please contact the Help Desk (see page [6.3 Service and Support](#)).

Alarm or Condition	Possible Cause	Action
On Battery  LED is on. 1 beep every second.	A utility failure has occurred and the UPS is in Battery mode.	The UPS is powering the equipment with battery power. Prepare your equipment for shutdown.
Battery Low  LED is on. Continuous beep for 10 seconds.	The battery is running low.	Five minutes or less of battery power remains (depending on load configuration and battery charge). Save your work and turn off your equipment. When utility power is restored, the UPS restarts automatically, provides power to the load, and charges the battery.
Battery Breaker  LED is on. 1 beep every second.	The UPS does not recognize the internal batteries.	Verify the battery circuit breaker is in the ON position. If the condition persists, contact your service representative.
Overload  LED is on. 1 beep every second.	Power requirements exceed the UPS capacity (greater than 100% of nominal; see page for specific output overload ranges).	Remove some of the equipment from the UPS. The UPS continues to operate, but may switch to Bypass mode if the load increases. The alarm resets when the condition becomes inactive.
Overtemperature  LED is on. 1 beep every second.	UPS internal temperature is too high or the fan has failed.	Turn the maintenance bypass switch to the SERVICE position. Otherwise, shut down the UPS. Clear vents and remove any heat sources. Allow the UPS to cool. Ensure the airflow around the UPS is not restricted. If the alarm disappears, turn the maintenance bypass switch back to the UPS position. If the condition persists, contact your service representative.
Battery test failed	The batteries need service.	Contact your service representative.
The UPS does not start.	The main utility breaker is off.	Verify that the main utility breaker is on.
	If an optional isolation transformer is installed, the input circuit breaker is off.	Verify that the isolation transformer input circuit breaker is on.

Alarm or Condition	Possible Cause	Action
	The remote emergency power-off (REPO) switch is active or the REPO connector is missing.	Reset the REPO switch and restart the UPS. Verify that the REPO connector is present.
Power is not available at the UPS output receptacles.	The UPS is in Standby mode.	Supply power to the connected equipment: Press any button on the front panel display to activate the menu options. Press the  button on the front panel display and then press the  button to select the TURN UPS ON/OFF menu. Press the  button to select the TURN UPS ON option; press the  button. Press and hold the  button for three seconds, until the UPS stops beeping.
The UPS does not provide the expected backup time.	The batteries need charging or service.	Apply utility power for 48 hours to charge the batteries. If the condition persists, contact your service representative.
	Battery circuit breakers are in the OFF position.	Switch all battery circuit breakers to the ON position.
Check Parallel Board	The UPS is not recognizing another parallel unit.	From the UPS Status menu, select the Units on CAN Bus option and verify that all UPSs appear in the list. If any UPS is missing, verify the Powerware Hot Sync CAN Bridge Card connections and recheck the status from the UPS front panel. If all UPSs appear in the list, check the pull-chain wiring (see page 26). Set the system to internal Bypass mode (see page 53). If the condition persists, contact your service representative.
Abnormal output voltage at startup	The UPS breaker on the parallel tie cabinet was not switched to the ON position properly.	Shut down the UPS where the alarm is indicated. Switch the UPS breaker on the parallel tie cabinet to the ON position. Start up the UPS. Select the System On option through the front panel of the UPS that was turned off.
Selective Trip	The Powerware Hot Sync CAN Bridge Card is not wired correctly.	Verify the CAN wiring (see page 26). Verify the pull-chain wiring (see page 26). If the condition persists, contact your service representative.

6.2 Silencing the Alarm

Before silencing an alarm, check the alarm condition and perform the applicable action to resolve the condition.

Press any button on the front panel display to silence the alarm. If the alarm status changes, the alarm beeps again, overriding the previous alarm silencing.

6.3 Service and Support

If you have any questions or problems with the UPS, call your **Local Distributor** or the **Eaton Customer Support Center** at one of the following telephone numbers.

Available support services:

- Onsite service technician scheduling
- Technical product information or troubleshooting
- RMA or parts request processing
- Purchase of replacement batteries or service contracts

United States: **1-800-843-9433 or 1-919-871-1800**

Canada: **1-800-461-9166 ext 260**

All other countries: **Call your local service representative**

Please have the following information ready when you call for service:

- Model number
- Serial number
- Firmware version number
- Date of failure or problem
- Symptoms of failure or problem
- Customer return address and contact information

Chapter 7 Warranty

For warranty information, please refer to the Resources link on our website, www.eaton.com/9155.

EQUIPMENT REGISTRATION

Please visit www.eaton.com/pg/register to register your new Eaton UPS / Eaton UPS Accessory.

Model Number:

Serial Number:



164201592 E0