



Eaton 3SMini

3SM36
3SM36B

Advanced User Guide



Copyright © 2021 EATON
All rights reserved.
AUG_EATON-3SMINI_V0
3SMini EMEA

Special symbols

The following are examples of symbols used on the UPS or accessories to alert you to important information:



DANGEROUS VOLTAGE - Observe the warning associated with the risk of electric shock symbol.



Important instructions that must always be followed.



Information, advice, help.



Read the documentation provided.



This equipment should only be used in a dry indoor environment.



+35 °C
0 °C

Operating range of temperature.



85%
10%

Operating range of humidity.



The UPS and their batteries must be kept in a ventilated place.

1. Table of contents

1. Table of contents	3
2. Introduction	4
3. Presentation	5
4. Installation	6
4.1. Package contents	6
4.2. Safety	7
4.3. Power supply cord / socket	8
4.4. Start UPS	9
4.5. Voltage setup	10
4.6. Connect the equipment	12
5. Other functions	13
5.1. Turn OFF, turn ON	13
5.2. Display battery level	13
6. Troubleshooting	14
7. Technical specifications	16
8. Equipment care	17
9. Service and support	17

2. Introduction

Thank you for selecting an Eaton product to protect your equipment.

The Eaton 3SMini range has been designed with the utmost care. We recommend that you take the time to read this advanced user guide and documentations provided to take full advantage of the many features of your UPS (Uninterruptible Power System).

Before installing your Eaton 3SMini, please read the information and safety instructions provided. Follow the instructions in the quick start guide and if necessary, refer to this advance user guide.

To discover the entire range of Eaton products, we invite you to visit our web site at eaton.com or contact your Eaton representative.

The Eaton 3SMini Uninterruptible Power System (UPS) is designed for small electrical such as, but not limited to, Internet gateways, switches or routers, IP cameras etc. It must not be used to supply other electrical equipment (lighting, household appliances, etc.). It prevents your critical equipment from power failures and power surges.

3. Presentation

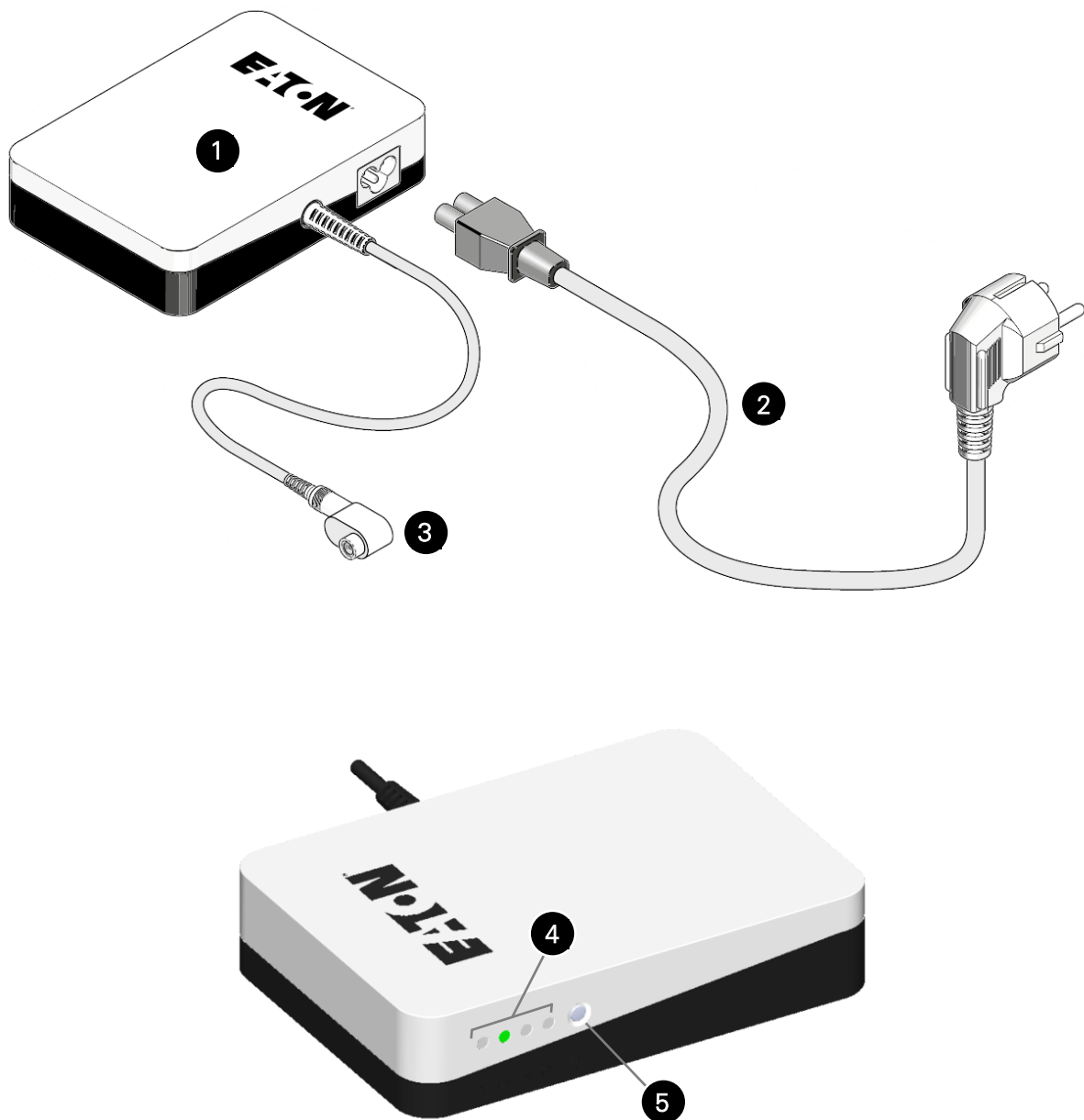





- ❶ Mini UPS (plastic casing)
- ❷ Removable AC input cord (CEE7/7 FR/DIN shown here)
- ❸ Attached DC output cord
- ❹ 4x green LED: Voltage (Chapter 4.5), battery level (Chapter 5.2) and abnormal situations (Chapter 6)
- ❺ ON/OFF button, battery level display and voltage selector

4. Installation

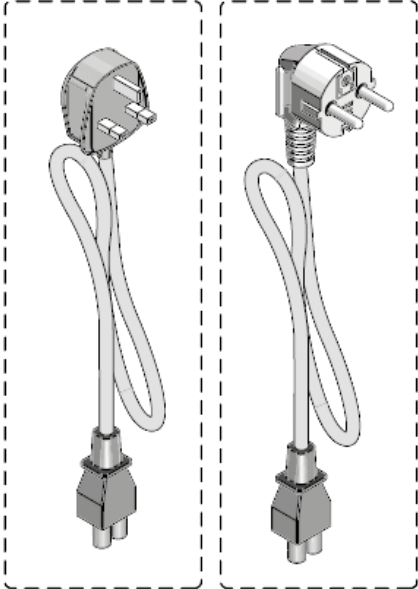
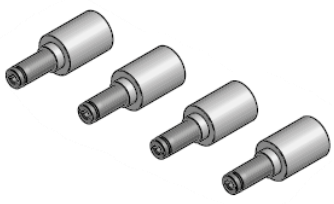
4.1. Package contents

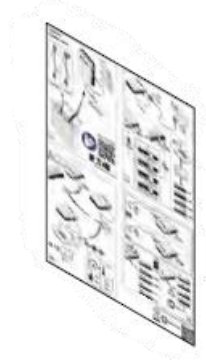
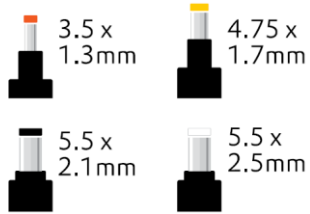
Included with the Eaton 36W AC-to-DC UPS:

 <p>3SM36B 3SM36</p>	 <p>Barrel adaptor polarity:</p> 	
<p>Supplied input cord (x1):</p>	<p>Supplied barrel connectors (x4):</p>	<p>Supplied Quick start/Safety notes (x1):</p>
<p>BS1363: 3SM36B models</p> <p>or</p> <p>CEE7/7 (FR/DIN): 3SM36 models</p>	<p>BARREL ADAPTORS INCLUDED:</p>  <p><u>Note:</u> Extended replacement kit can be ordered through your local customer service</p>	 <p>eaton.eu/3SMini</p>

4.2. Safety

For product installation or additional information refer to the Quick Start and Advanced User Guide. For customer support please contact your local after sales services.



DANGER: Dangerous voltage levels are present within the UPS. Do not attempt to open the unit.



CAUTION: Do not dispose of batteries in a fire. When exposed to flame, batteries may explode. Do not open or mutilate the battery or batteries. Released electrolyte is harmful to the skin and eyes and may be extremely toxic.

Installation



Check that the indications on the rating plate correspond to your AC-power system and to the actual electrical consumption of all the equipment to be connected to the UPS. For PLUGGABLE EQUIPMENT, the socket-outlet shall be installed near the equipment and shall be easily accessible. Ensure that AC main outlet is properly earthed.

The UPS and their batteries must be kept in a ventilated place. Never expose the UPS to direct sunlight or source of heat. This equipment should only be used in a dry indoor environment. The admissible storage conditions are -20°C to +45°C (around 3 Months) and +25°C max (1 year+). 0% to 95% of humidity non-condensing.

Do not place the UPS on any heat source or electronic equipment.

Use and Maintenance



There are no user serviceable parts inside the UPS.

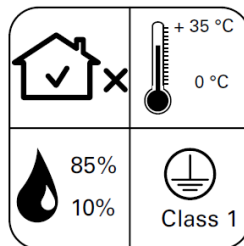

Environmental Notice



Eaton has implemented an environmental-protection policy. Our products are developed according to an eco-design approach ([eaton.com/productstewardship](https://www.eaton.com/productstewardship)).



Battery: The product contains batteries that must be processed according to applicable local regulations concerning batteries.



The product includes Li-ion batteries, follow end-of-life instruction in view of correct waste disposal

4.3. Power supply cord / socket

Connect the UPS to the AC power source through a wall-protected outlet equipped with an earth connector, using the attached cord for a UPS with FR/DIN (CEE7/7) or British (BS1363) sockets.

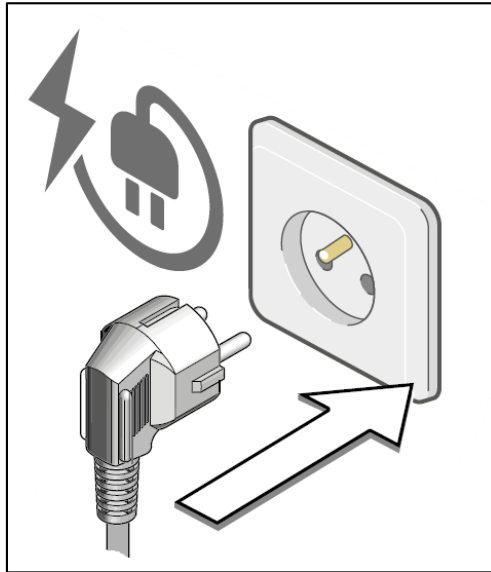

Figure 1 FR/DIN example



Initial power-on requires that the UPS is plugged to main first.

4.4. Start UPS



Do not connect load until the voltage has been appropriately setup (see 4.5)
Press the ON/OFF button for **three** seconds. The battery level is first displayed for **five** seconds then the LED indicates the output voltage level (**default 12V**):



Figure 2 Start UPS

Battery levels:

	Slow blinking LED
	Fast blinking LED

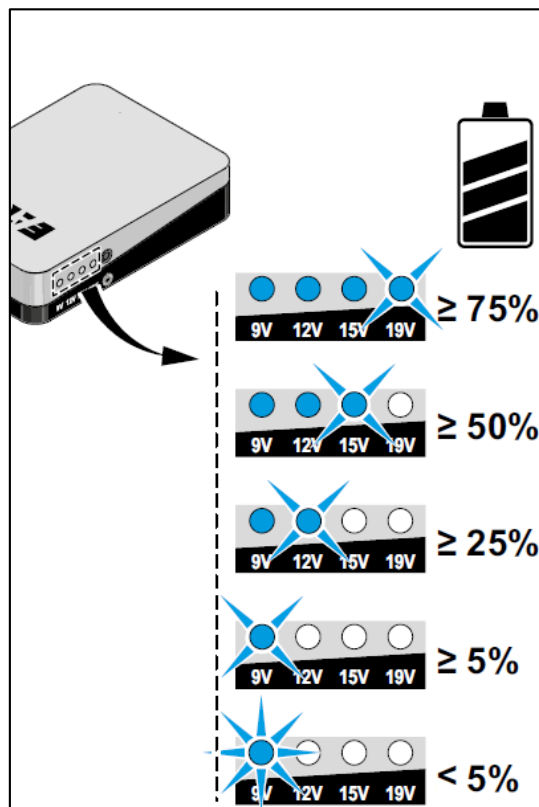

Figure 3 Battery levels

4.5. Voltage setup



Before entering voltage setup, ensure that the protected equipment is disconnected from the UPS:

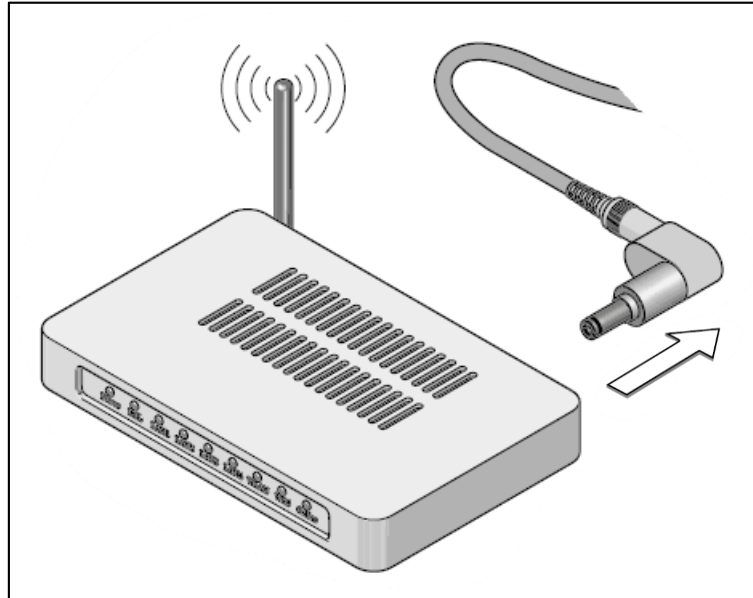

Figure 4 Disconnect the equipment

Then enter voltage setup mode and select the appropriate output DC voltage corresponding to equipment nominal input voltage (9V, 12, 15V or 19V):

- Press the ON/OFF button (5) for **eight** seconds



Important: The LED and UPS will **briefly** shutdown (OFF to 0V) during the process and it will turn off any connected equipment, just keep pressing the button until **eight** seconds have passed. When LED start flashing (slow), release the button.

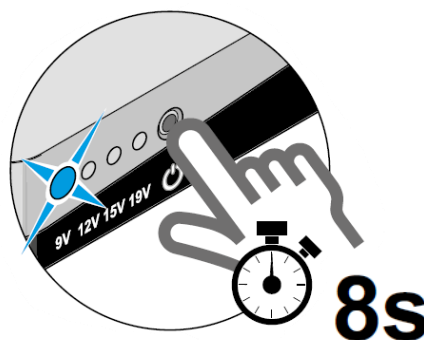

- You can then cycle through the different LED position which indicate the voltage output by pressing the ON/OFF button (quick press). Note that the voltage is not active until the selection is confirmed.

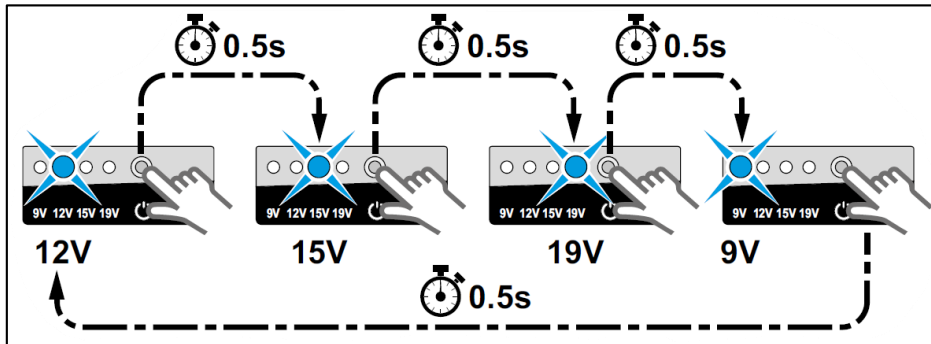
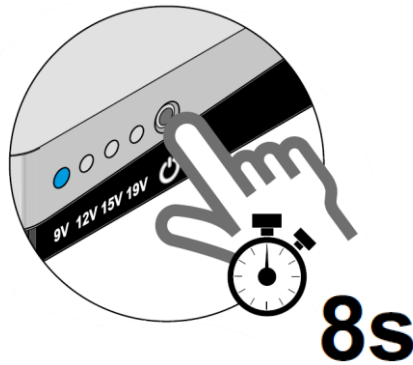

Figure 5 Cycle through the voltage levels

- Once the voltage is selected, then simply press **eight** seconds to confirm the choice. The LED will stop blinking and steady itself. The DC output is now delivering the new voltage.



4.6. Connect the equipment

- Select the correct barrel adaptor and clip it on the UPS output connector

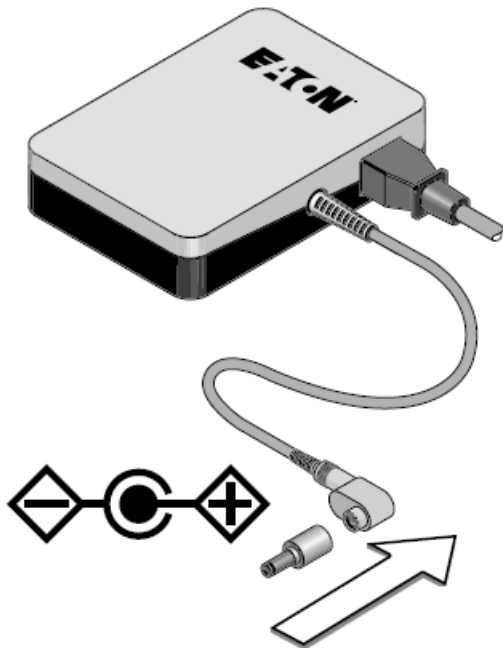

BARREL ADAPTORS INCLUDED:

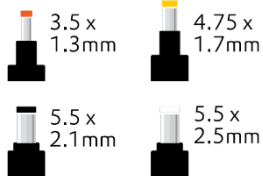

- Plug your equipment

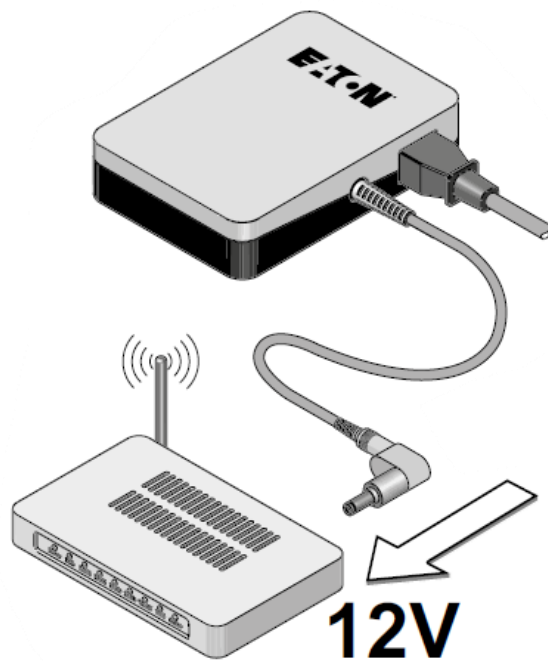

Your equipment is now backed-up



5. Other functions

5.1. Turn OFF, turn ON

Simply press **three** seconds the ON/OFF button (5), ON → OFF or OFF → ON

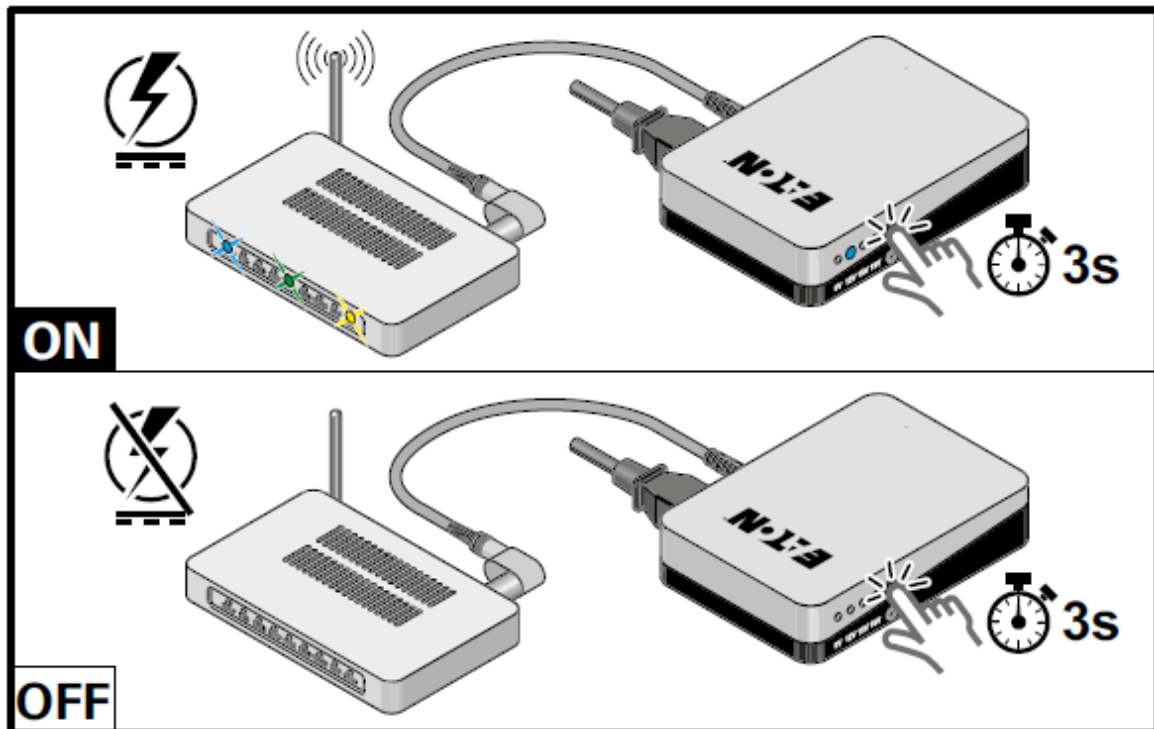

Figure 6 Turn ON or OFF the UPS



5.2. Display battery level

- The battery level is automatically displayed when the UPS is on battery (no mains)
- On mains, you can simply press the ON/OFF button once (quick press), battery level will be displayed for **five** seconds and return to voltage indication.

6. Troubleshooting

Main LED-indicated abnormal situations:

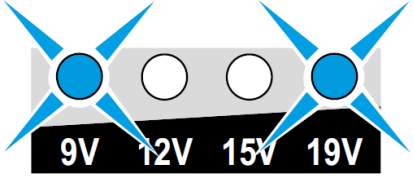
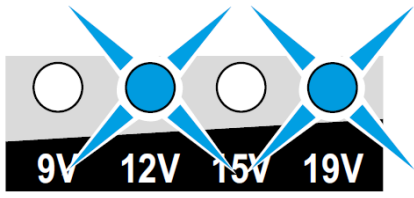
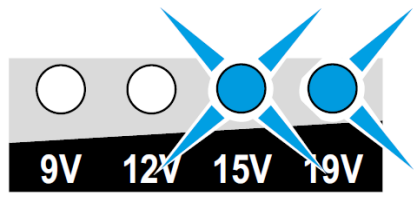
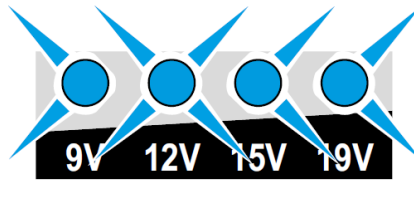
Auto-recovery (AR) mode: when fault condition occurs, UPS will shut down then recover to normal when fault condition is removed.

LED blinking code	Situation description
	<p>Abnormal situation (OCP)</p> <p>Over Current Protection</p> <p>If situation remains the UPS enters AR mode to protect the equipment.</p> <p>UPS automatically returns to normal state once situation is back to normal</p>
	<p>Abnormal situation (OTP)</p> <p>Over Temperature Protection (NTC temperature)</p> <p>If situation remains the UPS enters AR mode to protect the equipment.</p> <p>UPS automatically returns to normal state once situation is back to normal</p>
	<p>Abnormal situation (OVP)</p> <p>Over Voltage Protection</p> <p>If situation remains the UPS enters AR mode to protect the equipment.</p> <p>UPS automatically returns to normal state once situation is back to normal</p>
	<p> Internal failure</p> <p>Keeps blinking for 20 seconds then enters shutdown mode</p> <p>The unit needs replacement. Contact your customer service.</p>

Problem	Possible cause	Action
All LED are OFF	The UPS is turned OFF	Press 3s the ON/OFF button.
UPS does not start	This could be linked to initial state (out-of-box)	Make sure that the UPS is plugged in a wall outlet that delivers power and press three seconds the ON/OFF button. If this does not work, contact your local customer service.
One LED remains OFF when UPS is fully charged, and battery level displayed	LED is defective	Contact your local customer service.
UPS does not charge	Power is not delivered to UPS or batteries may be defective	1) Ensure that charging is not interrupted. 2) Check mains are delivering power. 3) Check that the input cord is well plugged in the UPS. 4) Contact your local customer service.
Load is not powered	UPS is in Auto-Recovery (AR) mode	Unplug the equipment. 1) Verify load electrical characteristics (voltage, power). 2) Let the UPS cool down (keep device away from any heat source). Wait several minutes and try again.
UPS is frozen and ON/OFF button is ineffective	UPS is locked	Disconnect equipment, turn OFF UPS and unplug it from mains. Wait a minute and reconnect UPS. Turn it back ON. Other option: Reset to factory settings: press 15 seconds from the OFF state (unplugged). Then plug UPS and restart UPS.

7. Technical specifications

Technical specifications	
AC Input voltage	100-240V~ AC
AC Input current	CEE7/7 (FR/DIN): 1.6A BS 1363: 1.6A
Input frequency	50/60Hz
Output voltage/Amps	9V/3A 12V/3A 15V/2,4A 19V/1,89A
Output connection Barrel adaptors	5,5 x 2,5 5,5 x 2,1 4,75 x 1,7 3,5 x 1,35
Power rating	36W
Battery type	Li-Ion x2 (ICR18650)* Cell weight: 45g Max
Battery capacity	3,7 V/2200mAh (x2)
UPS dimensions (W x H x D)	95,5 x 30 x 136 mm
UPS weight	0,4 kg
Operating temperature	0 - 35°C
Safety	IEC 62477-1, CE mark, CB report
EMC	IEC 62040-2
Performance	IEC 62040-5-3
Warranty	2 years

* Typical full charge time (may vary): ~4h

Part number	Input cord
3SM36	FR/DIN (1m long)
3SM36BS	BS1363 (1m long)

8. Equipment care

For full battery life, keep the equipment at an ambient temperature of 25 °C (77 °F). Battery service life is reduced as follows;

0<T 10°C, 440mAh
10<T 45°C, 2200mAh
45<T 55°C, 1100mAh



It is recommended to fully charge the battery after initial setup and if possible, to perform **two** or **three** cycles of charge/discharge.



If the UPS requires any type of transportation, verify that the UPS is turned off.

More information on Eaton recycling:



9. Service and support

If you have any question or problem with the UPS, call Eaton or your local service representative in your country / region.

Please have the following information ready when you call for service:

- catalog number,
- serial number,
- date of failure or problem,
- symptoms of failure or problem,
- customer return address and contact information,
- description of the installation.

Register warranty at www.powerquality.eaton.com/EMEA/Product-Registration

===== END =====