

LEFT SIDE VIEW

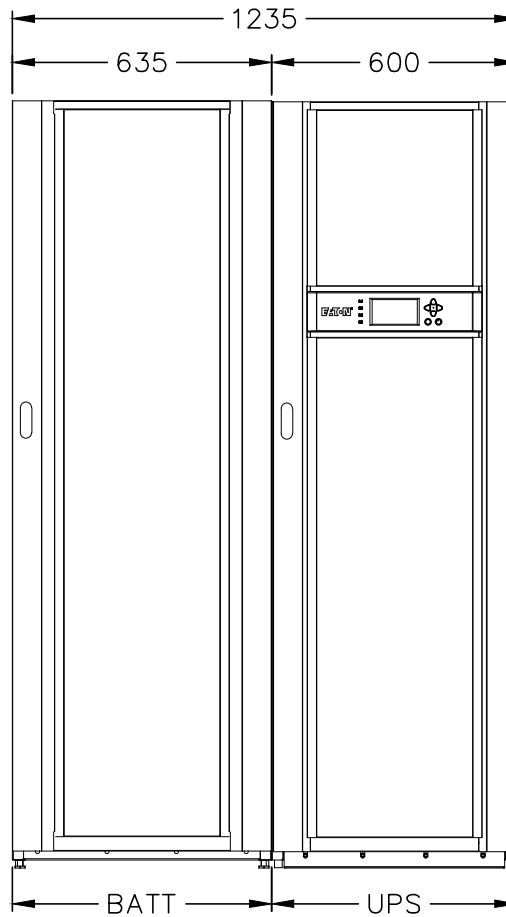

FRONT VIEW

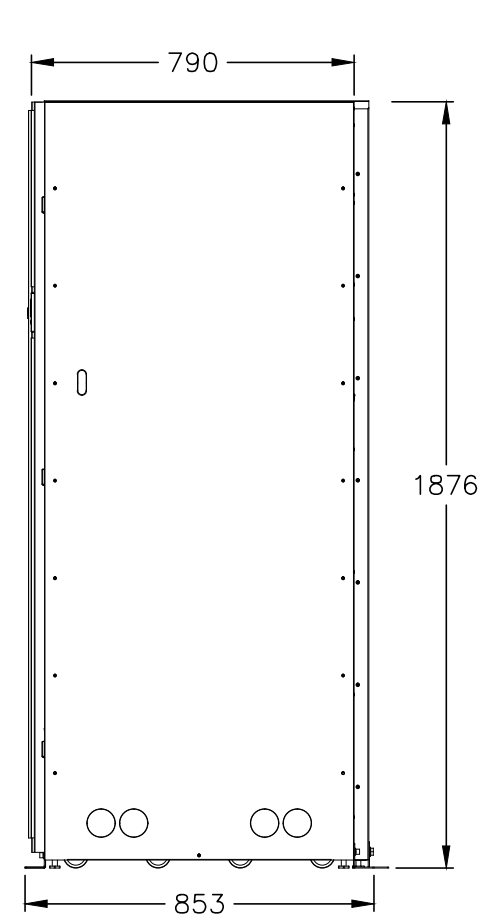

RIGHT SIDE VIEW

BATTERY				
PART NUMBER	93EEBCI150C40XXX	93EEBCI200C40XXX	93EEBCI280C40XXX	93EEBCI320D40XXX
RATING (PER CELL)	150kg	200kg	280kg	320kg
NUMBER OF CELLS	40	40	40	40
MASS	707kg	941kg	1269kg	1317kg

UPS					
PART NUMBER	93E80U-MBS	93E100N-MBS	93E120N-MBS	93E160I-IB	93E200N-IB
RATING	80kVA	100kVA	120kVA	160kVA	200kVA
MASS	283kg	283kg	311kg	457kg	457kg

- NOTES:
- UPS AND BATTERY CABINETS HAVE A BLACK RAL 9005 POWDERCOATED FINISH.
 - MINIMUM CLEARANCES FOR VENTILATION & SERVICE AROUND THE UPS CABINET ARE REQUIRED.

EATON	DRAWN AA	SCALE NTS	FILENAME:	A4
	17.04.14			
	TITLE GENERAL ARRANGEMENT 93E 80-200kW +L-BAT (LEFT)			
DRAWING NUMBER A4GA0017			REV 0	

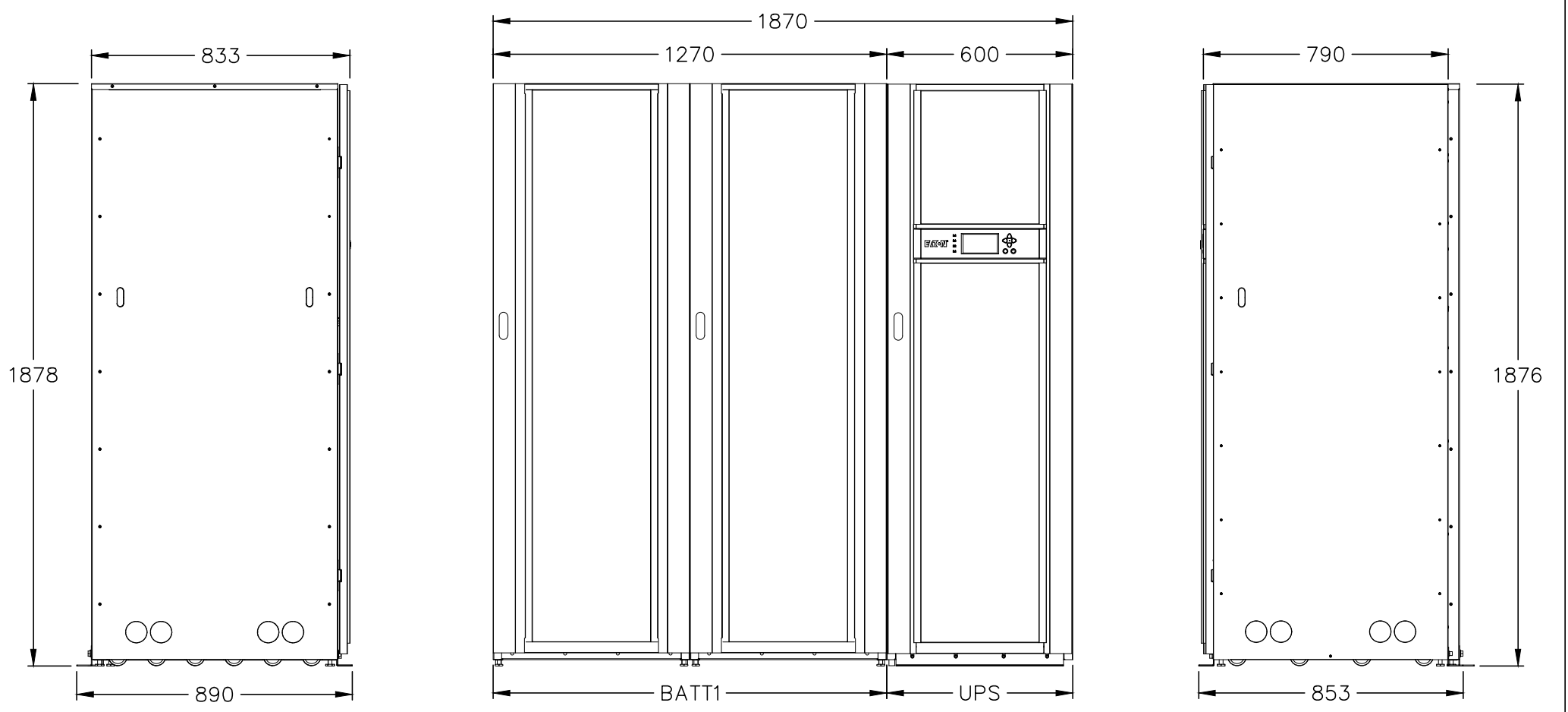

LEFT SIDE VIEW

FRONT VIEW

RIGHT SIDE VIEW

BATTERY			
PART NUMBER	93EEBCII390C40XXX	93EEBCII500C40XXX	93EEBCII620C40XXX
RATING (PER CELL)	390W	500W	620W
NUMBER OF CELLS	40	40	40
MASS	1765kg	2273kg	2333kg

UPS					
PART NUMBER	93E80U-MBS	93E100N-MBS	93E120N-MBS	93E160I-IB	93E200N-IB
RATING	80kVA	100kVA	120kVA	160kVA	200kVA
MASS	283kg	283kg	311kg	457kg	457kg

- NOTES:**
- UPS AND BATTERY CABINETS HAVE A BLACK RAL 9005 POWDERCOATED FINISH.
 - MINIMUM CLEARANCES FOR VENTILATION & SERVICE AROUND THE UPS CABINET ARE REQUIRED.

	<small>DRAWN</small> AA 17.04.14	<small>SCALE</small> NTS	<small>FILENAME:</small>	A4
	<small>TITLE</small> GENERAL ARRANGEMENT 93E 80-200kW +LL-BAT (LEFT)			
	<small>DRAWING NUMBER</small> A4GA0018			<small>REV</small> 0

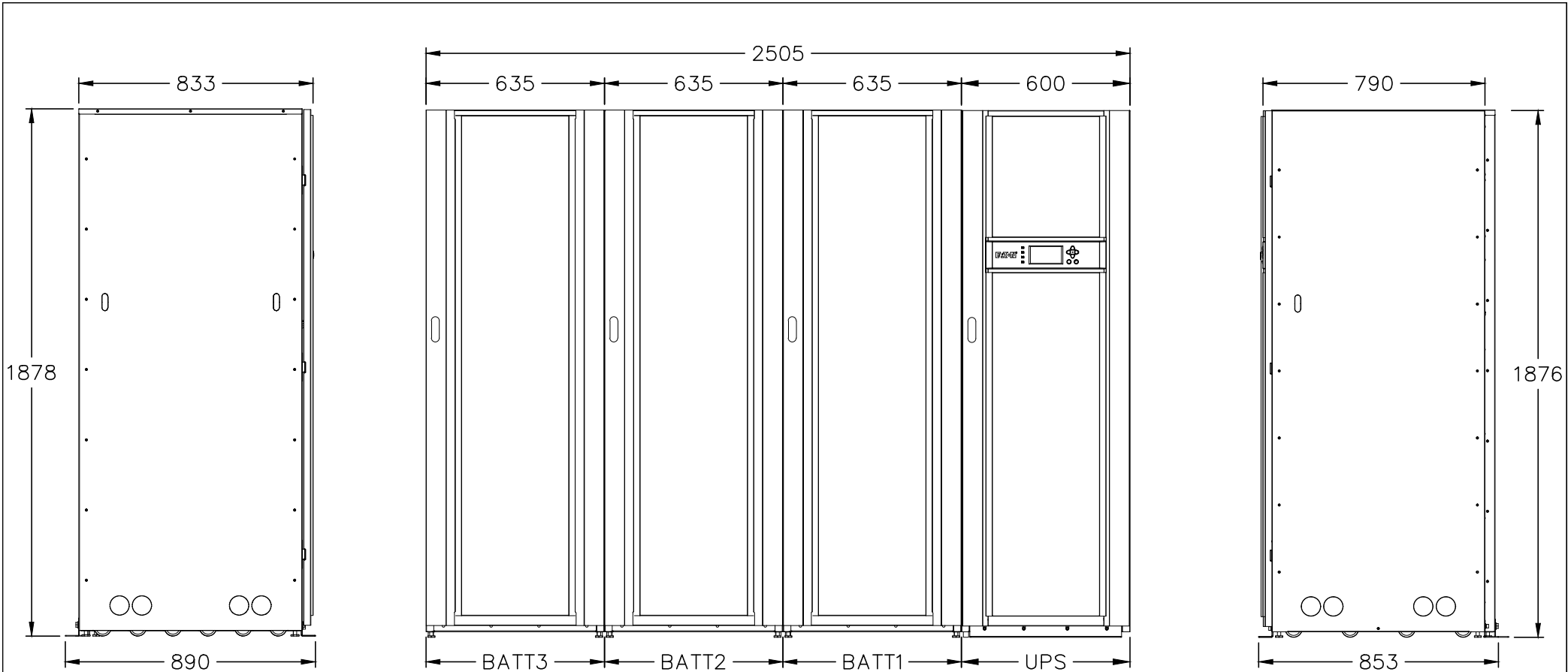

LEFT SIDE VIEW

FRONT VIEW

RIGHT SIDE VIEW

BATTERY				
PART NUMBER	93EEBCI150C40XXX	93EEBCI200C40XXX	93EEBCI280C40XXX	93EEBCI320D40XXX
RATING (PER CELL)	150kg	200kg	280kg	320kg
NUMBER OF CELLS	40	40	40	40
MASS	707kg	941kg	1269kg	1317kg

UPS					
PART NUMBER	93E80U-MBS	93E100N-MBS	93E120N-MBS	93E160I-IB	93E200N-IB
RATING	80kVA	100kVA	120kVA	160kVA	200kVA
MASS	283kg	283kg	311kg	457kg	457kg

- NOTES:**
- UPS AND BATTERY CABINETS HAVE A BLACK RAL 9005 POWDERCOATED FINISH.
 - MINIMUM CLEARANCES FOR VENTILATION & SERVICE AROUND THE UPS CABINET ARE REQUIRED.

EATON	DRAWN AA	SCALE NTS	FILENAME:	A4
	17.04.14			
	TITLE GENERAL ARRANGEMENT 93E 80-200kW +3xL-BAT (LEFT)			
AS-1100 THIRD ANGLE PROJECTION			UNLESS OTHERWISE SPECIFIED ALL DIMENSIONS IN MILLIMETRES.	DRAWING NUMBER A4GA0019
				REV 0

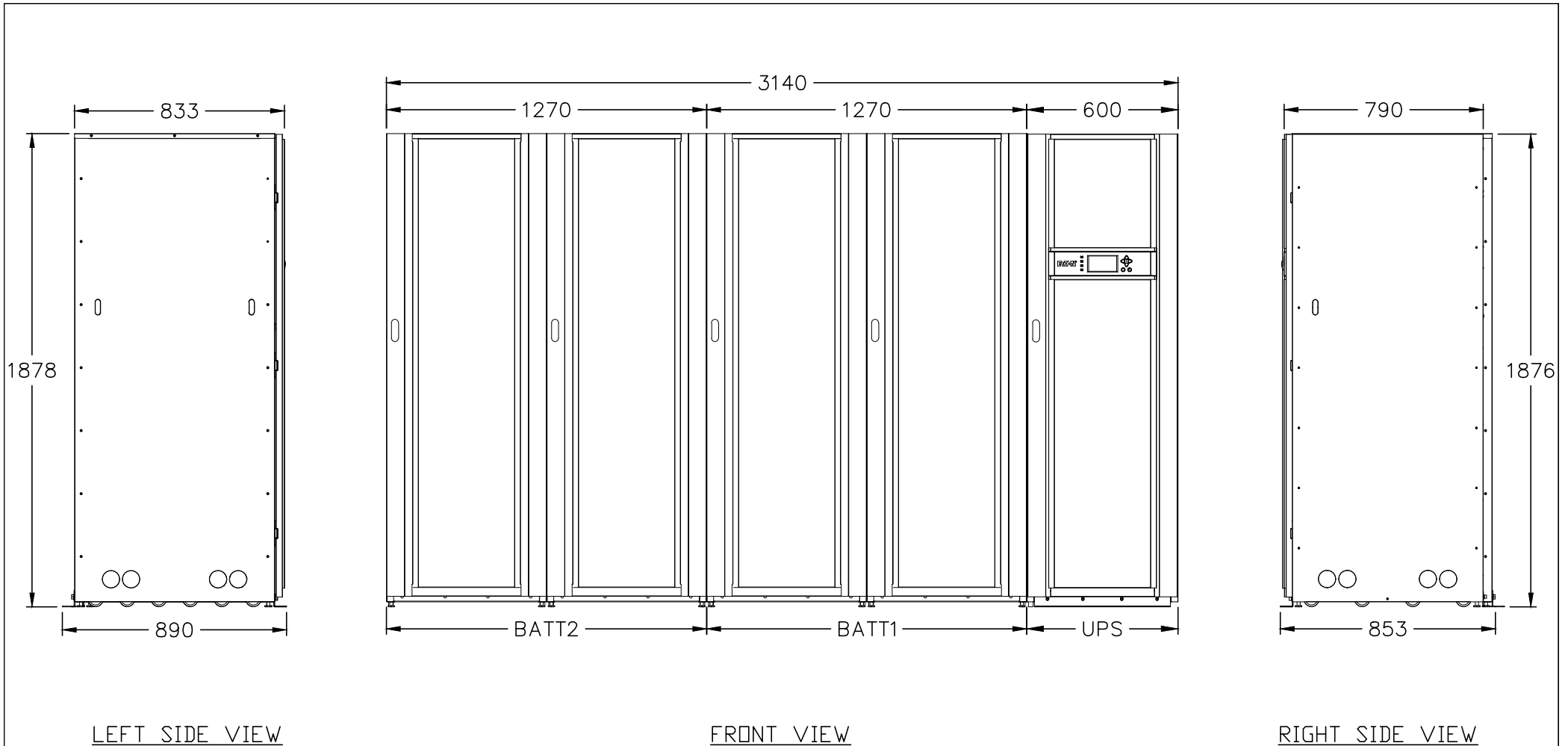

LEFT SIDE VIEW

FRONT VIEW

RIGHT SIDE VIEW

BATTERY			
PART NUMBER	93EEBCII390C40XXX	93EEBCII500C40XXX	93EEBCII620C40XXX
RATING (PER CELL)	390W	500W	620W
NUMBER OF CELLS	40	40	40
MASS	1765kg	2273kg	2333kg

UPS					
PART NUMBER	93E80U-MBS	93E100N-MBS	93E120N-MBS	93E160I-IB	93E200N-IB
RATING	80kVA	100kVA	120kVA	160kVA	200kVA
MASS	283kg	283kg	311kg	457kg	457kg

- NOTES:**
- UPS AND BATTERY CABINETS HAVE A BLACK RAL 9005 POWDERCOATED FINISH.
 - MINIMUM CLEARANCES FOR VENTILATION & SERVICE AROUND THE UPS CABINET ARE REQUIRED.

EATON	DRAWN AA	SCALE NTS	FILENAME:	A4
	17.04.14			
	TITLE GENERAL ARRANGEMENT 93E 80-200kW +2xLL-BAT (LEFT)			
DRAWING NUMBER A4GA0020			REV 0	

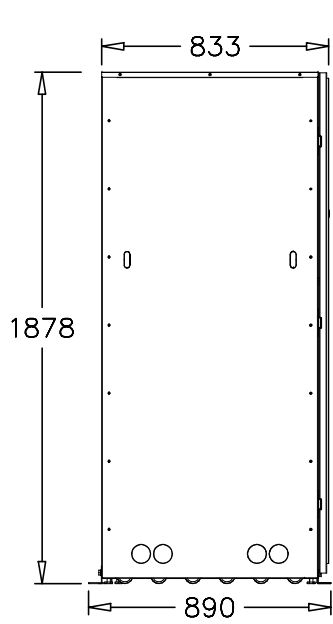

LEFT SIDE VIEW

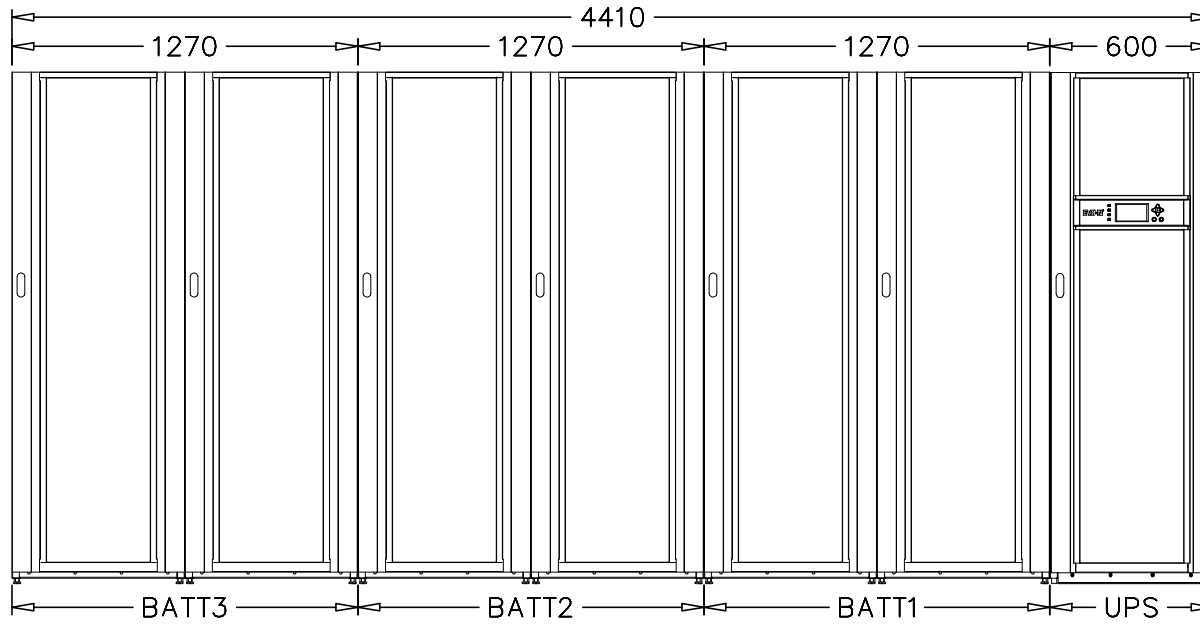

FRONT VIEW

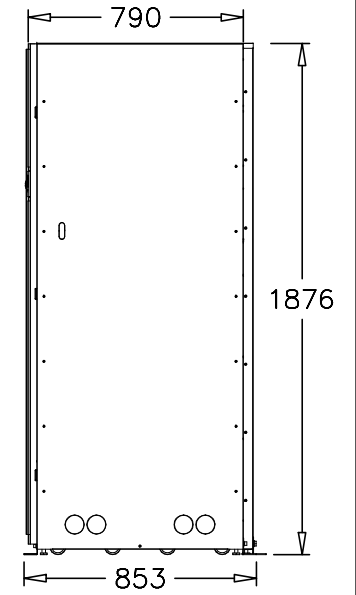

RIGHT SIDE VIEW

BATTERY			
PART NUMBER	93EEBCII390C40XXX	93EEBCII500C40XXX	93EEBCII620C40XXX
RATING (PER CELL)	390W	500W	620W
NUMBER OF CELLS	40	40	40
MASS	1765kg	2273kg	2333kg

UPS					
PART NUMBER	93E80U-MBS	93E100N-MBS	93E120N-MBS	93E160I-IB	93E200N-IB
RATING	80kVA	100kVA	120kVA	160kVA	200kVA
MASS	283kg	283kg	311kg	457kg	457kg

- NOTES:
- UPS AND BATTERY CABINETS HAVE A BLACK RAL 9005 POWDERCOATED FINISH.
 - MINIMUM CLEARANCES FOR VENTILATION & SERVICE AROUND THE UPS CABINET ARE REQUIRED.

EATON	DRAWN AA	SCALE NTS	FILENAME:	A4
	17.04.14			
	TITLE GENERAL ARRANGEMENT 93E 80-200kW + 3xLL-BAT (LEFT)			
DRAWING NUMBER A4GA0021			REV 0	

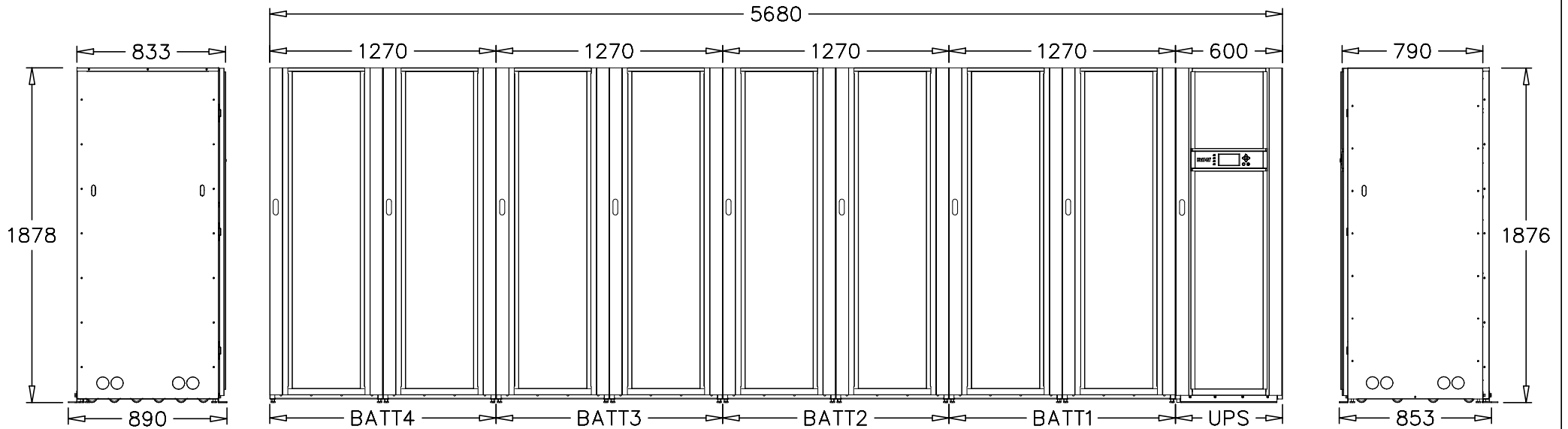

LEFT SIDE VIEW

FRONT VIEW

RIGHT SIDE VIEW

BATTERY			
PART NUMBER	93EEBCII390C40XXX	93EEBCII500C40XXX	93EEBCII620C40XXX
RATING (PER CELL)	390W	500W	620W
NUMBER OF CELLS	40	40	40
MASS	1765kg	2273kg	2333kg

UPS					
PART NUMBER	93E80U-MBS	93E100N-MBS	93E120N-MBS	93E160I-IB	93E200N-IB
RATING	80kVA	100kVA	120kVA	160kVA	200kVA
MASS	283kg	283kg	311kg	457kg	457kg

- NOTES:**
1. UPS AND BATTERY CABINETS HAVE A BLACK RAL 9005 POWDERCOATED FINISH.
 2. MINIMUM CLEARANCES FOR VENTILATION & SERVICE AROUND THE UPS CABINET ARE REQUIRED.

	<small>DRAWN</small> AA	<small>SCALE</small> NTS	<small>FILENAME:</small>	A4
	<small>17.04.14</small>	<small>TITLE</small> GENERAL ARRANGEMENT 93E 80-200kW + 4xLL-BAT (LEFT)		
	<small>AS-1100</small> <small>THIRD ANGLE PROJECTION</small>			<small>DRAWING NUMBER</small> A4GA0022

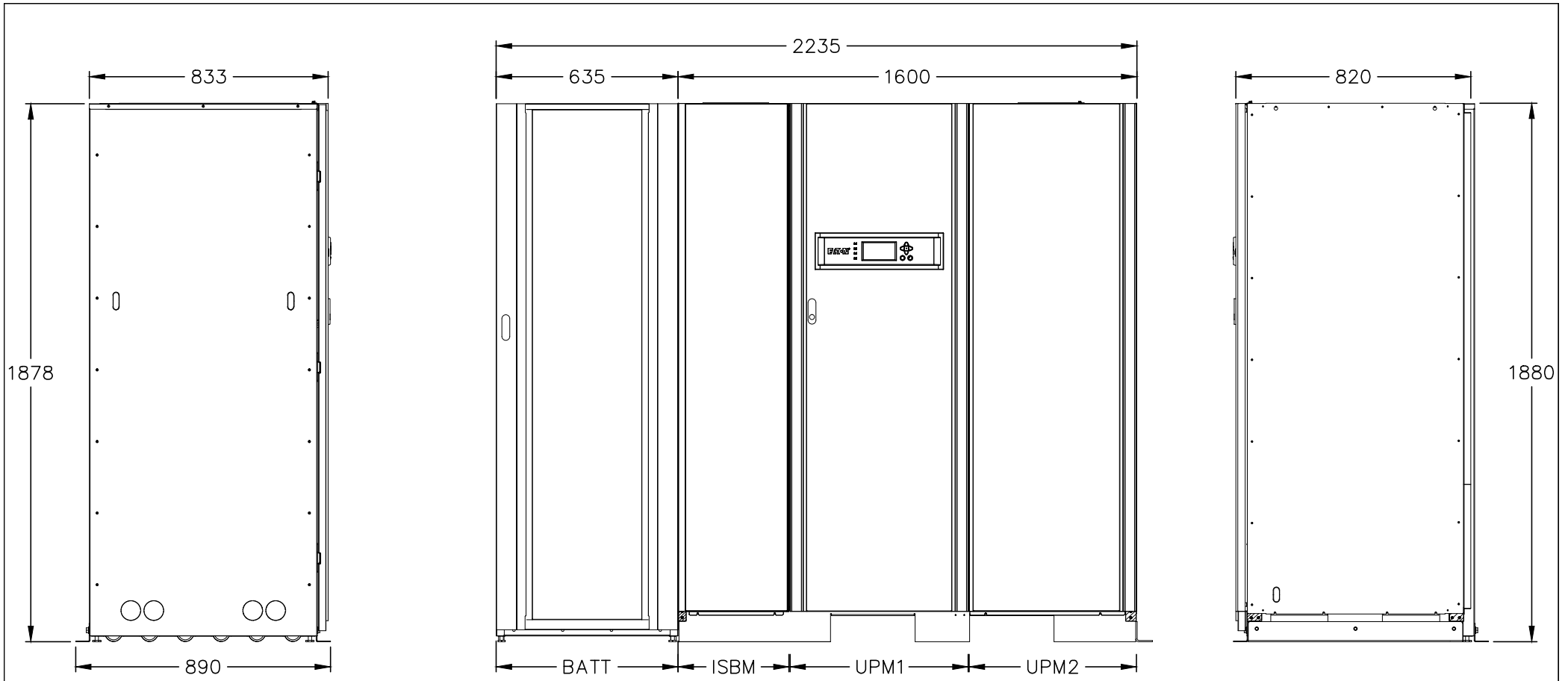

LEFT SIDE VIEW

FRONT VIEW

RIGHT SIDE VIEW

BATTERY				
PART NUMBER	93EEBCI150C40XXX	93EEBCI200C40XXX	93EEBCI280C40XXX	93EEBCI320D40XXX
RATING (PER CELL)	150kg	200kg	280kg	320kg
NUMBER OF CELLS	40	40	40	40
MASS	707kg	941kg	1269kg	1317kg

UPS		
PART NUMBER	93E300U-IB	93E400N-IB
RATING	300kVA	400kVA
MASS	970kg	970kg

- NOTES:**
- UPS AND BATTERY CABINETS HAVE A BLACK RAL 9005 POWDERCOATED FINISH.
 - MINIMUM CLEARANCES FOR VENTILATION & SERVICE AROUND THE UPS CABINET ARE REQUIRED.

EATON	DRAWN AA	SCALE NTS	FILENAME:	A4
	17.04.14			
	TITLE GENERAL ARRANGEMENT 93E 300-400kW +L-BAT (LEFT)			
AS-1100 THIRD ANGLE PROJECTION			UNLESS OTHERWISE SPECIFIED ALL DIMENSIONS IN MILLIMETRES.	DRAWING NUMBER A4GA0023
				REV 0

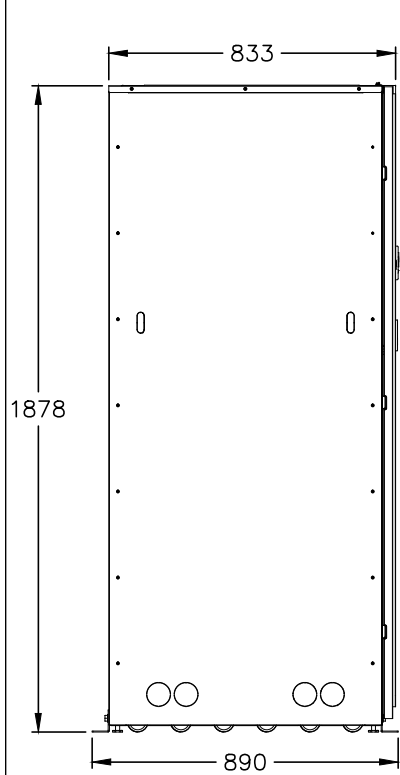

LEFT SIDE VIEW

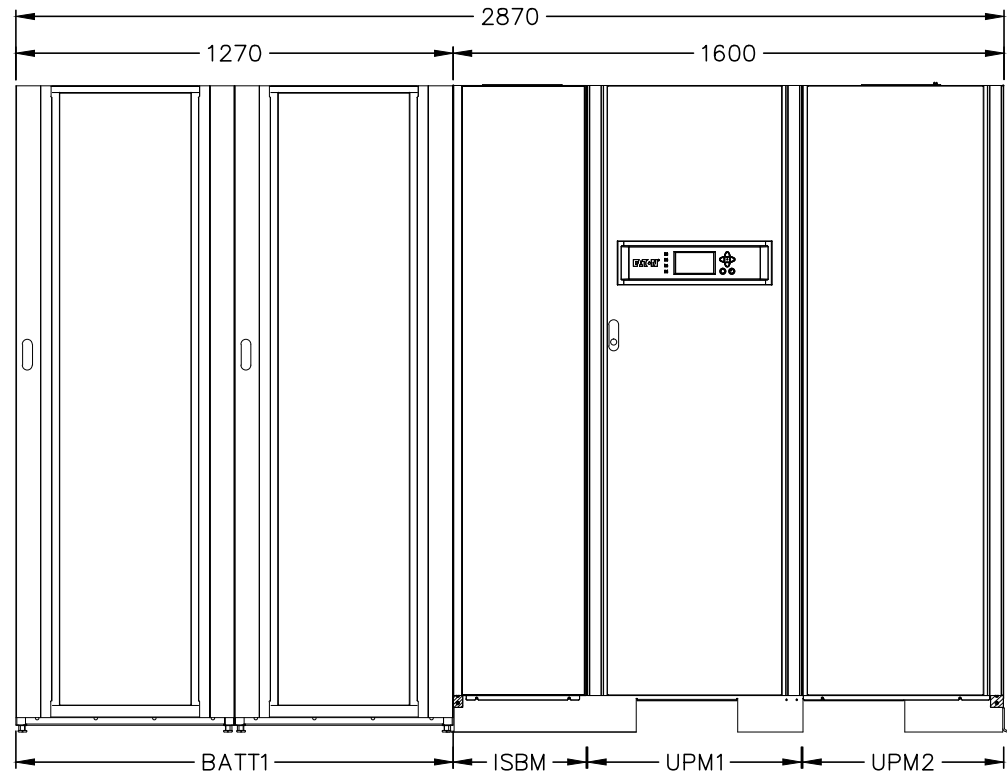

FRONT VIEW

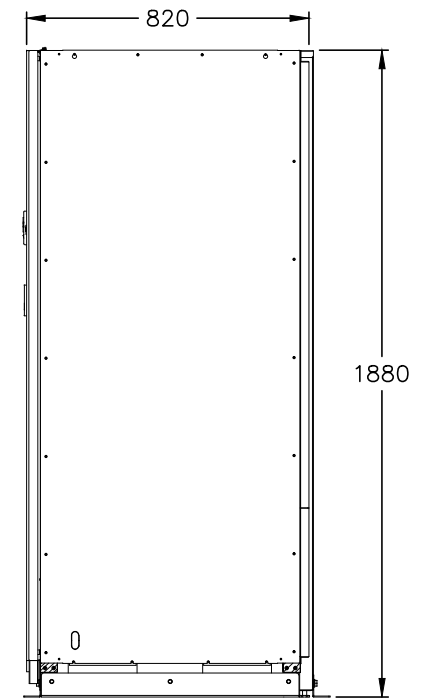

RIGHT SIDE VIEW

BATTERY			
PART NUMBER	93EEBCII390C40XXX	93EEBCII500C40XXX	93EEBCII620C40XXX
RATING (PER CELL)	390W	500W	620W
NUMBER OF CELLS	40	40	40
MASS	1765kg	2273kg	2333kg

UPS		
PART NUMBER	93E300U-IB	93E400N-IB
RATING	300kVA	400kVA
MASS	970kg	970kg

- NOTES:
- UPS AND BATTERY CABINETS HAVE A BLACK RAL 9005 POWDERCOATED FINISH.
 - MINIMUM CLEARANCES FOR VENTILATION & SERVICE AROUND THE UPS CABINET ARE REQUIRED.

	<small>DRAWN</small> AA 17.04.14	<small>SCALE</small> NTS	<small>FILENAME:</small>	A4
	<small>TITLE</small> GENERAL ARRANGEMENT 93E 300-400kW +LL-BAT (LEFT)			
	<small>DRAWING NUMBER</small> A4GA0024			<small>REV</small> 0

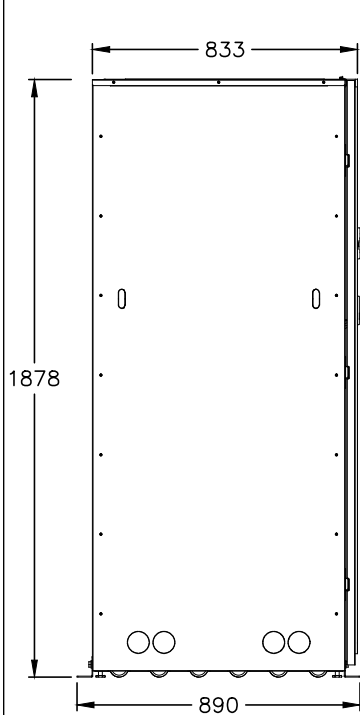

LEFT SIDE VIEW

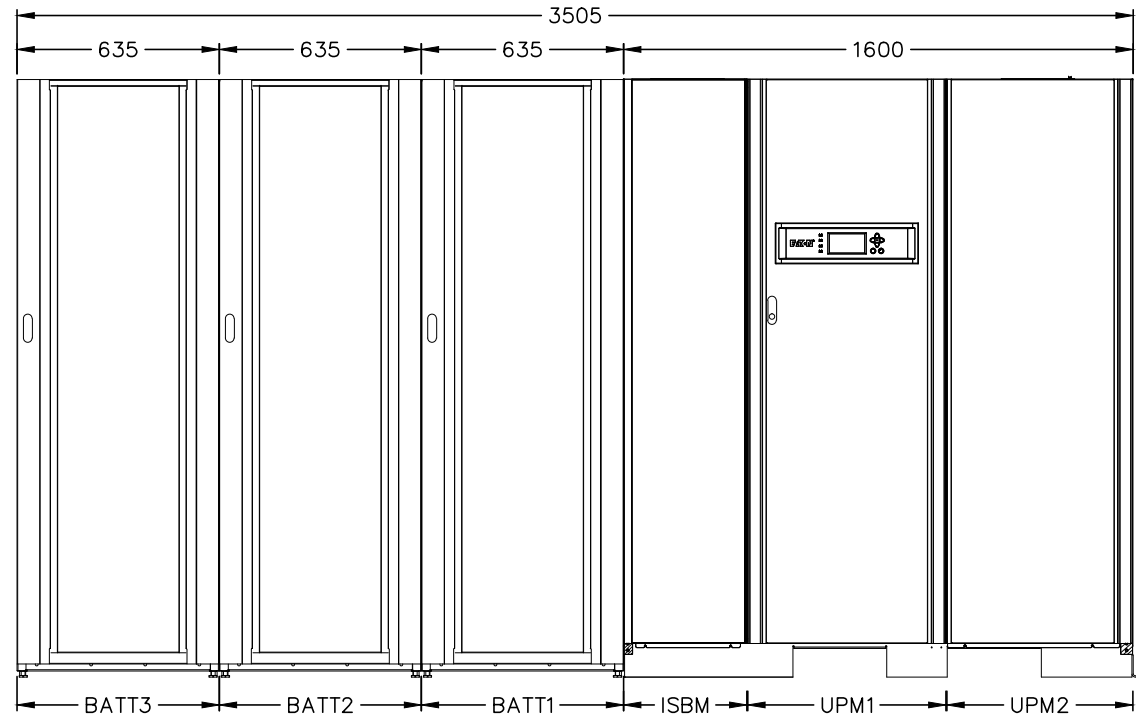

FRONT VIEW

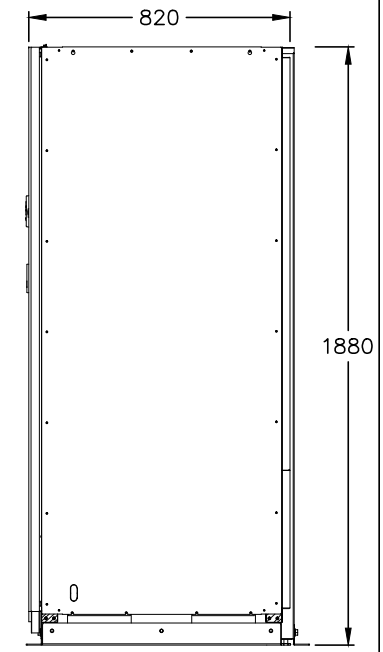

RIGHT SIDE VIEW

BATTERY				
PART NUMBER	93EEBC150C40XXX	93EEBC1200C40XXX	93EEBC1280C40XXX	93EEBC1320D40XXX
RATING (PER CELL)	150kg	200kg	280kg	320kg
NUMBER OF CELLS	40	40	40	40
MASS	707kg	941kg	1269kg	1317kg

UPS		
PART NUMBER	93E300U-IB	93E400N-IB
RATING	300kVA	400kVA
MASS	970kg	970kg

- NOTES:
- UPS AND BATTERY CABINETS HAVE A BLACK RAL 9005 POWDERCOATED FINISH.
 - MINIMUM CLEARANCES FOR VENTILATION & SERVICE AROUND THE UPS CABINET ARE REQUIRED.

	<small>DRAWN</small> AA	<small>SCALE</small> NTS	<small>FILENAME:</small>	A4
	<small>17.04.14</small>	<small>TITLE</small> GENERAL ARRANGEMENT 93E 300-400kW +3xL-BAT (LEFT)		
	<small>DRAWING NUMBER</small> A4GA0025		<small>REV</small> 0	
<small>AS-1100 THIRD ANGLE PROJECTION UNLESS OTHERWISE SPECIFIED ALL DIMENSIONS IN MILLIMETRES.</small>				

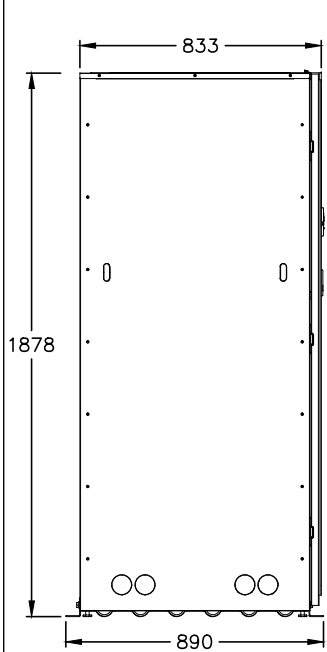

LEFT SIDE VIEW

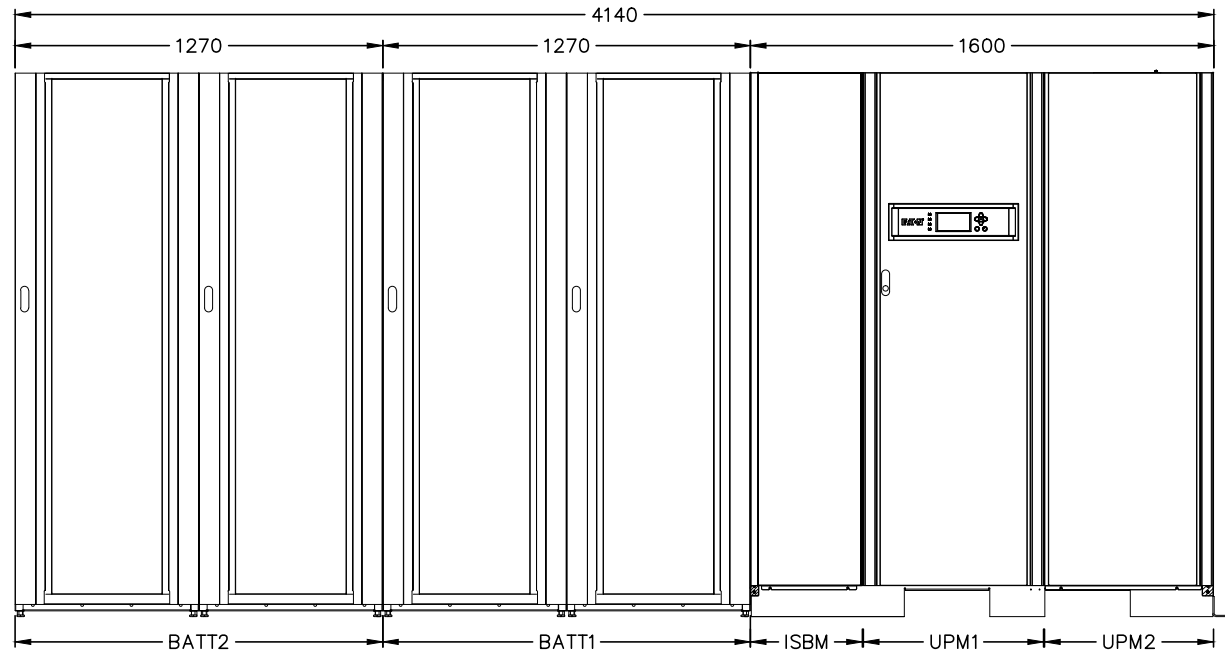

FRONT VIEW

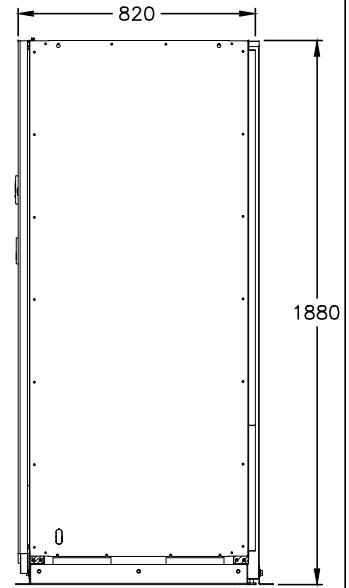

RIGHT SIDE VIEW

BATTERY			
PART NUMBER	93EEBCII390C40XXX	93EEBCII500C40XXX	93EEBCII620C40XXX
RATING (PER CELL)	390W	500W	620W
NUMBER OF CELLS	40	40	40
MASS	1765kg	2273kg	2333kg

UPS		
PART NUMBER	93E300U-IB	93E400N-IB
RATING	300kVA	400kVA
MASS	970kg	970kg

- NOTES:
- UPS AND BATTERY CABINETS HAVE A BLACK RAL 9005 POWDERCOATED FINISH.
 - MINIMUM CLEARANCES FOR VENTILATION & SERVICE AROUND THE UPS CABINET ARE REQUIRED.

	<small>DRAWN</small> AA 17.04.14	<small>SCALE</small> NTS	<small>FILENAME:</small>	A4
	<small>TITLE</small> GENERAL ARRANGEMENT 93E 300-400kW +2xLL-BAT (LEFT)			
	<small>DRAWING NUMBER</small> A4GA0026			<small>REV</small> 0

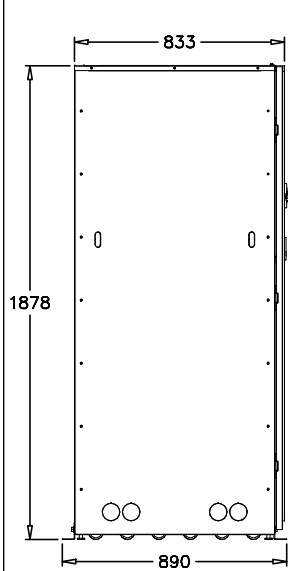

LEFT SIDE VIEW

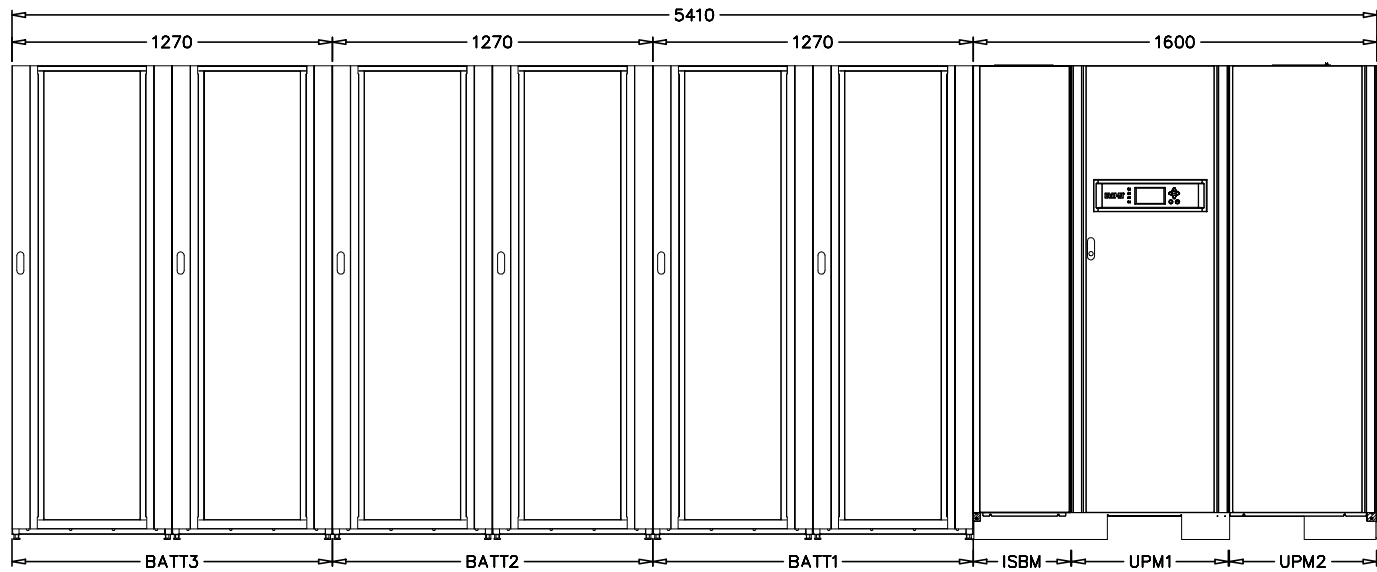

FRONT VIEW

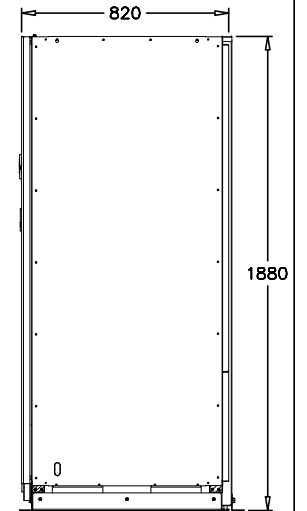

RIGHT SIDE VIEW

BATTERY			
PART NUMBER	93EEBCII390C40XXX	93EEBCII500C40XXX	93EEBCII620C40XXX
RATING (PER CELL)	390W	500W	620W
NUMBER OF CELLS	40	40	40
MASS	1765kg	2273kg	2333kg

UPS		
PART NUMBER	93E300U-IB	93E400N-IB
RATING	300kVA	400kVA
MASS	970kg	970kg

- NOTES:**
- UPS AND BATTERY CABINETS HAVE A BLACK RAL 9005 POWDERCOATED FINISH.
 - MINIMUM CLEARANCES FOR VENTILATION & SERVICE AROUND THE UPS CABINET ARE REQUIRED.

	<small>DRAWN</small> AA 17.04.14	<small>SCALE</small> NTS	<small>FILENAME:</small>	A4
	<small>TITLE</small> GENERAL ARRANGEMENT 93E 300-400kW + 3xLL-BAT (LEFT)			
	<small>DRAWING NUMBER</small> A4GA0027			<small>REV</small> 0

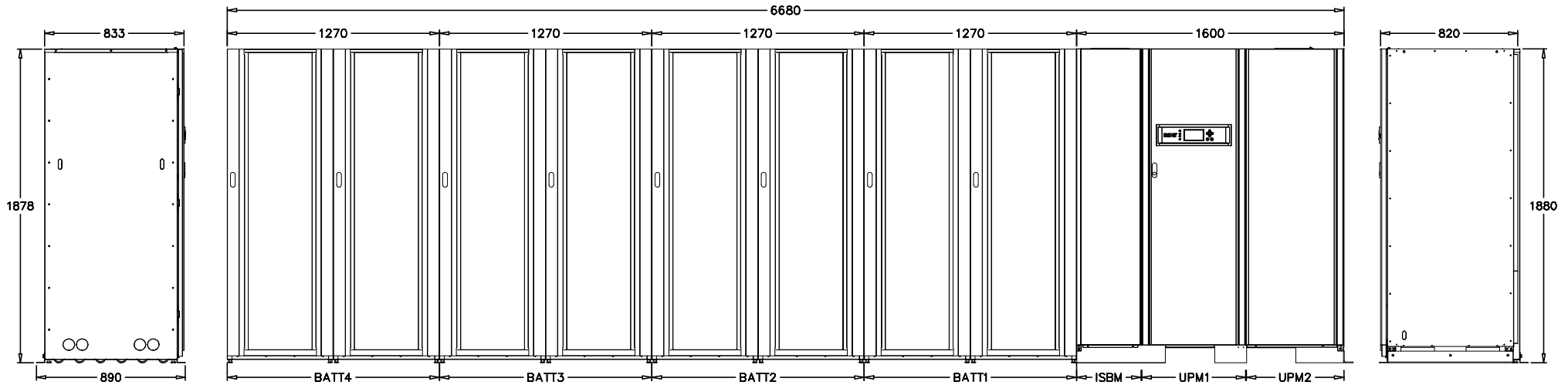

LEFT SIDE VIEW

FRONT VIEW

RIGHT SIDE VIEW

BATTERY			
PART NUMBER	93EEBCII390C40XXX	93EEBCII500C40XXX	93EEBCII620C40XXX
RATING (PER CELL)	390W	500W	620W
NUMBER OF CELLS	40	40	40
MASS	1765kg	2273kg	2333kg

UPS		
PART NUMBER	93E300U-IB	93E400N-IB
RATING	300kVA	400kVA
MASS	970kg	970kg

- NOTES:**
- UPS AND BATTERY CABINETS HAVE A BLACK RAL 9005 POWDERCOATED FINISH.
 - MINIMUM CLEARANCES FOR VENTILATION & SERVICE AROUND THE UPS CABINET ARE REQUIRED.

	<small>DRAWN</small> AA	<small>SCALE</small> NTS	<small>FILENAME:</small>	A4
	<small>17.04.14</small>	<small>TITLE</small> GENERAL ARRANGEMENT 93E 300-400kW + 4xLL-BAT (LEFT)		
	<small>DRAWING NUMBER</small> A4GA0028			<small>REV</small> 0
<small>AS-1100</small> <small>THIRD ANGLE PROJECTION</small>		<small>UNLESS OTHERWISE SPECIFIED ALL</small> <small>DIMENSIONS IN MILLIMETRES.</small>		

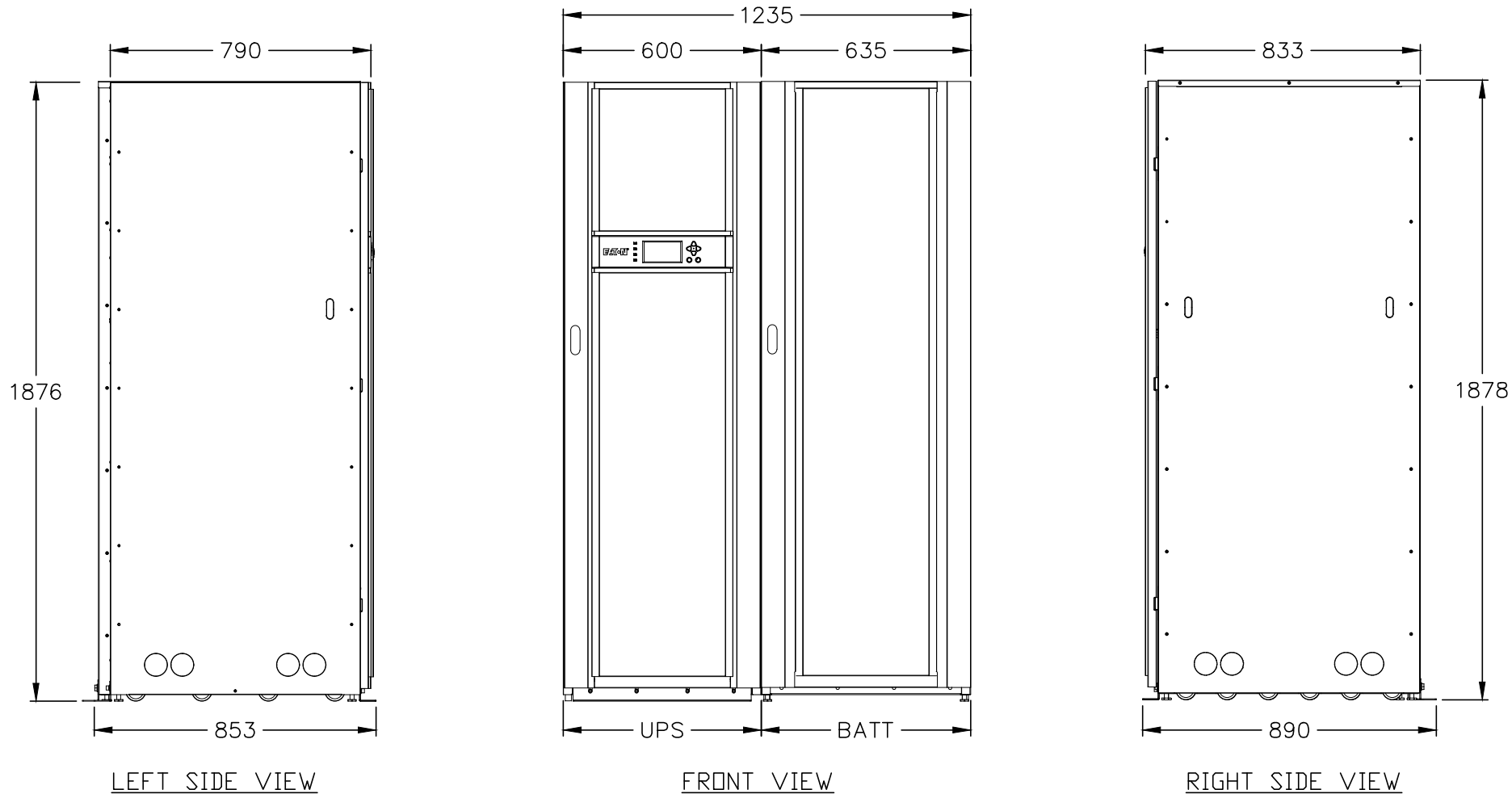

LEFT SIDE VIEW

FRONT VIEW

RIGHT SIDE VIEW

BATTERY

PART NUMBER	93EEBCI150C40XXX	93EEBCI200C40XXX	93EEBCI280C40XXX	93EEBCI320D40XXX
RATING (PER CELL)	150kg	200kg	280kg	320kg
NUMBER OF CELLS	40	40	40	40
MASS	707kg	941kg	1269kg	1317kg

UPS

PART NUMBER	93E80U-MBS	93E100N-MBS	93E120N-MBS	93E160I-IB	93E200N-IB
RATING	80kVA	100kVA	120kVA	160kVA	200kVA
MASS	283kg	283kg	311kg	457kg	457kg

- NOTES:
- UPS AND BATTERY CABINETS HAVE A BLACK RAL 9005 POWDERCOATED FINISH.
 - MINIMUM CLEARANCES FOR VENTILATION & SERVICE AROUND THE UPS CABINET ARE REQUIRED.

	<small>DRAWN</small> AA 17.04.14	<small>SCALE</small> NTS	<small>FILENAME:</small>	A4
	<small>TITLE</small> GENERAL ARRANGEMENT 93E 80-200kW +L-BAT (RIGHT)			
	<small>DRAWING NUMBER</small> A4GA0029			<small>REV</small> 0

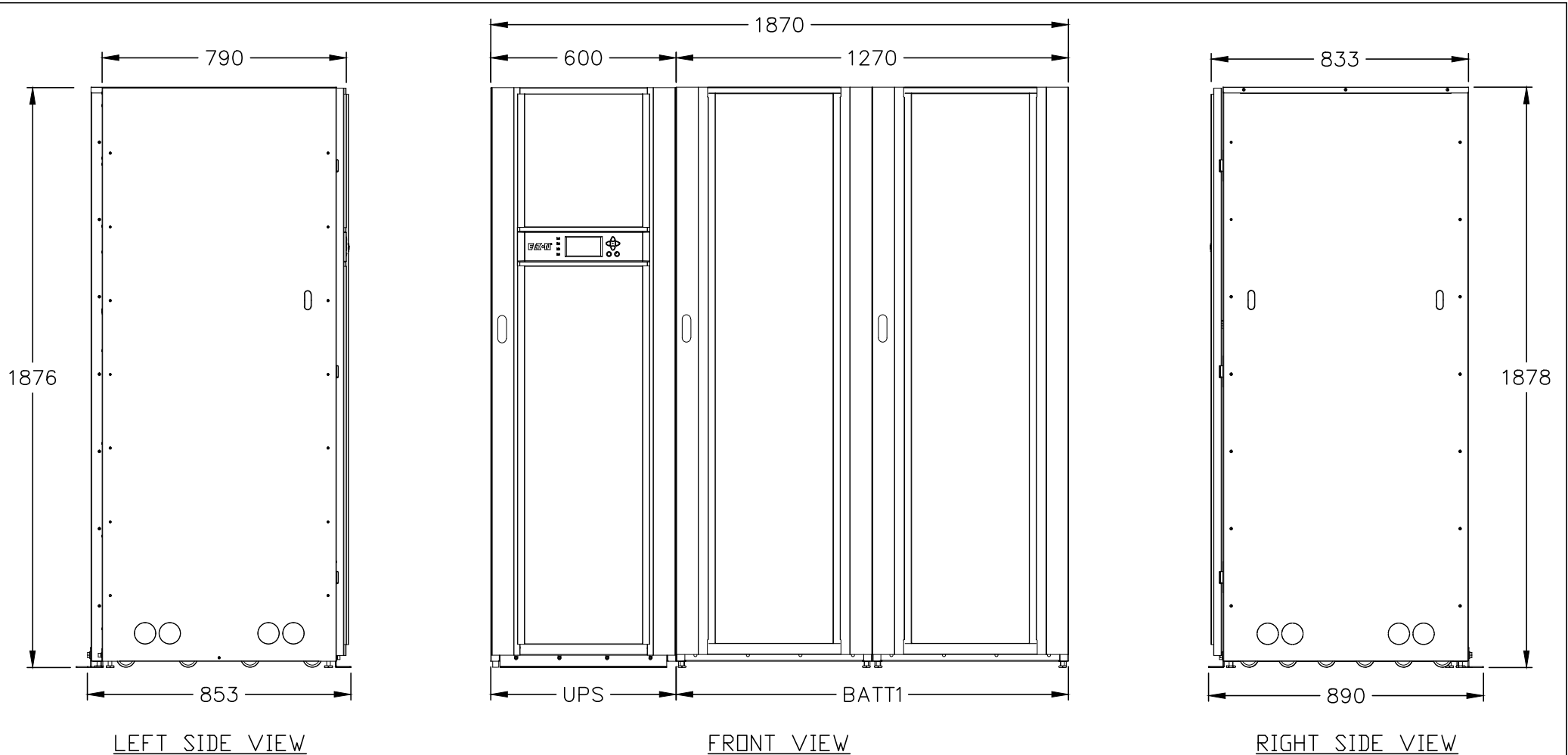

LEFT SIDE VIEW

FRONT VIEW

RIGHT SIDE VIEW

BATTERY			
PART NUMBER	93EEBCII390C40XXX	93EEBCII500C40XXX	93EEBCII620C40XXX
RATING (PER CELL)	390W	500W	620W
NUMBER OF CELLS	40	40	40
MASS	1765kg	2273kg	2333kg

UPS					
PART NUMBER	93E80U-MBS	93E100N-MBS	93E120N-MBS	93E160I-IB	93E200N-IB
RATING	80kVA	100kVA	120kVA	160kVA	200kVA
MASS	283kg	283kg	311kg	457kg	457kg

- NOTES:
- UPS AND BATTERY CABINETS HAVE A BLACK RAL 9005 POWDERCOATED FINISH.
 - MINIMUM CLEARANCES FOR VENTILATION & SERVICE AROUND THE UPS CABINET ARE REQUIRED.

	<small>DRAWN</small> AA 17.04.14	<small>SCALE</small> NTS	<small>FILENAME:</small>	A4
	<small>TITLE</small> GENERAL ARRANGEMENT 93E 80-200kW +LL-BAT (RIGHT)			
	<small>DRAWING NUMBER</small> A4GA0030			<small>REV</small> 0

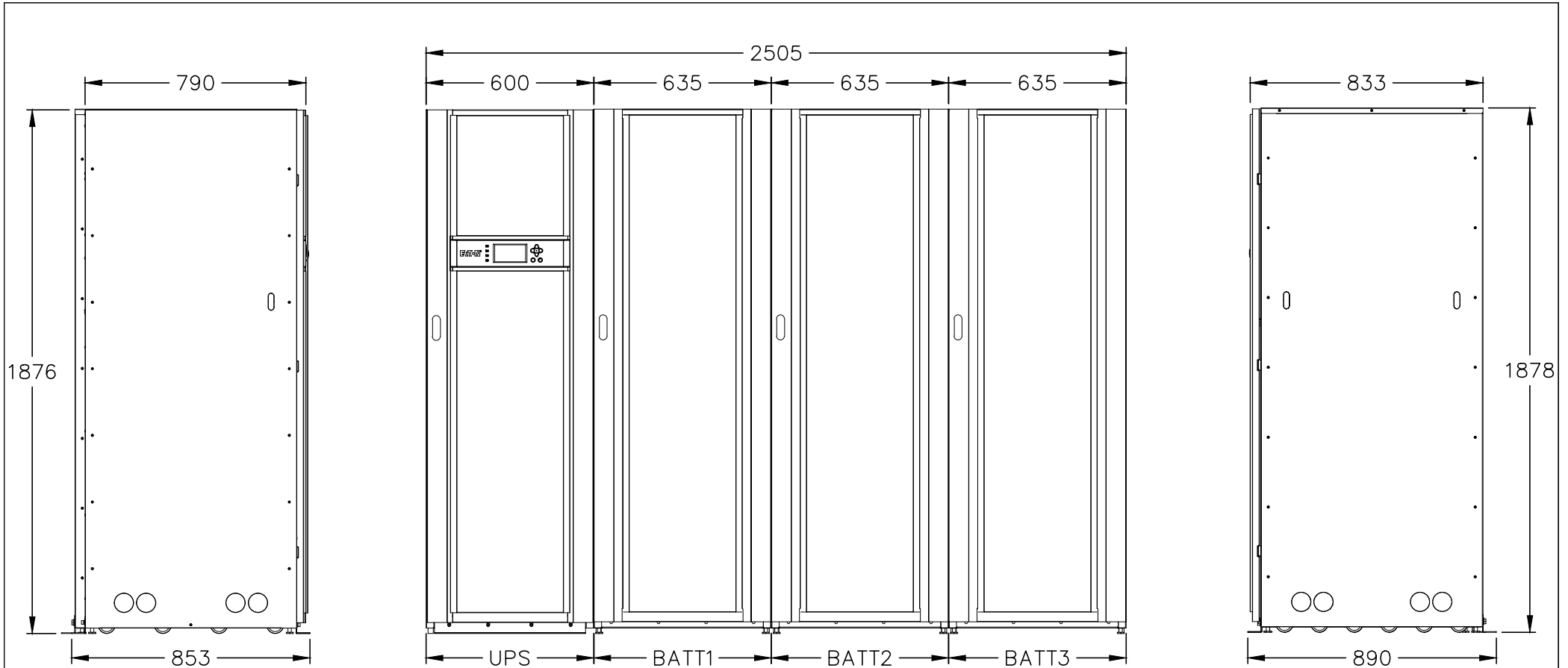

LEFT SIDE VIEW

FRONT VIEW

RIGHT SIDE VIEW

BATTERY				
PART NUMBER	93EEBCI150C40XXX	93EEBCI200C40XXX	93EEBCI280C40XXX	93EEBCI320D40XXX
RATING (PER CELL)	150kg	200kg	280kg	320kg
NUMBER OF CELLS	40	40	40	40
MASS	707kg	941kg	1269kg	1317kg

UPS					
PART NUMBER	93E80U-MBS	93E100N-MBS	93E120N-MBS	93E160I-IB	93E200N-IB
RATING	80kVA	100kVA	120kVA	160kVA	200kVA
MASS	283kg	283kg	311kg	457kg	457kg

- NOTES:
- UPS AND BATTERY CABINETS HAVE A BLACK RAL 9005 POWDERCOATED FINISH.
 - MINIMUM CLEARANCES FOR VENTILATION & SERVICE AROUND THE UPS CABINET ARE REQUIRED.

EATON	DRAWN AA	SCALE NTS	FILENAME:	A4
	17.04.14			
	TITLE GENERAL ARRANGEMENT 93E 80-200kW +3xL-BAT (RIGHT)			
DRAWING NUMBER A4GA0031			REV 0	

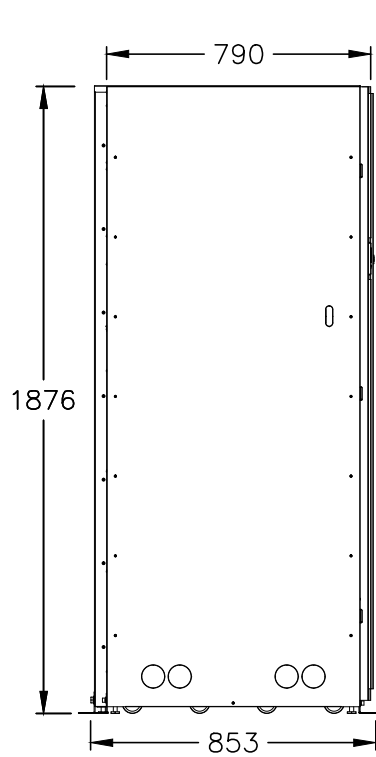

LEFT SIDE VIEW

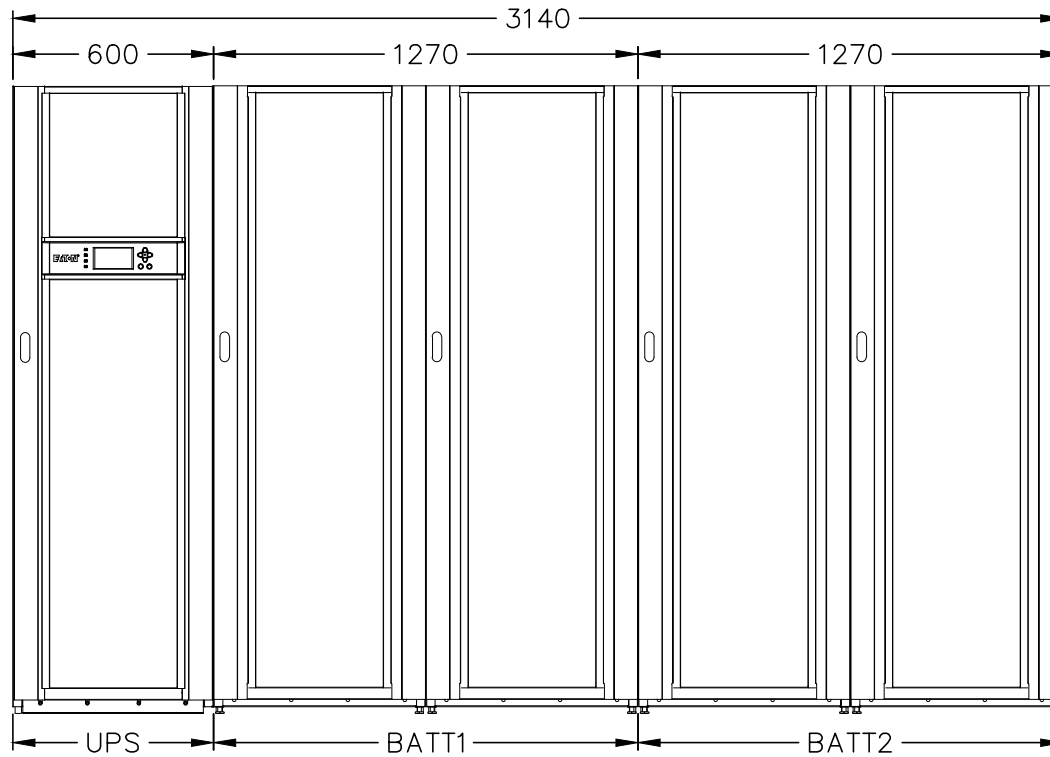

FRONT VIEW

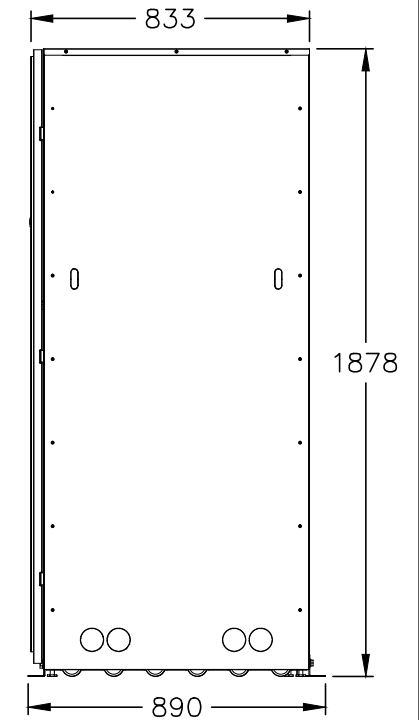

RIGHT SIDE VIEW

BATTERY			
PART NUMBER	93EEBCII390C40XXX	93EEBCII500C40XXX	93EEBCII620C40XXX
RATING (PER CELL)	390W	500W	620W
NUMBER OF CELLS	40	40	40
MASS	1765kg	2273kg	2333kg

UPS					
PART NUMBER	93E80U-MBS	93E100N-MBS	93E120N-MBS	93E160I-IB	93E200N-IB
RATING	80kVA	100kVA	120kVA	160kVA	200kVA
MASS	283kg	283kg	311kg	457kg	457kg

- NOTES:
- UPS AND BATTERY CABINETS HAVE A BLACK RAL 9005 POWDERCOATED FINISH.
 - MINIMUM CLEARANCES FOR VENTILATION & SERVICE AROUND THE UPS CABINET ARE REQUIRED.

EATON	DRAWN AA	SCALE NTS	FILENAME:	A4
	17.04.14			
	TITLE GENERAL ARRANGEMENT 93E 80-200kW +2xLL-BAT (RIGHT)			
DRAWING NUMBER A4GA0032			REV 0	

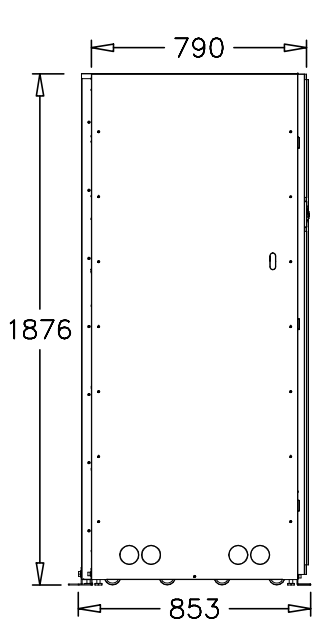

LEFT SIDE VIEW

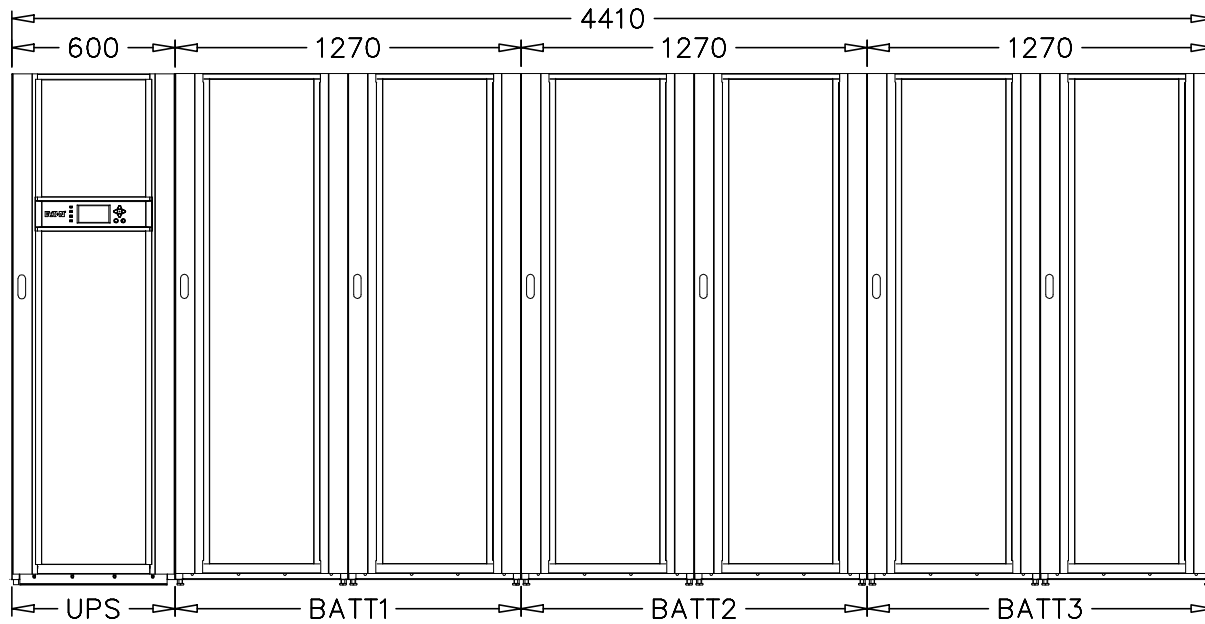

FRONT VIEW

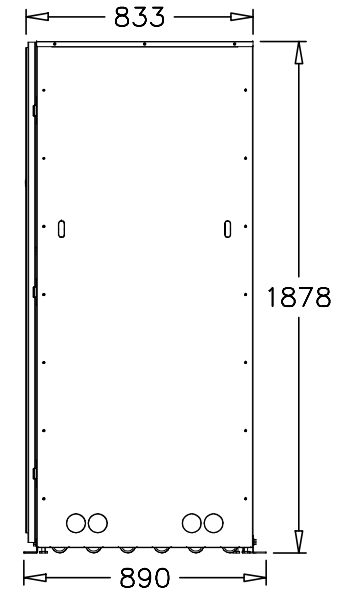

RIGHT SIDE VIEW

BATTERY			
PART NUMBER	93EEBCII390C40XXX	93EEBCII500C40XXX	93EEBCII620C40XXX
RATING (PER CELL)	390W	500W	620W
NUMBER OF CELLS	40	40	40
MASS	1765kg	2273kg	2333kg

UPS					
PART NUMBER	93E80U-MBS	93E100N-MBS	93E120N-MBS	93E160I-IB	93E200N-IB
RATING	80kVA	100kVA	120kVA	160kVA	200kVA
MASS	283kg	283kg	311kg	457kg	457kg

- NOTES:
- UPS AND BATTERY CABINETS HAVE A BLACK RAL 9005 POWDERCOATED FINISH.
 - MINIMUM CLEARANCES FOR VENTILATION & SERVICE AROUND THE UPS CABINET ARE REQUIRED.

EATON	DRAWN AA	SCALE NTS	FILENAME:	A4
	17.04.14			
	TITLE GENERAL ARRANGEMENT 93E 80-200kW + 3xLL-BAT (RIGHT)			
DRAWING NUMBER A4GA0033			REV 0	

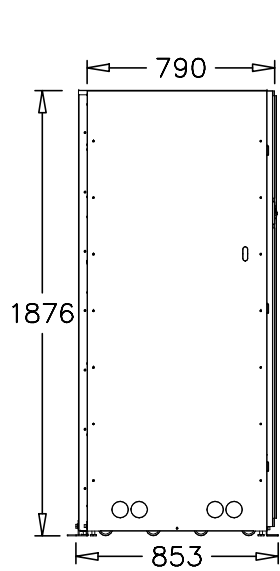

LEFT SIDE VIEW

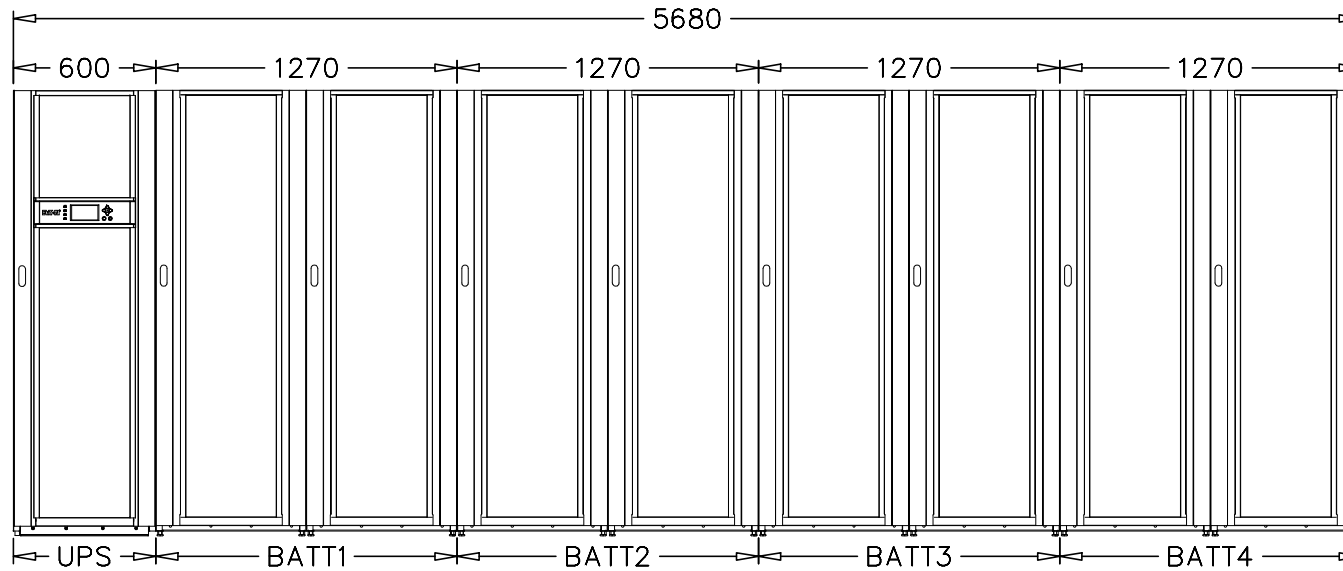

FRONT VIEW

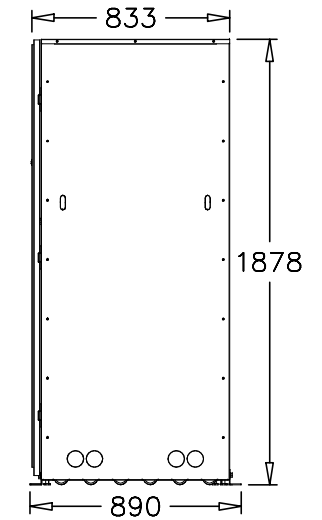

RIGHT SIDE VIEW

BATTERY			
PART NUMBER	93EEBCII390C40XXX	93EEBCII500C40XXX	93EEBCII620C40XXX
RATING (PER CELL)	390W	500W	620W
NUMBER OF CELLS	40	40	40
MASS	1765kg	2273kg	2333kg

UPS					
PART NUMBER	93E80U-MBS	93E100N-MBS	93E120N-MBS	93E160I-IB	93E200N-IB
RATING	80kVA	100kVA	120kVA	160kVA	200kVA
MASS	283kg	283kg	311kg	457kg	457kg

- NOTES:**
- UPS AND BATTERY CABINETS HAVE A BLACK RAL 9005 POWDERCOATED FINISH.
 - MINIMUM CLEARANCES FOR VENTILATION & SERVICE AROUND THE UPS CABINET ARE REQUIRED.

EATON	DRAWN AA 17.04.14	SCALE NTS	FILENAME:	A4
	TITLE GENERAL ARRANGEMENT 93E 80-200kW + 4xLL-BAT (RIGHT)			
	DRAWING NUMBER A4GA0034			REV 0

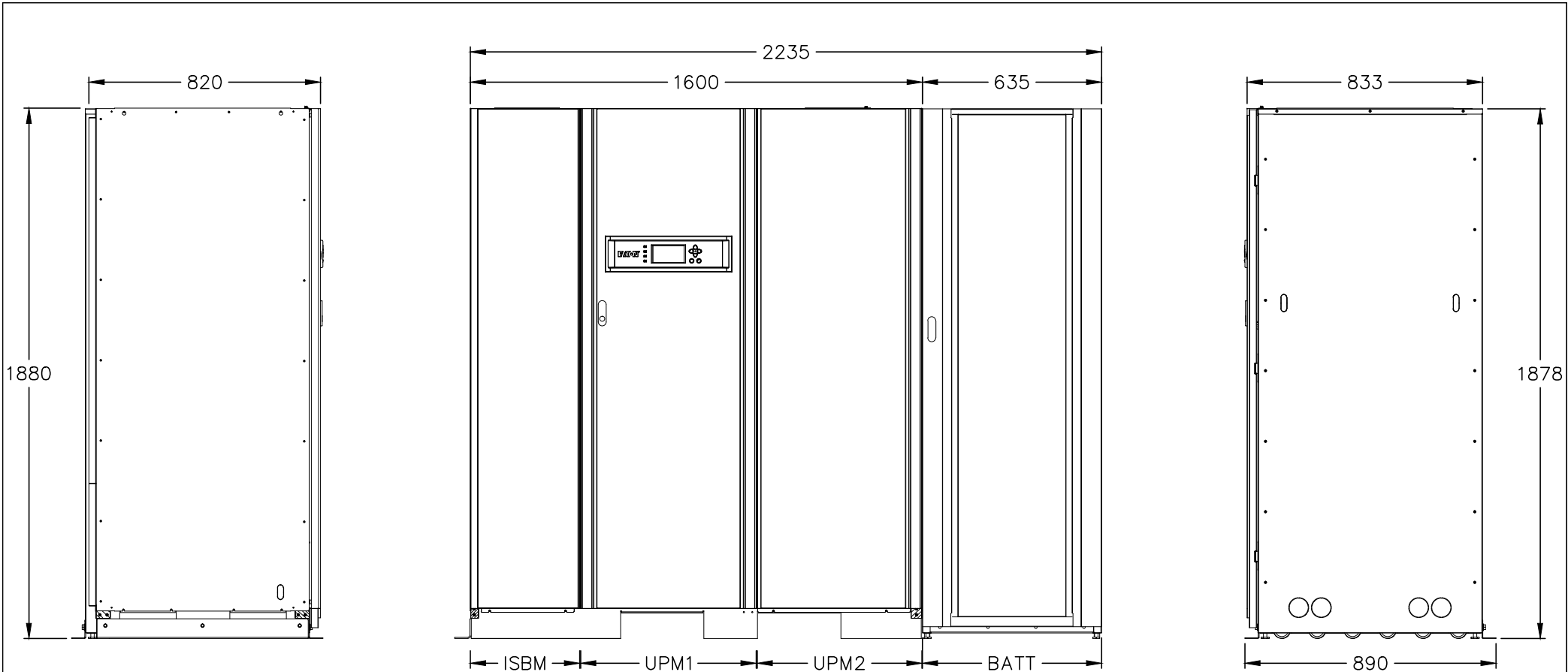

LEFT SIDE VIEW

FRONT VIEW

RIGHT SIDE VIEW

BATTERY				
PART NUMBER	93EEBCI150C40XXX	93EEBCI200C40XXX	93EEBCI280C40XXX	93EEBCI320D40XXX
RATING (PER CELL)	150kg	200kg	280kg	320kg
NUMBER OF CELLS	40	40	40	40
MASS	707kg	941kg	1269kg	1317kg

UPS		
PART NUMBER	93E300U-IB	93E400N-IB
RATING	300kVA	400kVA
MASS	970kg	970kg

- NOTES:**
- UPS AND BATTERY CABINETS HAVE A BLACK RAL 9005 POWDERCOATED FINISH.
 - MINIMUM CLEARANCES FOR VENTILATION & SERVICE AROUND THE UPS CABINET ARE REQUIRED.

EATON	DRAWN AA	SCALE NTS	FILENAME:	A4
	17.04.14			
	TITLE GENERAL ARRANGEMENT 93E 300-400kW +L-BAT (RIGHT)			
AS-1100 THIRD ANGLE PROJECTION			UNLESS OTHERWISE SPECIFIED ALL DIMENSIONS IN MILLIMETRES.	DRAWING NUMBER A4GA0035
				REV 0

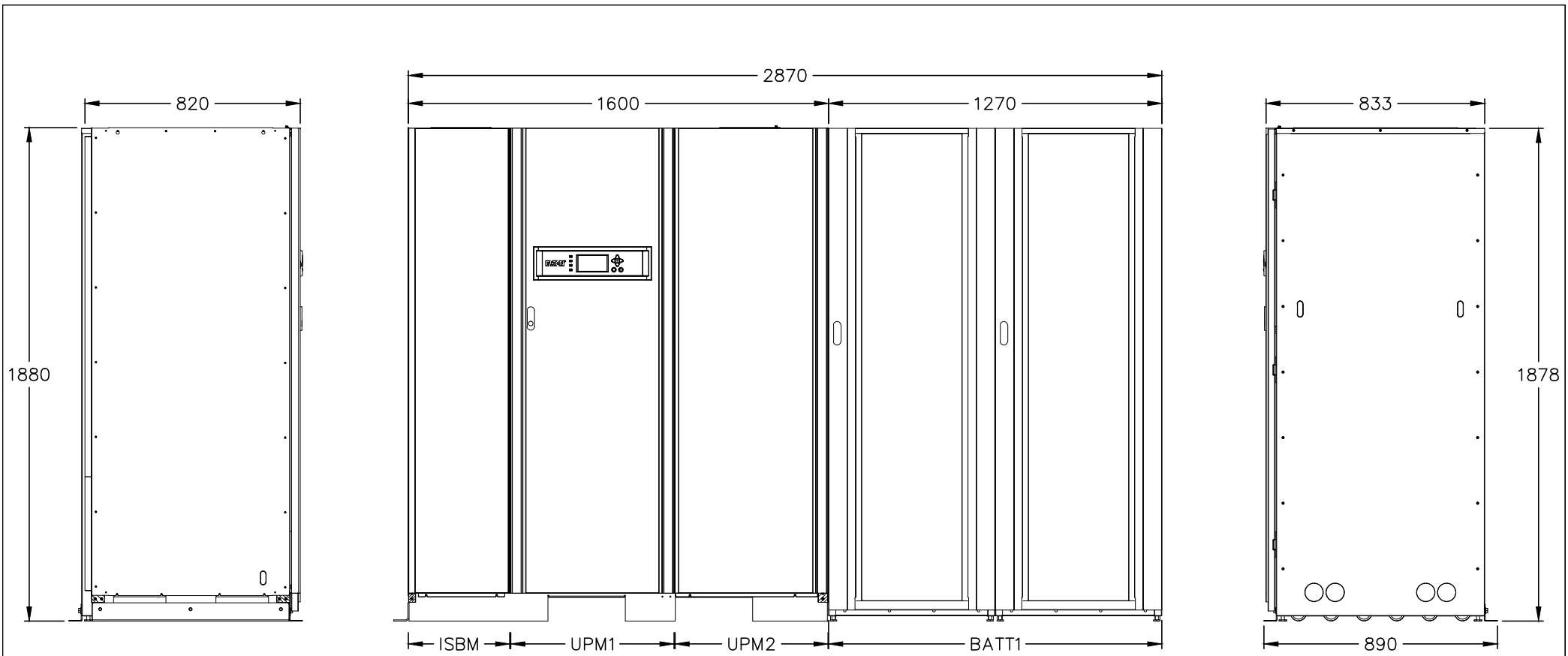

LEFT SIDE VIEW

FRONT VIEW

RIGHT SIDE VIEW

BATTERY			
PART NUMBER	93EEBCII390C40XXX	93EEBCII500C40XXX	93EEBCII620C40XXX
RATING (PER CELL)	390W	500W	620W
NUMBER OF CELLS	40	40	40
MASS	1765kg	2273kg	2333kg

UPS		
PART NUMBER	93E300U-IB	93E400N-IB
RATING	300kVA	400kVA
MASS	970kg	970kg

- NOTES:
- UPS AND BATTERY CABINETS HAVE A BLACK RAL 9005 POWDERCOATED FINISH.
 - MINIMUM CLEARANCES FOR VENTILATION & SERVICE AROUND THE UPS CABINET ARE REQUIRED.

	<small>DRAWN</small> AA 17.04.14	<small>SCALE</small> NTS	<small>FILENAME:</small>	A4
	<small>TITLE</small> GENERAL ARRANGEMENT 93E 300-400kW +LL-BAT (RIGHT)			
	<small>DRAWING NUMBER</small> A4GA0036			<small>REV</small> 0

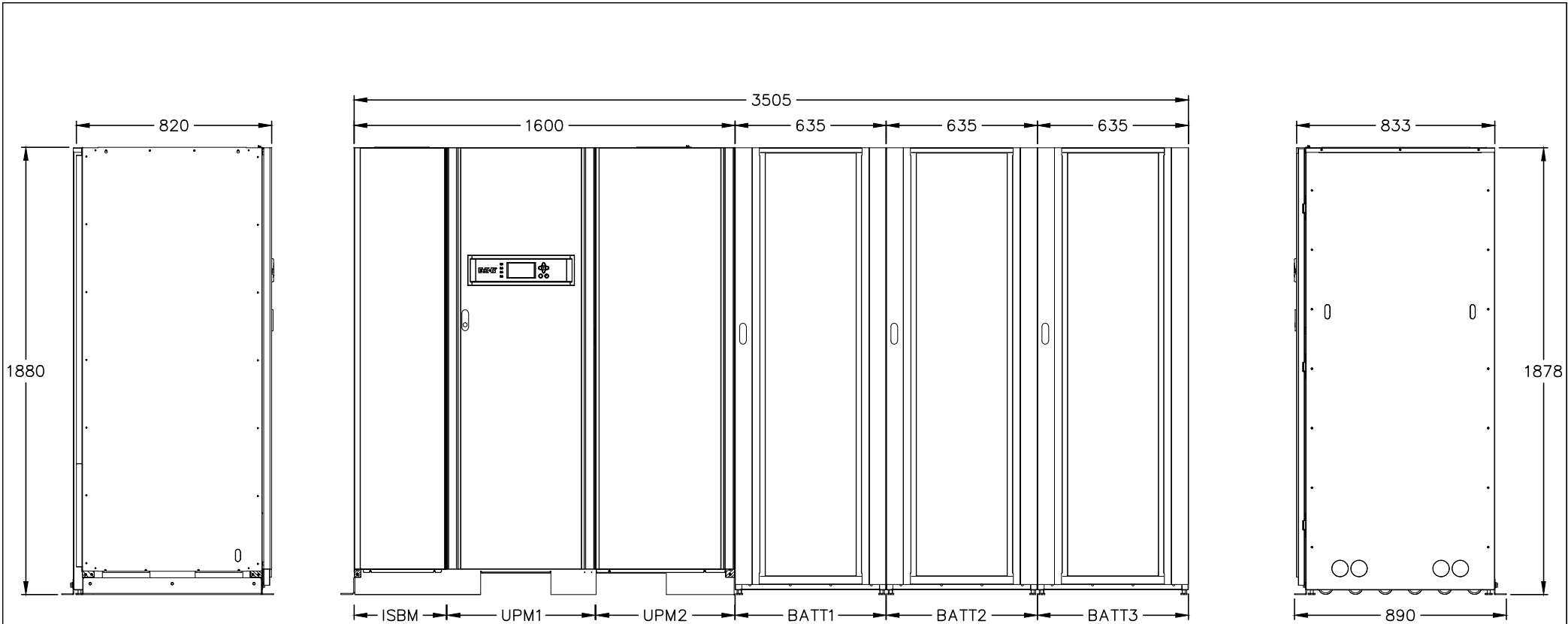

LEFT SIDE VIEW

FRONT VIEW

RIGHT SIDE VIEW

BATTERY				
PART NUMBER	93EEBCI150C40XXX	93EEBCI200C40XXX	93EEBCI280C40XXX	93EEBCI320D40XXX
RATING (PER CELL)	150kg	200kg	280kg	320kg
NUMBER OF CELLS	40	40	40	40
MASS	707kg	941kg	1269kg	1317kg

UPS		
PART NUMBER	93E300U-IB	93E400N-IB
RATING	300kVA	400kVA
MASS	970kg	970kg

- NOTES:
- UPS AND BATTERY CABINETS HAVE A BLACK RAL 9005 POWDERCOATED FINISH.
 - MINIMUM CLEARANCES FOR VENTILATION & SERVICE AROUND THE UPS CABINET ARE REQUIRED.

EATON	DRAWN AA	SCALE NTS	FILENAME:	A4
	17.04.14			
	TITLE GENERAL ARRANGEMENT 93E 300-400kW +3xL-BAT (RIGHT)			
AS-1100 THIRD ANGLE PROJECTION			DRAWING NUMBER A4GA0037	
UNLESS OTHERWISE SPECIFIED ALL DIMENSIONS IN MILLIMETRES.			REV 0	

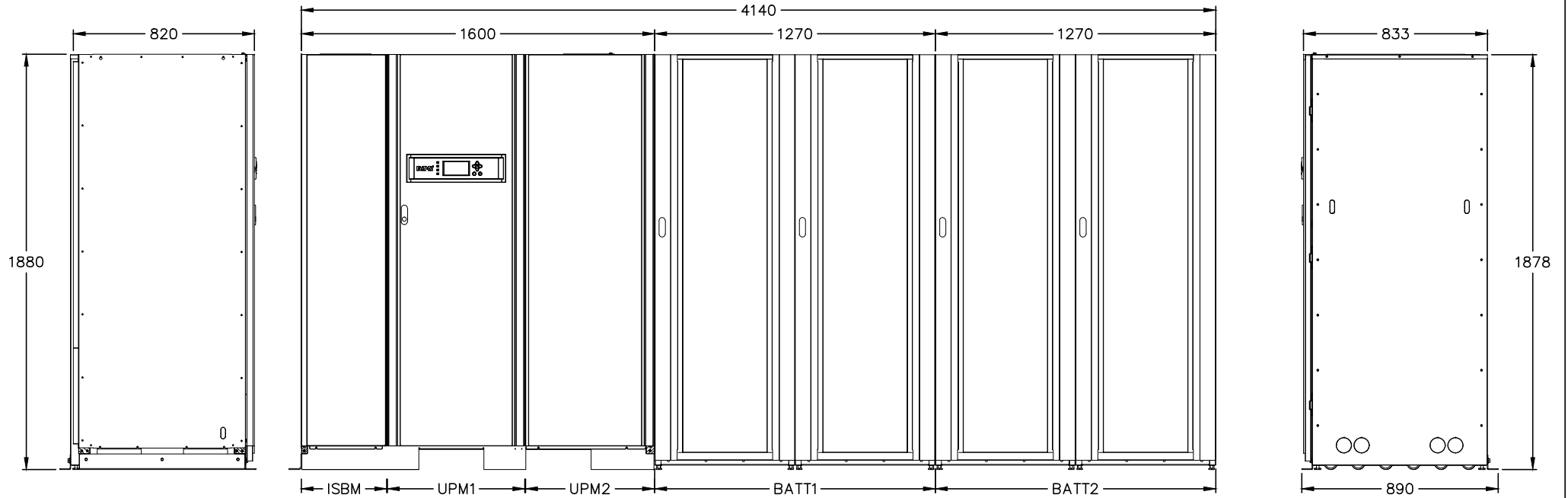

LEFT SIDE VIEW

FRONT VIEW

RIGHT SIDE VIEW

BATTERY			
PART NUMBER	93EEBCII390C40XXX	93EEBCII500C40XXX	93EEBCII620C40XXX
RATING (PER CELL)	390W	500W	620W
NUMBER OF CELLS	40	40	40
MASS	1765kg	2273kg	2333kg

UPS		
PART NUMBER	93E300U-IB	93E400N-IB
RATING	300kVA	400kVA
MASS	970kg	970kg

- NOTES:**
- UPS AND BATTERY CABINETS HAVE A BLACK RAL 9005 POWDERCOATED FINISH.
 - MINIMUM CLEARANCES FOR VENTILATION & SERVICE AROUND THE UPS CABINET ARE REQUIRED.

EATON	DRAWN AA	SCALE NTS	FILENAME:	A4
	17.04.14			
	TITLE GENERAL ARRANGEMENT 93E 300-400kW +2xLL-BAT (RIGHT)			
DRAWING NUMBER A4GA0038			REV 0	

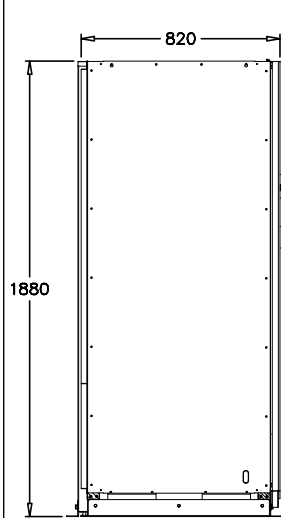

1880

820

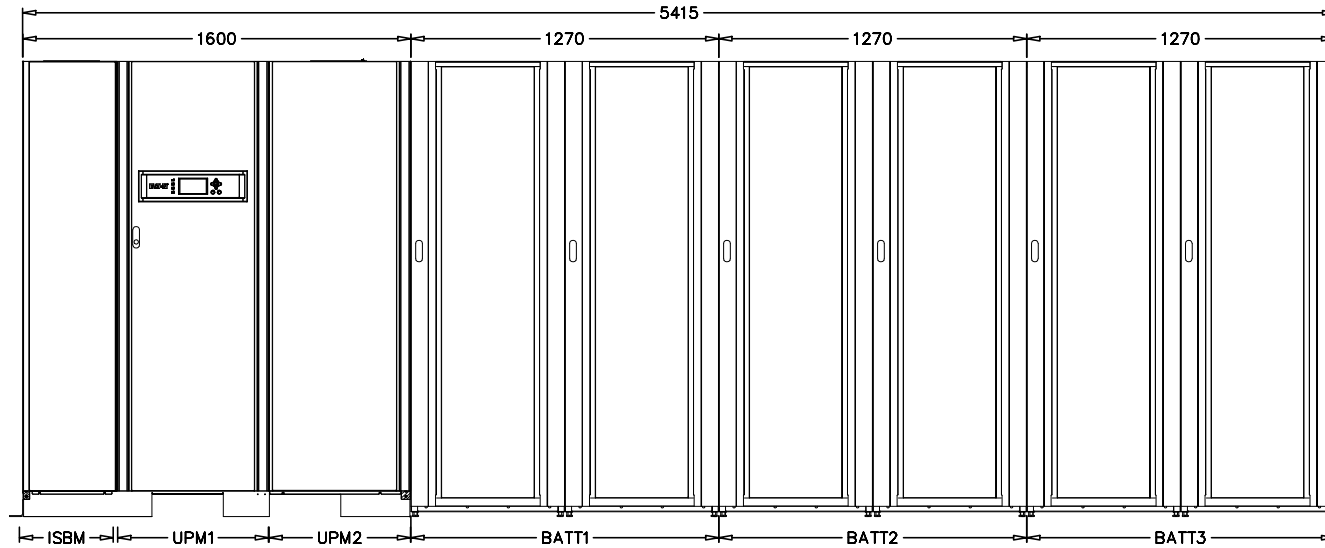

FRONT VIEW

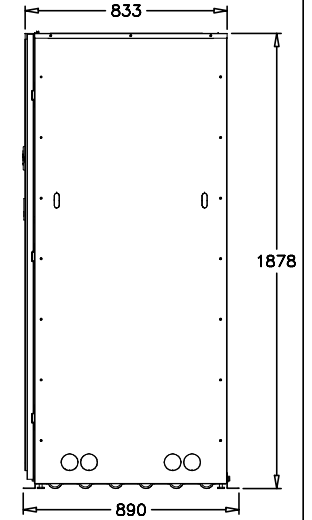

RIGHT SIDE VIEW

LEFT SIDE VIEW

BATTERY			
PART NUMBER	93EEBCII390C40XXX	93EEBCII500C40XXX	93EEBCII620C40XXX
RATING (PER CELL)	390W	500W	620W
NUMBER OF CELLS	40	40	40
MASS	1765kg	2273kg	2333kg

UPS		
PART NUMBER	93E300U-IB	93E400N-IB
RATING	300kVA	400kVA
MASS	970kg	970kg

- NOTES:**
- UPS AND BATTERY CABINETS HAVE A BLACK RAL 9005 POWDERCOATED FINISH.
 - MINIMUM CLEARANCES FOR VENTILATION & SERVICE AROUND THE UPS CABINET ARE REQUIRED.

	<small>DRAWN</small> AA 17.04.14	<small>SCALE</small> NTS	<small>FILENAME:</small>	A4
	<small>TITLE</small> GENERAL ARRANGEMENT 93E 300-400kW + 3xLL-BAT (RIGHT)			
	<small>DRAWING NUMBER</small> A4GA0039			<small>REV</small> 0

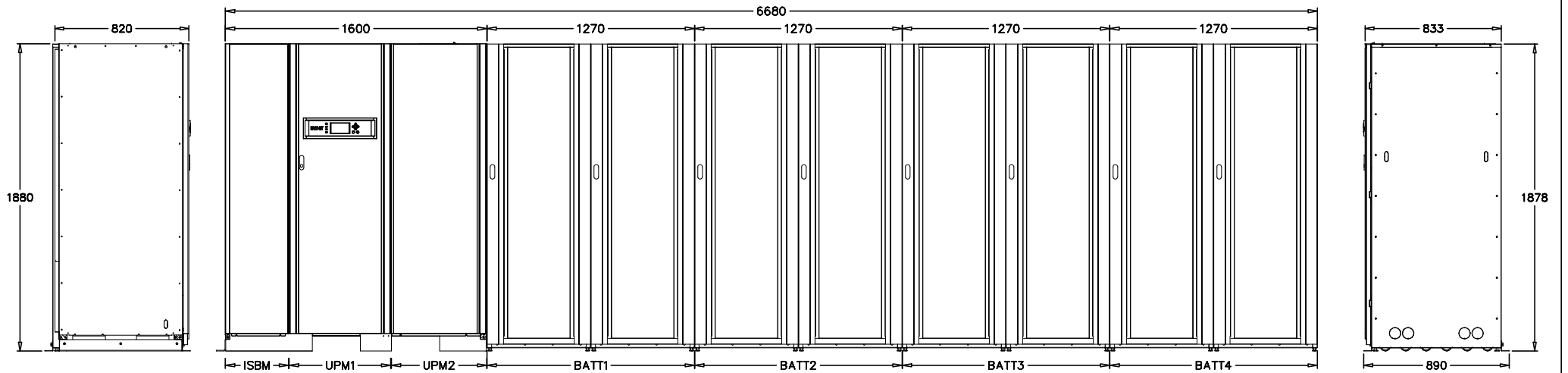

LEFT SIDE VIEW

FRONT VIEW

RIGHT SIDE VIEW

BATTERY			
PART NUMBER	93EEBCII390C40XXX	93EEBCII500C40XXX	93EEBCII620C40XXX
RATING (PER CELL)	390W	500W	620W
NUMBER OF CELLS	40	40	40
MASS	1765kg	2273kg	2333kg

UPS		
PART NUMBER	93E300U-IB	93E400N-IB
RATING	300kVA	400kVA
MASS	970kg	970kg

- NOTES:**
- UPS AND BATTERY CABINETS HAVE A BLACK RAL 9005 POWDERCOATED FINISH.
 - MINIMUM CLEARANCES FOR VENTILATION & SERVICE AROUND THE UPS CABINET ARE REQUIRED.

 <small>AS-1100 THIRD ANGLE PROJECTION</small>	<small>DRAWN</small> AA 17.04.14	<small>SCALE</small> NTS	<small>FILENAME:</small>	A4
	<small>TITLE</small> GENERAL ARRANGEMENT 93E 300-400kW + 4xLL-BAT (RIGHT)			
	<small>DRAWING NUMBER</small> A4GA0040			<small>REV</small> 0