

10% more power.
18% less heat.

The new and improved Power Xpert 9395P



EATON

Powering Business Worldwide

Improving on excellence

The Power Xpert 9395P builds on the success and track record of the Power Xpert 9395. It provides the benefits of high double conversion efficiency and greater power density, gained from the most recent technological developments in power management. And of course it's designed and built to the same high quality standards as all our 3-phase UPS products, and sold with the excellent level of customer support you expect.

Thinking ahead

Rapid adoption of the cloud, constant evolution of IT technologies, and an increasing focus on reducing the environmental footprint of mission critical infrastructure, means demand is growing for even more efficient, resilient, scalable and smart power chain solutions. Meanwhile, the rapid evolution of mission critical infrastructure such as data centres – requiring unprecedented availability with tightly controlled costs – continually pushes at the boundaries of technology.





50 years of UPS leadership

Eaton's long history of UPS expertise encompasses Web 2.0, multi-tenant, medium and large enterprise data centres as well as industrial applications, so we have a deep understanding of our customers' needs.

Innovation is also integral to our heritage, with patented systems such as Best Power, Powerware, MGE Office Protection Systems, and B-Line. In fact, we have led the way in UPS innovation for 50 years – bringing our customers new, more advanced, more efficient and more reliable power supply solutions.

The 9395P UPS represents the latest in our long line of market-leading, technologically advanced UPSs for mission-critical applications.

Meeting your needs

The 9395P has been developed to meet your current and future needs for efficiency, resilience, scalability and much more. It not only provides market-leading efficiency across operational modes, but also an enhanced modular design to support scalability and minimise MTTR. And its design and technology is well proven in our global installed base of more than 5 GVA. The result? A greatly reduced Total Cost of Ownership.

100% quality and beyond...

The 9395P – like all our 3-phase UPS products – is manufactured in our manufacturing site in Finland. Opened over 50 years ago, the factory has delivered more than 250,000 UPS units to date. The site in Finland also hosts Eaton's large UPS centre of competence, which hosts more than 500 visitors a year for Factory Acceptance Tests (FATS) and demonstrations.



Innovation in action

Eaton's strength in innovation makes us the natural choice as leaders of GreenDataNet: a consortium of technology innovators and manufacturers, working to develop state-of-the-art technology which will allow urban data centres to balance rising demand with sustainable energy policies.

Other Green Data Net members are: the Swiss Federal Institute of Technology Lausanne, Nissan, ICTRoom, Credit Suisse, the French Alternative Energies and Atomic Energy Commission, and the University of Trento.

Your mission critical UPS

Whatever your mission critical application, the Power Xpert 9395P UPS offers the power performance, reliability and flexibility you need.

It is ideal for:

- large data centres
- large infrastructure projects
- finance and banking critical infrastructure
- large industrial complexes or other buildings
- healthcare
- process control equipment
- telecommunications installations



The 7,5GVA UPS

Launched in 2007, the reliability of the Power Xpert 9395 has been proven with installations totalling no less than 7,5GVA globally. Our UPS are installed in all the major datacentre hubs in Europe and around the world.

Now the new 9395P uses the experience gained from multiple installations for a huge variety of applications, to create a UPS that is even more:

efficient
resilient
SCALABLE
smart





7.50GVA

More protection, more choice

The addition of the Power Xpert 9395P to the Eaton UPS range means there is now an Eaton UPS to meet most large mission critical application requirements, with the highest possible energy efficiency.

The power rating of the 9395P is from 250 kVA to 1200 kVA. The rated real power of the 9395P can be delivered with 0,9 pf which means that the typical loads can be fed without oversizing the UPS.



Power rating

250- 1200 kVA

Can be paralalled up to 7 units

More flexibility

Eaton System Bypass Module (SBM)

In addition to its distributed bypass system design, the Eaton SBM provides extra flexibility and a range of alternatives for your system design, by supporting centralised multi-module paralleled 9395P systems.

Available in 2000 A, 2500 A, 3200 A, 4000 A and 5000 A ratings as standard, the SBM includes a continuous-duty centralised static switch, backfeed protection device and centralised bypass systems.

The future of power protection

The launch of the 9395 UPS in 2007 set a new standard in three-phase transformerless power protection technology. Now the Power Xpert 9395P brings you even more benefits, through our proven technologies and advanced features. So you can expect even better performance and a lower overall cost with proven high reliability.

Key improved highlights

- Efficiency
- Increased power density
- Enhanced modularity
- Adaptive fast transients algorithms



Maximised availability

The UPS is a vital element in ensuring the highest possible availability for a power distribution system. The Power Xpert 9395P provides a wide range of features in a proven design, to maximise power system availability. By taking full advantage of the features of the 9395P, customers can ensure availability of maximum secured power, to meet the requirements of even their most demanding mission-critical applications.

Simplicity and flexibility

A modular structure and tailored solutions can ensure the simplest possible configuration to meet the site-specific UPS power and redundancy requirements.

Distribution network compatibility

The design, tools and functions of the 9395P help to ensure its compatibility with the requirements of the surrounding power distribution network. Relevant features support protection selectivity, generator compatibility, and the capability to handle challenging motor and VFD loads.

Easy maintenance

The modular structure, HotSync technology and service disconnect feature of each power module mean that the 9395P can deliver conditioned power to loads, even during UPS maintenance.

Resiliency

From technology to mechanical and thermal design, the 9395P includes a number of features to ensure the highest possible resiliency for mission-critical systems.



Lower Total Cost of Ownership

The 9395P UPS costs you less to own because it's more efficient, thanks to a number of leading technologies – some of them unique to Eaton.

Leading Efficiency Technologies

Lower energy use

Losses and energy consumption are reduced, due to the extremely high level of double conversion efficiency (96.3%) provided by the 9395P. The 9395P completely isolates output power from all input power anomalies, and delivers 100% conditioned, perfect sine-wave output, even during severe power disturbance.

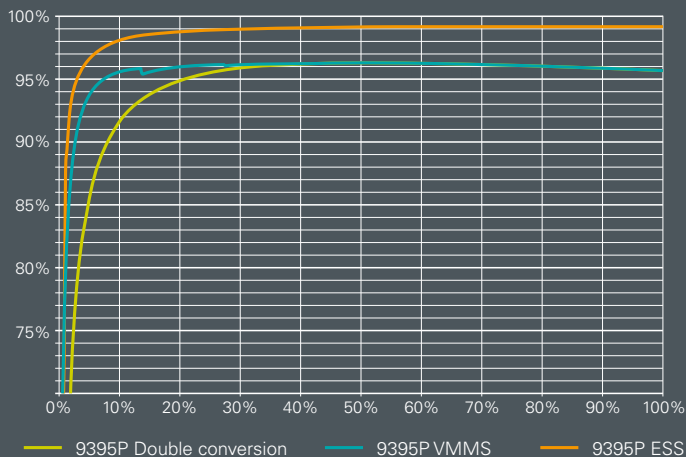

VMMS efficiency is based on system of 10 power modules

Optimised Double Conversion

Variable Module Management System (VMMS) helps you achieve high efficiency even when UPS load levels are low – typical for redundant UPS systems. VMMS can optimise the load levels of power modules in a single UPS or in parallel UPS systems, by suspending extra UPS capacity. This means not only greater efficiency at lower load levels, but optimum efficiency at all load levels, as illustrated below.

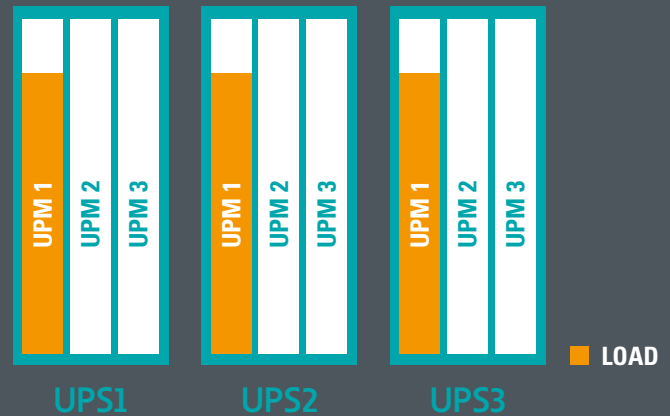

Ultimate savings

Energy Saver System (ESS) improves the 9395P efficiency levels to 99%, by suspending the power modules when power conditioning is not required. The power is fed through the static bypass switch, and the UPS is ready to switch to double-conversion mode in less than two milliseconds, in the event of exceeding pre-set input limits. In addition to extremely low losses, the ESS mode provides filtering against fast low-energy transients. It is simply the most advanced, most reliable, fastest-reacting energy-saver architecture available.

CO2 EMISSION
REDUCTION

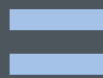

x80 
FLIGHTS AROUND THE
GLOBE PER PERSON

*1 x 9395P 1100 kW in ESS mode with 27% load level over 10 years compared to double conversion mode

VMMS and ESS are intelligent operation modes to optimise the UPS performance to match the load changes or power quality. Thanks to inherent load sharing the 9395P system is able to maintain the maximum load protection even with total loss of communication under varying load and power conditions.

Easy Capacity Test

Load testing can be costly and time consuming – but not with the 9395P. Its Easy Capacity Test feature recirculates energy from the UPS for testing. So there's no need to spend money renting load banks, and no time or energy wasted on temporary load connections.

Reduced footprint

By providing greater power density, the Power Xpert 9395P enables you to have more power from the same footprint. So now you can get the power you need while utilising the minimum amount of valuable space.

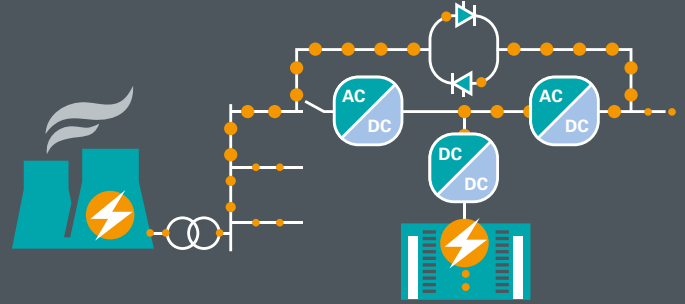

Reducing your total cost of ownership

Low operation costs and a fast return on your investment can now be achieved thanks to the latest developments in UPS hardware and the proven technologies built in to Power Xpert 9395P:

Double conversion efficiency

High energy efficiency in double conversion mode significantly lowers operation costs and provide savings in air cooling. Replacing an older generation UPS with a 9395P will be paid back in 2-3 years.

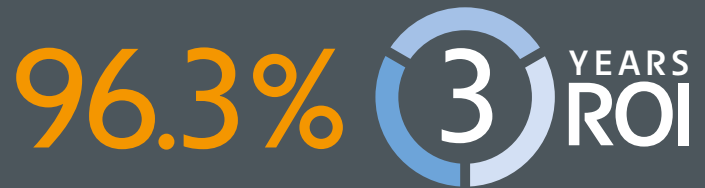

Energy Saver System

ESS is the most proven and reliable energy saving system on the market with many years of usage within a wide install base. When comparing to extremely high double conversion efficiency, ESS mode can still reduce the losses by 74% with a typical UPS load.



Easy Capacity Test

ECT makes on-site testing easier during commissioning and scheduled maintenance by eliminating the need for big and expensive load banks and testing related operational costs. By utilising ECT for on-site testing of a system of 6 units, it is possible to save the purchase price of one UPS.

ECT TESTING OF



What's in it for me?

Check Eaton's new TCO calculator
eaton.eu/TCO



Resiliency

Whatever the changing conditions – and however quickly they change – the Power Xpert 9395P is designed to maintain a steady, uninterrupted, clean power supply for you. This market-leading resiliency is the result of a number of advanced technologies built-in to the 9395P.

HotSync

A patented load-sharing technology for parallel operation of static converters, without communication or load-share signals. Because Power Xpert 9395P does not rely on a communication link, master control or synchronisation signals, it provides the highest possible reliability for load-sharing, by eliminating the risk of single point of failure in a parallel operating UPS system.

Maximum availability

The Power Xpert 9395P has one static switch per UPS. This concept enables full bypass capacity to be achieved on day one. Power modules can then be added as the loads increase. Having full bypass capacity available ensures selectivity and fault co-ordination also from day one.

Advanced Battery Management (ABM)

Extends the life of valve-regulated lead-acid batteries, through an intelligent charging routine. This prevents unnecessary charging and significantly retards the battery wear rate. ABM technology is a widely used and accepted technology with a 20-year proven track record.

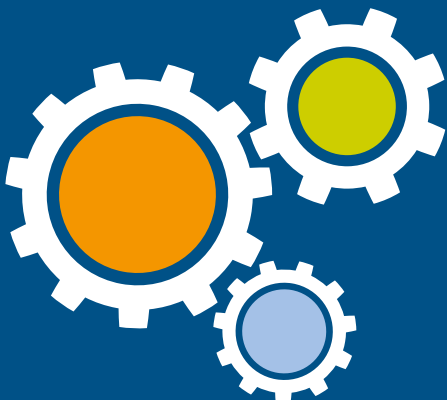

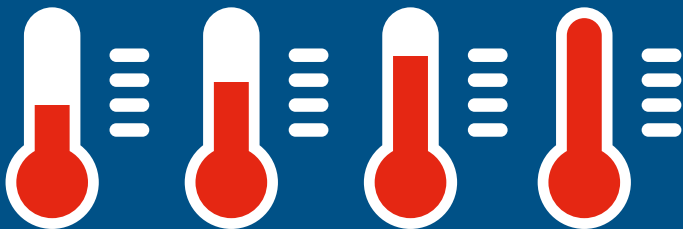

Performance in higher temperatures

The 9395P is designed for continuous operation at an ambient temperature of up to 40°C, without de-rating. It is also capable of delivering safe power in even higher temperatures, without shutting down. This allows high availability even in conditions other than standard room temperature. Producing 18% less heat during operation helps reduce the need for cooling.

Power factor preparedness

In some applications, such as industrial processes, the load power factor can change widely and rapidly. The wide power factor range of the 9395P means your UPS is capable of feeding the loads without de-rating, and your processes will not be affected.

Scalability

The Power Xpert 9395P range provides several options for scaling, and for tailoring the optimal fit for your application. UPS power scaling can be achieved by:

- increasing UPS capacity
- adding a new UPS in parallel to the existing installation, or
- adding a new UPS system and transferring the load to it.

HotSync technology and Eaton synchronisation accessories ensure scaling can be carried out reliably, regardless of the method used.

Scaling capacity

The modular design of the 9395P allows UPS capacity to be increased at any time, simply by adding power modules to the existing UPS. Capacity can be increased in steps of 250 or 300 kVA, whilst still providing full bypass capacity from day one.

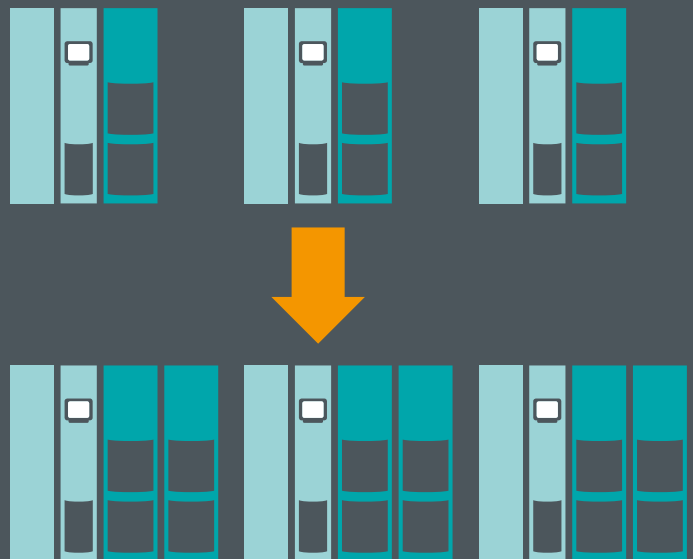

Matching fault current levels

The static bypass of the UPS can be sized separately, to match the fault current levels of the installation. This enables matching of the UPS to site requirements, without the need to invest in extra UPS capacity in case of high fault current levels. When higher fault current levels are present, Eaton SBM can provide large bypass capacity, thanks to the centralised bypass design.

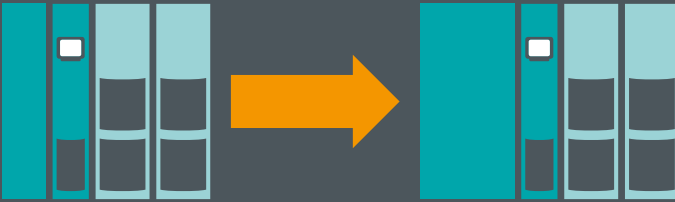

Synchronising systems

The Power Xpert 9395P platform offers a range of options for synchronisation with other brands or types of UPS (e.g. dual-fed STS loads), or for synchronising different systems with unsynchronised sources, to enable transfer of loads from one system to another. This provides greater flexibility for maintenance, and for scaling UPS power without compromising system reliability or customer Service Level Agreements.



Power protection made easier

The Power Xpert 9395P not only makes power protection more efficient, resilient and scalable, but also easier. Ease of installation and a large improved display maximise the ease both of management and deployment.

Ease of deployment

A spacious installation cabinet, with top- and bottom-entry for cables, makes the 9395P much faster and easier to install.

Ease of maintenance

Once installed, service and maintenance is also made easier without sacrificing availability. As long as the UPS has more than one power module, work can be carried out on an individual module while the UPS still supports load in double conversion mode. This is only possible because of the modular construction of the 9395P and safe and easy isolation of single power module.

Ease of management

A flat 7" or 10" touchscreen display on all 9395P units makes the UPS easier to monitor and control. More information can be displayed at any one time, with graphs and logs made easier to read.

Users can:

- view efficiency, load level, and daily consumption information at-a-glance
- spot trends using the daily, monthly and yearly load-profiling screens
- monitor battery usage in the improved battery log
- track time in ESS and VMMS using the new statistics screen

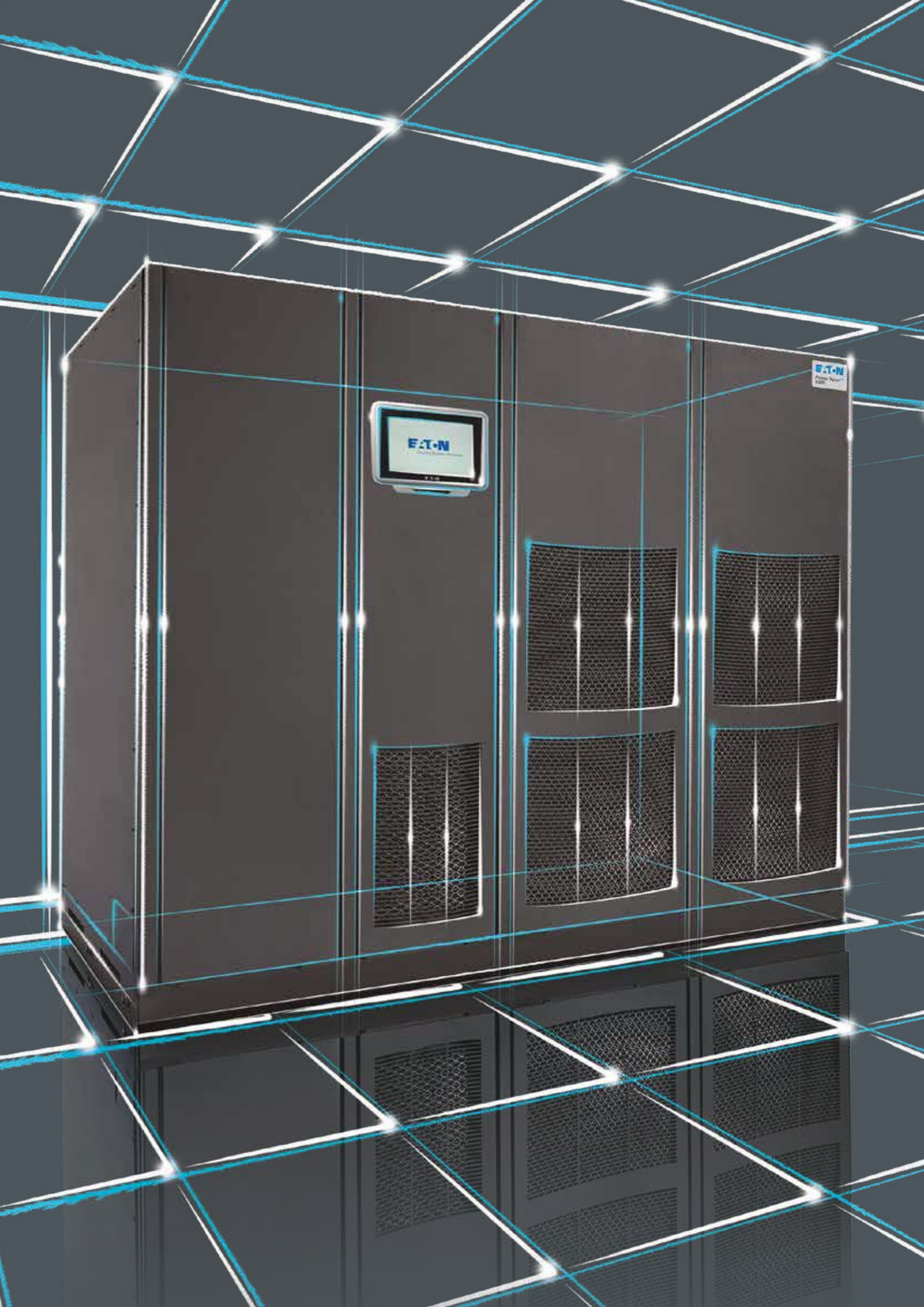



Quick and easy detection

Power module status lights allow the user to detect the system status with one look. The power module lights change colour depending upon their status. This optional feature makes the visual detection of the UPS system status easier, increasing operational safety and reducing the time required for trouble shooting.

9395P in Double conversion mode

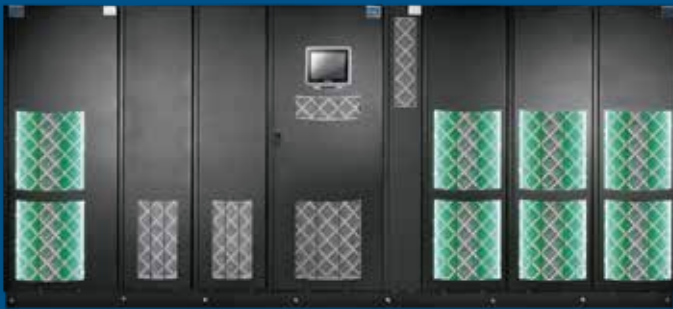

9395P on batteries

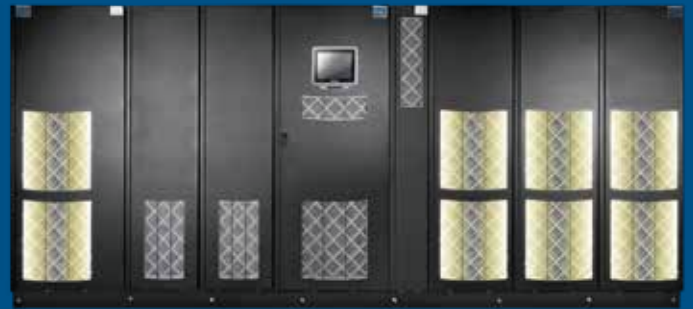

9395P in VMMS mode

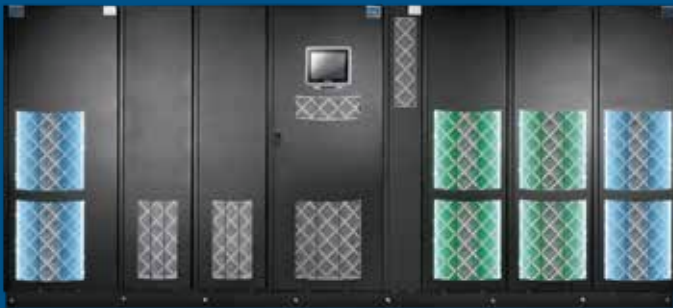

Double conversion mode with UPM alarm



9395P in ESS mode





At your service everywhere

With three Power Quality manufacturing facilities in the EMEA region, plus a strong local service presence, Eaton will provide your UPS with expert support from day one to the end of its service life.

Peace of mind

Eaton has a service team on call 24/7, so risks can be minimised through early detection of problems and timely action, before disturbances or downtime result.

There are over 120 Eaton field engineers operating across EMEA – all comprehensively trained and continually updated on the latest products and technologies.

The dedicated support package they provide will ensure your equipment runs safely, reliably, sustainably and with the utmost energy efficiency, at all times.

The proof is in the testing

The quality and reliability of the Power Xpert 9395P is not something you have to wait to experience. Eaton's 5 MW state-of-the-art testing facilities in Finland allow you to conduct standard and customised tests to meet your specific needs, and to address your "what if" scenarios.

Expert specialist support

The specialist Eaton 3-phase Solutions team offers tailored solutions and support for customers with large power supply needs – such as data centres – or who operate in industries with specific requirements, such as marine or offshore.

The service extends from planning to manufacturing, and from onsite testing to commissioning.

Technical specifications

UPS output power rating								
kVA	250	300	500	600	750	900	1000	1200
kW	250	275	500	550	750	825	1000	1100

General	
Efficiency in double conversion mode (full load)	95.6%
Efficiency in double conversion mode (half load)	96.3%
VMMS (double conversion)	Significantly increased efficiency at low loads
Efficiency in Energy Saver System (ESS)	Up to 99.3%
Distributed parallelling with Hot Sync technology	Up to 7
Internal N+1 redundance capable	In 600 kVA: 300 kVA In 900 kVA: 600 kVA In 1200 kVA: 900 kVA
Field upgradable	Yes
Inverter/rectifier topology	Transformer-free IGBT with PWM
Audible noise	78 dB (300 kVA); <81 dB (600 kVA); <83 dB (900 kVA); <85 dB (1200 kVA)
Altitude (max)	1000 m without derating (max 2000 m)

Input	
Input wiring	3 ph + N + PE
Nominal voltage rating (configurable)	220/380, 230/400, 240/415 V 50/60 Hz
Input voltage range	+15% / -15% for 400 V or 415 V +15% / -10% for 380 V +10% / -10% for bypass
Input frequency range	45-65 Hz
Input power factor	0.99
Input ITHD	<3% on nominal load in double conversion mode
Soft start capability	Yes
Internal backfeed protection	Yes, standard

Output	
Output wiring	3 ph + N + PE
Nominal voltage rating (configurable)	220/380, 230/400, 240/415 V 50/60 Hz
Output UTHD	<2% (100% linear load), <5% (non linear load)
Output power factor	0.9 (300, 600, 900 and 1200 kVA models) 1.0 (250, 500, 750 and 1000 kVA models)
Permitted load power factor	0.7 lagging - 0.8 leading
Overload on inverter	10 min 100-110%; 30 sec 110-125%; 10 sec 125-150%; 300 ms >150%
Overload when bypass available	Continuous <115%, 20 ms 1000% Note! Bypass fuses may limit the overload capability

Battery				
Type	VRLA, AGM, Gel, Wet Cell			
Charging method	Current limited constant voltage charging, or Eaton Advanced Battery Management (ABM)			
Temperature compensation	Optional			
Battery nominal voltage (lead-acid)	480 V (40 x 12 V, 240 cells)			
Charging current / Model	300	600	900	1200
Max* A	120	240	360	480

*Limited by maximum UPS input current rating

Dimensions and weights		
300 kVA	1350 x 880 x 1880 mm (wxdxh)	830 kg
600 kVA	1890 x 880 x 1880 mm	1440 kg
900 kVA	3710 x 880 x 1880 mm	2680 kg
1200 kVA	4450 x 880 x 1880 mm	3120 kg

Accessories	
	External battery cabinets with long-life batteries, X-Slot connectivity (Web/SNMP, ModBus/Jbus, Relay, Hot Sync, ViewUPS-X remote display), integrated manual bypass for 300 kVA model

Communications	
X-Slot	4 communication bays
Relay inputs/outputs	5/1 programmable

Compliance with standards	
Safety (CB certified)	IEC 62040-1
EMC	IEC 62040-2
Performance	IEC 62040-3



The future of power protection starts here

The Power Xpert 9395P UPS gives you a glimpse into the future of power protection. To see more of the future, visit www.eaton.eu/9395P now.