

Differences and similarities between ANSI and IEC cultures for MV assemblies—the Brazilian experience

Luiz Felipe O. Costa
Senior Member, IEEE
Eaton

Estellito Rangel Jr.
Senior Member, IEEE
Petrobras

José M. de Carvalho Fo.
D.Sc.- E.E.
UNIFEI - GEQEE

Rogério C. Barros
Member, IEEE
Eaton

Copyright 2013 IEEE.
Personal use of this material is permitted. Permission from IEEE must be obtained for all other uses, in any current or future media, including reprinting/republishing this material for advertising or promotional purposes, creating new collective works, for resale or redistribution to servers or lists, or reuse of any copyrighted component of this work in other works.

Digital Object Identifier: 10.1109/PCICon.2013.6666014

Abstract

The Brazilian petroleum and chemical industry has used MV power assemblies based on ANSI/NEMA® for many years. However, in the last three decades, due to the Brazilian Standards Association's orientation, users and manufacturers have been changing their philosophies to the IEC culture.

Because of both the increasing opportunity and the need for medium voltage electrical power distribution in petrochemical facilities, there is an opportunity to adopt MV switchgear or controlgear design based on ANSI or IEC standards, according to each plant's specifications. Although the use and design of MV assemblies are based on the electric power system's needs and characteristics, they are also a compromise with the current scenario and experience of a specific petrochemical facility. Because both ANSI and IEC universes have strong experiences, knowledge, and huge safety concerns in electrical equipment design and applications, the final choice is interesting.

It is important to keep in mind that MV assemblies have to face key technical and safety issues because they are connected to an industrial power system, and both ANSI and IEC deal with such requirements very carefully. This paper deals with impacting topics related to MV switchgear and controlgear such as:

- ANSI and IEC requirements
- Rated values and characteristics
- Ancillary and power equipment applications
- Safety
- Ergonomics

Introduction

In the Brazilian electrical sector, the 20th century saw a mix of influences from North America (U.S. and Canada) and Europe (mainly Germany, England, France, and Italy). The petrochemical segment and electrical power distribution industry were driven primarily by ANSI and NEMA. In fact, when the Brazilian government decided that it needed to unify all frequency values in the country, the adopted value was 60 Hz, even with strong impacts in generation and distribution sectors of very important areas, such as the state of Rio de Janeiro, where the main utility company's system had 50 Hz as its rated frequency. The decade of the 1960s was a challenging time for Brazilian electrical engineers and technicians.

Another key milestone in Brazilian electrical history was the government's decision to embrace the adoption of ISO/IEC standards and guidelines for the national technical universe. This decision drove ABNT (Associação Brasileira de Normas Técnicas) to adopt IEC standards as the main reference for Brazilian Technical Standards (such changing movements increased by the end of the 1970s—an example of this important change at that time was the adoption of squared millimeter values to substitute AWG/MCM scales for copper wires and cables). Since then, other changes have occurred in our electro-technical culture. In the last two decades, all related switchgear and controlgear standards moved closed to the IEC culture (there were situations where the related technical committees decided to translate the original IEC standards—significant examples are related to LV and HV switchgear and controlgear families). An electric installation itself and its distribution and control equipment are classified primarily by their rated voltages. In the IEC culture, we have the so-called low and high voltage ranges. Also, according to the IEC, the threshold between the two ranges in AC installations is 1000V (rms value). However, it is normal in the ANSI universe of electrical distribution companies and several industry segments to refer to electric power installations and equipment for voltages up to 38 kV as "MV" (medium voltage) systems. We will keep our discussion and analysis for applications between 2.4 and 34.5 kV.

The Brazilian electrical culture considers AC (60 Hz) voltages values to be from 1 to 38 kV (rms values) as in the medium voltage (MV) range, due to our strong ANSI heritage in the electrical power distribution and petrochemical sectors.



Powering Business Worldwide

Within this context, switchgear and controlgear assemblies, such as motor control centers (MCC) and power distribution centers (PDC), have been used to supply, distribute, and control MV electrical power.

Most of the time, these assemblies are installed in locations where special requirements or conditions can be found, and all related phases of equipment lifetime demand careful attention.

As is known, a failure in an assembly results in multiple disorders and considerable costs. Because of this, a strong knowledge of switchgear and controlgear assemblies increases the probability of safeguarding the installations and personnel. Therefore, it is necessary to provide clear guidelines and powerful tools for the professionals in charge of specifying and/or dealing with switchgear and controlgear assemblies.

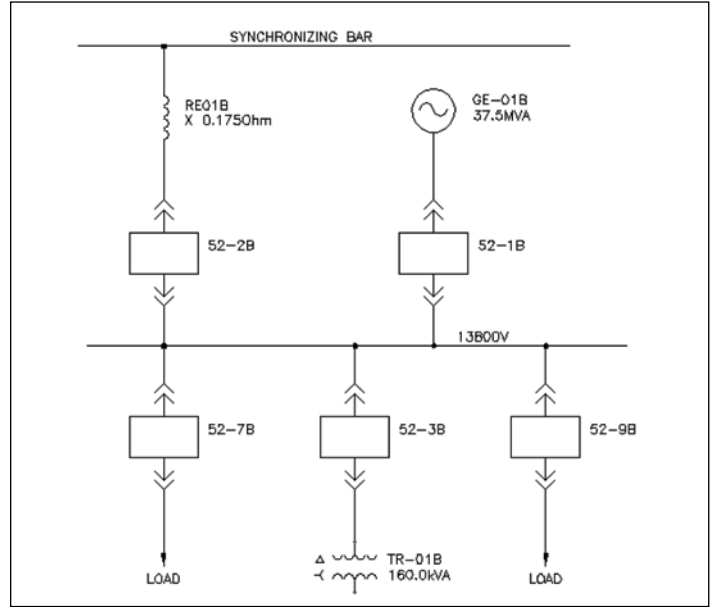

Figure 3. Part of a Single-Line Diagram of a Petrochemical Unit



Figure 1. Example of an ANSI/NEMA Assembly



Figure 4. MV Switchgear Assembly Corresponding to the Single-Line Diagram Shown in Figure 3



Figure 2. Example of an IEC Assembly

Analysis and discussion

Following the aforementioned scenarios, we need to keep in mind that all electrical power in an MV industrial installation should be:

- Operated
- Protected
- Controlled
- Regulated
- Measured

Such situations can be achieved directly by MV switchgear and controlgear assemblies with associated components, enclosures, interconnections, and accessories. Always take into account a safe operation and the condition of the electrical system and equipment, and keep in mind that the highest priority is always the person.

Independently of which philosophy is adopted, an MV interrupter unit will incorporate some basic components inside the compartments of a metal-enclosed column such as the power circuit breaker, CTs, protective relays, busbars, and so on.

It is possible to define the main compartments and parts of an MV metal-enclosed air-insulated indoor assembly (see **Figure 5** and **Figure 8**). They are:

1. LV compartment (control)
2. Dynamic flaps (overpressure relief)
3. Main busbar compartment
4. Interrupting device (MVCB) compartment
5. Withdrawable circuit breaker
6. Current transformers (CTs)
7. Power cables compartment
8. Earthing switching (grounding device)
9. Automatic shutters

Because all concerned physical and chemical phenomena are the key bases for any technical approach, no matter which standard is adopted, we must understand the real needs of the customers and their installations.

Our analysis will focus on the following topics.

ANSI/IEEE C37.20.2

In its scope, the standard ANSI/IEEE® C37.20.2 [1] establishes its aim to cover metal-clad (MC) switchgear and its devices and equipment. This standard is concerned with enclosed, indoor, and outdoor switchgear assemblies rated more than 1000 Vac. This document is normally adopted in the U.S.

This standard has certain unique requirements, such as insulated busbars and connections, withdrawable main switching devices, and minimum thickness for covers, barriers, panels, doors, and so on.

During the last three decades, we saw an increased use of two-high (double-tier) configurations for metal-enclosed column construction. This approach has proven its effectiveness. Its appeal is so strong that the main MV metal-clad switchgear manufacturers in the U.S. have this type of structure in their portfolios.

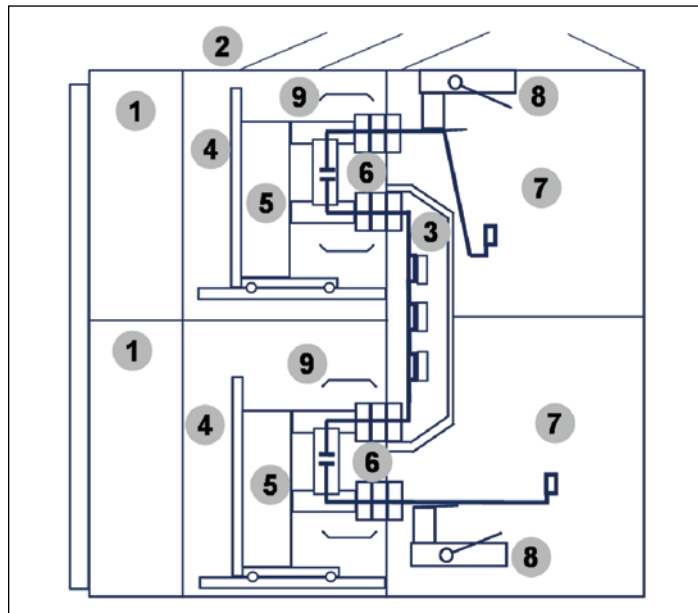

Figure 5. Two-High (Double-Tier) ANSI MV Assembly

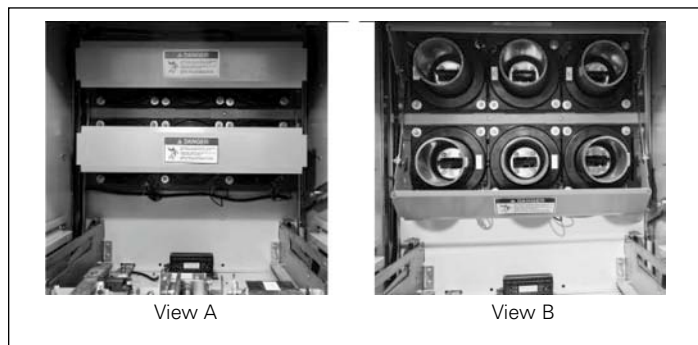

Figure 6. Typical ANSI Metal-Clad Compartment for Circuit Breaker. View A: Metallic Shutters Closed. View B: Shutters Open, Showing the Spouts' Power Connections and LV Ring Type CT (Mounted over the Bushings)

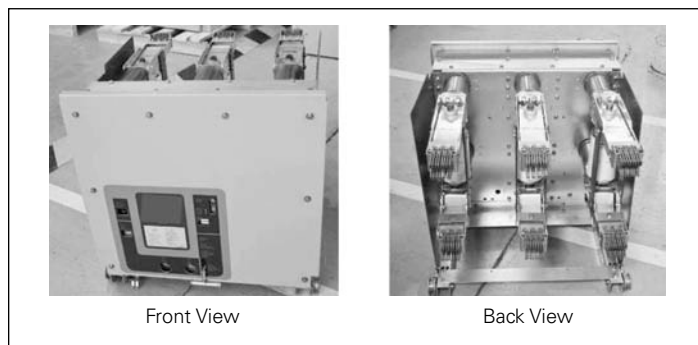

Figure 7. Front and Back Views of a Typical ANSI MV Vacuum Circuit Breaker

IEC 62271-200

The IEC 62271-200 [2] standard establishes the requirements for factory-assembled switchgear and controlgear assemblies with an externally grounded metal enclosure for AC systems (50 or 60 Hz) with operating voltages in the MV range (above 1 kV and up to and including 52 kV). This is an international standard that is normally used in Europe and also as a reference in several countries around the world.

In order to work with this standard, it is necessary to reference the document IEC 62271-1 [3].

Depending on the application, it will also be necessary to consult other IEC standards such as:

- IEC62271-100 (high voltage AC circuit breakers) [4]
- IEC62271-102 (high voltage AC disconnectors and earthing switches) [5]
- IEC62271-106 (high voltage AC contactors) [6]
- IEC60529 (IP degrees provided by enclosures) [7]
- IEC60044-1 (instrument transformers—CTs) [8]
- IEC60044-2 (instrument transformers—inductive VTs) [9]
- IEC60282 (high voltage CL fuses) [10]

Today, the more common constructing approach in the IEC universe is the so-called “mid-high” (single-tier) configuration for metal-enclosed column constructions. It is an evolution of the classic European design with one roll-on circuit breaker per column. Such evolution was based on the idea of front access for cable connections, making it possible to mount a line up with its back side close to a wall in order to reduce the area necessary for equipment erection.

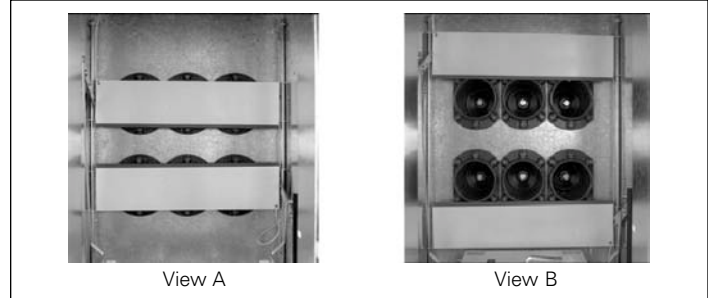

Figure 9. Typical IEC Metal-Enclosed Compartment for Circuit Breaker. View A: Shutters Closed. View B: Shutters Open, Showing the Spouts' Power Connections



Figure 10. Front and Back Views of a Typical IEC MV Vacuum Circuit Breaker

ABNT NBR IEC 62271-200

The current Brazilian standard ABNT NBR IEC 62271-200 [11] for MV metal-enclosed switchgear and controlgear is based strongly on the original IEC document. Because of this, the ABNT reference code uses the original IEC number that deals with metal-enclosed assemblies for voltages above 1 kV and up to and including 52 kV. It replaces the old NBR 6979 standard [12], which already included many IEC features in its text.

Basic required characteristics of MV switchgear and controlgear assemblies

The use and application of MV metal-enclosed assemblies are driven by the following characteristics, described in the aforementioned standards:

- Rated voltage
- Rated insulation level (lightning impulse and power frequency withstand voltages)
- Rated frequency
- Rated current
- Rated short-time withstand current
- Peak withstand current
- Duration of short-circuit
- Internal components rated values
- Fluid level and/or pressure

In order to help to understand the way that the Brazilian petrochemical industry has dealt with the transition from one standard's approach to another, it will be helpful to analyze each of topics mentioned above.

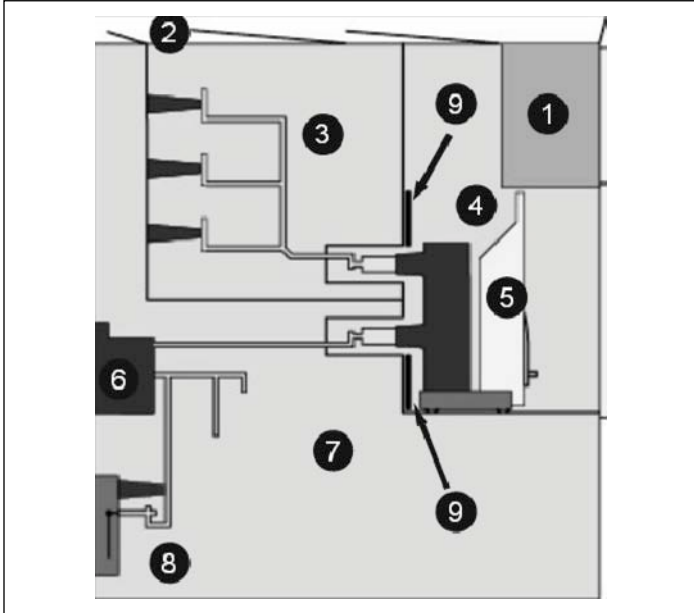

Figure 8. Typical Mid-High (Single-Tier) IEC MV Assembly

Rated voltage (U_r)

Because of ANSI/NEMA influence, the most common operating voltage (U_o) values adopted at MV levels in the Brazilian oil and gas segments are 4.15 and 13.8 kV. Other than these values, it is possible to find other common NEMA values: 2.4 and 34.5 kV. The former has been abandoned in new industrial applications, while the latter has increased its presence recently. It is also possible to find operating voltage values like e.e and 6.6 kV, but they are uncommon and would only be found in very few applications in the petrochemical segment in Brazil.

Table 1. Rated Voltage and Insulation Levels

BR	ANSI/NEMA			IEC		
	②	②	②	③	③	③
U_o [kV] ④	U_r [kV] ⑤	U_d [kV] ⑥	U_p [kV] ⑦	U_r [kV] ⑤	U_d [kV] ⑥	U_p [kV] ⑦
[2.4]	4.76	19	60	3.6	10	40
[3.3]	4.76	19	60	3.6	10	40
4.16	4.76	19	60	7.2	20	60
[6.6]	8.25	36	95	7.2	20	60
[11.0]	15	36	95	12.0	28	75
13.8	15	36	95	17.5	38	95
[23.0]	27	60	125	24.0	50	125
34.5	38	80	150	36.0	70	170

- ① Column 1: normal operating voltages in Brazil. The values in brackets are uncommon in the petrochemical sector.
- ② Columns 2/3/4: related to ANSI (IEEE Std 20.2-1999—Table 1) and also to IEC 62271-1—Table 1b.
- ③ Columns 5/6/7: related to IEC 62271-1—Table 1a.
- ④ U_o : operating voltage (kV—rms value).
- ⑤ U_r : rated voltage (kV—rms value).
- ⑥ U_d : rated power frequency withstand voltage (kV—rms value).
- ⑦ U_p : rated lightning impulse withstand voltage—BIL (kV—peak value).

The current Brazilian practice is to associate the 4.16 and 13.8 kV values to the rated voltages (U_r) of 7.2 and 17.5 kV from Table 1a from IEC 62271-1: 2007: “rated insulation levels for rated voltages of range I, series I (rms value for rated voltage— U_r).” Such choice, without the knowledge of the entire Brazilian electrical sector, is not considered to be the best, because the same standard offers another list with values closer to ANSI/NEMA culture (Table 1b). However, in this case, it was more of a political decision based on a rational technical reason: the federal government’s orientation to embrace the International System of Units (SI) in 1962 (reinforced by a government decision of 1988) and the widespread participation in several segments of the Brazilian economy of important companies with IEC-based knowledge.

Rated insulation level (U_d/U_p)

Keeping the analysis of 4.16 and 13.8 kV values as operating voltages, it is evident that the required values of 20 and 38 kV, as power frequency withstand voltages (for rated voltages of 7.2 and 17.5 kV, respectively) did not have any significant impacts. These new values are very close to the old required values of 19 and 36 kV for power frequency withstand voltages (ANSI/NEMA practice). The rated lightning impulse withstand voltage (U_p) values are the same for both cultures (ANSI and IEC): 60 and 95 kV (peak values).

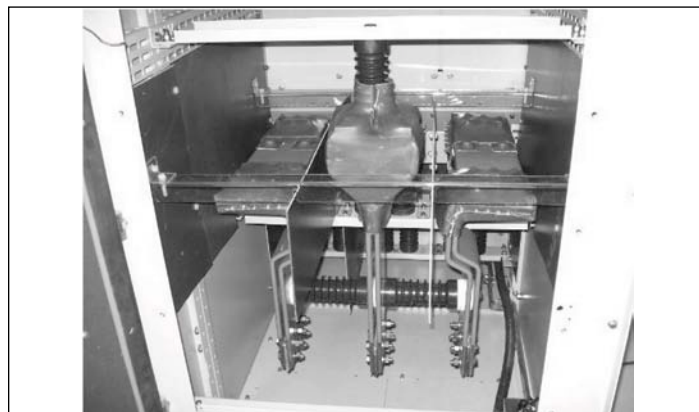

Figure 11. Internal MV Switchgear Configuration Tested for 95 kV BIL (See Oscillograms on Figure 12)

The procedural differences regarding the test verification of lightning impulse (BIL—Basic Impulse Level) caused some confusion in the beginning stages of the change from ANSI to IEC. Although the standard waveform criteria ($1.2 \times 50 \mu s$ full wave) are the same for both cultures, the differences in the number of positive and negative wave applications created some confusion. The “15 x 2” test procedure (15 applications with a maximum of two flashovers in self-restoring isolation parts) for each polarity (discharge probability of 13.3%) is more demanding when compared to the old ANSI practice for BIL verification of “3 x 1 x 3” (total of six applications with one flashover in the first three) for each polarity (probability of 16.7%). The first movement of end users and some consulting engineers was to ask for a new BIL test in the case of equipment based on the old ANSI requirement. When ANSI adopted the new and more demanding acceptance criteria of the “3 x 1 x 9” test (one flashover in the first three demands nine more shots, for a total of 12 applications—8.3% probability), such retest requirements were finally abandoned.

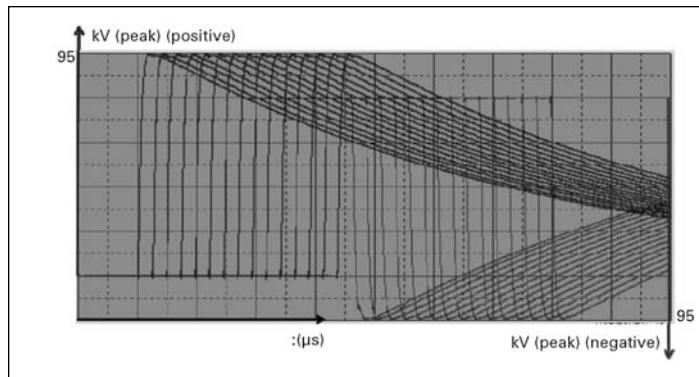

Figure 12. Oscillograms of 15 Positive and 15 Negative Voltage Wave Applications of Lightning Impulses

Rated frequency (f_r)

The current adopted rated frequency value in Brazil is 60 Hz. Although this is the standard value for the ANSI/NEMA universe, this is also an IEC recognized value.

Rated normal current (I_r) and temperature rise

The difference between ANSI values (1200/2000/3000A) and IEC values (1250/2000/3150A) is not significant. The adoption of multiples from R10 series, as specified in IEC 62271-1, -200, and 60059 [6], occurred immediately and without any significant impact.

Table 2. Typical Values for Rated Continuous Current

ANSI	IEC
①	②
A	A
	630
	800
1200	1250
	1600
2000	2000
	2500
3000	

① Column 1: continuous current ratings according to sub-section “5.4.2” from ANSI/IEEE Std 20.2-1999.
 ② Column 2: rated normal current (I_r) according to sub-section “4.4.1” from IEC 62271-200.

The R10 series (1/1.25/1.6/2/2.5/3.15/4/5/6.3/8) is part of a system of preferred numbers for use with the ISO metric system, proposed in 1870 by Charles Renard (1847–1905), a French military engineer.

One interesting occurrence during the transition from ANSI to IEC proposed values for rated current was that the higher temperature rise values for silver-coated connections promoted a comfortable perception by end users. This can be explained by the following equations relating the temperature rise to the current level:

$$\left(\frac{I_r}{I_e}\right)^2 = \left(\frac{\Delta\theta_r}{\Delta\theta_e}\right) \quad [1]$$

The indicated terms are:

- I_r: rated current value
- I_e: operating current value
- Δv_r: rated temperature rise
- Δv_e: operating temperature rise

As an example for this specific point, let’s see what could happen when the equation is applied to a 3150A current in a 3000A ANSI metal-clad busbar with silver-plated connections. Based on [1], the following relation applies:

$$\left(\frac{3000}{3150}\right)^2 = \left(\frac{65}{\Delta\theta_r}\right)$$

The result of this equation is approximately 72°C. It represents the temperature rise for a 3150A current applied to a 3000A ANSI switchgear. In other words, the equipment is able to accomplish the IEC requirement for a maximum temperature rise of 75°C (see **Table 3**) for a silver-coated connection.

In the case of the comparison of the 1200A used at the 1250A level, the value for temperature rise would be approximately 71°C. The same conditions are considered for the previously mentioned 3000A structure.

Table 3. Limits of Temperature Rise

①	ANSI		IEC	
	②	②	③	③
Bus Connection or Cable Termination	Temperature Rise °C	Total Temperature °C	Temperature Rise °C	Total Temperature °C
Bare copper	30	70	50	90
Tin-coated	65	105	65	105
Silver-coated	65	105	75	115
Nickel-coated	—	—	75	115
Cable to copper	30	70	50	90
Cable to tin	45	85	65	105
Cable to silver	45	85	65	105

① Column 1: types of bus or connection (bar-to-bar or bar-to-cable).
 ② Columns 2/3: temperature limits (rise and maximum total values) according to ANSI/IEEE Std 20.2-1999–Table 3.
 ③ Columns 4/5: temperature limits (rise and maximum total values) according to IEC 62271-1–Table 3.

Although the combination of hot and humid conditions with a sulfur rich environment on the copper (Cu—base metal) and silver (Ag—plating) elements used as contact surfaces in certain industrial atmospheres results in a well-known impact, it has not been a concern in the main petrochemical plants in Brazil. The well-known process of corrosion of Cu and Ag, under the conditions described above in refineries, petrochemical plants, paper and pulp facilities, steel mills, and wastewater unites has not been reported as a critical issue in the Brazilian oil and gas segments. It is possible that this is because there is a strong tendency to apply air conditioning units, filters, and pressurized systems in the main electrical rooms together with the criteria of installing the switchgears and controlgear assemblies as far away as possible from the main concentration of sulfur fumes (hydrogen sulfide). As clarification, the authors have already seen the requirement of using nickel (Ni) as plating material over copper in specific areas of steel mills and pulp and paper facilities in Brazil.

Rated short-time withstand current (I_k) and CB short-circuit interrupting capacity

The ANSI decision to adopt 1.0 as the rated value for the “K-factor” helped to reduce the doubts and confusions that were still noted among many Brazilian designers. Although the ANSI/NEMA philosophy had a strong influence in the Brazilian industry for several years, it was possible to see many doubts related to the use of K-factor, the relation between I_{sc} and system operational voltage, and MVA SC capacity concepts. It was common to see designers claiming that a “500 MVA” / 15 kV circuit breaker should be able to handle a 20.9 kA (symmetrical RMS) at 13.8 kV, based on the relation:

$$I_{SC} = \frac{MVA_{SC}}{\sqrt{3} \times U_e} \quad [2]$$

Here, the terms are:

- I_{sc}: short-circuit current (kA–rms value)
- MVA_{SC}: three-phase circuit breaker interrupting capacity (MVA)
- U_e: operating phase-to-phase voltage (kV)

This approach is incorrect; it is a misunderstanding of the old MVA classification for MV circuit breakers (such a circuit breaker is sometimes still referred to as a 500 MVA class, and this normally leads to an incorrect analysis). It is completely against the ANSI guidelines for such applications.

The Voltage Range Factor (K-factor) was established to take advantage of the characteristics of circuit breakers with interrupting technologies, such as oil and air, to increase their SC capacities as the system voltage decreases. However, with new technologies such as SF₆ and vacuum as interrupting medium, the specialists found that reducing the operating voltages would not improve the circuit breaker interrupting capacity.

According to [19], the Rated Voltage Range Factor (K) defines the voltage range where the value of the symmetrical interrupting current (rms value) varies inversely with the operating voltage at the point of circuit breaker application. Also, the rated symmetrical short-circuit current (Rated I_{SC}) is defined for the rated maximum voltage (U_r). So, the maximum symmetrical short-circuit current at the minimum operating voltage (minimum U_e) is given by:

$$Max_I_{SC} = Rated_I_{SC} \times K \quad [3]$$

Here, the terms are:

- Max_I_{SC}: maximum symmetrical short-circuit current capability at the minimum operating voltage (kA–rms value)
- Rated I_{SC}: rated symmetrical short-circuit current (kA–rms value)
- K: rated voltage range factor

In the cases where the values of K are greater than 1.0, the symmetrical interrupting capability between rated maximum voltage and 1/K times the rated maximum voltage is defined as:

$$I_{U_e} = Rated_I_{SC} \times \frac{U_r}{U_e} \quad [4]$$

Here, the terms are:

- I_{U_e}: symmetrical short-circuit current capability at operating voltage (kA–rms value)
- Rated I_{SC}: rated symmetrical short-circuit current (kA–rms value)
- U_r: rated maximum voltage (kV)
- U_e: operating voltage (kV)

According to [4], for a circuit breaker with a value of 18 kA for the rated symmetrical short-circuit current, at a rated maximum voltage of 15 kV, we, in fact, have 19.6 kA as the symmetrical SC, as seen below:

$$19.6kA = 18kA \times \left(\frac{15kV}{13.8kV} \right)$$

The use of a list based on the R10 series to choose the best value for the symmetrical short-circuit current in a context of maximum system voltage, which is in line with the new ANSI concept of “K-factor=1.0”, simplified the task for many professionals.

Table 4. Rated Short-Circuit Current for a 15 kV System

Short-Circuit Level	ANSI		IEC	
	②	③	④	⑤
MVA	kA rms	K-Factor	kA rms	K-Factor
500	18	1.3	20	1.0
500	18	1.3	25	1.0
750	28	1.3	31.5	1.0
1000	37	1.3	40	1.0
1000	37	1.3	50	1.0

- ① Column 1: although it has not been a standard practice for a long time, the MVA values are shown here as informative values to be used just as reference.
- ② Column 2: rated rms value for the symmetrical short-circuit current in the maximum voltage (15 kV).
- ③ Column 3: proposed K-factor for a range of current based on voltage limits (maximum and minimum values) for an inverse relation between SC current (symmetrical RMS value) and operating voltage.
- ④ Column 4: rms value for the symmetrical component of SC current, based on the IEC practice (R10 series).
- ⑤ Column 5: theoretical value for K-factor at the maximum voltage of 17.5 kV (in fact, current ANSI practice is k=1.0 for such level of voltage).

Rated peak withstand current (I_p)

The peak instantaneous value of the first half-cycle of the rated withstand current for an MV switchgear and controlgear assembly is based on the relation between itself and the effective value of the short-circuit symmetric component. Thanks to the harmonization process between ANSI and IEC for MV and HV circuit breakers, the current adopted value for X/R ratio is 17, that is the product of the time constant (π), 45 ms, and the angular speed (ω) of a system with frequency of 60 Hz, as follows:

$$\frac{X}{R} = \frac{\tau}{1000} \times \omega. \text{ Where: } \omega = 2\pi f$$

$$\frac{X}{R} = \frac{45}{1000} \times 2\pi \times 60 = 16.9646 \quad [5]$$

As already mentioned, this practice drives to the use of a value of 2.6 for the ratio of the peak current to its rms value for the first half-cycle of SC current (see IEC 60909 [14] for the mathematical relations among the X/R value, the effective value of symmetric component of SC current, I_k”, and the peak instantaneous value of the first half cycle, i_p). This approach allowed the designers to eliminate the old conflict between 2.5 (IEC proposed value) and 2.7 (old ANSI over conservative value), so there was no significant impact in terms of application and selection of MV gear:

$$i_p = k \times \sqrt{2} \times I_k'' . \text{ Where: } k = 1.02 + 0.98e^{-3R/X}$$

$$i_p = \left(1.02 + 0.98e^{\frac{-3}{17}} \right) \times \sqrt{2} \times I_k'' = 2.6042 \times I_k'' \quad [6]$$

Rated duration of short-circuit (t_k)

The decision of ANSI to reduce the rated value from 3 seconds to 2 seconds did not represent any impact in design criteria. In fact, the IEC value of 1 second had already been used for a long time. We could say that ANSI and NEMA's strong performance in this topic could represent a difference in some very specific cases.

Regarding the last two topics of our previous list of rated characteristics, we can say that there were no significant impacts in the way that the Brazilian oil and gas market sees the needs for critical items of MV switchgear.

Constructive designs and safety philosophies of MV switchgear assemblies

The main reasons behind the adoption of enclosures for MV switchgear assemblies are the provision of protection of:

- Persons against electric shock
- Persons against arc-flash risks related to the presence of incident energy
- Equipment against ingress of solid foreign objects
- Equipment against harmful effects from the ingress of water

In the Brazilian petrochemical industry, steel is used as the material for the enclosures of MV assemblies. During many years, the main classification used for switchgear assemblies was based on IEEE definitions for metal-enclosed power switchgear (a switchgear assembly completely enclosed on all sides and on top with sheet metal, containing primary power devices and possibly including control and auxiliary devices, segregated from MV conductors and structures by grounded sheet metal). The old Brazilian classification of MV assemblies was basically composed of two types: metal-clad [1] and metal-enclosed interrupter [22] (normally referred to only as "metal-enclosed" type).

An ANSI/IEEE metal-clad switchgear is characterized by:

- The main device is of drawout type
- Major parts of the primary circuit are completely enclosed by grounded metal barriers
- All live parts are enclosed within grounded metal compartments
- Automatic shutters for removable elements when they are in the disconnected, test, or removed positions
- Primary conductors and connections are covered with insulating materials
- Mechanical interlocks for proper operating sequence
- LV components and their wirings are isolated by grounded metal barriers

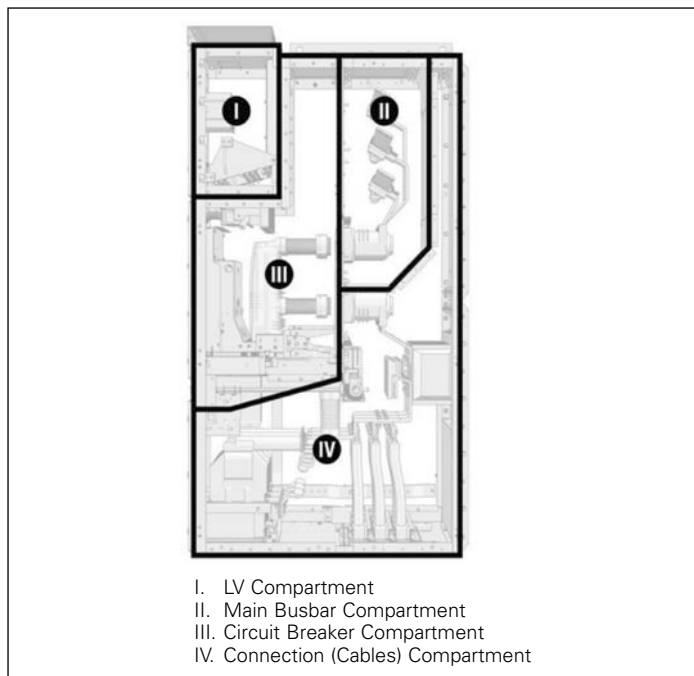

Figure 13. Compartments of a Typical Functional Unit

The third edition of IEC 60298 [18] defined three classes for a metal-enclosed assembly:

- Metal-clad (different from ANSI/IEC definition)
- Compartmented
- Cubicle

Based on IEC 60298 [18], the IEC 62271-200 [2], in its "Annex C"; presents a table describing the comparison of IEC and IEEE [14] definition of metal-clad switchgear.

Table 5. Comparison of ANSI and IEC (Based on Annex "C" of IEC 62271-200: 2003)

Description	ANSI	IEC
①	②	③
Reference	IEEE C37.20.2	IEC 60298
Compartments (power sections)	≥ 3	≥ 3
Circuit breaker	Withdrawable	Fixed allowed
Conductors	Covered by insulating materials	Bare allowed
Barriers between vertical sections for main bus	Need barriers per panel	No requirement for barriers
VT ④ / CPT ⑤	Dedicated compartment	No specific requirement
VT ④	Withdrawable	Fixed allowed
CPT ⑤	Fixed allowed but with withdrawable fuses—dedicated compartment	No specific requirement
CT ⑥	Presents a table with standard CT accuracies	No specific requirement

① Column 1: construction characteristic or component.
 ② Column 2: ANSI requirements.
 ③ Column 3: IEC requirements (based on the old IEC 60298 [8]).
 ④ VT: voltage transformers.
 ⑤ CPT: control power transformers.
 ⑥ CT: current transformers.

Differences and similarities between ANSI and IEC cultures for MV assemblies—the Brazilian experience

Since the release of the standard IEC 62271-200, there is a new approach to classify the ways that a switchgear's builders can segregate different compartments and maintain service continuity.

The LSC ("loss of service continuity") classification seeks to inform the user how far the system continuity can be kept when accessing any power (main) compartment: busbar section, cable connections, and main switching device.

The category LSC2B allows for maximum continuity of service of the system during access to any switchgear's compartment.

Another new classification is related to the type of material used as a partition between compartments (including shutters): PM (metallic partitions) or PI (insulation material). The PI also refers to situations where just part of the partition or shutter is made of insulation-covered parts. The use of a metallic partition is to avoid the presence of any electric field in the opened compartment and to eliminate any electric field change in the surrounding compartments (with the exception of the effect of the shutter changing position).

Therefore, it is possible to say that ANSI metal-clad switchgear would be classified as "LSC2B-PM" (metal-clad structure with withdrawable circuit-breaker and metallic shutters).

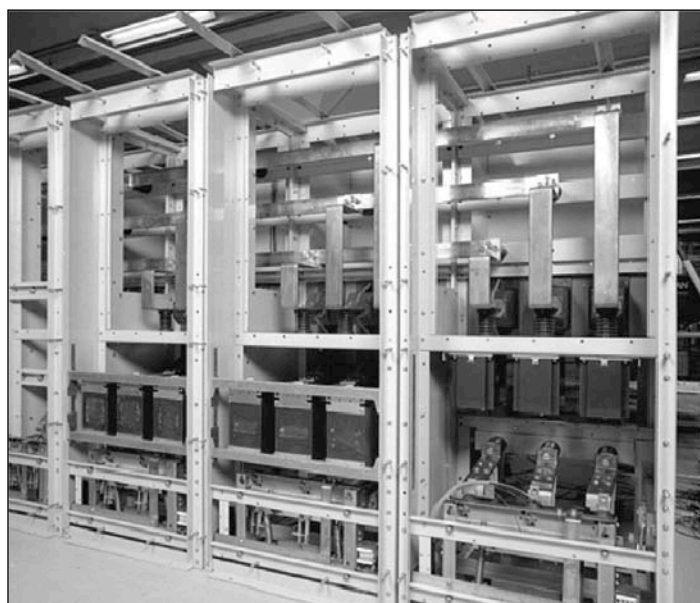

Figure 14. Internal View of Typical Sections of an IEC Metal-Enclosed Switchgear (No Barriers Between Sections, nor Busbars Covered by Insulating Materials)

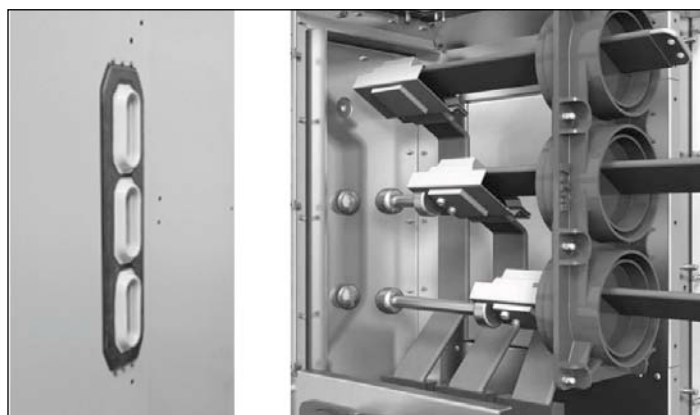

Figure 15. Examples of Main Bus Barrier for MV Switchgear and Controlgear Assemblies

In this new scenario of IEC classification, the Brazilian users decided to adopt the "LSC2B-PM" form. Besides this, because of the reliable and safe performance for many years of switchgear with ANSI-based designs, the customers also claim that any new line-up for oil and gas segments should have the following requirements in their construction:

- Dedicated interrupting (MVCB) compartment with a withdrawable CB
- Metallic shutters (automatic type) and partitions
- Insulated busbars
- Withdrawable VT
- Dedicated main busbar compartment, segregated by metallic partition
- Use of insulating bushings for buses penetrating metallic barriers
- Dedicated power cables compartment, segregated by barriers

The relatively new characteristic is the adoption of "Earthing Switches" integrated into the power circuit instead of "Ground and Testing Device" as we normally see in the ANSI culture. The integration of an internally dedicated "earthing" (grounding) switch drove the decision of switchgear designers to adopt "Voltage Detection Systems" (a combination of capacitive dividers and indicating devices) to help the user identify the presence of voltage in the cable compartment.

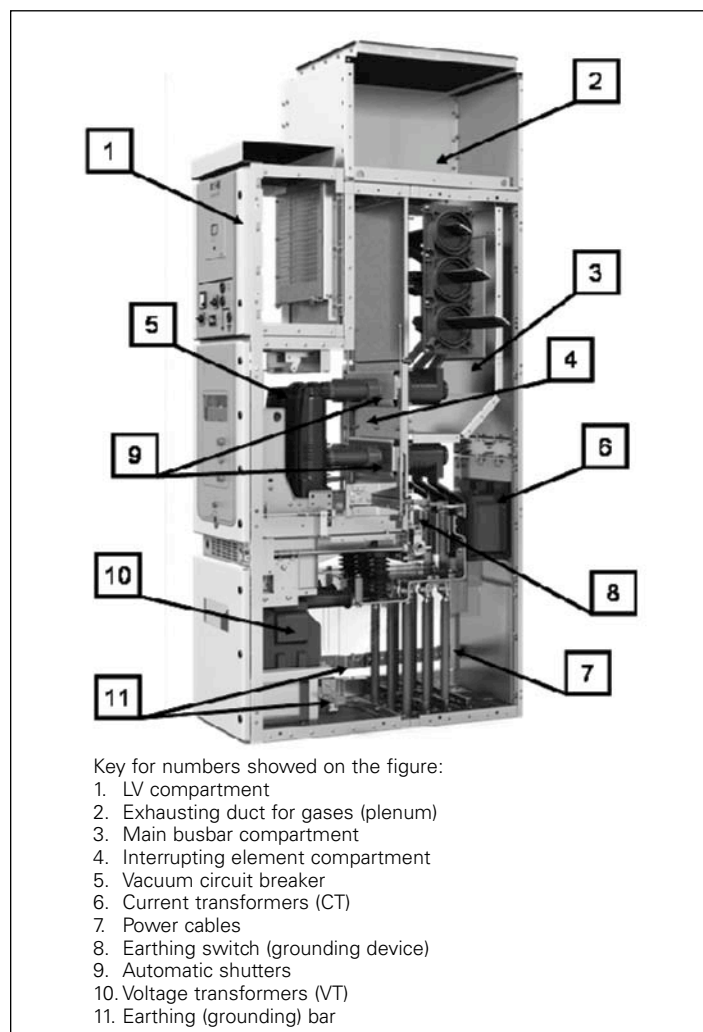

Figure 16. An Example of Modern MV Metal-Enclosed Indoor Air-Insulated Withdrawable Switchgear Unit Design Philosophy Adopted by the Brazilian Petrochemical Sector

Regarding the safety interlocks for circuit breaker cells and others parts of the column, because ANSI and IEC follow very strict rules to allow the operation of the system and interaction between components, there was no significant change in customers' requirements for such characteristics. Although an internal arc fault would not be likely to occur in any switchgear and controlgear assembly applied, erected, or used according to the standard's guidelines and manufacturer's instructions, we could not disregard such an event. So, similar to the ANSI directives for an internal arc event (see ANSI C37.20.7), the IEC (and also ABNT) has its own classification and guidelines to verify such classifications (IAC—Internal Arc Classification).

The IAC classification includes accessibility, classified sides, arc fault currents, and arc fault duration.

There are three types of accessibility:

- Type A: restricted to authorized personnel only
- Type B: unrestricted accessibility (general public)
- Type C: restricted by installation out of reach and above a general public area

The classified sides are also identified by letters (this does not apply to assemblies of accessibility type C):

- F: front side of the assembly
- L: lateral side of the assembly
- R: rear side of the assembly

In the petrochemical industry, as in any industrial electric substation, due to the safety and operation requirements, the adopted accessibility is "A" (restricted to authorized personnel only). So, the authors have identified that the most common IAC classification required for such sectors is AFLR (which would be similar to ANSI Type 2 from ANSI C37.20.7 [23]).

Regarding the arc fault current and time values, the normal practice is the adoption of the same value of the rated short-circuit current with a time duration of 1 second.

As an example, we could have an IAC classification such as "AFLR—40 kA—1 s", which is the capability to deal with an arc fault current with a symmetrical value of 40 kA for 1 second at the front, lateral, and rear sides of an assembly with accessibility restricted for authorized personnel only.

Ergonomics

A common problem in electrical panels is the height of meters, relays, and switches.

Because of the modular design, these devices are designed to be at the top of the compartment, which causes difficulty when the electrician needs to read a variable or check the reasons that a given alarm was started, particularly in installations with microprocessor-based relays [15].

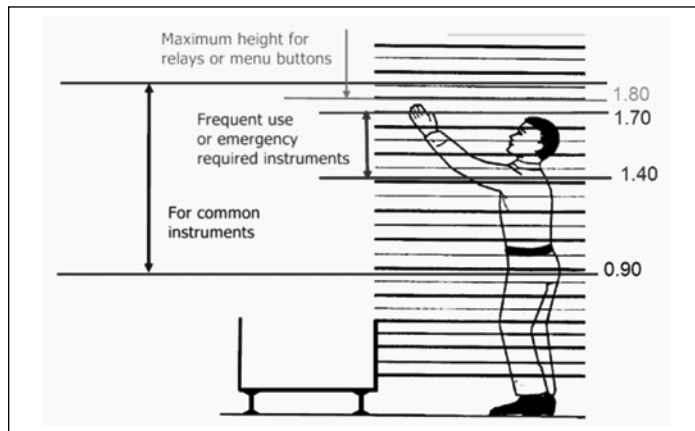

Figure 17. End User Maximum Heights for Placing Instruments in Electrical Panels, in Meters

The IEC and ANSI standards could include some requirements regarding the height for placing the relays' displays. This would make it easier for the professionals to take readings and to operate more safely.

Brazilian end users include in their specifications some requirements on ergonomics that need to be considered in a more effective way. It is clear that it is necessary to discuss the benefits of this approach related to the layout of electrical panels.

Figure 17 shows a Brazilian user specification [16] on heights for placing instruments based on ergonomics.

Conclusions

The bottom line is that the application and safe use of MV metal-enclosed switchgear assemblies demand a strong knowledge and careful analysis in each specific case.

Years of experience with ANSI standardization and technology built a strong reference for electrical professionals in the Brazilian petrochemical sector. So, when the ABNT technical committees responsible for the revision of electrical equipment standards followed the government directive to embrace the IEC, many lessons learned during years of using ANSI-based designs were brought to new MV switchgear technical specifications. Brazil is experiencing an interesting opportunity to prove the viability of increasing the efforts done in the direction of a harmonization between ANSI and IEC, especially as already seen in the area of high voltage circuit breakers.

The main Brazilian companies in the petrochemical segment have been adopting some ANSI characteristics in the technical specifications for MV switchgear that should also comply with IEC in order to improve the entire performance of the equipment. This is based on their long and positive experience with ANSI products.

The authors have seen the tendency in Brazil to enhance the minimum requirements of IEC for such equipment with the ANSI approach to improve safety and reliability.

At the end of this paper, we would also like to reinforce the importance of educating new professionals and users about the application and use of MV switchgear and controlgear assemblies.

Authors

Luiz Felipe Costa (M'2003, SM'2011) is a senior application engineer for switchgear and control products with Eaton in Rio de Janeiro, Brazil. He graduated with a degree in electrical engineering from UFRJ Engineering School and was a postgraduate and major in the protection of electrical systems at UNIFEI. He has over 27 years of experience in project, testing, application, and commissioning of switchgear and control of low and medium voltages.

Estellito Rangel Junior (M'2001, SM'2005) is a senior engineer with Petrobras in its technical support department for offshore platforms. He is member of the Brazilian Technical Standards Association (ABNT) and has been involved with standards for hazardous locations installations for over two decades. He is a Brazilian representative at IEC technical committee 31, "equipment for explosive atmospheres," and has authored previous PCIC papers.

José Maria de Carvalho Filho is a professor and a member of GEQEE (working group on electrical power quality studies) at Universidade Federal de Itajubá (UNIFEI) in Itajubá, Brazil. He has over 30 years of experience in industrial electrical power systems and power quality analysis.

Rogério Barros is the service engineering coordinator at Eaton in Rio de Janeiro, Brazil. He graduated from Universidade Veiga de Almeida and has over 20 years of experience in project, budget and quality control, manufacturing, assembly supervision, and the implementation of switchgear and control of low and medium voltages. He is currently responsible for technical sales activities for Eaton's services in Brazil.

References

1. IEEE Standard for Metal-Clad Switchgear, IEEE Std C37.20.2—1999.
2. IEC 62271-200. High-voltage switchgear and controlgear—Part 20 switchgear and controlgear for voltages above 1 kV and up to and including 52 kV. IEC; 2003.00: AC metal-enclosed
3. IEC 62271-1. High-voltage switchgear and controlgear—Part 1: Common specifications. IEC; 2007.
4. IEC 62271-100. High-voltage switchgear and controlgear—Part 100: AC circuit breakers. Edition 2.0. IEC; 2008.
5. IEC 62271-102. High-voltage switchgear and controlgear—Part 102: AC disconnectors and earthing switches. IEC.
6. IEC 62271-106. High-voltage switchgear and controlgear—Part 106: AC contactors, contactor-based controllers and motor starters. Edition 1.0. IEC; 2011.
7. IEC 60529. Degrees of protection provided by enclosures (IP Code). Edition 2.1. IEC; 2001.
8. IEC 60044-1. Instrument transformers—Part 1: Current transformers. Edition 1.2. IEC; 2003.
9. IEC 60044-2. Instrument transformers—Part 2: Inductive voltage transformers. Edition 1.2. IEC; 2003.
10. IEC 60282-1. High-voltage fuses—Part 1: Current limiting fuses. Edition 5.0. IEC; 2002.
11. ABNT NBR IEC 62271-200. High-voltage switchgear and controlgear. Part 200: AC metal enclosed switchgear and controlgear for rated voltage above 1 kV and up to and including 36.2 kV. ABNT. 2007.
12. NBR 6979. Switchgear and controlgear assemblies in metallic enclosure for rated voltage above 1 kV and up to and including 36.2 kV. ABNT; 1998.
13. IEC 60059—IEC standard current ratings. 2009.
14. IEC 60909-0—Short-circuit currents in three-phase AC systems—Part 0: Calculation of currents. 2001.
15. Rangel Jr., Estellito and Bueno, Reginaldo, "How to get an adequate electrical installation—Part II," in VIII Petrobras Electrical Engineering Seminar, 2005, Conference Record.
16. ET-3000.00-5140-700 E—General criteria for electrical design. Petrobras, 2007
17. ABNT NBR IEC 60694. Common specifications for high-voltage switchgear and controlgear standard. ABNT, 2006.
18. IEC 60298—AC metal-enclosed switchgear and controlgear for rated voltages above 1 kV and up to and including 52 kV. 1990 (third edition). It is not valid anymore. It was replaced in 2003 by [2].
19. IEEE Application Guide for AC High-Voltage Circuit Breakers Rated on a Symmetrical Current Basis, IEEE Std C37.010—1999.
20. Chudnovsky, Bella. "Degradation of Power Contacts in Industrial Atmosphere: Plating Alternative for Silver and Tin," IEEE IAS Pulp and Paper Industry Conference.
21. Das, Jay C, and Mohla, Dallep C. "Harmonization of ANSI/IEEE Standards for High-Voltage Circuit Breakers with IEC and Its Impact on Application and Analysis," 2011 IEEE IAS Pulp and Paper Industry Conference.
22. IEEE Standard for Metal-Enclosed Interrupter Switchgear, IEEE Std C37.20.3—2001.
23. IEEE Guide for Testing Metal-Enclosed Switchgear Rated up to 38 kV for Internal Arcing Faults, IEEE Std C37.20.7—2007.

[Link to IEEE original white paper.](#)

Eaton
1000 Eaton Boulevard
Cleveland, OH 44122
United States
Eaton.com

© 2014 Eaton
All Rights Reserved
Printed in USA
Publication No. WP022001EN / Z14917
February 2014