



## Power Distribution & UPS

# 3- and 4-pole switching in UPS installation

**Janne Paananen**

*Technology Manager, Critical Power Solutions, Eaton*

**Martijn Imming**

*Business Development Manager Data Centers, Eaton*

### Executive summary

In a mission-critical power supply system, choosing between 3- or 4-pole breakers affects the costs and footprint of equipment. More importantly, selecting the wrong number of poles risks safety and threatens system availability itself.

When planning for systems, it is important to consider whether the UPS will be centralized or permanently connected and to use 3- and 4-pole devices appropriately for their locations and to ensure proper functionality of electrical systems. Complicated supply arrangements may require alternative approaches to achieve correct functionality of protections and installation safety.

This white paper focuses on when to use 3- or 4-pole devices, how these impact power distribution and UPS installation, and what will improve reliability and safety, including IEC standards to comply with, and prevent unnecessary outages.



*Powering Business Worldwide*

### 3- and 4-pole switching in UPS installation

In Europe and most of the countries, low-voltage electrical installations should follow the principles of standard IEC 60364. Local regulations are based on the international standard, but can have some deviations and country specific requirements.

#### Earth reference

When earth referenced systems, such as TN-S and TN-C (Or a combination TN-C-S), are used, the system neutral should remain connected to earth reference at all times. This applies also when multiple sources are used. This will ensure proper operation and safe voltage levels in electrical installations, as well as correct functionality of protective devices (automatic disconnection of supply) during earth fault conditions.

*IEC 60364-1 Low-voltage electrical installations – Part 1: Fundamental principles, assessment of general characteristics, definitions* is giving the basic principle for the TN-S system with multiple sources. Principles are shown in Figure 7.

In a mission-critical power supply system, choosing between 3 or 4 pole breakers does affect costs and dimensions of equipment. More importantly, though, selecting the wrong pole number can create undesired ground links, causing overheating of conductors and dangerous voltage levels or a floating neutral as well as a personnel safety risk and a threat to the system availability.

For electrical systems with no UPS, the use of a 4-pole transferswitch for the building supply may be acceptable; since opening the switch will also de-energize complete downstream distribution and there's no power applied to the load. However, this is not recommended by IEC 60364. Use of 4-pole devices in downstream distribution after the main switchgear assembly and other sources, when opening these will interrupt the power to load, is preferred especially when multiple feeds and (neutral) current paths to load may exist.

### Abnormal system voltages

The requirement to follow IEC 60364 principles becomes crucial when UPS systems are used; this is primarily due to the installation and safety, not because of the UPS.

If the upstream neutral is disconnected and connection to earth reference for UPS is lost, while the UPS is supporting the load, the electrical system behaves as a floating IT-system. In this situation the system voltages, phases and neutral, may start to drift apart from earth reference. This drifting away from earth reference can be caused by stray capacitances, inductances in the electrical distribution and components, as well as possible components and connections to protective earth within loads and other equipment. A good example of these are EMI filtering components.

The magnitude of voltages seen between phases and earth, and neutral and earth, depends on previously mentioned stray components and load, and imbalance of these between phases. In worst case scenario, the system is almost "corner grounded" having one of the phases close to earth potential and other phases having line-to-line voltage towards protective earth. In this situation high voltage also exists between neutral and earth. These voltages can be harmful for the load and cause damage since the loads may have not been designed for operation in IT distribution system and may not tolerate such high voltages.

When using upstream 4-pole breakers and transfer switches in combination with a permanently connected UPS (system), the neutral conductor may have high voltage against protective earth as previously explained. Depending on location of the switch and disconnection point of the neutral, the area where hazardous voltages in neutral conductor may occur varies.

International standard *IEC 62040-1:2008 Uninterruptible power systems (UPS) – Part 1: General and safety requirements for UPS* gives the specific safety requirements for UPS products and installation. According to standard, warning labels shall be fitted on all primary power isolators and access points between such isolators and the UPS, by the user, when the UPS supply is connected through 4-pole devices that will interrupt the neutral when opened, or when the UPS is connected to an IT power distribution system. The purpose of these is to warn the electrical service person about possible voltage backfeed, in this context a hazardous voltage in neutral conductor created by energized and floating electrical system.

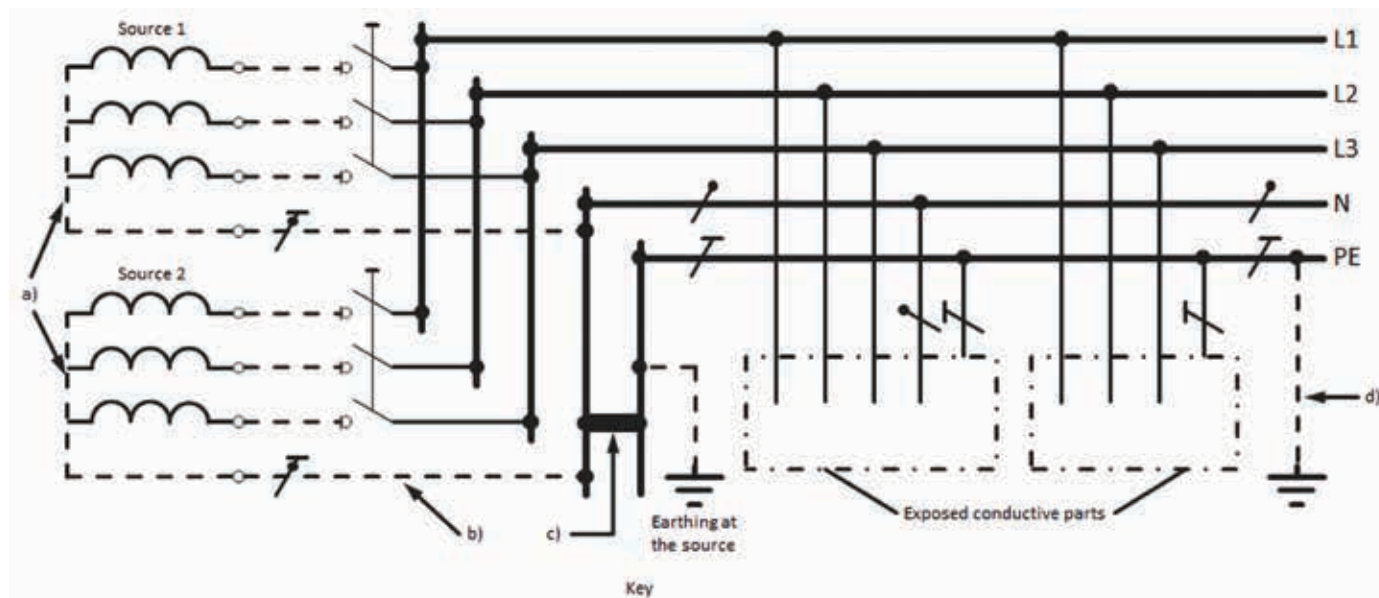

- a) No direct connection from either the transformer neutral point or the generator star point to earth is permitted.
- b) The interconnection conductor between either the neutral points of the transformers or the generator star points shall be insulated. The function of this conductor is like a PEN; however, it shall not be connected to current-using equipment.
- c) Only one connection between the interconnected neutral points of the sources and the PE shall be provided. This connection shall be located inside the main switchgear assembly.
- d) Additional earthing of the PE in the installation may be provided.

Figure 1: Multiple source system following the principles of international standard for low-voltage electrical installations.

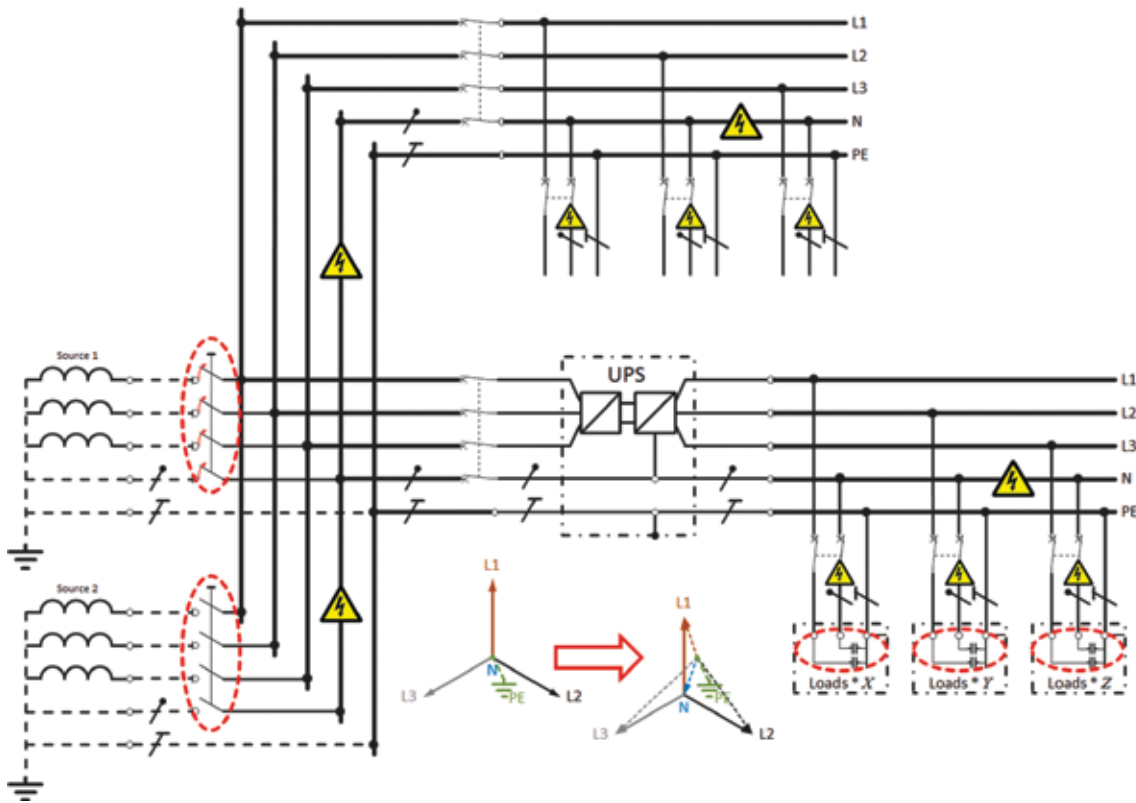

Figure 2: When a 4-pole device is opened upstream a permanently connected UPS, the neutral voltage may drift apart from earth potential and neutral becomes hazardous. Existence of this neutral voltage in installation depends on disconnection point of neutral upstream a UPS.

#### Earth fault in stored energy mode and automatic disconnection of supply

Due to potential safety risks for the load and service personnel by the abnormal system voltages, use of 4-pole switching devices upstream a permanently connected UPS's shall be avoided. But this is not the only reason. Automatic disconnection of supply is one of the fundamental safety requirements for low-voltage electrical installations to avoid creation of touch voltages and to ensure safety of persons.

When the 4-pole switch upstream a UPS is open, and UPS operates in stored energy mode, the connection to earth reference is lost and also the return path for earth fault current is cut-off. If an earth fault downstream of a UPS occurs, the inverters cannot feed fault current to trip the overcurrent protection and the requirement for automatic disconnection of supply is not met.

Instead the system becomes "corner grounded", since one of the phases is connected to protective earth through a fault impedance, resulting potentially hazardous voltages throughout the system as other phases and neutral drift apart from earth potential.

Correct system earthing following principles of IEC 60364-1 is shown in Figure 1. This ensures correct operation of overcurrent protection in all operational modes and avoids creation of abnormal voltages into electrical system due to floating neutral.

**Before working on this circuit**

- Isolate Uninterruptible Power System (UPS)
- Then check for Hazardous Voltage between all terminals including the protective earth



**Risk of Voltage Backfeed**

Figure 3: Warning sticker as described in IEC 62040-1:2008 that shall be used in case of external backfeed protection devices and when 4-pole switches are used upstream a permanently connected UPS.



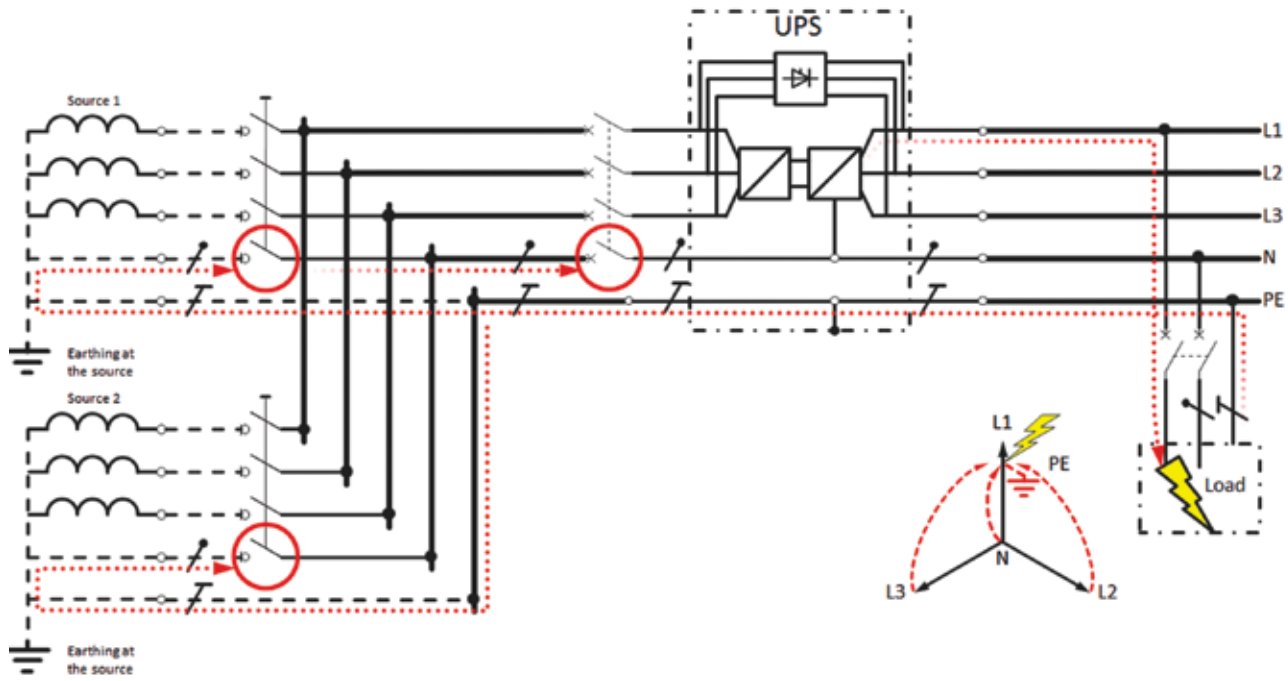

Figure 4: Current path for earth fault current in UPS stored energy mode shown with red dotted line. Possible locations for interruption of fault current path, when 4-pole devices used upstream of permanently connected UPS, are circled red in above circuit diagram. These devices, when open, will prevent operation of load overcurrent protection and automatic disconnection of supply.

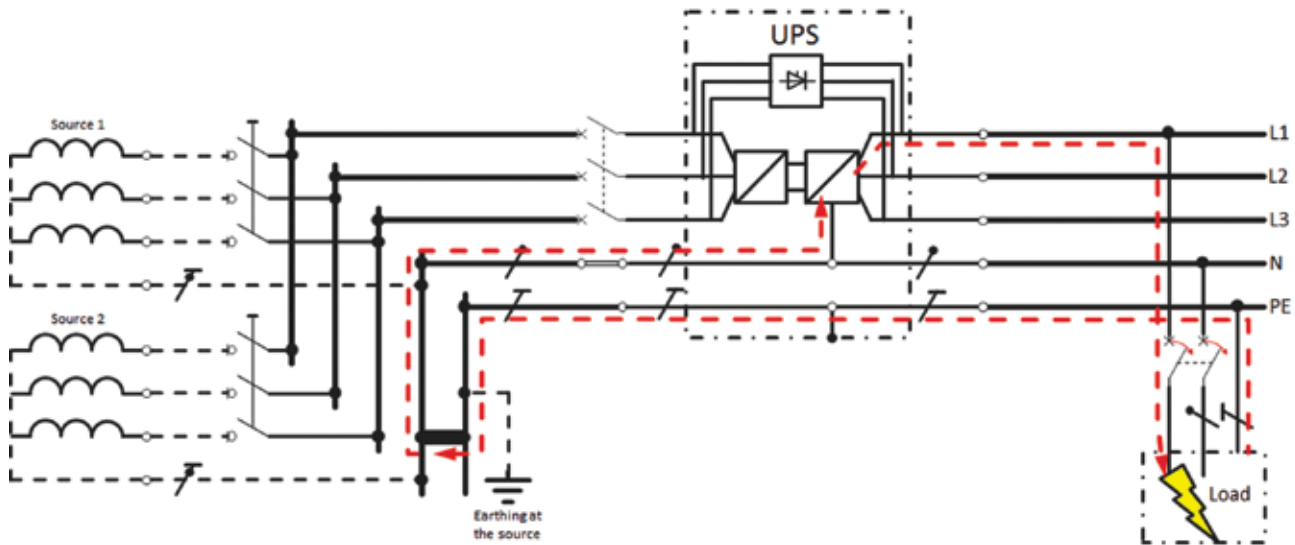

Figure 5: Current path for earth fault current in UPS stored energy mode shown in dotted red line. Above example follows the principles of international standard for low-voltage electrical installations for TN-(C-)S system with multiple sources.

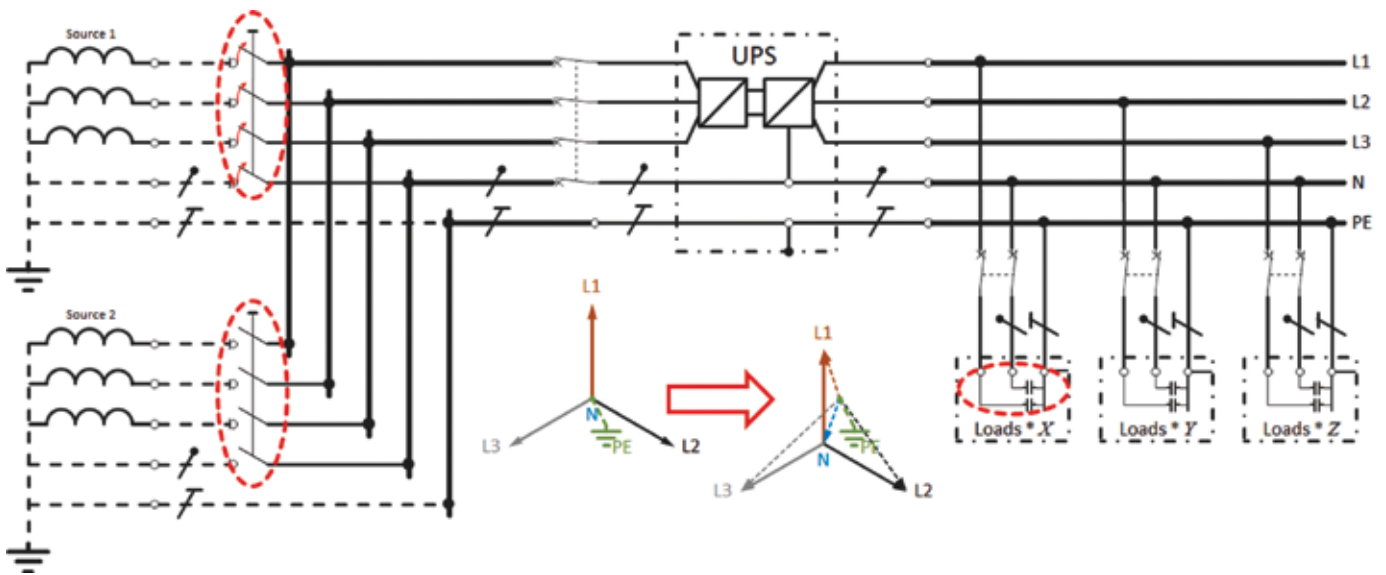

Figure 6: Opening of 4-pole transfer switch upstream a UPS makes the electrical distribution system to operate as a non-earth-referenced IT network and system voltages may drift apart from earth reference.

### Nuisance tripping of residual current devices

Beside discussed safety hazards, multiple cases are known where opening and closure of the 4-pole transfer switches in building supply has caused nuisance tripping of residual current circuit breakers (RCCB).

During the transfer sequence from a source to another, when both breakers are open, the system is temporarily an IT distribution system. The voltages may drift apart from earth reference due to stray capacitances and inductances of the system, and due to for example EMI filters. Any imbalance in the "leakage impedances" to protective earth among phases causes the system to drift.

Once the transfer is completed, and the breaker are closed, the neutral is connected back to earth reference, creating sudden change of voltages, a fast transient current, between phases and neutral towards protective earth. This can cause EMI filters of the load to create a current transient into protective earth conductor due fast charge or discharge of EMI filtering capacitors. When there's lots of these loads, overall transient current can be enough to trip residual current protective devices.

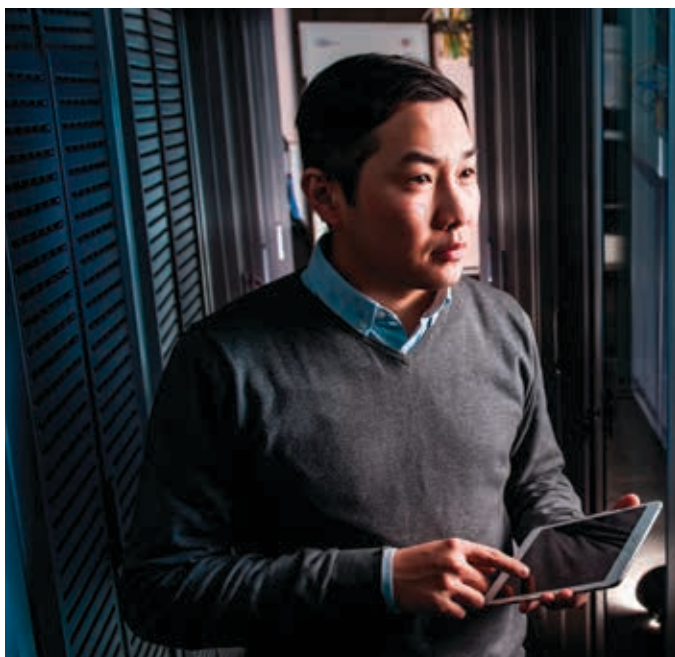

### Summarizing 3- and 4-pole device use

For multiple feeds, 3-pole transfer switches shall be used for both generator and transformer source incomers. Both sources are connected to a mains switchboard, or change-over panel, with 3 phases and PEN conductor. The PE and N are separated in the main switchboard and a TN-S system is used from this point forward. The neutral must be connected reliably into earth reference at all times whenever power is applied to the load.

When planning for systems with centralized, or permanently connected, UPS systems, it is important to use 3- and 4-pole devices appropriately for their locations and to ensure proper functionality of electrical system. Complicated supply arrangements, if present, may require some alternative approaches, such as use of a separate N-PE switching device with ATS, to achieve correct functionality of protections and installation safety.

When alternative approaches for neutral switching are considered, careful analysis shall be done to verify proper functionality in various system states. One shall take account not only the normal operation of the system, but also possible fault scenarios and component failures, and to ensure the electrical system and equipment remain safe for environment and personnel. If, for example, additional temporary N – PE links are created in downstream installation by switching devices, these may need to be rated for full system fault current, rather than on nominal current of the specific circuit.

The configuration required at each feeder position is summarized in table below.

Feeder	Full name	Poles	Neutral	Rating
MS	Mains (Transformer) Supply	3	Fixed (PEN)	Full electrical system load
GS	Generator Supply	3	Fixed (PEN)	Full electrical system load
MOB	Module Output Breaker	4	Switched	UPS unit nominal current
RIB	Rectifier Input Breaker	3	Removable	Rectifier maximum current
BIB	Bypass Input Breaker	3	Removable	UPS unit nominal current
MBS	Maintenance Bypass Switch	4	Switched	UPS system load current
MIS	Maintenance Isolation Switch	4	Switched	UPS system load current
LBB	Load Bank Breaker	4	Switched	Load bank size
LDB	Load Distribution Breaker	4	Switched	Load branch current

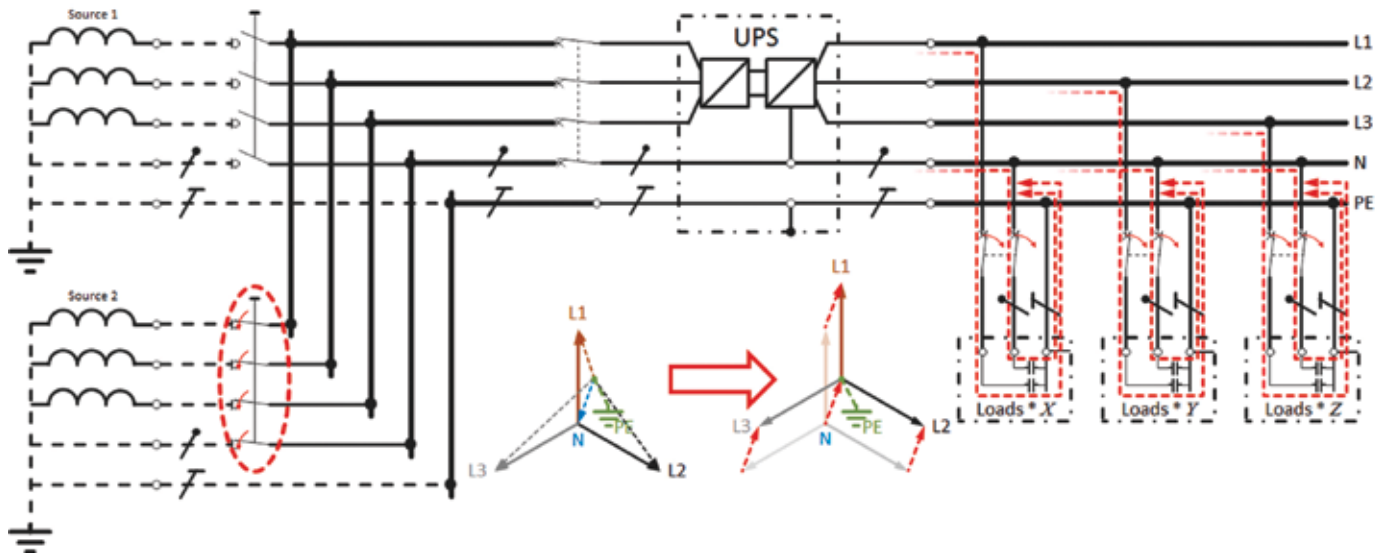

Figure 7: Closure of 4-pole transfer switch may cause current transients to system due to fast voltage transient. This may lead into nuisance tripping of residual current protection.

### Conclusions

Making the correct choices between 3- and 4-pole switching has consequences for system reliability, safety and regulatory compliance, not to mention cost. It is important to consider the best balance between compliance, safety and economy, as well as looking for further opportunities for greater economy from optimal breaker sizing.

Choosing the wrong pole number can create unintended risks and consequences, from undesired ground links, overheating of conductors and dangerous voltage levels or a floating neutral, nuisance tripping of circuit breakers, through to affecting the safety of data center personnel and even threatening system availability.

Making the correct the choice that strikes the right balance between availability, safety and cost in a power distribution system, especially where UPSs are involved, is a complex calculation. With these considerations in mind, the advantages of consulting with knowledgeable experts from companies such as Eaton, backed by a long-established international reputation and an extensive selection of UPS and switchgear components of proven interoperability, are clear.



